

Thunderbolt IGBT™ & FRED

The Thunderbolt IGBT™ is a new generation of high voltage power IGBTs. Using Non-Punch Through Technology the Thunderbolt IGBT™ combined with an APT free-wheeling ultraFast Recovery Epitaxial Diode (FRED) offers superior ruggedness and ultrafast switching speed.

- Low Forward Voltage Drop
- Low Tail Current
- Avalanche Rated
- Ultrafast Soft Recovery Antiparallel Diode
- High Freq. Switching to 150KHz
- Ultra Low Leakage Current
- RBSOA and SCSOA Rated

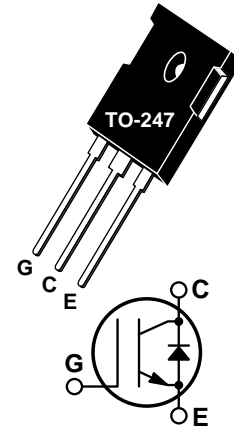

MAXIMUM RATINGS (IGBT)

All Ratings: $T_C = 25^\circ\text{C}$ unless otherwise specified.

Symbol	Parameter	APT15GT60BRD	UNIT
V_{CES}	Collector-Emitter Voltage	600	Volts
V_{CGR}	Collector-Gate Voltage ($R_{GE} = 20K\Omega$)	600	
V_{GE}	Gate-Emitter Voltage	± 20	
I_{C1}	Continuous Collector Current @ $T_C = 25^\circ\text{C}$	30	Amps
I_{C2}	Continuous Collector Current @ $T_C = 110^\circ\text{C}$	15	
I_{CM1}	Pulsed Collector Current ^① @ $T_C = 25^\circ\text{C}$	60	
I_{CM2}	Pulsed Collector Current ^① @ $T_C = 110^\circ\text{C}$	30	
E_{AS}	Single Pulse Avalanche Energy ^②	24	mJ
P_D	Total Power Dissipation	125	Watts
T_J, T_{STG}	Operating and Storage Junction Temperature Range	-55 to 150	$^\circ\text{C}$
T_L	Max. Lead Temp. for Soldering: 0.063" from Case for 10 Sec.	300	

STATIC ELECTRICAL CHARACTERISTICS (IGBT)

Symbol	Characteristic / Test Conditions	MIN	TYP	MAX	UNIT
BV_{CES}	Collector-Emitter Breakdown Voltage ($V_{GE} = 0V, I_C = 0.5mA, T_j = -55^\circ\text{C}$)	600			Volts
$V_{GE(TH)}$	Gate Threshold Voltage ($V_{CE} = V_{GE}, I_C = 700\mu A, T_j = 25^\circ\text{C}$)	3	4	5	
$V_{CE(ON)}$	Collector-Emitter On Voltage ($V_{GE} = 15V, I_C = I_{C2}, T_j = 25^\circ\text{C}$)	1.6	2.0	2.5	
	Collector-Emitter On Voltage ($V_{GE} = 15V, I_C = I_{C2}, T_j = 150^\circ\text{C}$)			2.8	
I_{CES}	Collector Cut-off Current ($V_{CE} = V_{CES}, V_{GE} = 0V, T_j = 25^\circ\text{C}$)			40	μA
	Collector Cut-off Current ($V_{CE} = V_{CES}, V_{GE} = 0V, T_j = 150^\circ\text{C}$)			200	
I_{GES}	Gate-Emitter Leakage Current ($V_{GE} = \pm 25V, V_{CE} = 0V$)			± 100	nA

CAUTION: These Devices are Sensitive to Electrostatic Discharge. Proper Handling Procedures Should Be Followed.

USA
405 S.W. Columbia Street

EUROPE
Avenue J.F. Kennedy Bât B4 Parc Cadéra Nord

APT Website - <http://www.advancedpower.com>

Bend, Oregon 97702-1035

Phone: (541) 382-8028

FAX: (541) 388-0364

F-33700 Merignac - France

Phone: (33) 5 57 92 15 15

FAX: (33) 5 56 47 97 61

DYNAMIC CHARACTERISTICS (IGBT)

APT15GT60BRD

Symbol	Characteristic	Test Conditions	MIN	TYP	MAX	UNIT
C _{ies}	Input Capacitance	Capacitance V _{GE} = 0V V _{CE} = 25V f = 1 MHz		825		pF
C _{oes}	Output Capacitance			90		
C _{res}	Reverse Transfer Capacitance			52		
Q _g	Total Gate Charge ^③	Gate Charge V _{GE} = 15V V _{CC} = 0.66V _{CES} I _C = 0.8I _{C2}		53		nC
Q _{ge}	Gate-Emitter Charge			37		
Q _{gc}	Gate-Collector ("Miller") Charge			7		
t _{d(on)}	Turn-on Delay Time	Resistive Switching (25°C) V _{GE} = 15V V _{CC} = 0.66V _{CES} I _C = 0.8I _{C2} R _G = 5Ω		6		ns
t _r	Rise Time			18		
t _{d(off)}	Turn-off Delay Time			48		
t _f	Fall Time			78		
t _{d(on)}	Turn-on Delay Time	Inductive Switching (150°C) V _{CLAMP(Peak)} = 0.66V _{CES} V _{GE} = 15V I _C = 0.8I _{C2} R _G = 5Ω T _J = +150°C		13		ns
t _r	Rise Time			34		
t _{d(off)}	Turn-off Delay Time			84		
t _f	Fall Time			55		
E _{on}	Turn-on Switching Energy ^④			0.29		mJ
E _{off}	Turn-off Switching Energy			0.29		
E _{ts}	Total Switching Losses ^④			0.58		
t _{d(on)}	Turn-on Delay Time	Inductive Switching (25°C) V _{CLAMP(Peak)} = 0.66V _{CES} V _{GE} = 15V I _C = 0.8I _{C2} R _G = 5Ω T _J = +25°C		13		ns
t _r	Rise Time			35		
t _{d(off)}	Turn-off Delay Time			73		
t _f	Fall Time			34		
E _{ts}	Total Switching Losses ^④			0.45		mJ
g _{fe}	Forward Transconductance	V _{CE} = 20V, I _C = I _{C2}	3			S

THERMAL AND MECHANICAL CHARACTERISTICS (IGBT and FRED)

Symbol	Characteristic	MIN	TYP	MAX	UNIT
R _{θJC}	Junction to Case (IGBT)			1.0	°C/W
	Junction to Case (FRED)			2.0	
R _{θJA}	Junction to Ambient			40	
W _T	Package Weight		0.22		oz
			6.1		gm
Torque	Mounting Torque using a 6-32 or 3mm Binding Head Machine Screw			10	lb•in
				1.1	N•m

① Repetitive Rating: Pulse width limited by maximum junction temperature.

② I_C = I_{C2}, V_{CC} = 50V, R_{GE} = 25Ω, L = 200μH, T_J = 25°C

③ See MIL-STD-750 Method 3471

④ Switching losses include the FRED and IGBT.

APT Reserves the right to change, without notice, the specifications and information contained herein.

ULTRAFast SOFT RECOVERY PARALLEL DIODE

MAXIMUM RATINGS (FRED)

All Ratings: $T_C = 25^\circ\text{C}$ unless otherwise specified.

Symbol	Characteristic / Test Conditions	APT15GT60BRD	UNIT
V_R	Maximum D.C. Reverse Voltage	600	Volts
V_{RRM}	Maximum Peak Repetitive Reverse Voltage		
V_{RWM}	Maximum Working Peak Reverse Voltage		
$I_F(AV)$	Maximum Average Forward Current ($T_C = 90^\circ\text{C}$, Duty Cycle = 0.5)	15	Amps
$I_F(RMS)$	RMS Forward Current	25	
I_{FSM}	Non-Repetitive Forward Surge Current ($T_J = 45^\circ\text{C}$, 8.3ms)	110	

STATIC ELECTRICAL CHARACTERISTICS (FRED)

Symbol	Characteristic / Test Conditions	MIN	TYP	MAX	UNIT
V_F	Maximum Forward Voltage		1.6	$I_F = 15A$	1.8
				$I_F = 30A$	
				$I_F = 15A, T_J = 150^\circ\text{C}$	1.6
I_{RM}	Maximum Reverse Leakage Current			$V_R = V_R$ Rated	150
				$V_R = V_R$ Rated, $T_J = 125^\circ\text{C}$	500
L_S	Series Inductance (Lead to Lead 5mm from Base)		10		nH

DYNAMIC CHARACTERISTICS (FRED)

Symbol	Characteristic	MIN	TYP	MAX	UNIT
t_{rr1}	Reverse Recovery Time, $I_F = 1.0A, di_F/dt = -15A/\mu s, V_R = 30V, T_J = 25^\circ\text{C}$		40	50	ns
t_{rr2}	Reverse Recovery Time		40		
t_{rr3}	$I_F = 15A, di_F/dt = -100A/\mu s, V_R = 350V$		80		
t_{fr1}	Forward Recovery Time		170		Volts
t_{fr2}	$I_F = 15A, di_F/dt = 100A/\mu s, V_R = 350V$		170		
I_{RRM1}	Reverse Recovery Current		2.5	5	Amps
I_{RRM2}	$I_F = 15A, di_F/dt = -100A/\mu s, V_R = 350V$		3	6	
Q_{rr1}	Recovery Charge		50		nC
Q_{rr2}	$I_F = 15A, di_F/dt = -100A/\mu s, V_R = 350V$		120		
V_{fr1}	Forward Recovery Voltage		2.2		Volts
V_{fr2}	$I_F = 15A, di_F/dt = 100A/\mu s, V_R = 350V$		2.2		
diM/dt	Rate of Fall of Recovery Current		200		A/ μs
	$I_F = 15A, di_F/dt = -100A/\mu s, V_R = 350V$ (See Figure 10)		100		

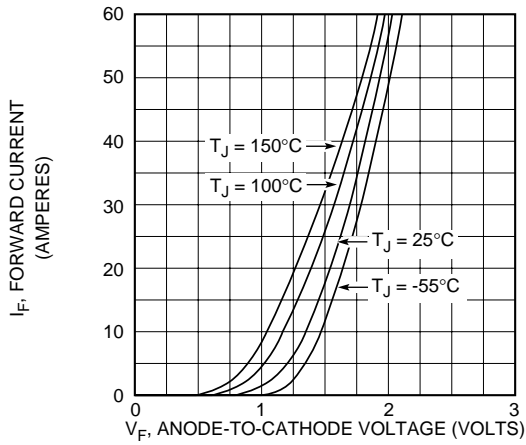

Figure 1, Forward Voltage Drop vs Forward Current

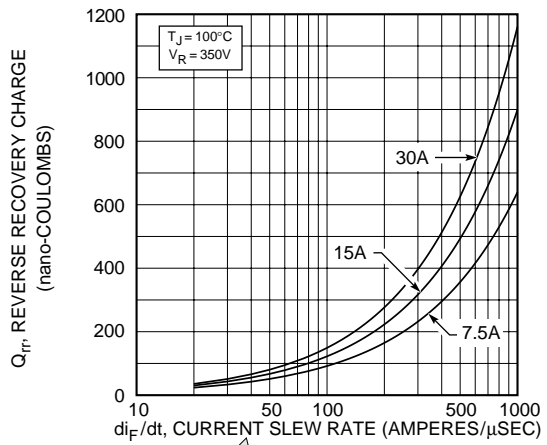

Figure 2, Reverse Recovery Charge vs Current Slew Rate

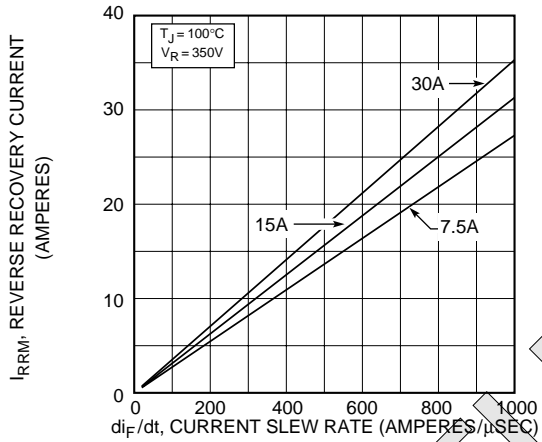

Figure 3, Reverse Recovery Current vs Current Slew Rate

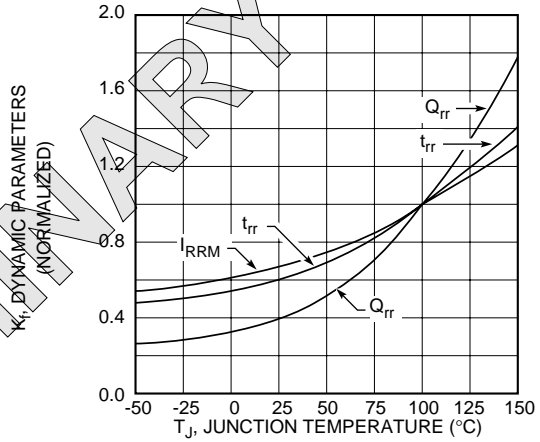

Figure 4, Dynamic Parameters vs Junction Temperature

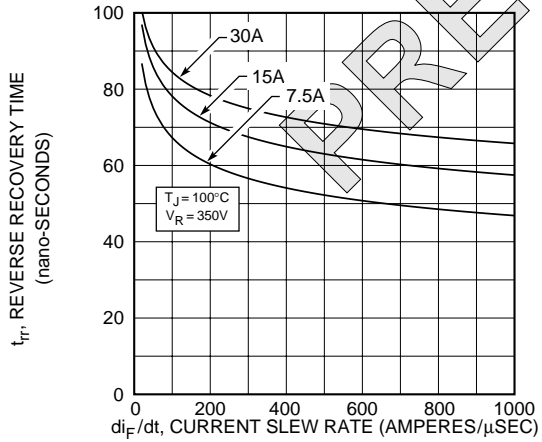

Figure 5, Reverse Recovery Time vs Current Slew Rate

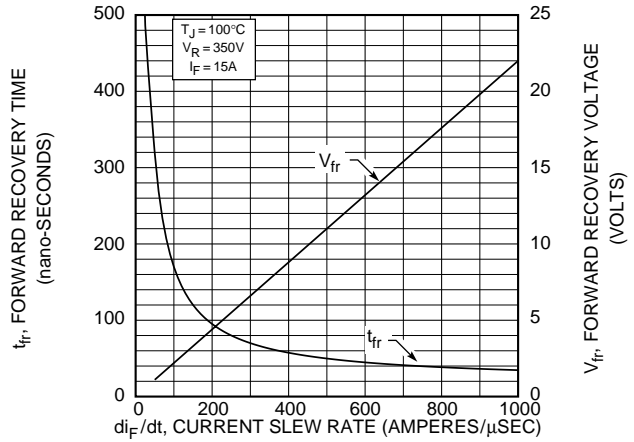

Figure 6, Forward Recovery Voltage/Time vs Current Slew Rate

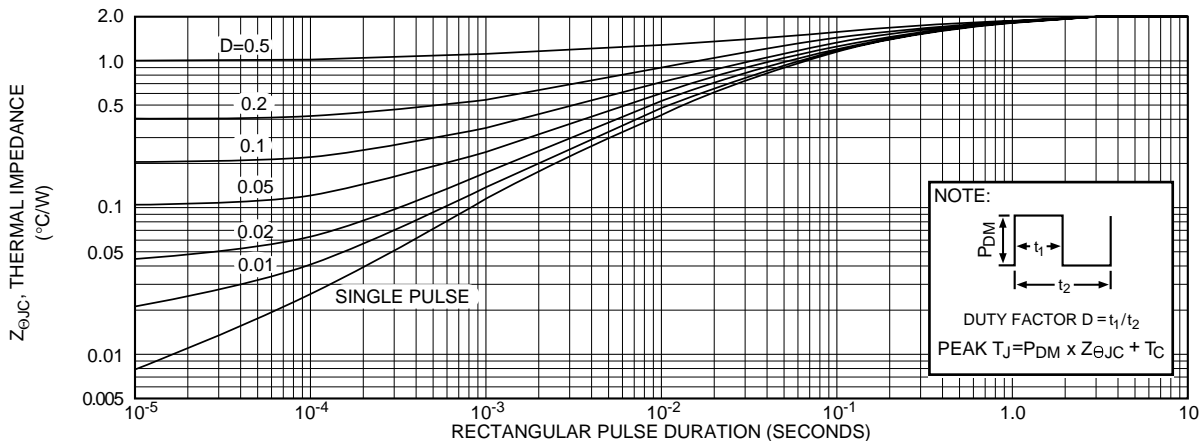

Figure 7, Maximum Effective Transient Thermal Impedance, Junction-To-Case vs Pulse Duration

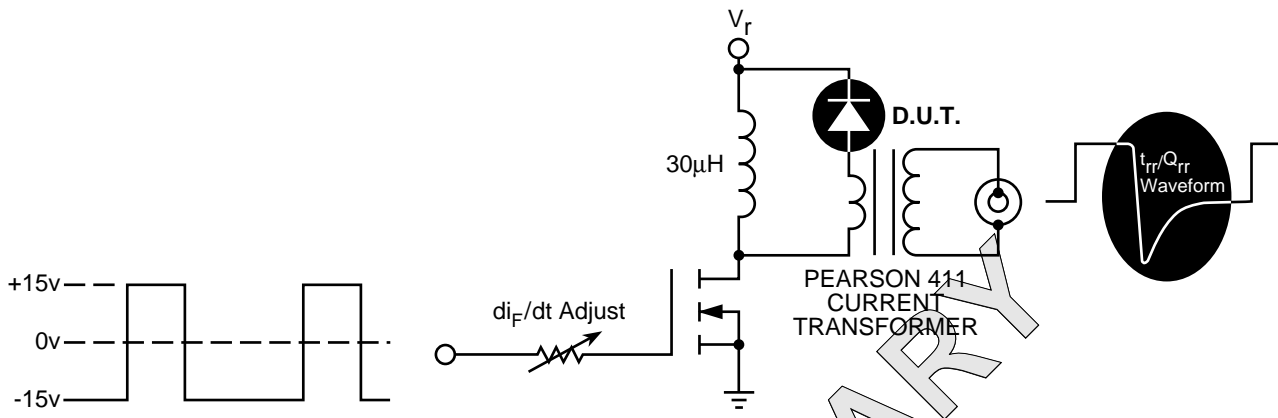

Figure 25, Diode Reverse Recovery Test Circuit and Waveforms

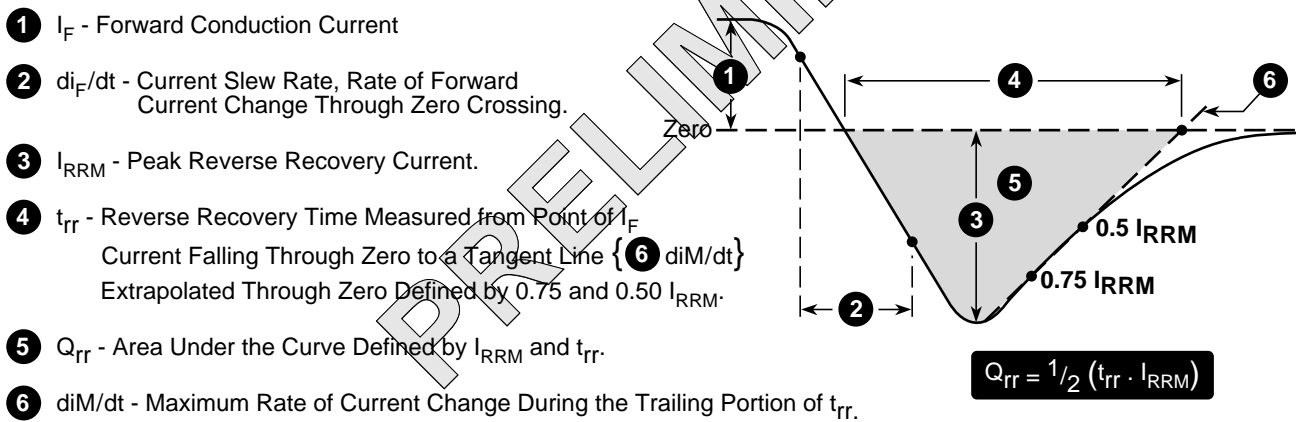

Figure 8, Diode Reverse Recovery Waveform and Definitions

TO-247 Package Outline

