

Fast IGBT & FRED

The Fast IGBT™ is a new generation of high voltage power IGBTs. Using Non-Punch Through™ Technology the Fast IGBT™ combined with an APT free-wheeling ultraFast Recovery Epitaxial Diode (FRED) offers superior ruggedness and fast switching speed.

- Low Forward Voltage Drop
- Low Tail Current
- RBSOA and SCSOA Rated
- Ultrafast Soft Recovery Antiparallel Diode
- High Freq. Switching to 20KHz
- Ultra Low Leakage Current

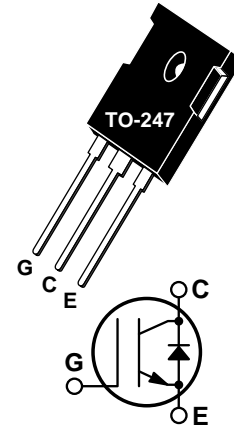

MAXIMUM RATINGS (IGBT)

All Ratings: $T_C = 25^\circ\text{C}$ unless otherwise specified.

Symbol	Parameter	APT20GF120BRD	UNIT
V_{CES}	Collector-Emitter Voltage	1200	Volts
V_{CGR}	Collector-Gate Voltage ($R_{GE} = 20\text{K}\Omega$)	1200	
V_{GE}	Gate-Emitter Voltage	± 20	
I_{C1}	Continuous Collector Current @ $T_C = 25^\circ\text{C}$	32	Amps
I_{C2}	Continuous Collector Current @ $T_C = 90^\circ\text{C}$	20	
I_{CM1}	Pulsed Collector Current ^① @ $T_C = 25^\circ\text{C}$	64	
I_{CM2}	Pulsed Collector Current ^① @ $T_C = 90^\circ\text{C}$	40	
P_D	Total Power Dissipation	200	Watts
T_J, T_{STG}	Operating and Storage Junction Temperature Range	-55 to 150	$^\circ\text{C}$
T_L	Max. Lead Temp. for Soldering: 0.063" from Case for 10 Sec.	300	

STATIC ELECTRICAL CHARACTERISTICS (IGBT)

Symbol	Characteristic / Test Conditions	MIN	TYP	MAX	UNIT
BV_{CES}	Collector-Emitter Breakdown Voltage ($V_{GE} = 0\text{V}, I_C = 1.0\text{mA}$)	1200			Volts
$V_{GE(TH)}$	Gate Threshold Voltage ($V_{CE} = V_{GE}, I_C = 350\mu\text{A}, T_J = 25^\circ\text{C}$)	4.5	5.5	6.5	
$V_{CE(ON)}$	Collector-Emitter On Voltage ($V_{GE} = 15\text{V}, I_C = 15\text{A}, T_J = 25^\circ\text{C}$)		2.7	3.2	
	Collector-Emitter On Voltage ($V_{GE} = 15\text{V}, I_C = 15\text{A}, T_J = 125^\circ\text{C}$)		3.3	3.9	
I_{CES}	Collector Cut-off Current ($V_{CE} = V_{CES}, V_{GE} = 0\text{V}, T_J = 25^\circ\text{C}$)			1.0	mA
	Collector Cut-off Current ($V_{CE} = V_{CES}, V_{GE} = 0\text{V}, T_J = 125^\circ\text{C}$)			6.0	
I_{GES}	Gate-Emitter Leakage Current ($V_{GE} = \pm 20\text{V}, V_{CE} = 0\text{V}$)			± 100	nA

 **CAUTION:** These Devices are Sensitive to Electrostatic Discharge. Proper Handling Procedures Should Be Followed.

USA
405 S.W. Columbia Street

EUROPE
Avenue J.F. Kennedy Bât B4 Parc Cadéra Nord

APT Website - <http://www.advancedpower.com>

Bend, Oregon 97702-1035

Phone: (541) 382-8028

FAX: (541) 388-0364

F-33700 Merignac - France

Phone: (33) 5 57 92 15 15

FAX: (33) 5 56 47 97 61

DYNAMIC CHARACTERISTICS (IGBT)

APT20GF120BRD

Symbol	Characteristic	Test Conditions	MIN	TYP	MAX	UNIT
C _{ies}	Input Capacitance	Capacitance V _{GE} = 0V V _{CE} = 25V f = 1 MHz		1100	1500	pF
C _{oes}	Output Capacitance			165	250	
C _{res}	Reverse Transfer Capacitance			70	100	
Q _g	Total Gate Charge ^②	Gate Charge V _{GE} = 15V V _{CC} = 0.5V _{CES} I _C = I _{C2}		95	150	nC
Q _{ge}	Gate-Emitter Charge			13	20	
Q _{gc}	Gate-Collector ("Miller") Charge			55	85	
t _{d(on)}	Turn-on Delay Time	Resistive Switching (25°C) V _{GE} = 15V V _{CC} = 0.8V _{CES} I _C = I _{C2} R _G = 10Ω		17		ns
t _r	Rise Time			75		
t _{d(off)}	Turn-off Delay Time			99		
t _f	Fall Time			170		
t _{d(on)}	Turn-on Delay Time	Inductive Switching (150°C) V _{CLAMP(Peak)} = 0.66V _{CES} V _{GE} = 15V I _C = I _{C2} R _G = 10Ω T _J = +150°C		20	30	ns
t _r	Rise Time			35	70	
t _{d(off)}	Turn-off Delay Time			190	275	
t _f	Fall Time			90	135	
E _{on}	Turn-on Switching Energy ^③			1.2		
E _{off}	Turn-off Switching Energy		1.8			
E _{ts}	Total Switching Losses ^③		3.0			
t _{d(on)}	Turn-on Delay Time	Inductive Switching (25°C) V _{CLAMP(Peak)} = 0.66V _{CES} V _{GE} = 15V I _C = I _{C2} R _G = 10Ω T _J = +25°C		20		ns
t _r	Rise Time			35		
t _{d(off)}	Turn-off Delay Time			160		
t _f	Fall Time			90		
E _{ts}	Total Switching Losses ^③			2.7		
g _{fe}	Forward Transconductance	V _{CE} = 20V, I _C = 15A		12		S

THERMAL AND MECHANICAL CHARACTERISTICS (IGBT and FRED)

Symbol	Characteristic	MIN	TYP	MAX	UNIT
R _{θJC}	Junction to Case (IGBT)			0.63	°C/W
	Junction to Case (FRED)			0.90	
R _{θJA}	Junction to Ambient			40	
W _T	Package Weight		0.22		oz
			6.1		gm
Torque	Mounting Torque using a 6-32 or 3mm Binding Head Machine Screw			10	lb•in
				1.1	N•m

① Repetitive Rating: Pulse width limited by maximum junction temperature.

② See MIL-STD-750 Method 3471

③ Switching losses include the FRED and IGBT.

APT Reserves the right to change, without notice, the specifications and information contained herein.

Power dissipation

$$P_{tot} = f(T_C)$$

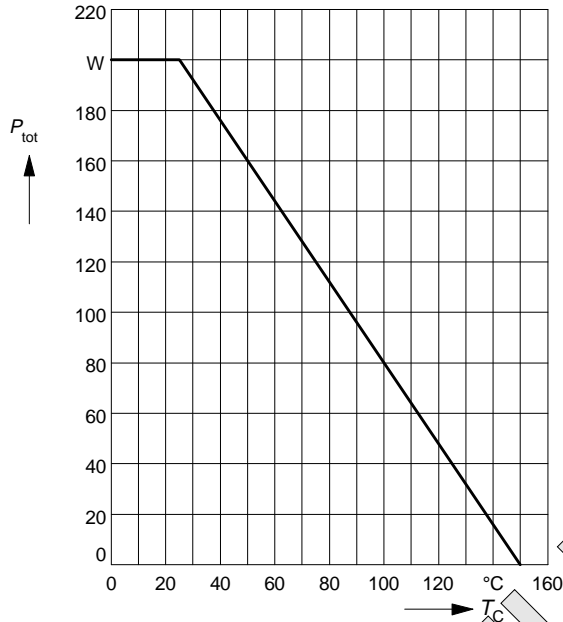
 parameter: $T_j \leq 150\text{ }^\circ\text{C}$

Collector current

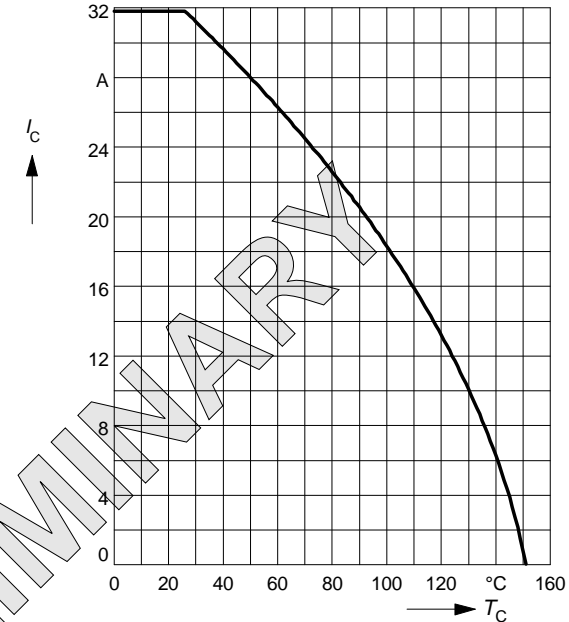
$$I_C = f(T_C)$$

 parameter: $V_{GE} \geq 15\text{ V}$, $T_j \leq 150\text{ }^\circ\text{C}$

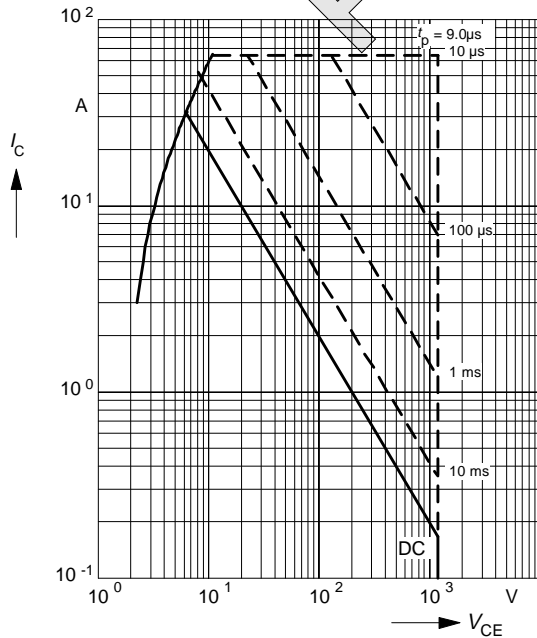
Safe operating area

$$I_C = f(V_{CE})$$

 parameter: $D = 0$, $T_C = 25\text{ }^\circ\text{C}$, $T_j \leq 150\text{ }^\circ\text{C}$

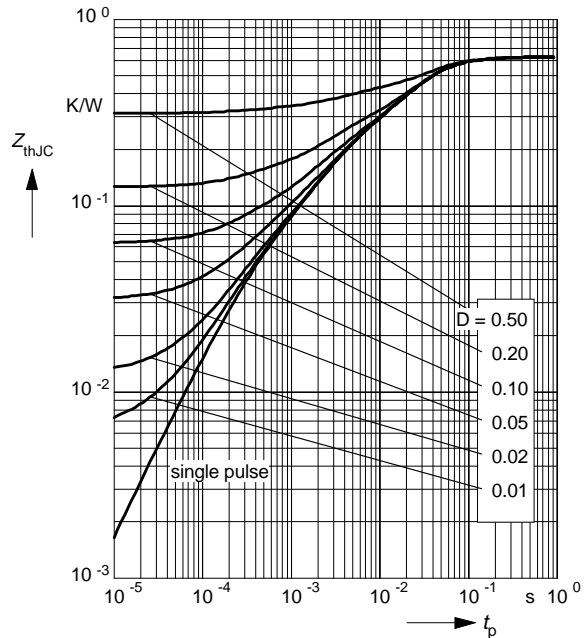
Transient thermal impedance IGBT

$$Z_{thJC} = f(t_p)$$

 parameter: $D = t_p / T$

EUROPE

 Avenue J.F. Kennedy Bât B4 Parc Cadéra Nord
USA

405 S.W. Columbia Street

F-33700 Merignac - France

Bend, Oregon 97702-1035

Phone: (33) 5 57 92 15 15

Phone: (541) 382-8028

FAX: (33) 5 56 47 97 61

FAX: (541) 388-0364

Typ. gate charge

$$V_{GE} = f(Q_{Gate})$$

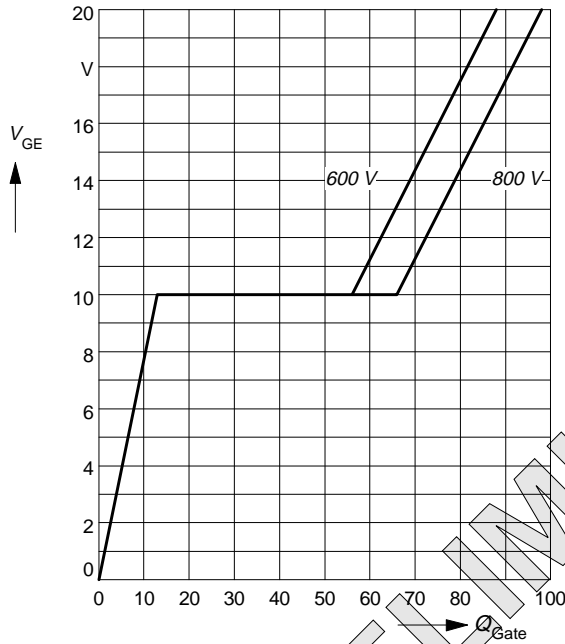
 parameter: $I_{C\ puls} = 16A$

Typ. capacitances

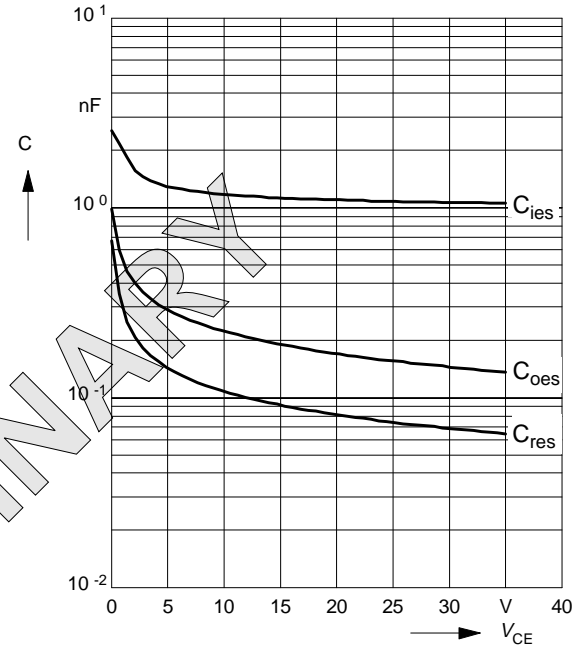
$$C = f(V_{CE})$$

 parameter: $V_{GE} = 0V, f = 1MHz$

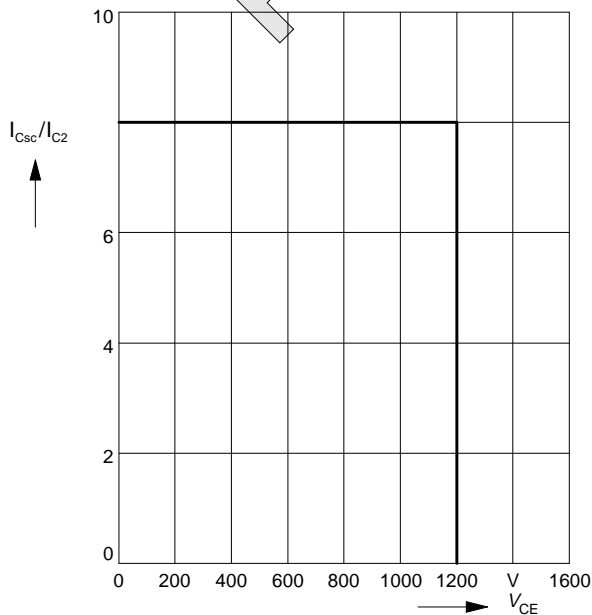
Short circuit safe operating area

$$I_{Csc} = f(V_{CE}), T_j = 150^\circ C$$

 parameter: $V_{GE} = \pm 15V, t_{sc} \leq 10\ \mu s, L < 25\ nH$

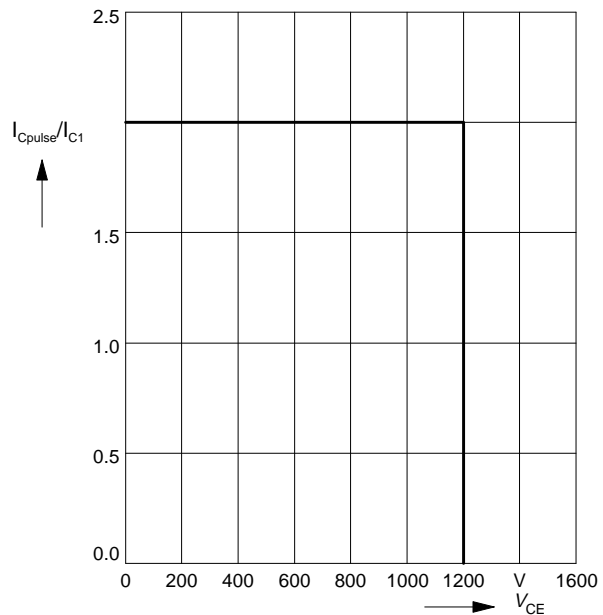
Reverse biased safe operating area

$$I_{Cpuls} = f(V_{CE}), T_j = 150^\circ C$$

 parameter: $V_{GE} = 15V$

EUROPE

Avenue J.F. Kennedy Bât B4 Parc Cadéra Nord

USA

405 S.W. Columbia Street

F-33700 Merignac - France

Bend, Oregon 97702-1035

Phone: (33) 5 57 92 15 15

Phone: (541) 382-8028

FAX: (33) 5 56 47 97 61

FAX: (541) 388-0364

Typ. output characteristics

$I_C = f(V_{CE})$

parameter: $t_p = 80 \mu s, T_j = 25 \text{ }^\circ\text{C}$

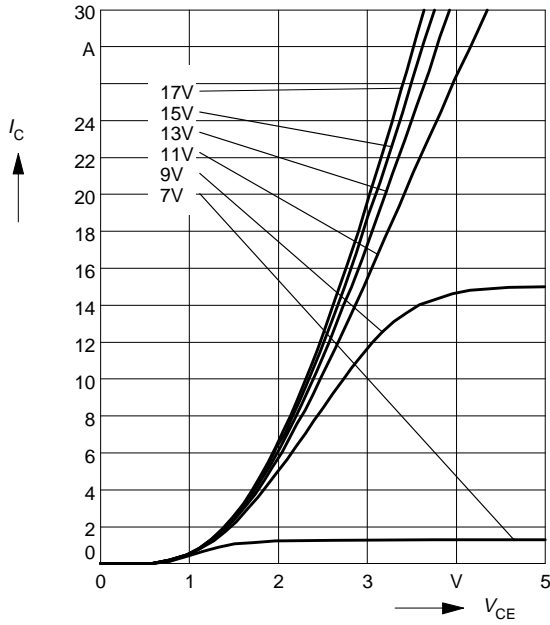

Typ. output characteristics

$I_C = f(V_{CE})$

parameter: $t_p = 80 \mu s, T_j = 125 \text{ }^\circ\text{C}$

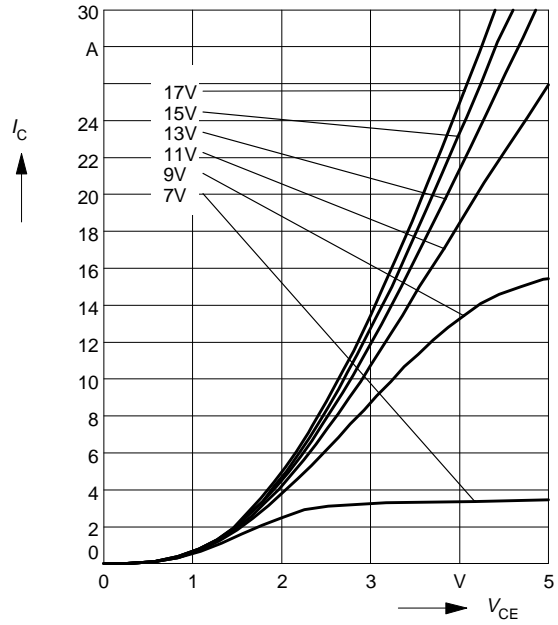

Typ. transfer characteristics

$I_C = f(V_{GE})$

parameter: $t_p = 80 \mu s, V_{CE} = 20 \text{ V}$

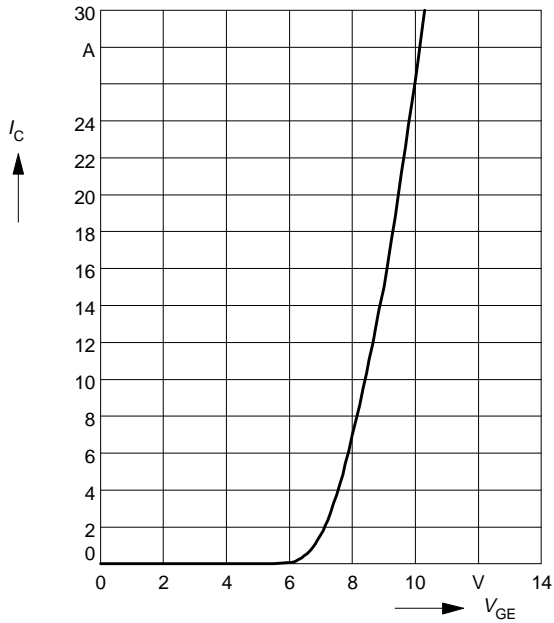

ULTRAFAST SOFT RECOVERY PARALLEL DIODE

MAXIMUM RATINGS (FRED)

All Ratings: $T_C = 25^\circ\text{C}$ unless otherwise specified.

Symbol	Characteristic / Test Conditions	APT20GF120BRD	UNIT
V_R	Maximum D.C. Reverse Voltage	1200	Volts
V_{RRM}	Maximum Peak Repetitive Reverse Voltage		
V_{RWM}	Maximum Working Peak Reverse Voltage		
$I_F(AV)$	Maximum Average Forward Current ($T_C = 85^\circ\text{C}$, Duty Cycle = 0.5)	30	Amps
$I_F(RMS)$	RMS Forward Current	70	
I_{FSM}	Non-Repetitive Forward Surge Current ($T_J = 45^\circ\text{C}$, 8.3ms)	210	

STATIC ELECTRICAL CHARACTERISTICS (FRED)

Symbol	Characteristic / Test Conditions	MIN	TYP	MAX	UNIT
V_F	Maximum Forward Voltage		2.0	$I_F = 30\text{A}$	2.5
				$I_F = 60\text{A}$	
				$I_F = 30\text{A}, T_J = 150^\circ\text{C}$	2.0
I_{RM}	Maximum Reverse Leakage Current			$V_R = V_R$ Rated	250
				$V_R = V_R$ Rated, $T_J = 125^\circ\text{C}$	500
L_S	Series Inductance (Lead to Lead 5mm from Base)		10		nH

DYNAMIC CHARACTERISTICS (FRED)

Symbol	Characteristic	MIN	TYP	MAX	UNIT
t_{rr1}	Reverse Recovery Time, $I_F = 1.0\text{A}$, $di_F/dt = -15\text{A}/\mu\text{s}$, $V_R = 30\text{V}$, $T_J = 25^\circ\text{C}$		70	85	ns
t_{rr2}	Reverse Recovery Time		70		
t_{rr3}	$I_F = 30\text{A}$, $di_F/dt = -240\text{A}/\mu\text{s}$, $V_R = 650\text{V}$		160		
t_{fr1}	Forward Recovery Time		255		Volts
t_{fr2}	$I_F = 30\text{A}$, $di_F/dt = 240\text{A}/\mu\text{s}$, $V_R = 650\text{V}$		255		
I_{RRM1}	Reverse Recovery Current		7	12	Amps
I_{RRM2}	$I_F = 30\text{A}$, $di_F/dt = -240\text{A}/\mu\text{s}$, $V_R = 650\text{V}$		12	20	
Q_{rr1}	Recovery Charge		660		nC
Q_{rr2}	$I_F = 30\text{A}$, $di_F/dt = -240\text{A}/\mu\text{s}$, $V_R = 650\text{V}$		1640		
V_{fr1}	Forward Recovery Voltage		15		Volts
V_{fr2}	$I_F = 30\text{A}$, $di_F/dt = 240\text{A}/\mu\text{s}$, $V_R = 650\text{V}$		20		
diM/dt	Rate of Fall of Recovery Current		245		A/ μs
	$I_F = 30\text{A}$, $di_F/dt = -240\text{A}/\mu\text{s}$, $V_R = 650\text{V}$		160		

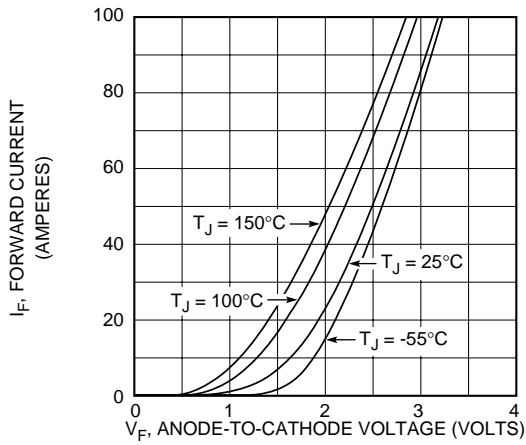

Figure 1, Forward Voltage Drop vs Forward Current

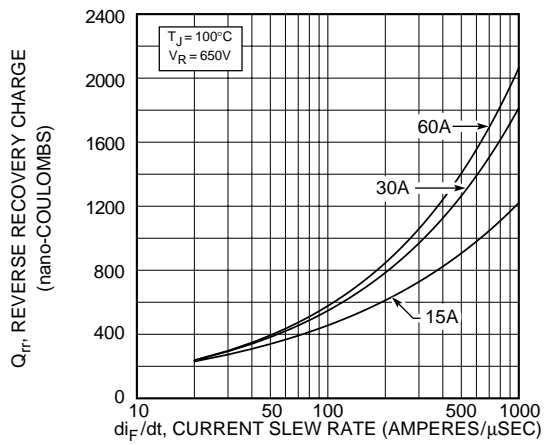

Figure 2, Reverse Recovery Charge vs Current Slew Rate

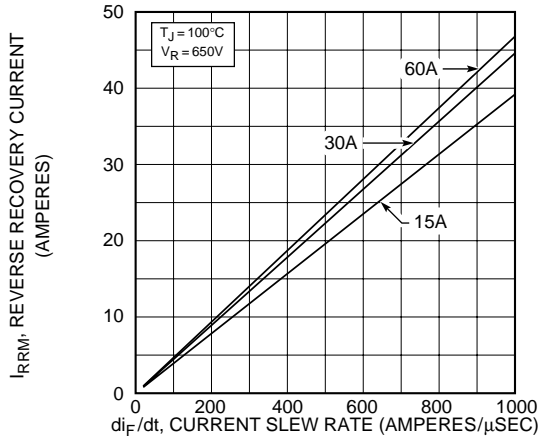

Figure 3, Reverse Recovery Current vs Current Slew Rate

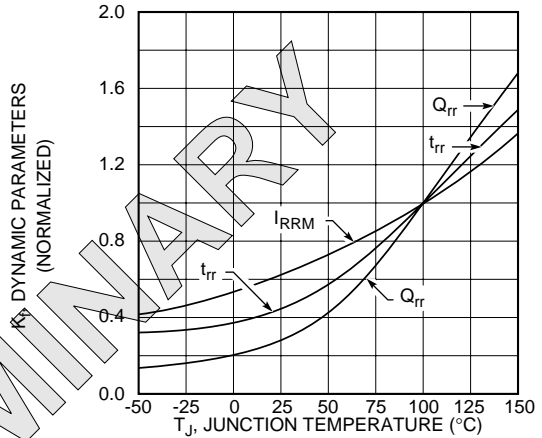

Figure 4, Dynamic Parameters vs Junction Temperature

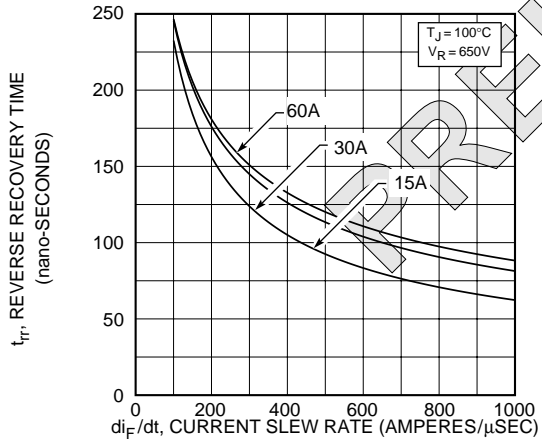

Figure 5, Reverse Recovery Time vs Current Slew Rate

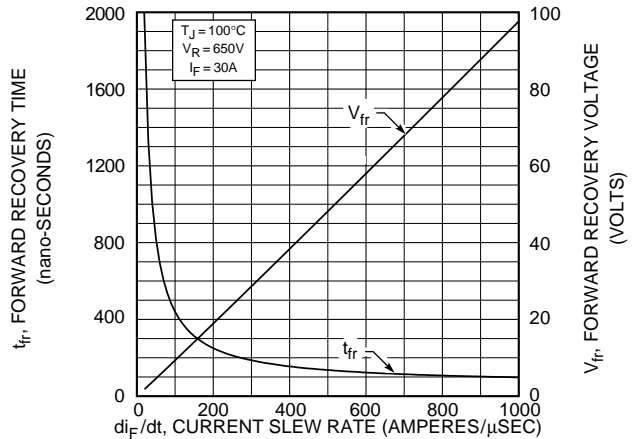

Figure 6, Forward Recovery Voltage/Time vs Current Slew Rate

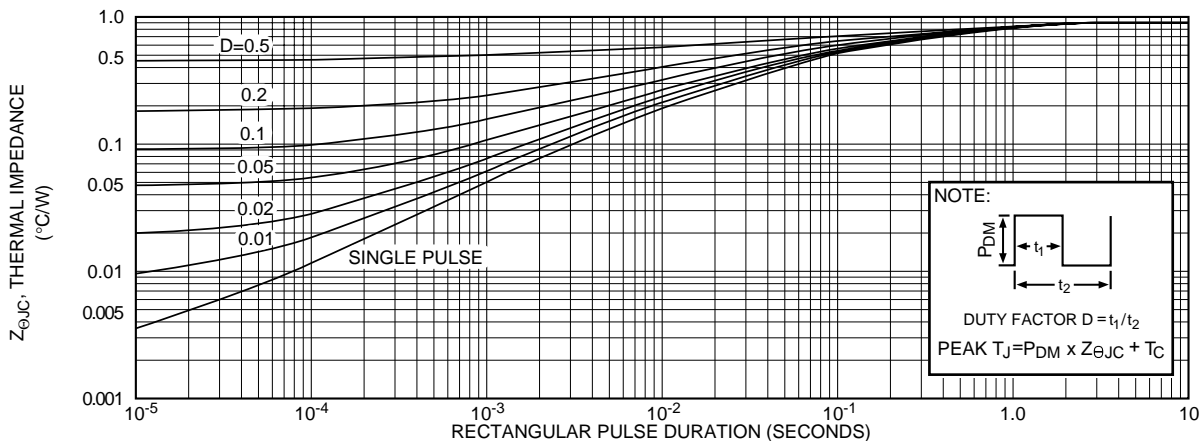

Figure 7, Maximum Effective Transient Thermal Impedance, Junction-To-Case vs Pulse Duration

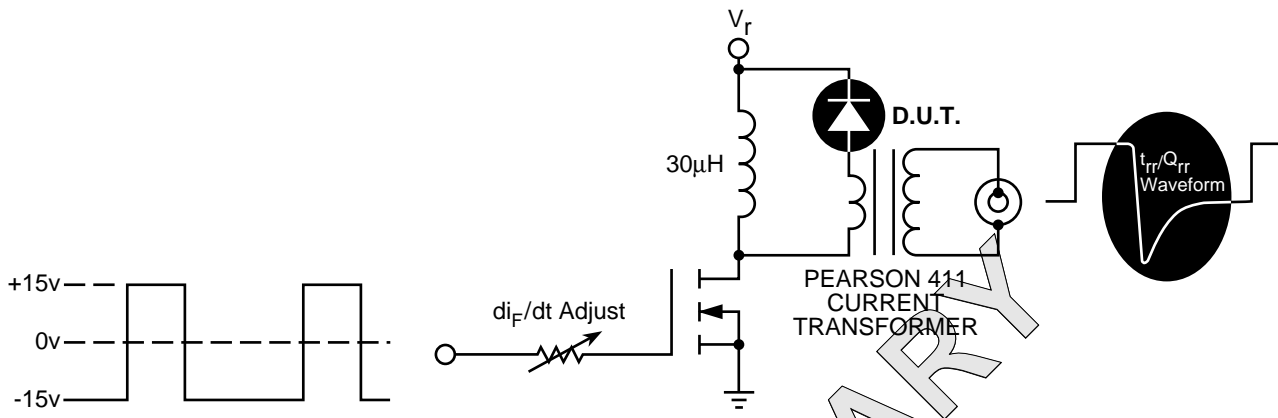

Figure 25, Diode Reverse Recovery Test Circuit and Waveforms

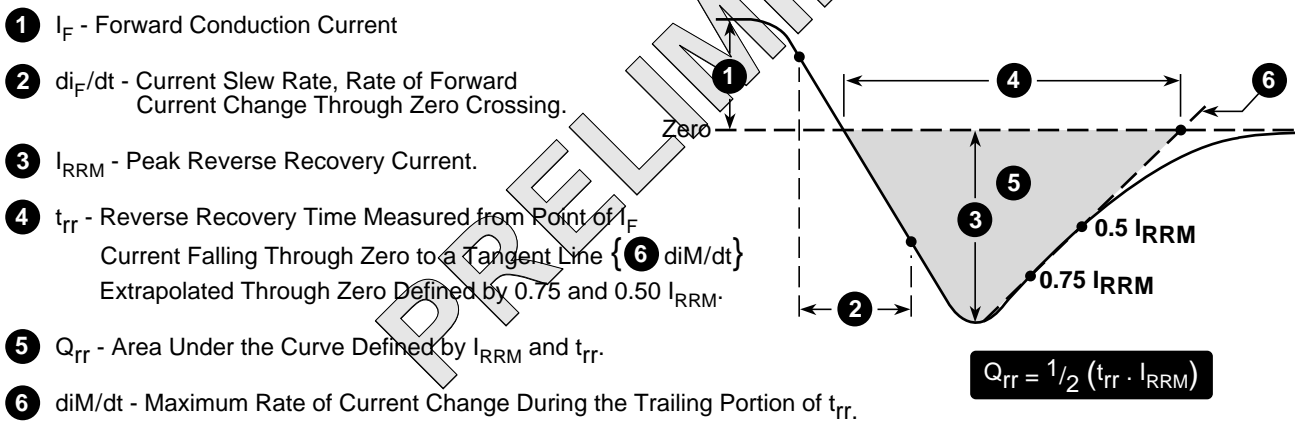
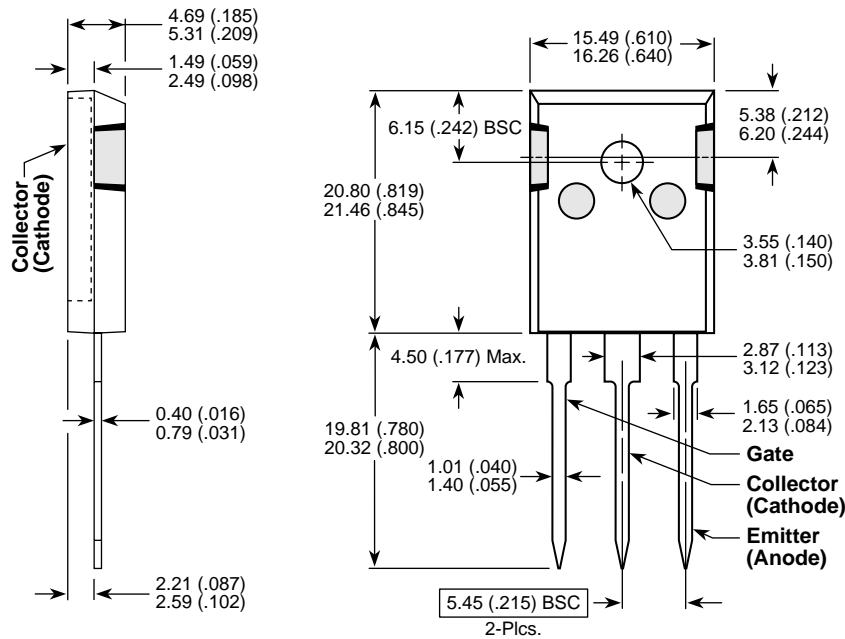

Figure 8, Diode Reverse Recovery Waveform and Definitions

TO-247 Package Outline



Dimensions in Millimeters and (Inches)