

## Zero Recovery Silicon Carbide Schottky Diode

**PRODUCT APPLICATIONS**

- Anti-Parallel Diode  
-Switchmode Power Supply  
-Inverters
- Power Factor Correction (PFC)

**PRODUCT FEATURES**

- Zero Recovery Times ( $t_{rr}$ )
- Popular TO-247 Package or surface mount D<sup>3</sup>PAK package
- Low Forward Voltage
- Low Leakage Current

**PRODUCT BENEFITS**

- Higher Reliability Systems
- Minimizes or eliminates snubber

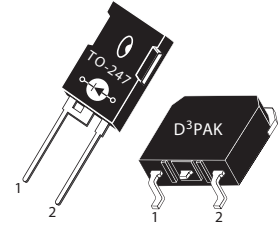

1 - Cathode  
2 - Anode  
Back of Case - Cathode

**MAXIMUM RATINGS**
 $T_C = 25^\circ\text{C}$  unless otherwise specified.

Symbol	Characteristic / Test Conditions	Ratings	Unit
$V_R$	Maximum D.C. Reverse Voltage	1200	Volts
$V_{RRM}$	Maximum Peak Repetitive Reverse Voltage		
$V_{RWM}$	Maximum Working Peak Reverse Voltage		
$I_F$	Maximum D.C. Forward current	$T_C = 25^\circ\text{C}$	68
		$T_C = 135^\circ\text{C}$	20
$I_{FRM}$	Repetitive Peak Forward Suge Current ( $T_J = 45^\circ\text{C}$ , $t_p = 10\text{ms}$ , Half Sine Wave)	100	Amps
$I_{FSM}$	Non-Repetitive Forward Surge Current ( $T_J = 25^\circ\text{C}$ , $t_p = 10\text{ms}$ , Half Sine)	220	
$P_{tot}$	Power Dissipation	$T_C = 25^\circ\text{C}$	208
		$T_C = 110^\circ\text{C}$	66
$T_J, T_{STG}$	Operating and Storage Junction Temperature Range	-55 to 150	$^\circ\text{C}$
$T_L$	Lead Temperature for 10 Seconds	300	

**STATIC ELECTRICAL CHARACTERISTICS**

Symbol	Characteristic / Test Conditions	Min	Typ	Max	Unit
$V_F$	Forward Voltage		$I_F = 20\text{A}$ , $T_J = 25^\circ\text{C}$	1.5	1.8
			$I_F = 20\text{A}$ , $T_J = 150^\circ\text{C}$	2.2	
$I_{RM}$	Maximum Reverse Leakage Current		$V_R = 1200\text{V}$ , $T_J = 25^\circ\text{C}$		400
			$V_R = 1200\text{V}$ , $T_J = 150^\circ\text{C}$		2000
$Q_C$	Total Capacitive Charge $V_R = 800\text{V}$ , $I_F = 20\text{A}$ , $di/dt = -100\text{A}/\mu\text{s}$ , $T_J = 25^\circ\text{C}$		66		nC
$C_T$	Junction Capacitance $V_R = 0\text{V}$ , $T_J = 25^\circ\text{C}$ , $f = 1\text{MHz}$		1135		pF
	Junction Capacitance $V_R = 200\text{V}$ , $T_J = 25^\circ\text{C}$ , $f = 1\text{MHz}$		160		
	Junction Capacitance $V_R = 400\text{V}$ , $T_J = 25^\circ\text{C}$ , $f = 1\text{MHz}$		100		

Symbol	Characteristic / Test Conditions	Min	Typ	Max	Unit
$R_{\theta JC}$	Junction-to-Case Thermal Resistance			0.6 °C/W	
$W_T$	Package Weight	0.22			oz
		5.9			g
Torque	Maximum Mounting Torque	10			lb-in
		1.1			N·m

Microsemi reserves the right to change, without notice, the specifications and information contained herein.

TYPICAL PERFORMANCE CURVES

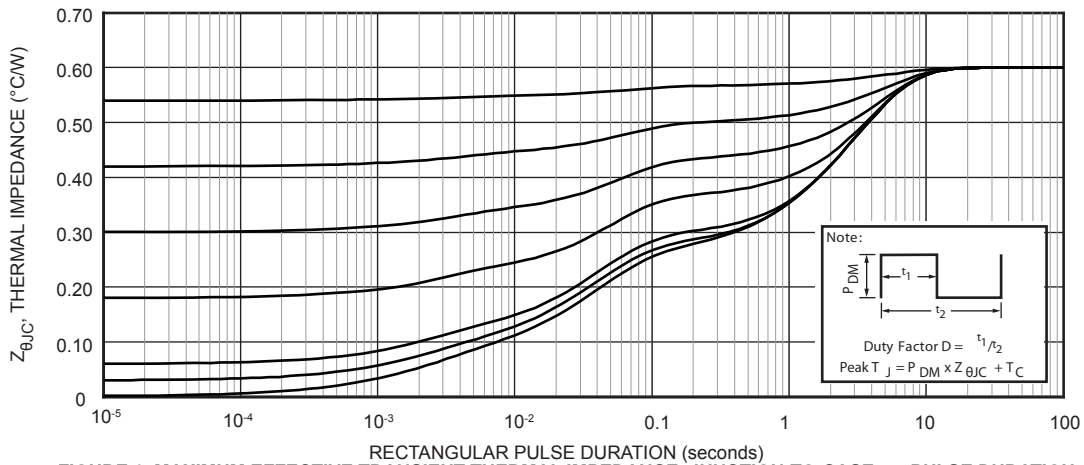

FIGURE 1. MAXIMUM EFFECTIVE TRANSIENT THERMAL IMPEDANCE, JUNCTION-TO-CASE vs. PULSE DURATION

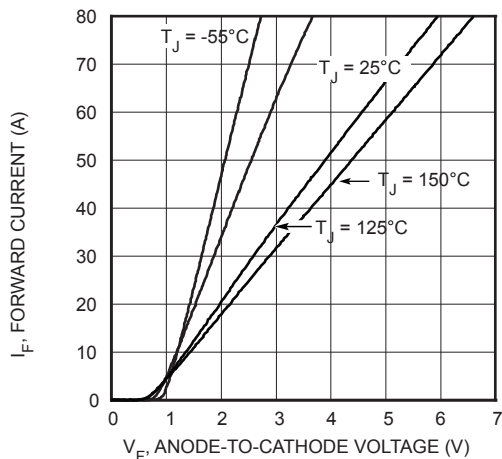

FIGURE 2, Forward Current vs. Forward Voltage

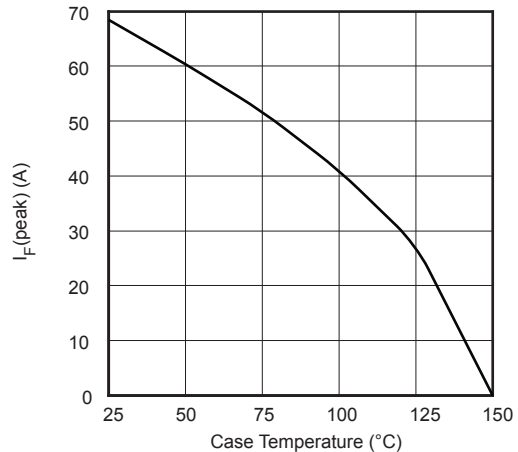

FIGURE 3, Maximum Forward Current vs. Case Temperature

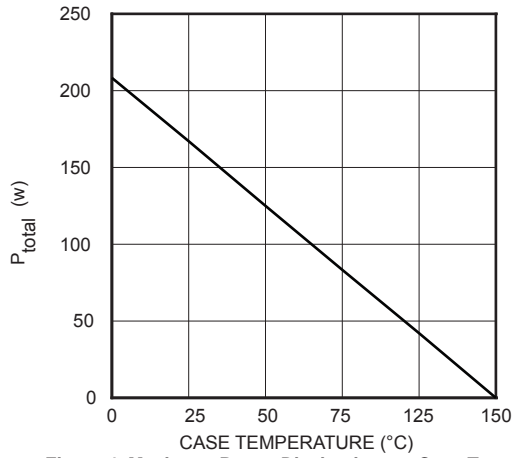

Figure 4. Maximum Power Dissipation vs. Case Temperature

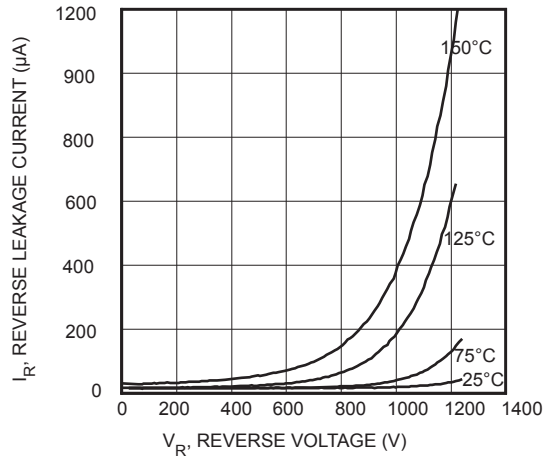

Figure 5. Reverse Leakage Currents vs. Reverse Voltage

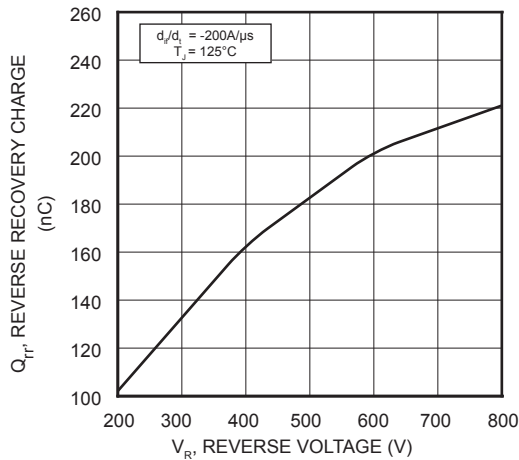

Figure 6. Reverse Recovery Charge vs.  $V_R$

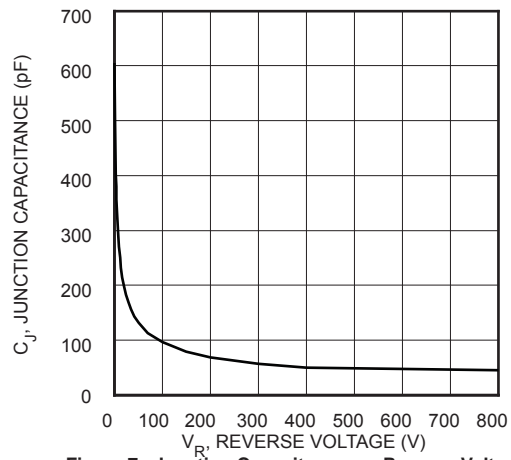
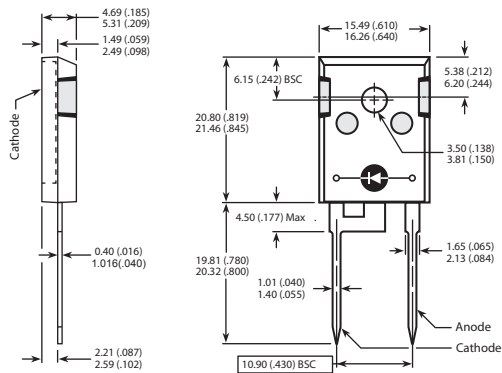

Figure 7. Junction Capacitance vs. Reverse Voltage

TO-247 Package Outline



Dimensions in Millimeters and (Inches)

D<sup>3</sup>PAK Package Outline

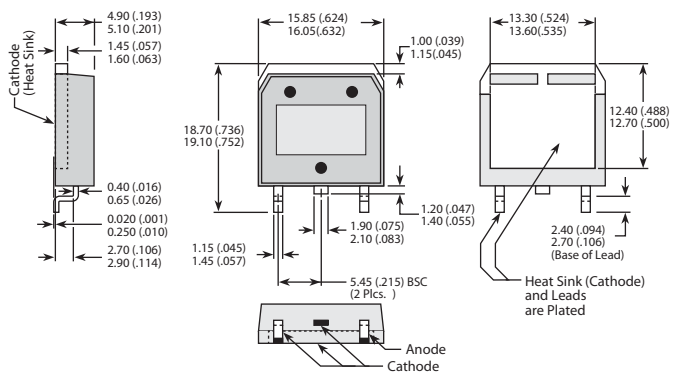

Dimensions in Millimeters and (Inches)

**Disclaimer:**

The information contained in the document (unless it is publicly available on the Web without access restrictions) is PROPRIETARY AND CONFIDENTIAL information of Microsemi and cannot be copied, published, uploaded, posted, transmitted, distributed or disclosed or used without the express duly signed written consent of Microsemi. If the recipient of this document has entered into a disclosure agreement with Microsemi, then the terms of such Agreement will also apply. This document and the information contained herein may not be modified, by any person other than authorized personnel of Microsemi. No license under any patent, copyright, trade secret or other intellectual property right is granted to or conferred upon you by disclosure or delivery of the information, either expressly, by implication, inducement, estoppels or otherwise. Any license under such intellectual property rights must be approved by Microsemi in writing signed by an officer of Microsemi.

Microsemi reserves the right to change the configuration, functionality and performance of its products at anytime without any notice. This product has been subject to limited testing and should not be used in conjunction with life-support or other mission-critical equipment or applications. Microsemi assumes no liability whatsoever, and Microsemi disclaims any express or implied warranty, relating to sale and/or use of Microsemi products including liability or warranties relating to fitness for a particular purpose, merchantability, or infringement of any patent, copyright or other intellectual property right. Any performance specifications believed to be reliable but are not verified and customer or user must conduct and complete all performance and other testing of this product as well as any user or customers final application. User or customer shall not rely on any data and performance specifications or parameters provided by Microsemi. It is the customer's and user's responsibility to independently determine suitability of any Microsemi product and to test and verify the same. The information contained herein is provided "AS IS, WHERE IS" and with all faults, and the entire risk associated with such information is entirely with the User. Microsemi specifically disclaims any liability of any kind including for consequential, incidental and punitive damages as well as lost profit. The product is subject to other terms and conditions which can be located on the web at <http://www.microsemi.com/legal/tnc.asp>