

**ISOTOP® Boost chopper  
Super Junction  
MOSFET Power Module**

**$V_{DSS} = 600V$   
 $R_{DSon} = 70m\Omega$  max @  $T_j = 25^\circ C$   
 $I_D = 40A$  @  $T_c = 25^\circ C$**

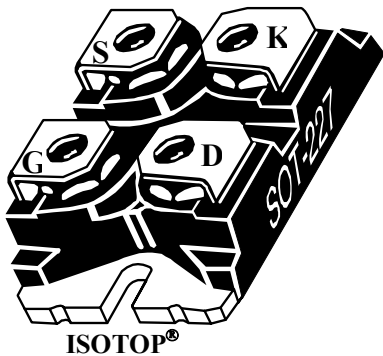
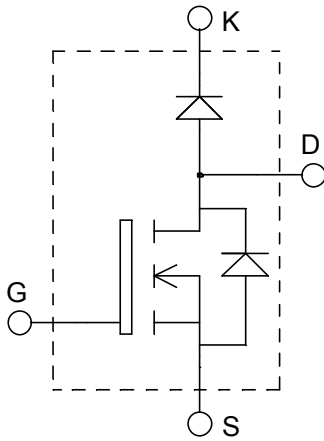

**Application**

- AC and DC motor control
- Switched Mode Power Supplies
- Power Factor Correction
- Brake switch

**Features**

- **COOLMOS** Power Semiconductors
  - Ultra low  $R_{DSon}$
  - Low Miller capacitance
  - Ultra low gate charge
  - Avalanche energy rated
- ISOTOP® Package (SOT-227)
- Very low stray inductance
- High level of integration

**Benefits**

- Outstanding performance at high frequency operation
- Stable temperature behavior
- Very rugged
- Direct mounting to heatsink (isolated package)
- Low junction to case thermal resistance
- Easy paralleling due to positive TC of VCEsat

**Absolute maximum ratings**

Symbol	Parameter	Max ratings	Unit
$V_{DSS}$	Drain - Source Breakdown Voltage	600	V
$I_D$	Continuous Drain Current	$T_c = 25^\circ C$	40
		$T_c = 80^\circ C$	30
$I_{DM}$	Pulsed Drain current	120	A
$V_{GS}$	Gate - Source Voltage	$\pm 20$	V
$R_{DSon}$	Drain - Source ON Resistance	70	$m\Omega$
$P_D$	Maximum Power Dissipation	$T_c = 25^\circ C$	290
$I_{AR}$	Avalanche current (repetitive and non repetitive)	20	A
$E_{AR}$	Repetitive Avalanche Energy	1	mJ
$E_{AS}$	Single Pulse Avalanche Energy	1800	
$I_{FAV}$	Maximum Average Forward Current	Duty cycle=0.5	A
$I_{FRMS}$	RMS Forward Current (Square wave, 50% duty)	$T_c = 80^\circ C$	
			39

**CAUTION:** These Devices are sensitive to Electrostatic Discharge. Proper Handling Procedures Should Be Followed.

All ratings @  $T_j = 25^\circ\text{C}$  unless otherwise specified

## Electrical Characteristics

Symbol	Characteristic	Test Conditions	Min	Typ	Max	Unit
$BV_{DSS}$	Drain - Source Breakdown Voltage	$V_{GS} = 0V, I_D = 250\mu A$	600			V
$I_{DSS}$	Zero Gate Voltage Drain Current	$V_{GS} = 0V, V_{DS} = 600V, T_j = 25^\circ\text{C}$			25	$\mu A$
		$V_{GS} = 0V, V_{DS} = 600V, T_j = 125^\circ\text{C}$			250	
$R_{DS(on)}$	Drain - Source on Resistance	$V_{GS} = 10V, I_D = 20A$			70	$m\Omega$
$V_{GS(th)}$	Gate Threshold Voltage	$V_{GS} = V_{DS}, I_D = 1mA$	2.1	3	3.9	V
$I_{GSS}$	Gate - Source Leakage Current	$V_{GS} = \pm 20V, V_{DS} = 0V$			$\pm 100$	nA

## Dynamic Characteristics

Symbol	Characteristic	Test Conditions	Min	Typ	Max	Unit
$C_{iss}$	Input Capacitance	$V_{GS} = 0V$ $V_{DS} = 25V$ $f = 1MHz$		7015		$\mu F$
$C_{oss}$	Output Capacitance			2565		
$C_{rss}$	Reverse Transfer Capacitance			212		
$Q_g$	Total gate Charge	$V_{GS} = 10V$ $V_{Bus} = 300V$ $I_D = 40A$		259		nC
$Q_{gs}$	Gate - Source Charge			29		
$Q_{gd}$	Gate - Drain Charge			111		
$T_{d(on)}$	Turn-on Delay Time	<b>Resistive Switching</b> $V_{GS} = 15V$ $V_{Bus} = 380V$ $I_D = 40A$ $R_G = 1.8\Omega$		20		ns
$T_r$	Rise Time			30		
$T_{d(off)}$	Turn-off Delay Time			115		
$T_f$	Fall Time			10		
$E_{on}$	Turn-on Switching Energy ❶	<b>Inductive switching @ 25°C</b> $V_{GS} = 15V, V_{Bus} = 400V$ $I_D = 40A, R_G = 5\Omega$		670		$\mu J$
$E_{off}$	Turn-off Switching Energy ❷			980		
$E_{on}$	Turn-on Switching Energy ❶	<b>Inductive switching @ 125°C</b> $V_{GS} = 15V, V_{Bus} = 400V$ $I_D = 40A, R_G = 5\Omega$		1100		$\mu J$
$E_{off}$	Turn-off Switching Energy ❷			1206		

❶  $E_{on}$  includes diode reverse recovery

❷ In accordance with JEDEC standard JESD24-1.

**Diode ratings and characteristics**

Symbol	Characteristic	Test Conditions	Min	Typ	Max	Unit	
V <sub>F</sub>	Diode Forward Voltage	I <sub>F</sub> = 30A		1.6	1.8	V	
		I <sub>F</sub> = 60A		1.9			
		I <sub>F</sub> = 30A	T <sub>j</sub> = 125°C		1.4		
I <sub>RM</sub>	Maximum Reverse Leakage Current	V <sub>R</sub> = 600V			250	µA	
		V <sub>R</sub> = 600V	T <sub>j</sub> = 125°C		500		
C <sub>T</sub>	Junction Capacitance	V <sub>R</sub> = 200V		44		pF	
t <sub>rr</sub>	Reverse Recovery Time	I <sub>F</sub> =1A, V <sub>R</sub> =30V di/dt =100A/µs	T <sub>j</sub> = 25°C	23		ns	
	Reverse Recovery Time	I <sub>F</sub> = 30A V <sub>R</sub> = 400V di/dt =200A/µs	T <sub>j</sub> = 25°C	85			
I <sub>RRM</sub>	Maximum Reverse Recovery Current		T <sub>j</sub> = 125°C	160			
			T <sub>j</sub> = 25°C	4			
Q <sub>rr</sub>	Reverse Recovery Charge		I <sub>F</sub> = 30A V <sub>R</sub> = 400V di/dt =200A/µs	T <sub>j</sub> = 125°C	8		A
		T <sub>j</sub> = 25°C		130			
t <sub>rr</sub>	Reverse Recovery Time	I <sub>F</sub> = 30A V <sub>R</sub> = 400V di/dt =1000A/µs		T <sub>j</sub> = 25°C	70		ns
				T <sub>j</sub> = 125°C	1300		
Q <sub>rr</sub>	Reverse Recovery Charge	I <sub>F</sub> = 30A V <sub>R</sub> = 400V di/dt =1000A/µs	T <sub>j</sub> = 125°C	30		nC	
I <sub>RRM</sub>	Maximum Reverse Recovery Current					A	

**Thermal and package characteristics**

Symbol	Characteristic	Min	Typ	Max	Unit
R <sub>thJC</sub>	Junction to Case	CoolMos		0.43	°C/W
		Diode		1.21	
R <sub>thJA</sub>	Junction to Ambient (IGBT & Diode)			20	
V <sub>ISOL</sub>	RMS Isolation Voltage, any terminal to case t =1 min, I isol <1mA, 50/60Hz	2500			V
T <sub>J</sub> , T <sub>STG</sub>	Storage Temperature Range	-55		150	°C
T <sub>L</sub>	Max Lead Temp for Soldering: 0.063" from case for 10 sec			300	
Torque	Mounting torque (Mounting = 8-32 or 4mm Machine and terminals = 4mm Machine)			1.5	N.m
Wt	Package Weight		29.2		g

**Typical CoolMOS Performance Curve**

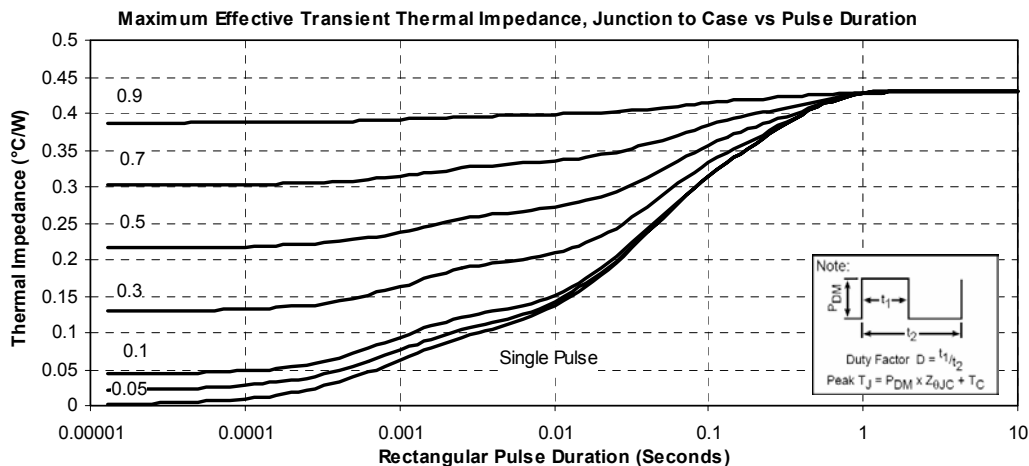

Fig 1, Maximum Effective transient thermal Impedance, Junction to case vs Pulse Duration

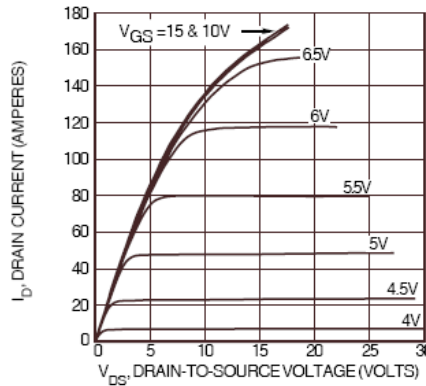

FIGURE 3, LOW VOLTAGE OUTPUT CHARACTERISTICS

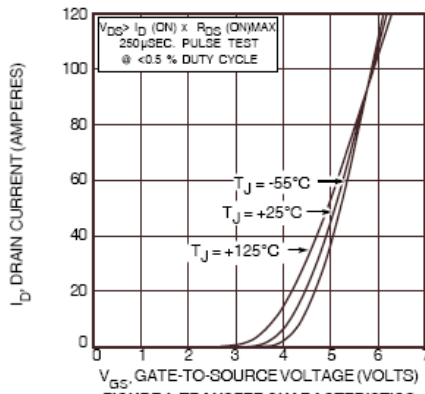

FIGURE 4, TRANSFER CHARACTERISTICS

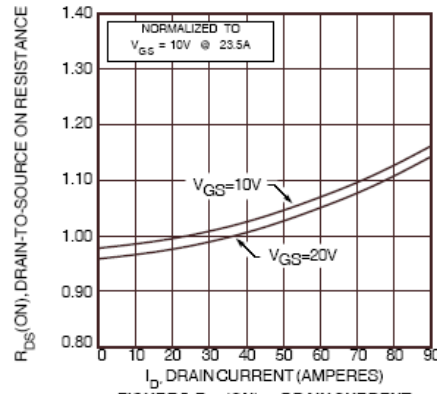

FIGURE 5,  $R_{DS(ON)}$  vs DRAIN CURRENT

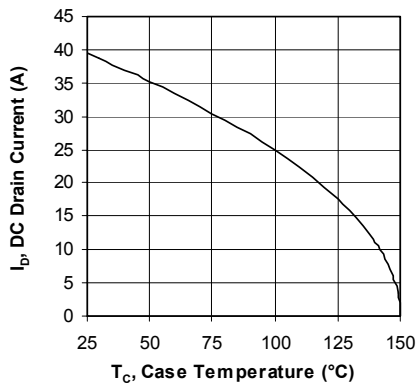

Figure 6, DC Drain Current vs Case Temperature

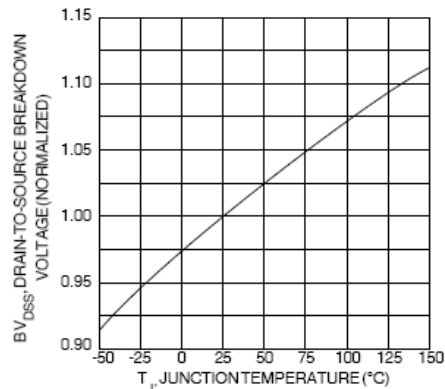

FIGURE 7, BREAKDOWN VOLTAGE vs TEMPERATURE

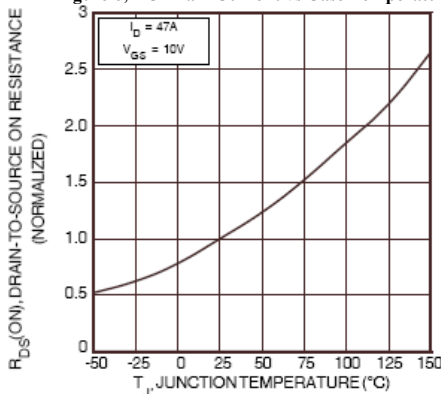

FIGURE 8, ON-RESISTANCE vs. TEMPERATURE

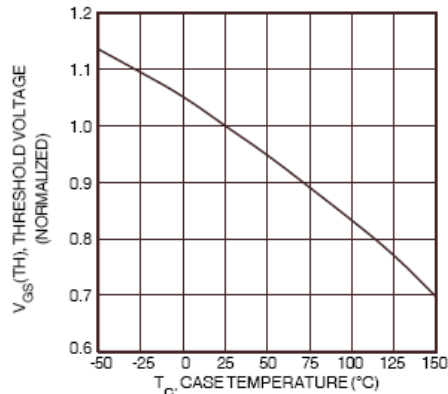

FIGURE 9, THRESHOLD VOLTAGE vs TEMPERATURE

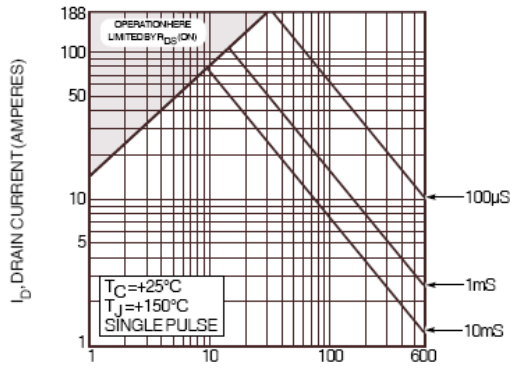

FIGURE 10, MAXIMUM SAFE OPERATING AREA

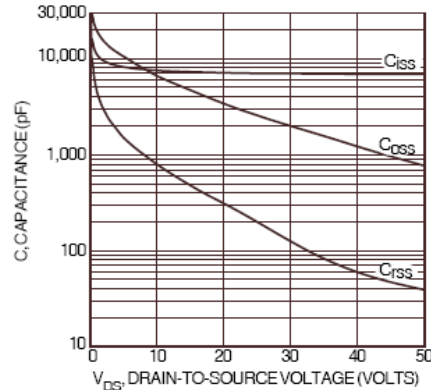

FIGURE 11, CAPACITANCE vs DRAIN-TO-SOURCE VOLTAGE

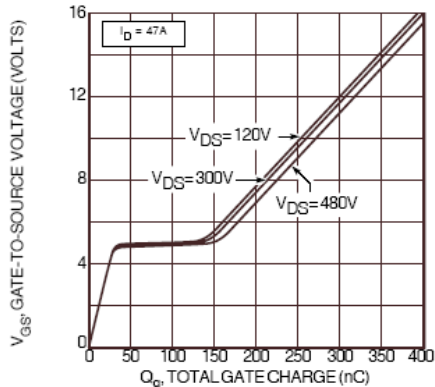

FIGURE 12, GATE CHARGES vs GATE-TO-SOURCE VOLTAGE

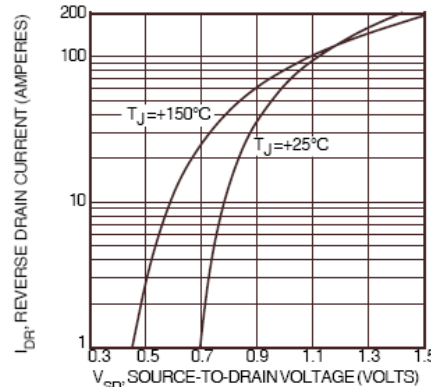

FIGURE 13, SOURCE-DRAIN DIODE FORWARD VOLTAGE

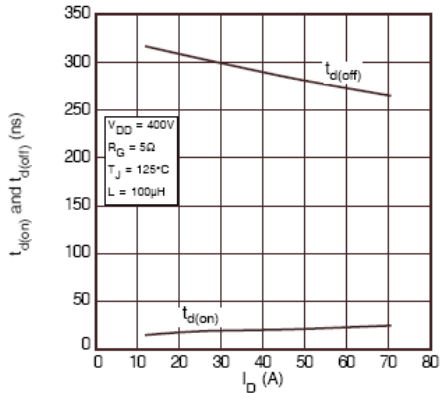

FIGURE 14, DELAY TIMES vs CURRENT

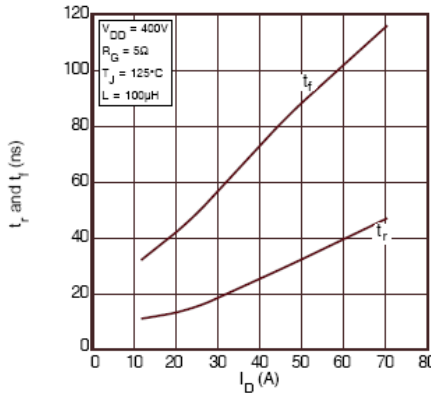

FIGURE 15, RISE AND FALL TIMES vs CURRENT

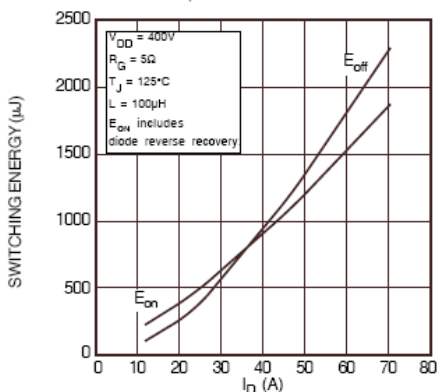

FIGURE 16, SWITCHING ENERGY vs CURRENT

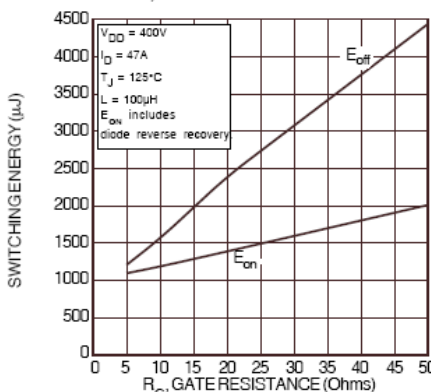

FIGURE 17, SWITCHING ENERGY vs. GATE RESISTANCE

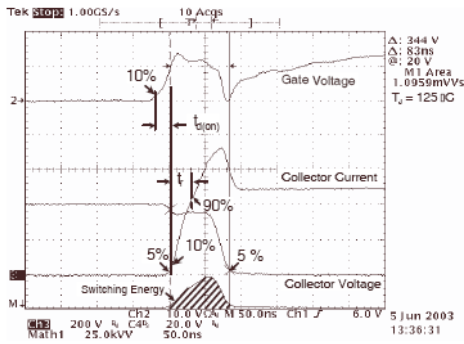

Figure 18, Turn-on Switching Waveforms and Definitions

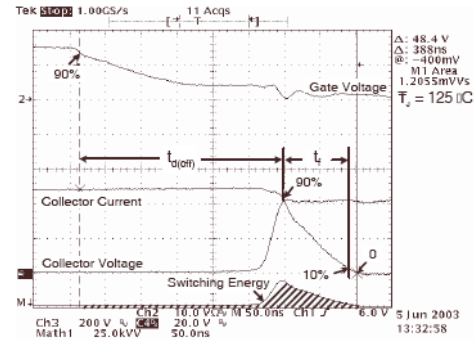

Figure 19, Turn-off Switching Waveforms and Definitions

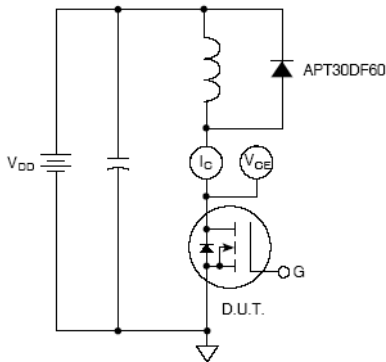

Figure 20, Inductive Switching Test Circuit

**Typical Diode Performance Curve**

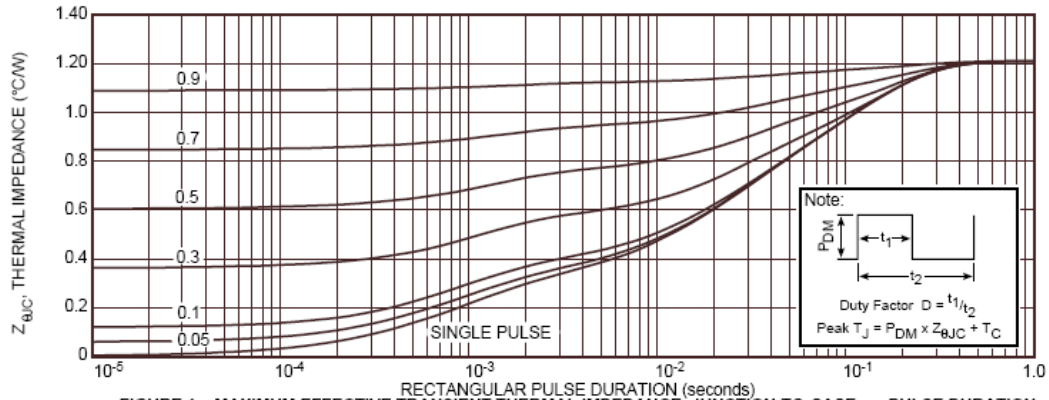

FIGURE 1a. MAXIMUM EFFECTIVE TRANSIENT THERMAL IMPEDANCE, JUNCTION-TO-CASE vs. PULSE DURATION

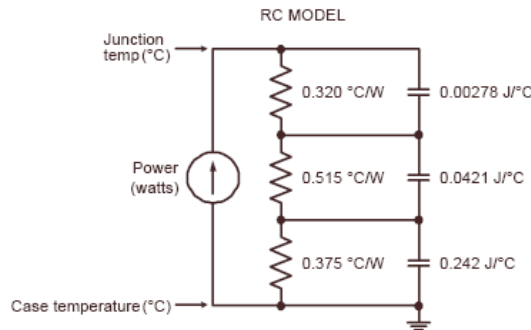

FIGURE 1b, TRANSIENT THERMAL IMPEDANCE MODEL

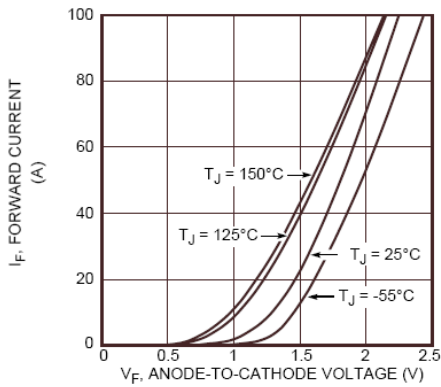

Figure 2. Forward Current vs. Forward Voltage

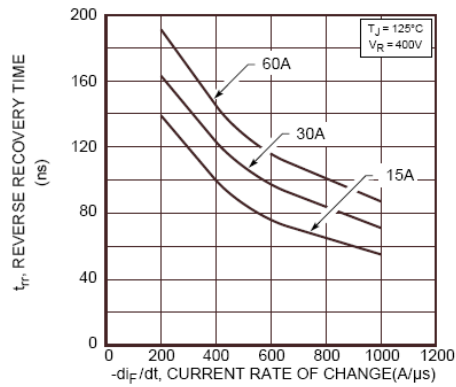

Figure 3. Reverse Recovery Time vs. Current Rate of Change

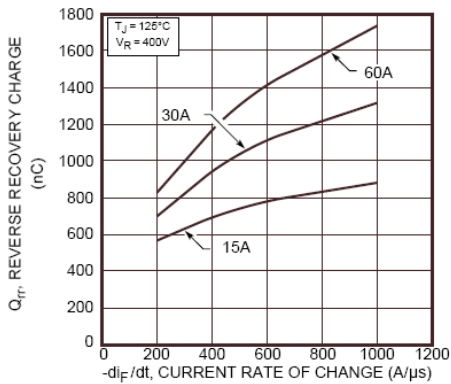

Figure 4. Reverse Recovery Charge vs. Current Rate of Change

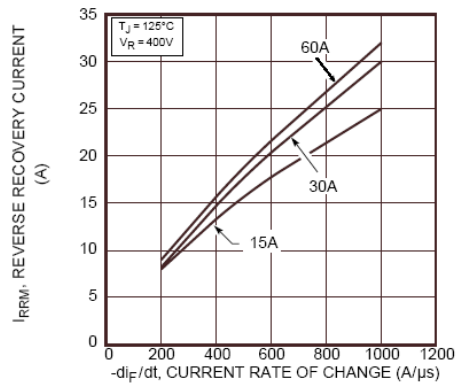

Figure 5. Reverse Recovery Current vs. Current Rate of Change

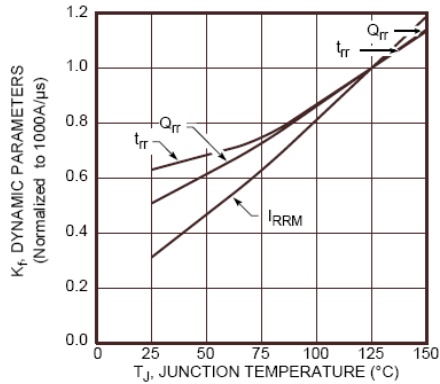

Figure 6. Dynamic Parameters vs. Junction Temperature

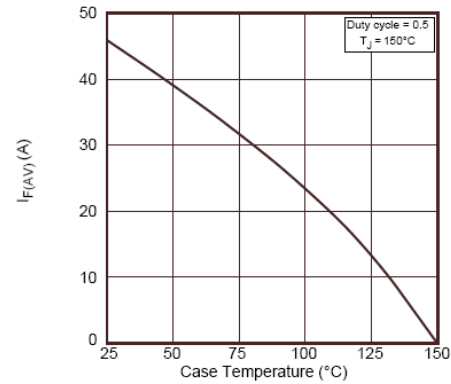

Figure 7. Maximum Average Forward Current vs. Case Temperature

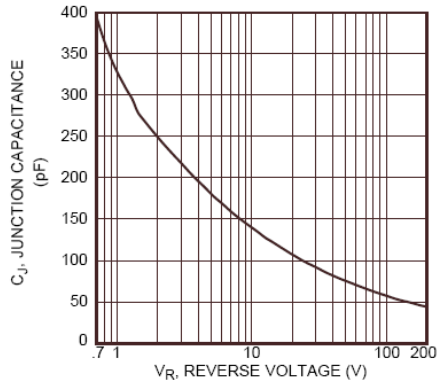

Figure 8. Junction Capacitance vs. Reverse Voltage



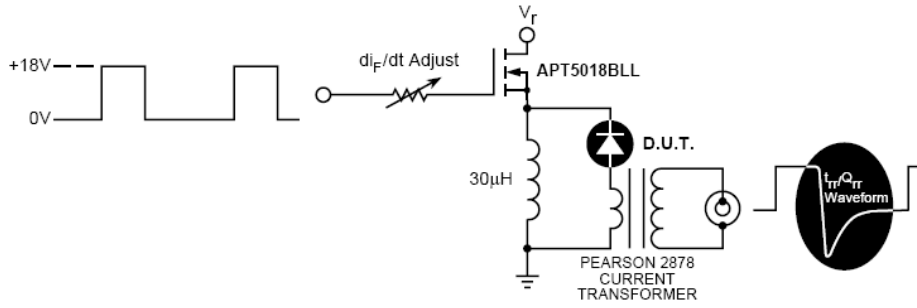

Figure 9. Diode Test Circuit

- ❶  $I_F$  - Forward Conduction Current
- ❷  $di_F/dt$  - Rate of Diode Current Change Through Zero Crossing.
- ❸  $I_{RRM}$  - Maximum Reverse Recovery Current.
- ❹  $t_{rr}$  - Reverse Recovery Time, measured from zero crossing where diode current goes from positive to negative, to the point at which the straight line through  $I_{RRM}$  and  $0.25 \cdot I_{RRM}$  passes through zero.
- ❺  $Q_{rr}$  - Area Under the Curve Defined by  $I_{RRM}$  and  $t_{rr}$ .

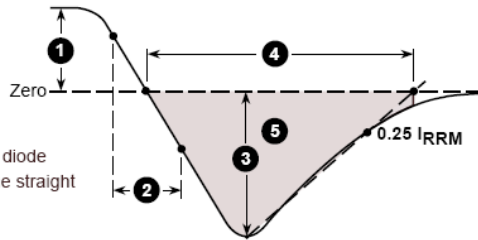
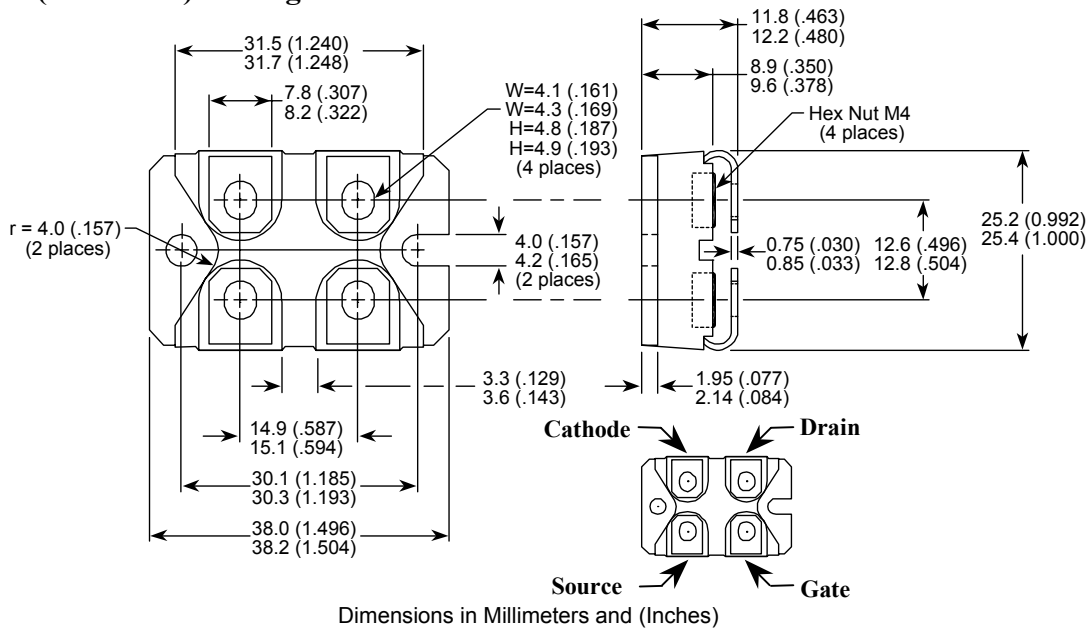

Figure 10. Diode Reverse Recovery Waveform and Definitions

**SOT-227 (ISOTOP®) Package Outline**



ISOTOP® is a Registered Trademark of SGS Thomson

APT reserves the right to change, without notice, the specifications and information contained herein

APT's products are covered by one or more of U.S. patents 4,895,810 5,045,903 5,089,434 5,182,234 5,019,522 5,262,336 6,503,786 5,256,583 4,748,103 5,283,202 5,231,474 5,434,095 5,528,058 and foreign patents. U.S. and Foreign patents pending. All Rights Reserved.