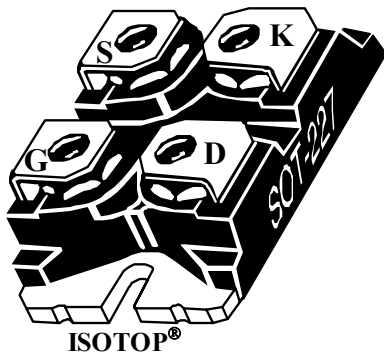
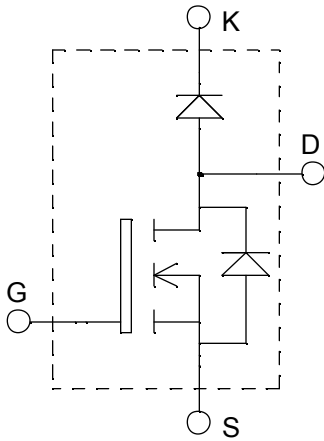

**ISOTOP<sup>®</sup> Boost chopper  
MOSFET Power Module**

$V_{DSS} = 500V$   
 $R_{DSon} = 100m\Omega \text{ max @ } T_j = 25^\circ C$   
 $I_D = 41A \text{ @ } T_c = 25^\circ C$

**Application**

- AC and DC motor control
- Switched Mode Power Supplies
- Power Factor Correction
- Brake switch

**Features**

- Power MOS 7<sup>®</sup> MOSFETs
  - Low  $R_{DSon}$
  - Low input and Miller capacitance
  - Low gate charge
  - Fast intrinsic reverse diode
  - Avalanche energy rated
  - Very rugged
- ISOTOP<sup>®</sup> Package (SOT-227)
- Very low stray inductance
- High level of integration

**Benefits**

- Outstanding performance at high frequency operation
- Direct mounting to heatsink (isolated package)
- Low junction to case thermal resistance
- Very rugged
- Low profile
- RoHS Compliant

**Absolute maximum ratings**

Symbol	Parameter	Max ratings	Unit
$V_{DSS}$	Drain - Source Breakdown Voltage	500	V
$I_D$	Continuous Drain Current	$T_c = 25^\circ C$	41
		$T_c = 80^\circ C$	30
$I_{DM}$	Pulsed Drain current	164	A
$V_{GS}$	Gate - Source Voltage	$\pm 30$	V
$R_{DSon}$	Drain - Source ON Resistance	100	$m\Omega$
$P_D$	Maximum Power Dissipation	$T_c = 25^\circ C$	378
$I_{AR}$	Avalanche current (repetitive and non repetitive)	41	A
$E_{AR}$	Repetitive Avalanche Energy	50	mJ
$E_{AS}$	Single Pulse Avalanche Energy	1600	
$I_{F_{AV}}$	Maximum Average Forward Current	Duty cycle=0.5	A
$I_{F_{RMS}}$	RMS Forward Current (Square wave, 50% duty)	$T_c = 80^\circ C$	

**CAUTION:** These Devices are sensitive to Electrostatic Discharge. Proper Handling Procedures Should Be Followed.

All ratings @  $T_j = 25^\circ\text{C}$  unless otherwise specified

**Electrical Characteristics**

Symbol	Characteristic	Test Conditions	Min	Typ	Max	Unit
$I_{DSS}$	Zero Gate Voltage Drain Current	$V_{GS} = 0\text{V}, V_{DS} = 500\text{V}$			100	$\mu\text{A}$
		$V_{GS} = 0\text{V}, V_{DS} = 400\text{V}$			500	
$R_{DS(on)}$	Drain – Source on Resistance	$V_{GS} = 10\text{V}, I_D = 23\text{A}$			100	$\text{m}\Omega$
$V_{GS(th)}$	Gate Threshold Voltage	$V_{GS} = V_{DS}, I_D = 2.5\text{mA}$	3		5	V
$I_{GSS}$	Gate – Source Leakage Current	$V_{GS} = \pm 20\text{V}, V_{DS} = 0\text{V}$			$\pm 100$	$\text{nA}$

**Dynamic Characteristics**

Symbol	Characteristic	Test Conditions	Min	Typ	Max	Unit
$C_{iss}$	Input Capacitance	$V_{GS} = 0\text{V}$		4360		$\text{pF}$
$C_{oss}$	Output Capacitance	$V_{DS} = 25\text{V}$		894		
$C_{rss}$	Reverse Transfer Capacitance	$f = 1\text{MHz}$		60		
$Q_g$	Total gate Charge	$V_{GS} = 10\text{V}$		96		$\text{nC}$
$Q_{gs}$	Gate – Source Charge	$V_{Bus} = 250\text{V}$		24		
$Q_{gd}$	Gate – Drain Charge	$I_D = 41\text{A} @ T_j = 25^\circ\text{C}$		49		
$T_{d(on)}$	Turn-on Delay Time	<b>Resistive switching @ <math>25^\circ\text{C}</math></b> $V_{GS} = 15\text{V}$ $V_{Bus} = 250\text{V}$ $I_D = 41\text{A} @ T_j = 25^\circ\text{C}$ $R_G = 0.6\Omega$		11		$\text{ns}$
$T_r$	Rise Time			15		
$T_{d(off)}$	Turn-off Delay Time			25		
$T_f$	Fall Time			3		
$E_{on}$	Turn-on Switching Energy	<b>Inductive Switching @ <math>25^\circ\text{C}</math></b> $V_{bus} = 330\text{V}, V_{GS} = 15\text{V}$ $I_D = 46\text{A}, R_G = 5\Omega$		543		$\mu\text{J}$
$E_{off}$	Turn-off Switching Energy			509		
$E_{on}$	Turn-on Switching Energy	<b>Inductive Switching @ <math>125^\circ\text{C}</math></b> $V_{bus} = 330\text{V}, V_{GS} = 15\text{V}$ $I_D = 46\text{A}, R_G = 5\Omega$		843		$\mu\text{J}$
$E_{off}$	Turn-off Switching Energy			593		

**Chopper diode ratings and characteristics**

Symbol	Characteristic	Test Conditions	Min	Typ	Max	Unit
$V_F$	Diode Forward Voltage	$I_F = 30\text{A}$		1.6	1.8	V
		$I_F = 60\text{A}$		1.9		
		$I_F = 30\text{A}$	$T_j = 125^\circ\text{C}$		1.4	
$I_{RM}$	Maximum Reverse Leakage Current	$V_R = 600\text{V}$	$T_j = 25^\circ\text{C}$		250	$\mu\text{A}$
		$V_R = 600\text{V}$	$T_j = 125^\circ\text{C}$		500	
$C_T$	Junction Capacitance	$V_R = 200\text{V}$		44		$\text{pF}$
$t_{rr}$	Reverse Recovery Time	$I_F = 1\text{A}, V_R = 30\text{V}$ $di/dt = 100\text{A}/\mu\text{s}$	$T_j = 25^\circ\text{C}$		23	$\text{ns}$
			$T_j = 25^\circ\text{C}$		85	
			$T_j = 125^\circ\text{C}$		160	
$I_{RRM}$	Maximum Reverse Recovery Current	$I_F = 30\text{A}$ $V_R = 400\text{V}$ $di/dt = 200\text{A}/\mu\text{s}$	$T_j = 25^\circ\text{C}$		4	A
			$T_j = 125^\circ\text{C}$		8	
			$T_j = 25^\circ\text{C}$		130	
$Q_{rr}$	Reverse Recovery Charge		$T_j = 25^\circ\text{C}$		130	$\text{nC}$
			$T_j = 125^\circ\text{C}$		700	
$t_{rr}$	Reverse Recovery Time	$I_F = 30\text{A}$	$T_j = 125^\circ\text{C}$		70	$\text{ns}$
$Q_{rr}$	Reverse Recovery Charge	$V_R = 400\text{V}$			1300	$\text{nC}$
$I_{RRM}$	Maximum Reverse Recovery Current	$di/dt = 1000\text{A}/\mu\text{s}$			30	A

**Thermal and package characteristics**
*Symbol Characteristic*

		<i>Min</i>	<i>Typ</i>	<i>Max</i>	<i>Unit</i>
$R_{thJC}$	Junction to Case Thermal Resistance	MOSFET		0.33	°C/W
		Diode		1.21	
$R_{thJA}$	Junction to Ambient (IGBT & Diode)			20	
$V_{ISOL}$	RMS Isolation Voltage, any terminal to case $t = 1$ min, $I_{isol} < 1$ mA, 50/60Hz	2500			V
$T_J, T_{STG}$	Storage Temperature Range	-55		150	°C
$T_L$	Max Lead Temp for Soldering: 0.063" from case for 10 sec			300	
Torque	Mounting torque (Mounting = 8-32 or 4mm Machine and terminals = 4mm Machine)			1.5	N.m
Wt	Package Weight		29.2		g

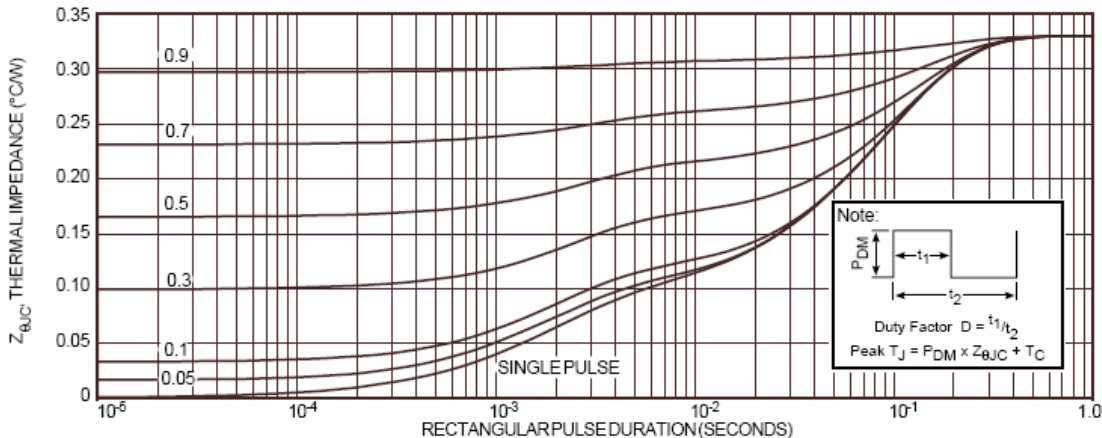
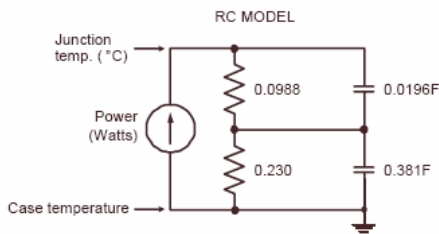
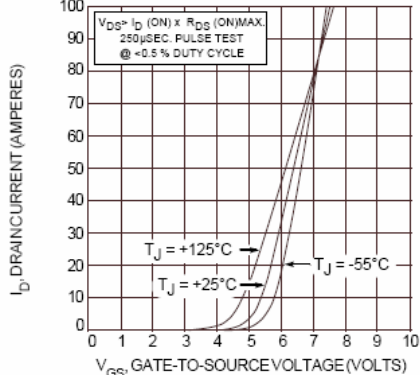
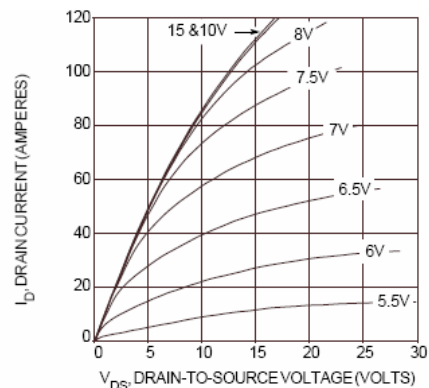
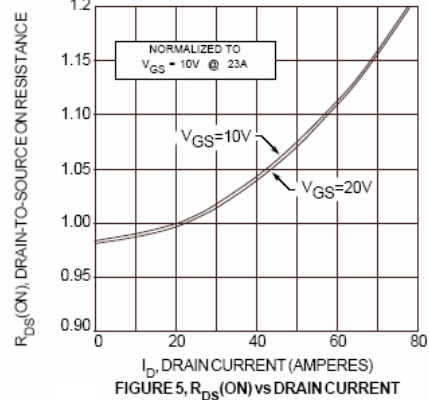
**Typical MOSFET Performance Curve**

**FIGURE 1, MAXIMUM EFFECTIVE TRANSIENT THERMAL IMPEDANCE, JUNCTION-TO-CASE vs PULSE DURATION**

**FIGURE 2, TRANSIENT THERMAL IMPEDANCE MODEL**

**FIGURE 4, TRANSFER CHARACTERISTICS**

**FIGURE 3, LOW VOLTAGE OUTPUT CHARACTERISTICS**

**FIGURE 5,  $R_{DS}(ON)$  vs DRAIN CURRENT**

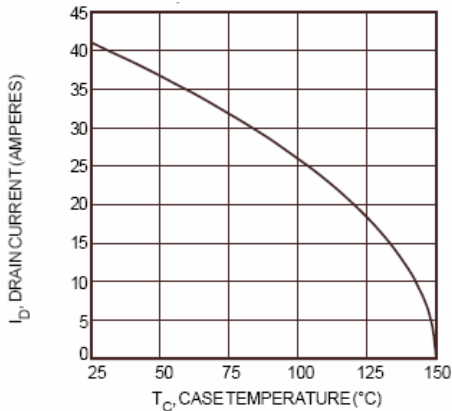

FIGURE 6, MAXIMUM DRAIN CURRENT vs CASE TEMPERATURE

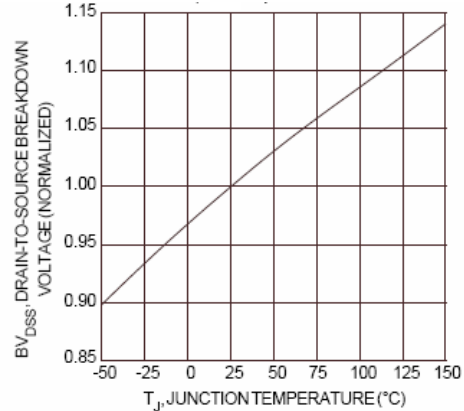

FIGURE 7, BREAKDOWN VOLTAGE vs TEMPERATURE

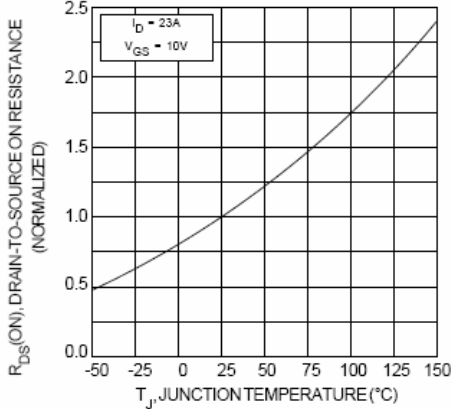

FIGURE 8, ON-RESISTANCE vs. TEMPERATURE

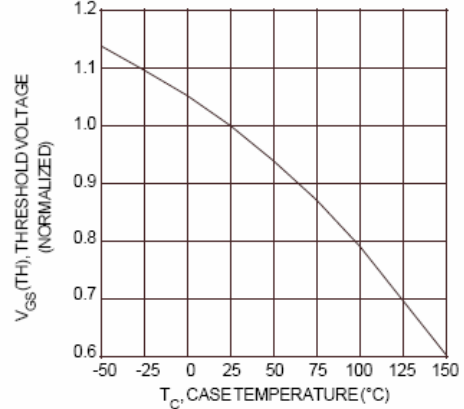

FIGURE 9, THRESHOLD VOLTAGE vs TEMPERATURE

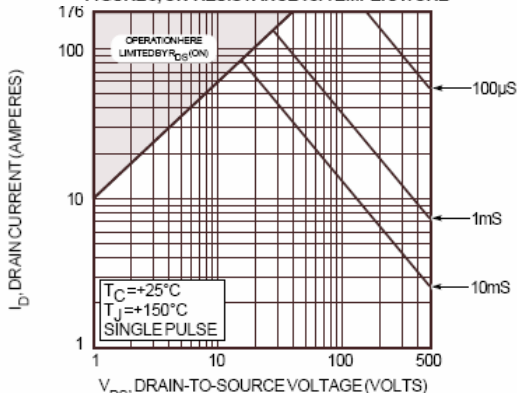

FIGURE 10, MAXIMUM SAFE OPERATING AREA

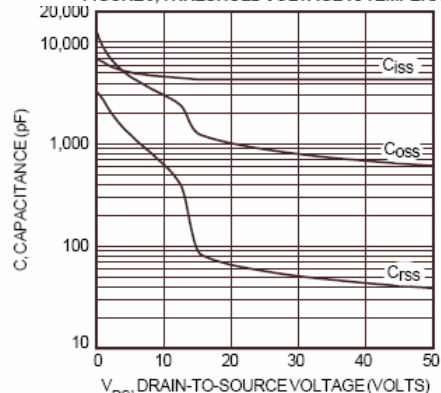

FIGURE 11, CAPACITANCE vs DRAIN-TO-SOURCE VOLTAGE

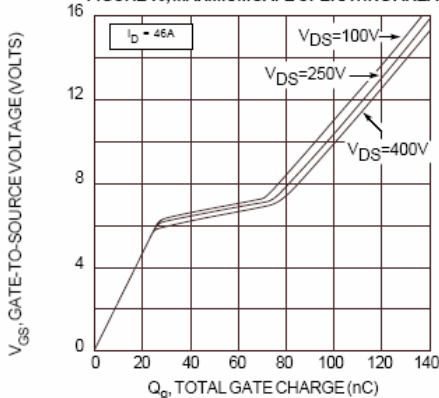

FIGURE 12, GATE CHARGES vs GATE-TO-SOURCE VOLTAGE

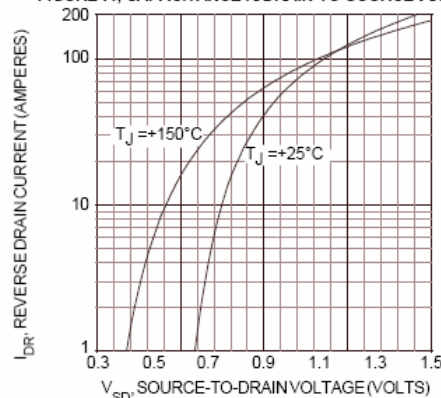

FIGURE 13, SOURCE-DRAIN DIODE FORWARD VOLTAGE

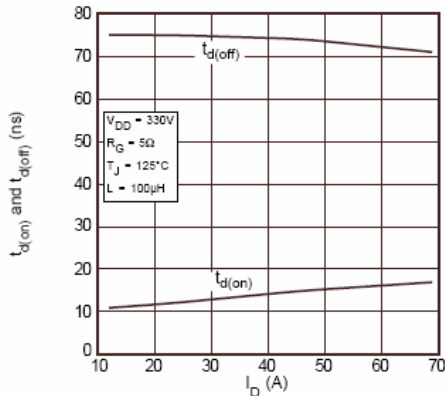

FIGURE 14, DELAY TIMES vs CURRENT

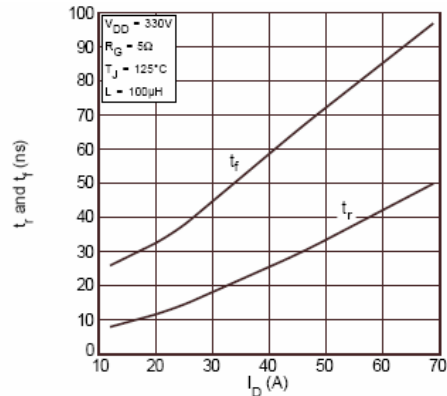

FIGURE 15, RISE AND FALL TIMES vs CURRENT

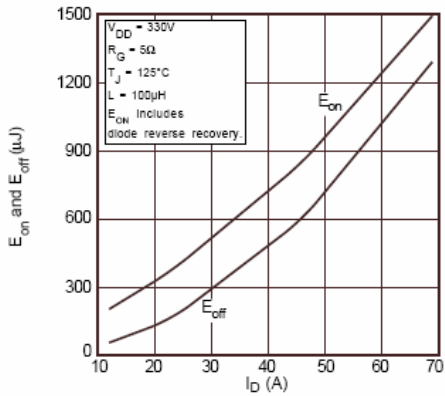

FIGURE 16, SWITCHING ENERGY vs CURRENT

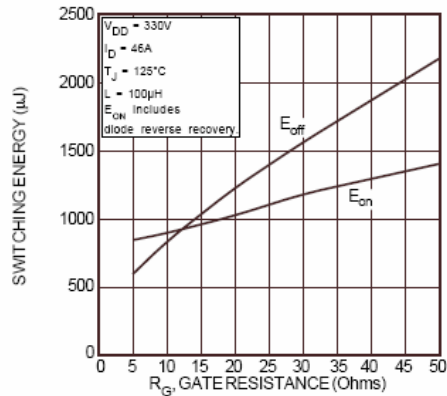

FIGURE 17, SWITCHING ENERGY vs. GATE RESISTANCE

### Typical Diode Performance Curve

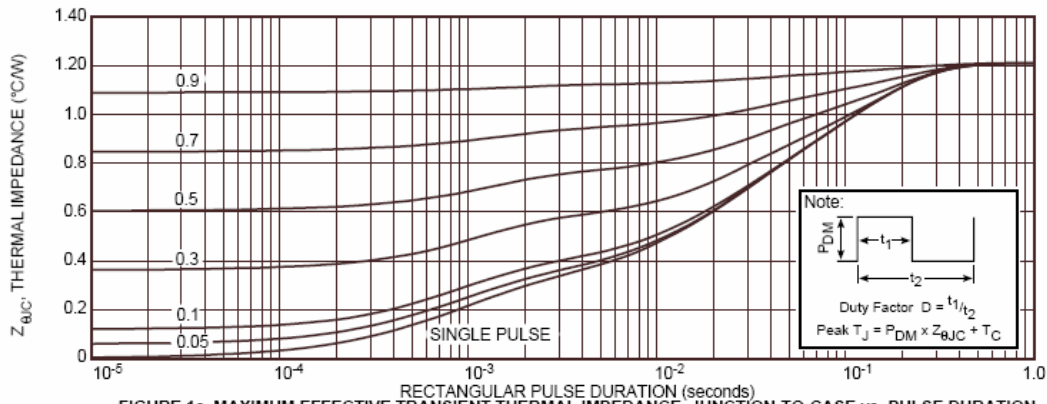

FIGURE 1a. MAXIMUM EFFECTIVE TRANSIENT THERMAL IMPEDANCE, JUNCTION-TO-CASE vs. PULSE DURATION

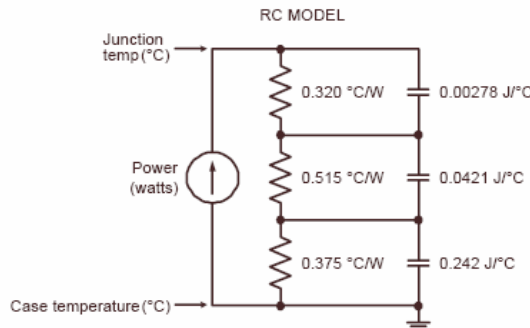

FIGURE 1b, TRANSIENT THERMAL IMPEDANCE MODEL

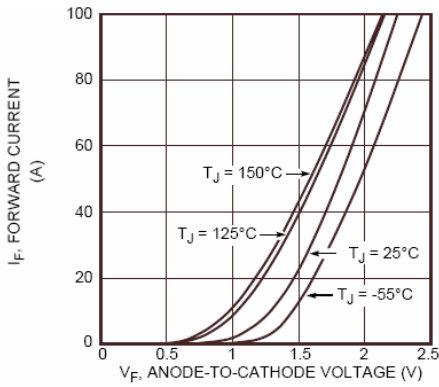

Figure 2. Forward Current vs. Forward Voltage

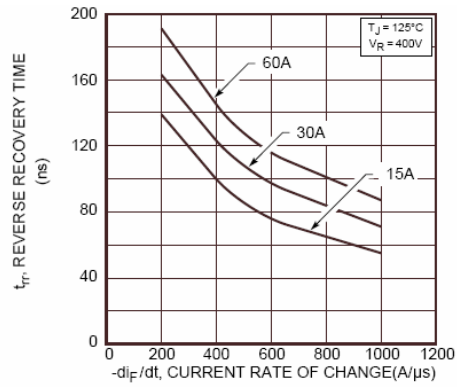

Figure 3. Reverse Recovery Time vs. Current Rate of Change

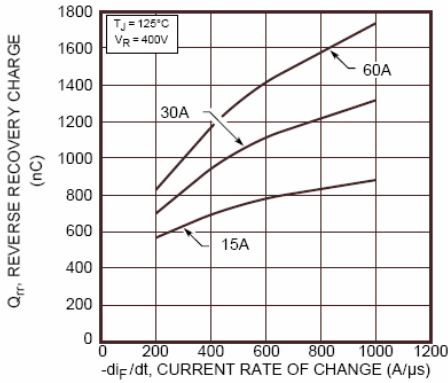

Figure 4. Reverse Recovery Charge vs. Current Rate of Change

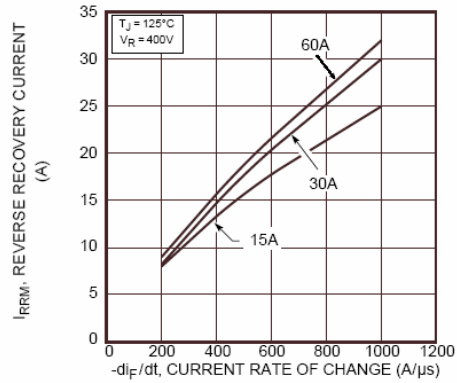

Figure 5. Reverse Recovery Current vs. Current Rate of Change

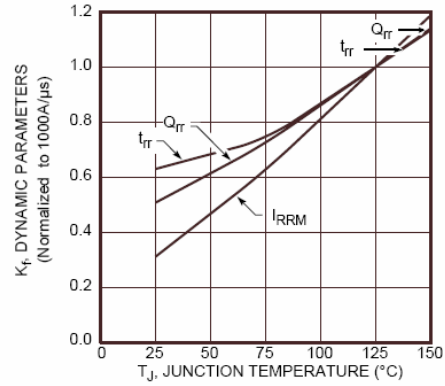

Figure 6. Dynamic Parameters vs. Junction Temperature

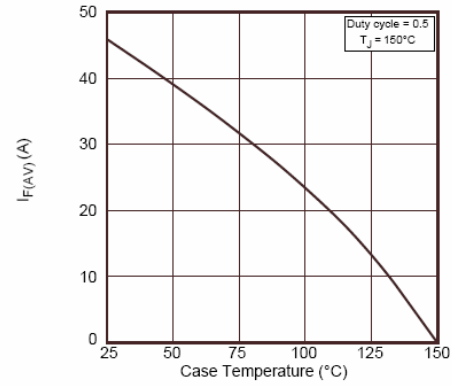

Figure 7. Maximum Average Forward Current vs. Case Temperature

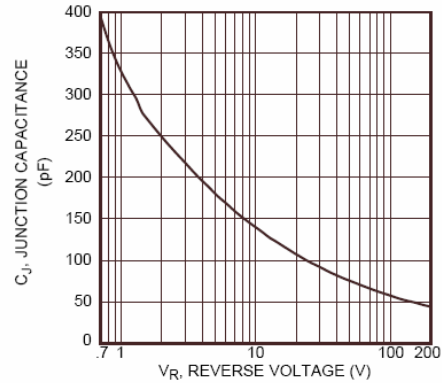

Figure 8. Junction Capacitance vs. Reverse Voltage

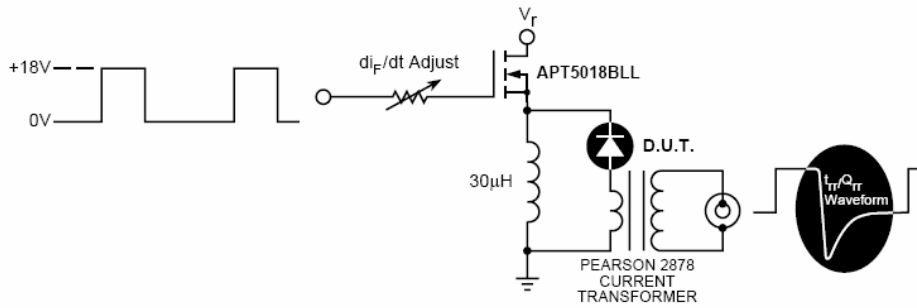

Figure 9. Diode Test Circuit

- 1  $I_F$  - Forward Conduction Current
- 2  $di_F/dt$  - Rate of Diode Current Change Through Zero Crossing.
- 3  $I_{RRM}$  - Maximum Reverse Recovery Current.
- 4  $t_{rr}$  - Reverse Recovery Time, measured from zero crossing where diode current goes from positive to negative, to the point at which the straight line through  $I_{RRM}$  and  $0.25 \cdot I_{RRM}$  passes through zero.
- 5  $Q_{rr}$  - Area Under the Curve Defined by  $I_{RRM}$  and  $t_{rr}$ .

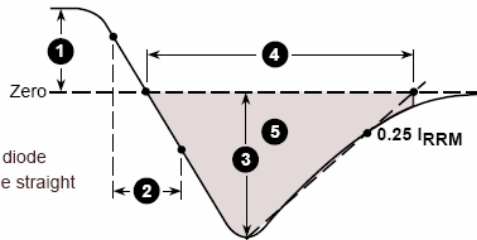
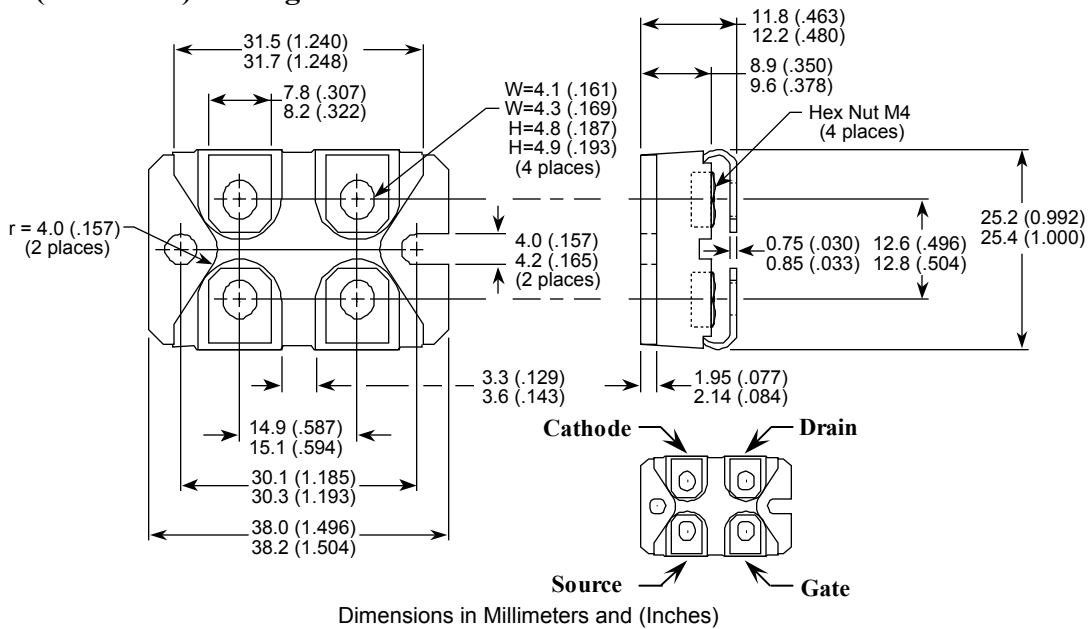

Figure 10. Diode Reverse Recovery Waveform and Definitions

### SOT-227 (ISOTOP<sup>®</sup>) Package Outline



ISOTOP<sup>®</sup> is a registered trademark of ST Microelectronics NV

Microsemi reserves the right to change, without notice, the specifications and information contained herein

Microsemi's products are covered by one or more of U.S. patents 4,895,810 5,045,903 5,089,434 5,182,234 5,019,522 5,262,336 6,503,786 5,256,583 4,748,103 5,283,202 5,231,474 5,434,095 5,528,058 and foreign patents. U.S. and Foreign patents pending. All Rights Reserved.