

**Dual Buck chopper  
Super Junction MOSFET  
Power Module**

**$V_{DSS} = 800V$   
 $R_{DSon} = 290m\Omega \text{ max @ } T_j = 25^\circ C$   
 $I_D = 15A \text{ @ } T_c = 25^\circ C$**

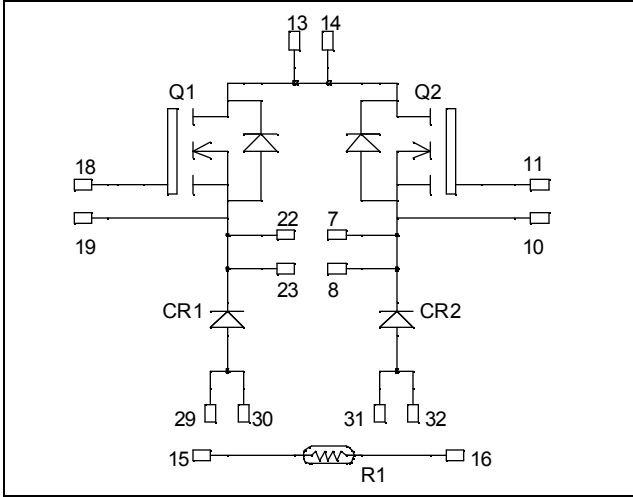

**Application**

- AC and DC motor control
- Switched Mode Power Supplies

**Features**

- **COOLMOS** Power Semiconductors
  - Ultra low  $R_{DSon}$
  - Low Miller capacitance
  - Ultra low gate charge
  - Avalanche energy rated
  - Very rugged
- Kelvin source for easy drive
- Very low stray inductance
  - Symmetrical design
- Internal thermistor for temperature monitoring
- High level of integration

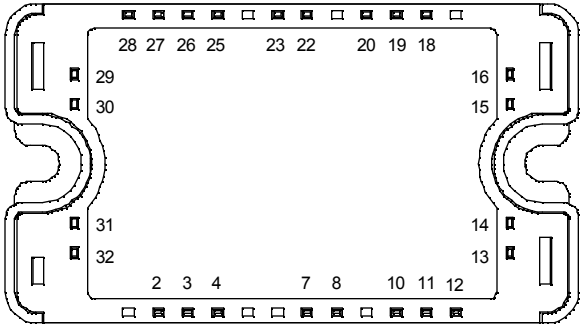

**Benefits**

- Outstanding performance at high frequency operation
- Direct mounting to heatsink (isolated package)
- Low junction to case thermal resistance
- Solderable terminals both for power and signal for easy PCB mounting
- Low profile
- Each leg can be easily paralleled to achieve a single buck of twice the current capability

All multiple inputs and outputs must be shorted together  
Example: 13/14 ; 29/30 ; 22/23 ...

**Absolute maximum ratings**

Symbol	Parameter	Max ratings	Unit
$V_{DSS}$	Drain - Source Breakdown Voltage	800	V
$I_D$	Continuous Drain Current	$T_c = 25^\circ C$	15
		$T_c = 80^\circ C$	11
$I_{DM}$	Pulsed Drain current	60	
$V_{GS}$	Gate - Source Voltage	$\pm 30$	V
$R_{DSon}$	Drain - Source ON Resistance	290	$m\Omega$
$P_D$	Maximum Power Dissipation	$T_c = 25^\circ C$	156
$I_{AR}$	Avalanche current (repetitive and non repetitive)	24	A
$E_{AR}$	Repetitive Avalanche Energy	0.5	mJ
$E_{AS}$	Single Pulse Avalanche Energy	670	

**CAUTION:** These Devices are sensitive to Electrostatic Discharge. Proper Handling Procedures Should Be Followed.

All ratings @  $T_j = 25^\circ\text{C}$  unless otherwise specified

## Electrical Characteristics

Symbol	Characteristic	Test Conditions	Min	Typ	Max	Unit
$BV_{DSS}$	Drain - Source Breakdown Voltage	$V_{GS} = 0V, I_D = 250\mu A$	800			V
$I_{DSS}$	Zero Gate Voltage Drain Current	$V_{GS} = 0V, V_{DS} = 800V, T_j = 25^\circ\text{C}$			25	$\mu A$
		$V_{GS} = 0V, V_{DS} = 800V, T_j = 125^\circ\text{C}$			250	
$R_{DS(on)}$	Drain - Source on Resistance	$V_{GS} = 10V, I_D = 7.5A$			290	$m\Omega$
$V_{GS(th)}$	Gate Threshold Voltage	$V_{GS} = V_{DS}, I_D = 1mA$	2.1	3	3.9	V
$I_{GSS}$	Gate - Source Leakage Current	$V_{GS} = \pm 20V, V_{DS} = 0V$			$\pm 100$	nA

## Dynamic Characteristics

Symbol	Characteristic	Test Conditions	Min	Typ	Max	Unit
$C_{iss}$	Input Capacitance	$V_{GS} = 0V$		2254		pF
$C_{oss}$	Output Capacitance	$V_{DS} = 25V$		1046		
$C_{rss}$	Reverse Transfer Capacitance	$f = 1MHz$		54		
$Q_g$	Total gate Charge	$V_{GS} = 10V$ $V_{Bus} = 400V$ $I_D = 15A$		90		nC
$Q_{gs}$	Gate - Source Charge			11		
$Q_{gd}$	Gate - Drain Charge			45		
$T_{d(on)}$	Turn-on Delay Time	<b>Inductive switching @125°C</b> $V_{GS} = 15V$ $V_{Bus} = 533V$ $I_D = 15A$ $R_G = 5\Omega$		10		ns
$T_r$	Rise Time			13		
$T_{d(off)}$	Turn-off Delay Time			83		
$T_f$	Fall Time			35		
$E_{on}$	Turn-on Switching Energy ❶	<b>Inductive switching @ 25°C</b> $V_{GS} = 15V, V_{Bus} = 533V$ $I_D = 15A, R_G = 5\Omega$		243		$\mu J$
$E_{off}$	Turn-off Switching Energy ❷			139		
$E_{on}$	Turn-on Switching Energy ❶	<b>Inductive switching @ 125°C</b> $V_{GS} = 15V, V_{Bus} = 533V$ $I_D = 15A, R_G = 5\Omega$		425		$\mu J$
$E_{off}$	Turn-off Switching Energy ❷			171		

## Diode ratings and characteristics

Symbol	Characteristic	Test Conditions	Min	Typ	Max	Unit
$V_{RRM}$	Maximum Peak Repetitive Reverse Voltage		1000			V
$I_{RM}$	Maximum Reverse Leakage Current	$V_R = 1000V$	$T_j = 25^\circ\text{C}$		250	$\mu A$
			$T_j = 125^\circ\text{C}$		750	
$I_{F(AV)}$	Maximum Average Forward Current	50% duty cycle, $T_c = 70^\circ\text{C}$		30		A
$V_F$	Diode Forward Voltage	$I_F = 30A$		1.9	2.3	V
		$I_F = 60A$		2.2		
		$I_F = 30A, T_j = 125^\circ\text{C}$		1.7		
$t_{rr}$	Reverse Recovery Time	$I_F = 30A$ $V_R = 667V$ $di/dt = 200A/\mu s$	$T_j = 25^\circ\text{C}$	290		ns
			$T_j = 125^\circ\text{C}$	390		
$Q_{rr}$	Reverse Recovery Charge	$I_F = 30A$ $V_R = 667V$ $di/dt = 200A/\mu s$	$T_j = 25^\circ\text{C}$	670		nC
			$T_j = 125^\circ\text{C}$	2350		

❶  $E_{on}$  includes diode reverse recovery.

❷ In accordance with JEDEC standard JESD24-1.

**Thermal and package characteristics**

Symbol	Characteristic	Min	Typ	Max	Unit
R <sub>thJC</sub>	Junction to Case	IGBT		0.8	°C/W
		Diode		1.2	
V <sub>ISOL</sub>	RMS Isolation Voltage, any terminal to case t =1 min, I <sub>isol</sub> <1mA, 50/60Hz	2500			V
T <sub>J</sub>	Operating junction temperature range	-40		150	°C
T <sub>STG</sub>	Storage Temperature Range	-40		125	
T <sub>C</sub>	Operating Case Temperature	-40		100	
Torque	Mounting torque		To heatsink	M4	
Wt	Package Weight				110 g

**Temperature sensor NTC**

Symbol	Characteristic	Min	Typ	Max	Unit
R <sub>25</sub>	Resistance @ 25°C		68		kΩ
B <sub>25/85</sub>	T <sub>25</sub> = 298.16 K		4080		K

$$R_T = \frac{R_{25}}{\exp \left[ B_{25/85} \left( \frac{1}{T_{25}} - \frac{1}{T} \right) \right]}$$

T: Thermistor temperature  
R<sub>T</sub>: Thermistor value at T

**Package outline**

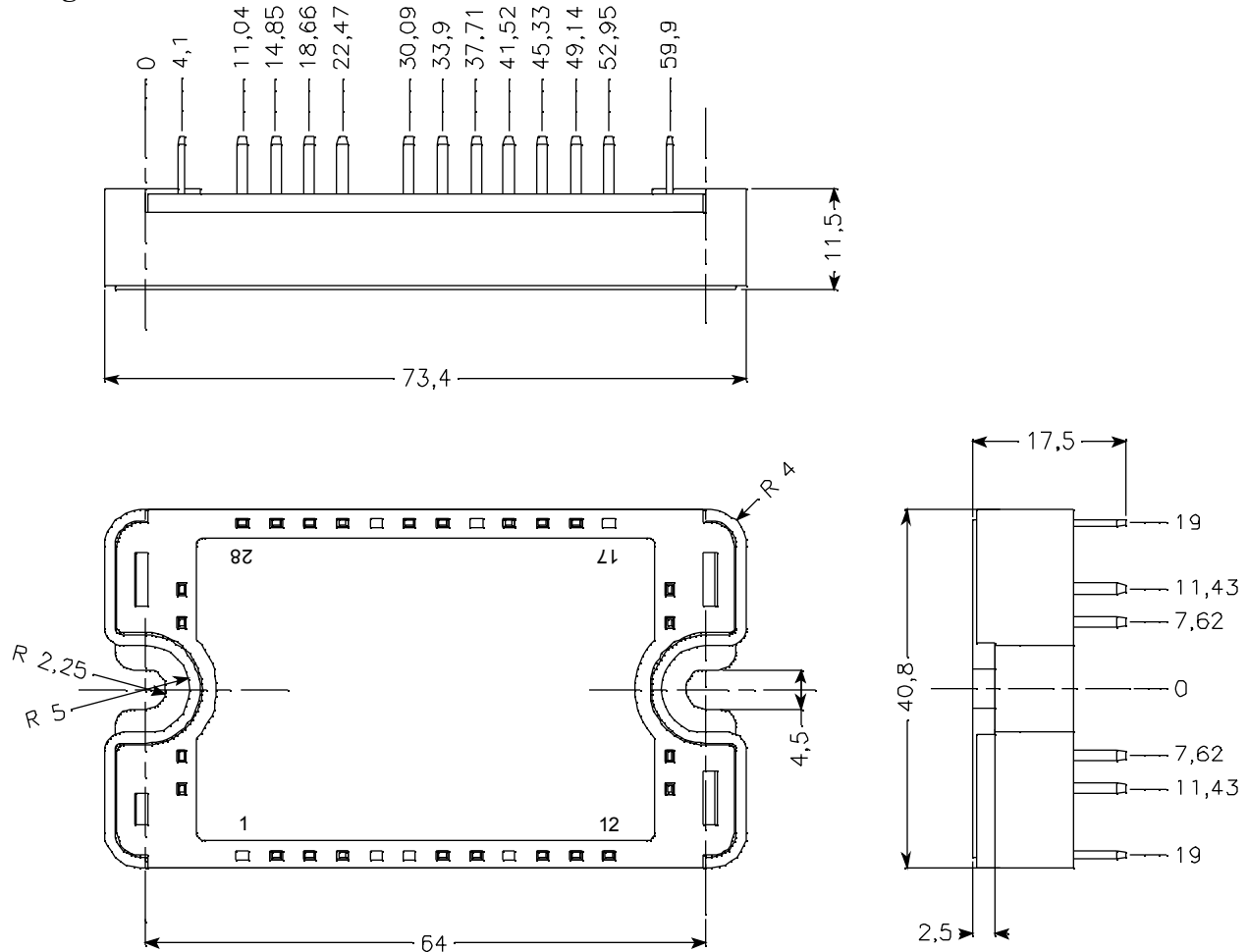

**Typical performance Curve**

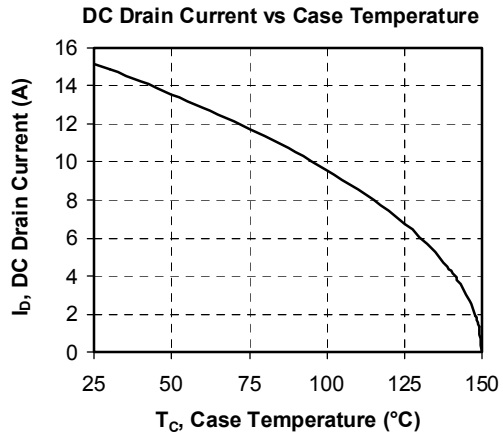
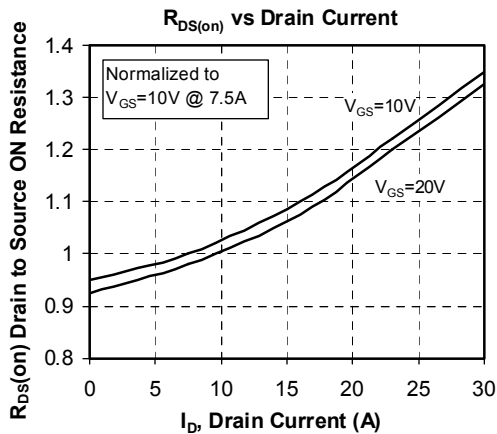
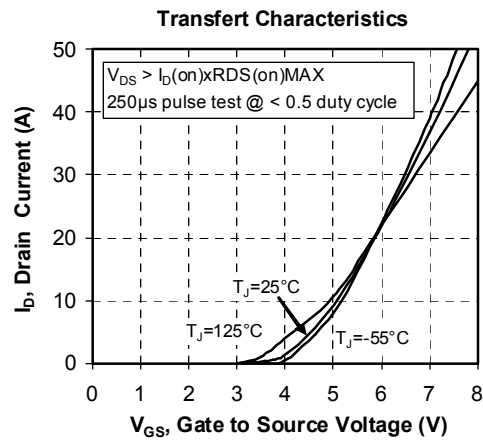
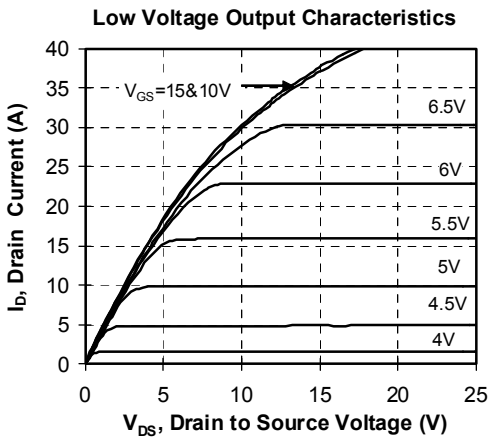
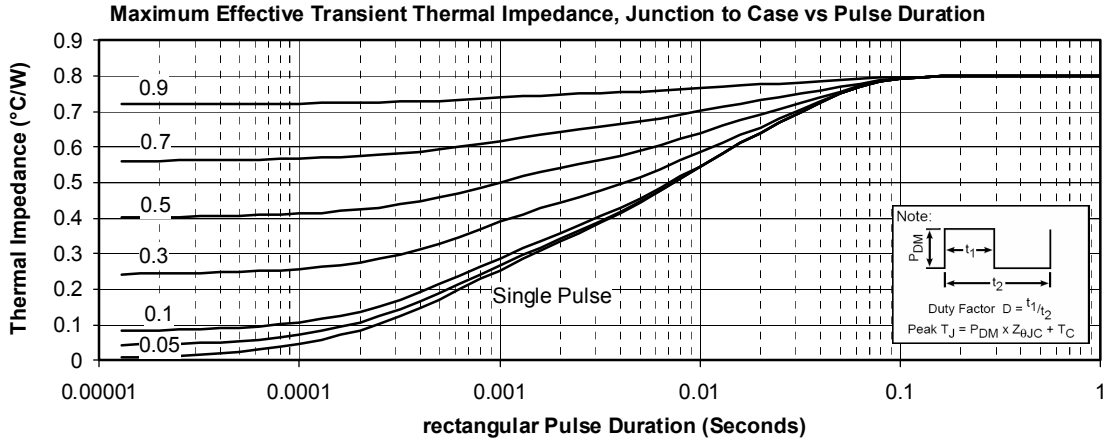

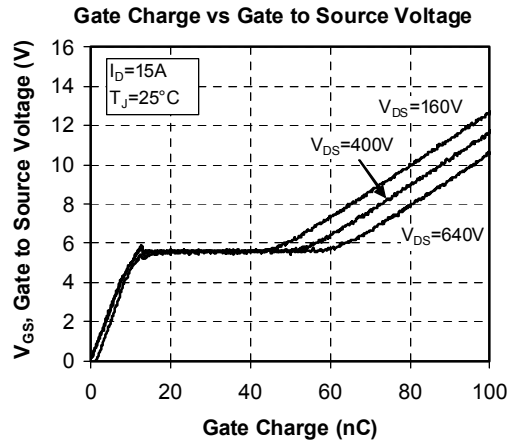
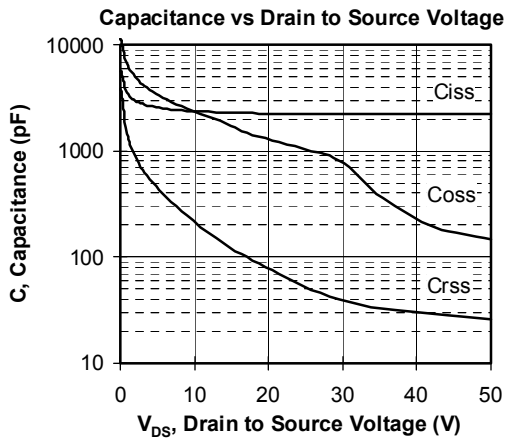
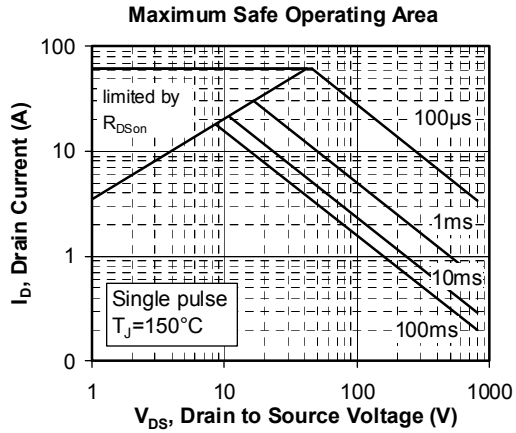
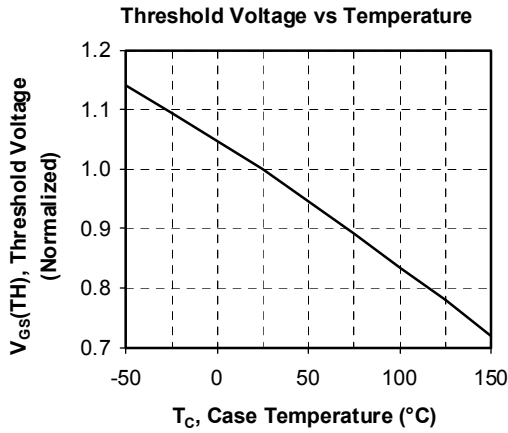
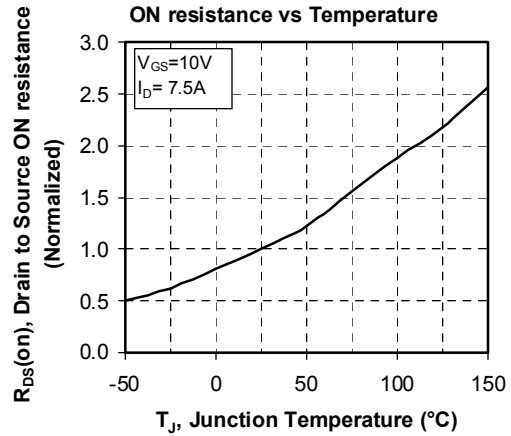
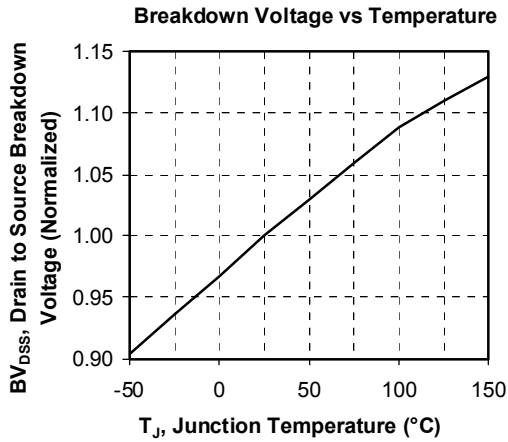

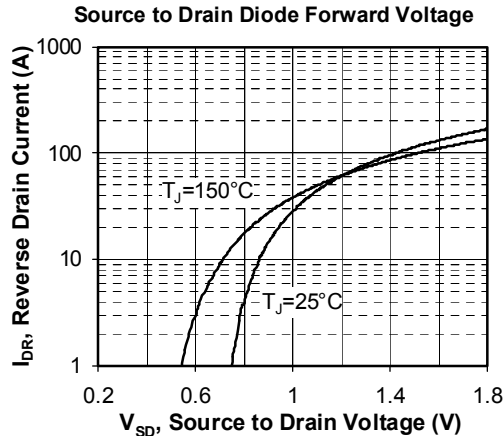
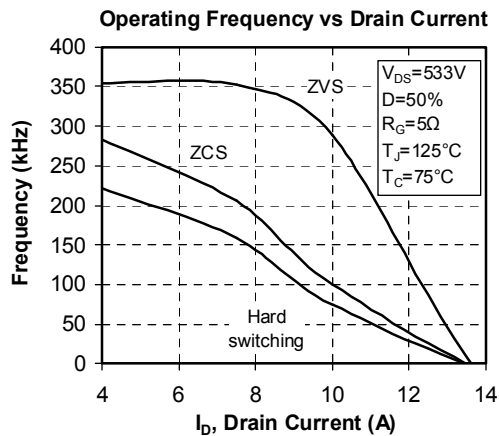
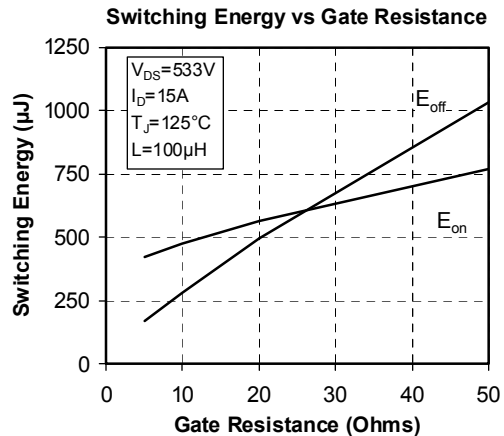
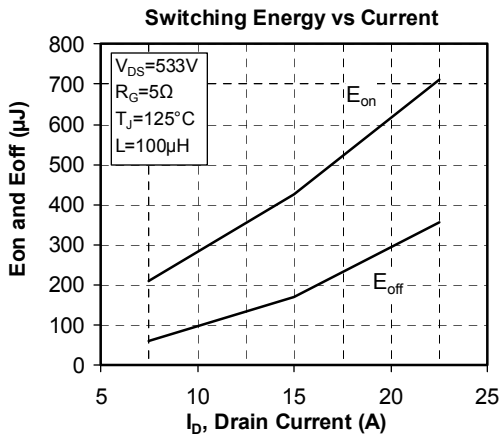
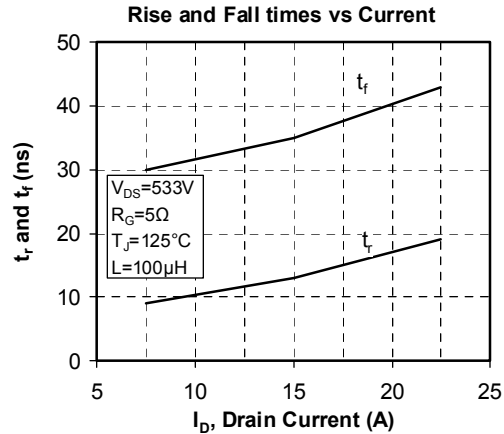
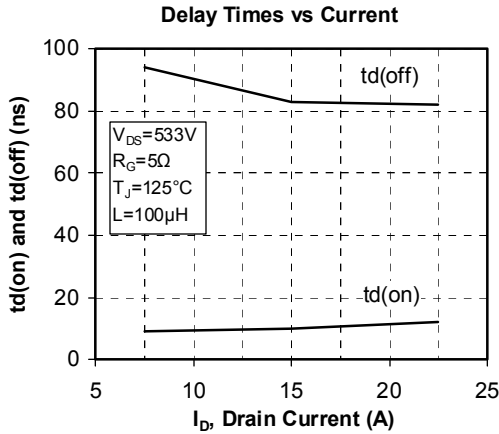

“COOLMOS™ comprise a new family of transistors developed by Infineon Technologies AG. “COOLMOS” is a trademark of Infineon Technologies AG”.

APT reserves the right to change, without notice, the specifications and information contained herein

APT's products are covered by one or more of U.S. patents 4,895,810 5,045,903 5,089,434 5,182,234 5,019,522 5,262,336 6,503,786 5,256,583 4,748,103 5,283,202 5,231,474 5,434,095 5,528,058 and foreign patents. U.S. and Foreign patents pending. All Rights Reserved.