

Dual common source NPT IGBT Power Module

$V_{CES} = 600V$
 $I_C = 350A @ T_c = 80^\circ C$

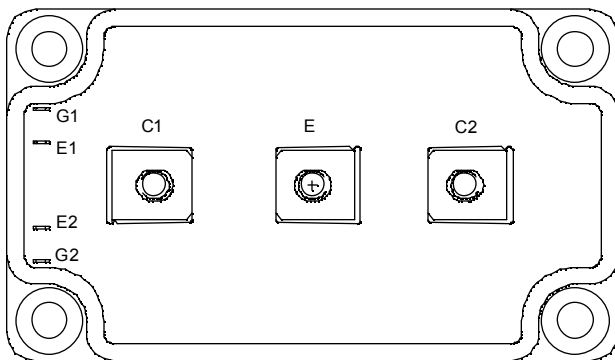
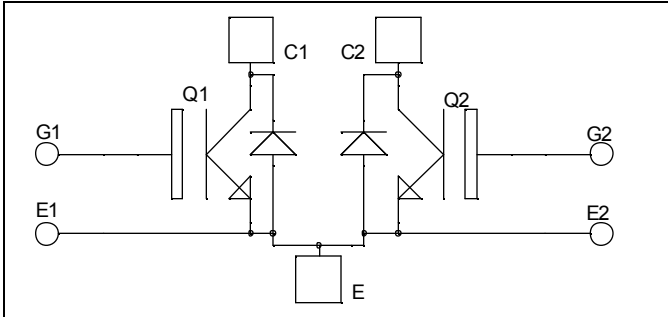

Application

- AC Switches
- Switched Mode Power Supplies
- Uninterruptible Power Supplies

Features

- Non Punch Through (NPT) Fast IGBT®
 - Low voltage drop
 - Low tail current
 - Switching frequency up to 100 kHz
 - Soft recovery parallel diodes
 - Low diode VF
 - Low leakage current
 - Avalanche energy rated
 - RBSOA and SCSOA rated
- Kelvin emitter for easy drive
- Very low stray inductance
 - Symmetrical design
 - M5 power connectors
- High level of integration

Benefits

- Outstanding performance at high frequency operation
- Stable temperature behavior
- Very rugged
- Direct mounting to heatsink (isolated package)
- Low junction to case thermal resistance
- Easy paralleling due to positive TC of VCEsat
- Low profile
- RoHS compliant

Absolute maximum ratings

Symbol	Parameter	Max ratings	Unit
V_{CES}	Collector - Emitter Breakdown Voltage	600	V
I_C	Continuous Collector Current	$T_c = 25^\circ C$	430
		$T_c = 80^\circ C$	350
I_{CM}	Pulsed Collector Current	$T_c = 25^\circ C$	1225
V_{GE}	Gate - Emitter Voltage	± 20	V
P_D	Maximum Power Dissipation	$T_c = 25^\circ C$	1562
RBSOA	Reverse Bias Safe Operating Area	$T_j = 150^\circ C$	800A @ 600V

 **CAUTION:** These Devices are sensitive to Electrostatic Discharge. Proper Handling Procedures Should Be Followed. See application note APT0502 on www.microsemi.com

All ratings @ $T_j = 25^\circ\text{C}$ unless otherwise specified

Electrical Characteristics

Symbol	Characteristic	Test Conditions	Min	Typ	Max	Unit
I_{CES}	Zero Gate Voltage Collector Current	$V_{GE} = 0\text{V}$ $V_{CE} = 600\text{V}$	$T_j = 25^\circ\text{C}$		200	μA
			$T_j = 125^\circ\text{C}$		1750	
$V_{CE(sat)}$	Collector Emitter saturation Voltage	$V_{GE} = 15\text{V}$ $I_C = 360\text{A}$	$T_j = 25^\circ\text{C}$	2.0	2.5	V
			$T_j = 125^\circ\text{C}$	2.2		
$V_{GE(th)}$	Gate Threshold Voltage	$V_{GE} = V_{CE}, I_C = 4\text{mA}$	3		5	V
I_{GES}	Gate – Emitter Leakage Current	$V_{GE} = \pm 20\text{V}, V_{CE} = 0\text{V}$			± 300	nA

Dynamic Characteristics

Symbol	Characteristic	Test Conditions	Min	Typ	Max	Unit
C_{ies}	Input Capacitance	$V_{GE} = 0\text{V}$ $V_{CE} = 25\text{V}$ $f = 1\text{MHz}$		17.2		nF
C_{oes}	Output Capacitance			1.88		
C_{res}	Reverse Transfer Capacitance			1.6		
Q_g	Total gate Charge	$V_{GE} = 15\text{V}$ $V_{Bus} = 300\text{V}$ $I_C = 360\text{A}$		1320		nC
Q_{ge}	Gate – Emitter Charge			1160		
Q_{gc}	Gate – Collector Charge			800		
$T_{d(on)}$	Turn-on Delay Time	Inductive Switching (25°C) $V_{GE} = 15\text{V}$ $V_{Bus} = 400\text{V}$ $I_C = 360\text{A}$ $R_G = 1.25\Omega$		26		ns
T_r	Rise Time			25		
$T_{d(off)}$	Turn-off Delay Time			150		
T_f	Fall Time			30		
$T_{d(on)}$	Turn-on Delay Time	Inductive Switching (125°C) $V_{GE} = 15\text{V}$ $V_{Bus} = 400\text{V}$ $I_C = 360\text{A}$ $R_G = 1.25\Omega$		26		ns
T_r	Rise Time			25		
$T_{d(off)}$	Turn-off Delay Time			170		
T_f	Fall Time			40		
E_{on}	Turn-on Switching Energy	$V_{GE} = 15\text{V}$ $V_{Bus} = 400\text{V}$ $I_C = 360\text{A}$ $R_G = 1.25\Omega$	$T_j = 125^\circ\text{C}$	17.2		mJ
E_{off}	Turn-off Switching Energy		$T_j = 125^\circ\text{C}$	14		

Diode ratings and characteristics

Symbol	Characteristic	Test Conditions	Min	Typ	Max	Unit	
V_{RRM}	Maximum Peak Repetitive Reverse Voltage		600			V	
I_{RM}	Maximum Reverse Leakage Current	$V_R = 600\text{V}$	$T_j = 25^\circ\text{C}$		750	μA	
			$T_j = 125^\circ\text{C}$		1500		
I_F	DC Forward Current			400		A	
V_F	Diode Forward Voltage	$I_F = 400\text{A}$			1.6	1.8	V
		$I_F = 800\text{A}$			1.9		
		$I_F = 400\text{A}$	$T_j = 125^\circ\text{C}$		1.4		
t_{rr}	Reverse Recovery Time	$I_F = 400\text{A}$ $V_R = 400\text{V}$ $di/dt = 800\text{A}/\mu\text{s}$	$T_j = 25^\circ\text{C}$		180	ns	
	$T_j = 125^\circ\text{C}$			220			
Q_{rr}	Reverse Recovery Charge		$T_j = 25^\circ\text{C}$		1560		nC
		$T_j = 125^\circ\text{C}$		5800			

Thermal and package characteristics
Symbol Characteristic

			<i>Min</i>	<i>Typ</i>	<i>Max</i>	<i>Unit</i>
R_{thJC}	Junction to Case Thermal Resistance	IGBT			0.08	°C/W
		Diode			0.16	
V_{ISOL}	RMS Isolation Voltage, any terminal to case $t=1$ min, $I_{isol}<1$ mA, 50/60Hz		2500			V
T_J	Operating junction temperature range		-40		150	°C
T_{STG}	Storage Temperature Range		-40		125	
T_C	Operating Case Temperature		-40		100	
Torque	Mounting torque	To heatsink	M6	3	5	N.m
		For terminals	M5	2	3.5	
Wt	Package Weight				280	g

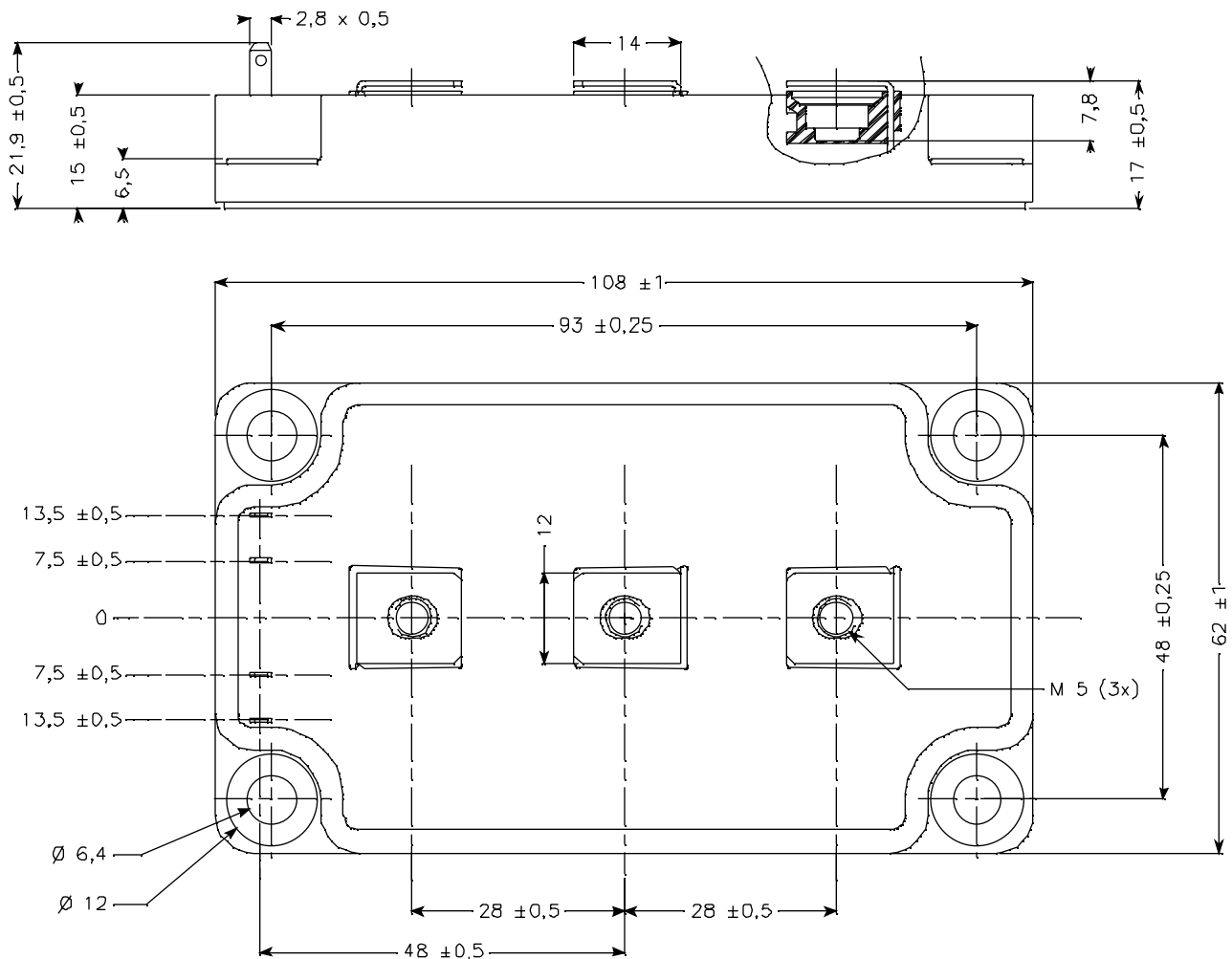
SP6 Package outline (dimensions in mm)

 See application note APT0601 - Mounting Instructions for SP6 Power Modules on www.microsemi.com

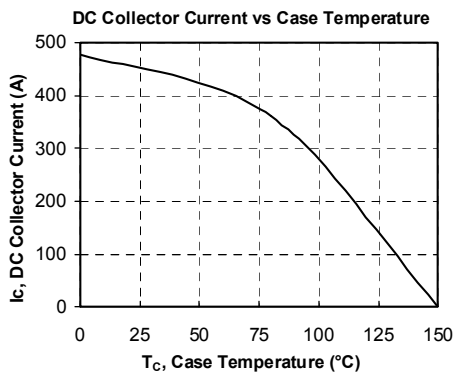
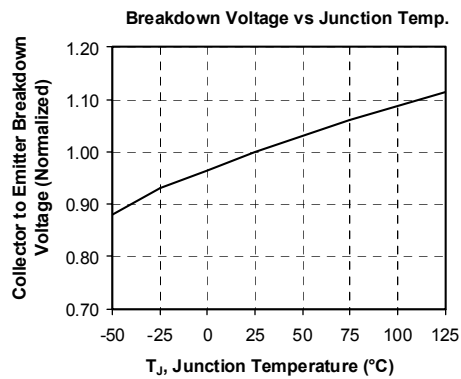
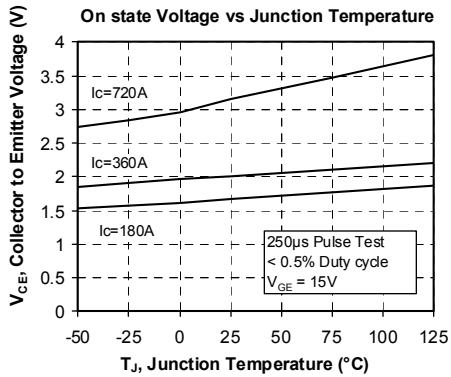
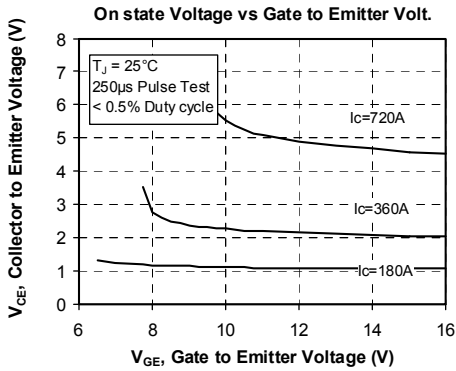
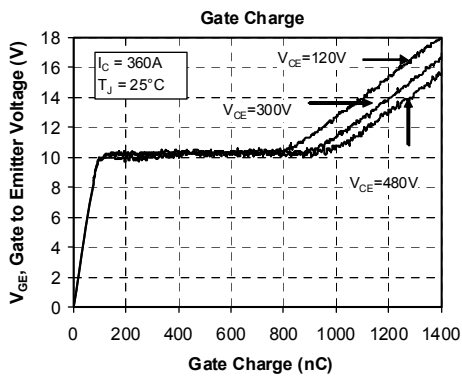
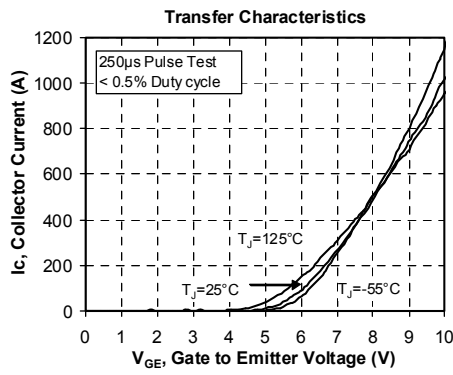
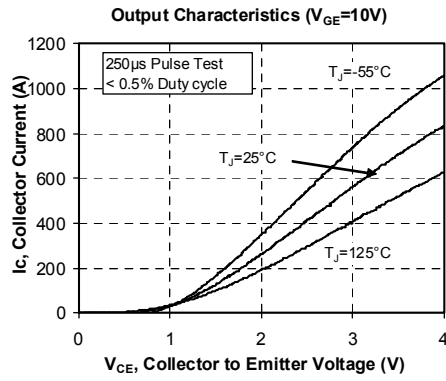
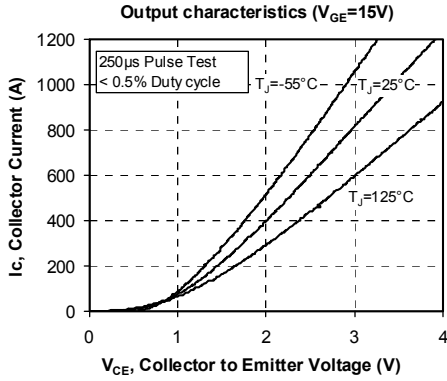
Typical Performance Curve

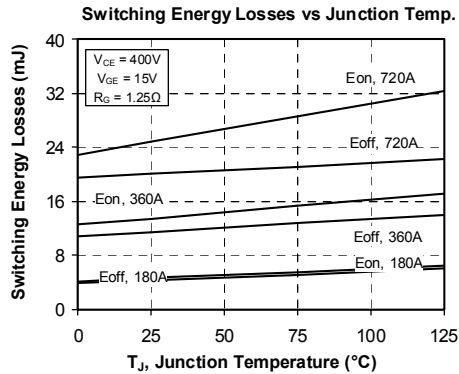
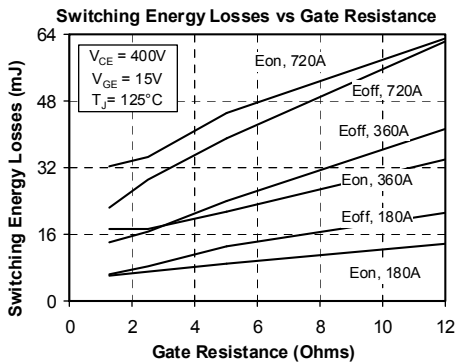
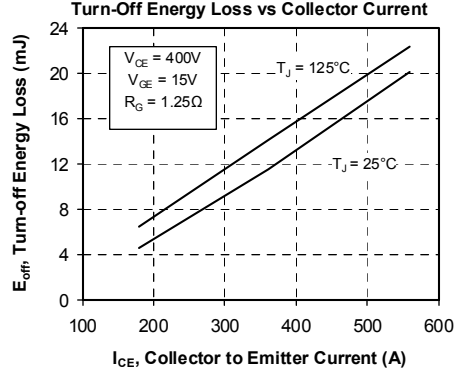
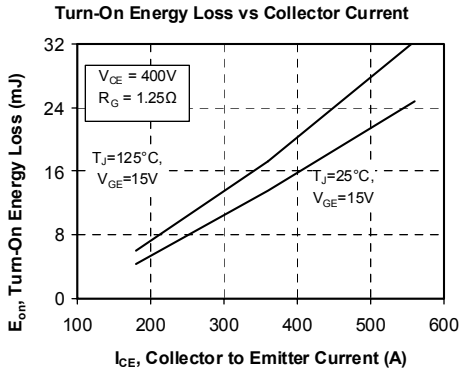
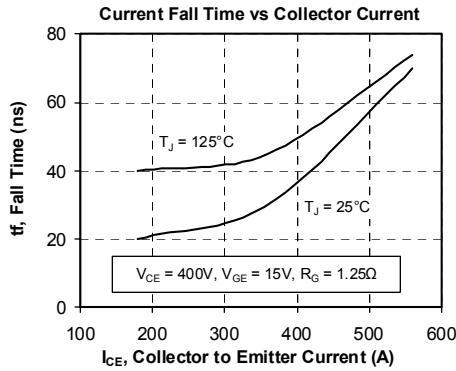
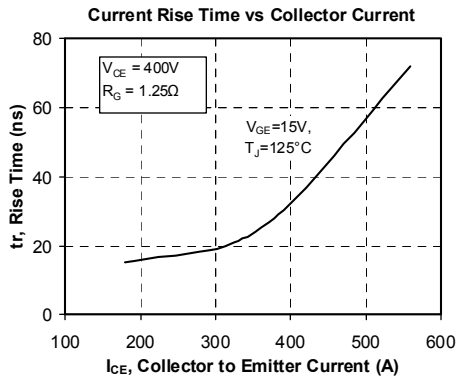
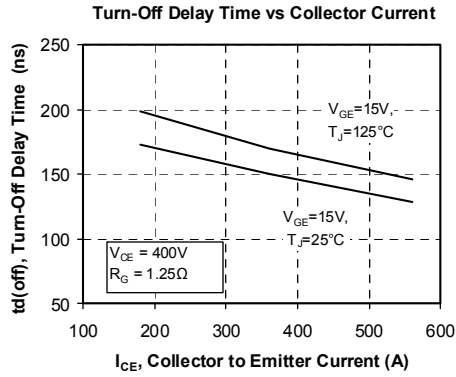
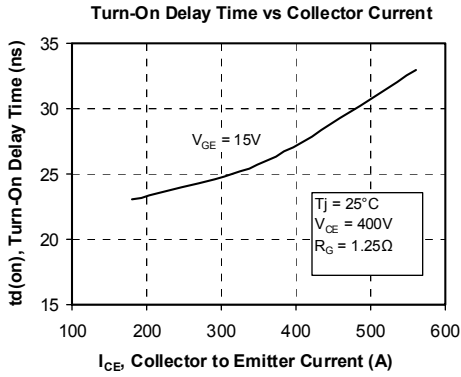

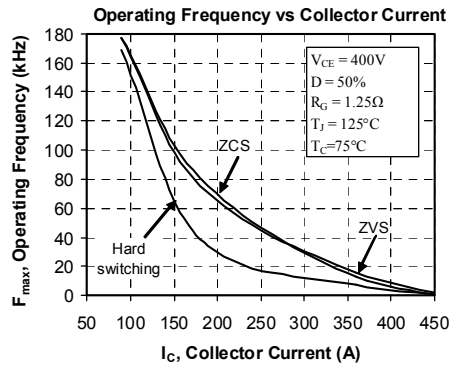
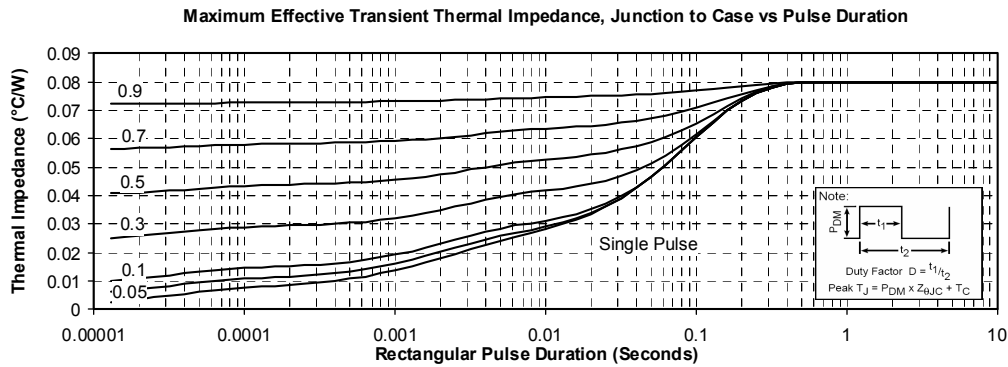
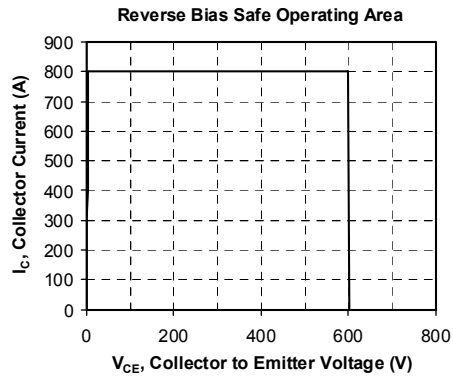
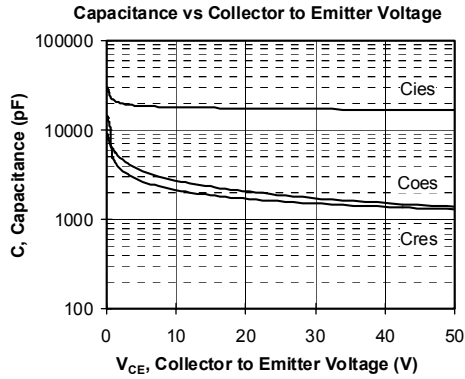



Microsemi reserves the right to change, without notice, the specifications and information contained herein

Microsemi's products are covered by one or more of U.S. patents 4,895,810 5,045,903 5,089,434 5,182,234 5,019,522 5,262,336 6,503,786 5,256,583 4,748,103 5,283,202 5,231,474 5,434,095 5,528,058 and foreign patents. U.S. and Foreign patents pending. All Rights Reserved.