

Phase leg
Trench + Field Stop IGBT®
Power Module

www.datasheet4u.com

$V_{CES} = 600V$
 $I_C = 300A @ T_c = 80^\circ C$

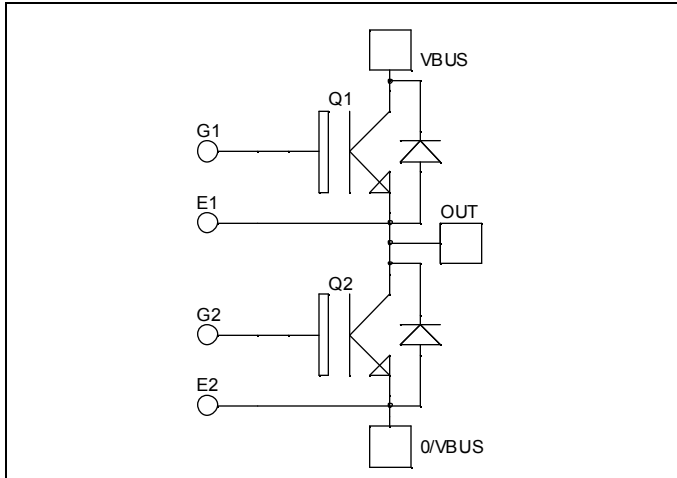

Application

- Welding converters
- Switched Mode Power Supplies
- Uninterruptible Power Supplies
- Motor control

Features

- Trench + Field Stop IGBT® Technology
 - Low voltage drop
 - Low tail current
 - Switching frequency up to 20 kHz
 - Soft recovery parallel diodes
 - Low diode VF
 - Low leakage current
 - Avalanche energy rated
 - RBSOA and SCSOA rated
- Kelvin emitter for easy drive
- Very low stray inductance
 - Symmetrical design
 - M5 power connectors
- High level of integration

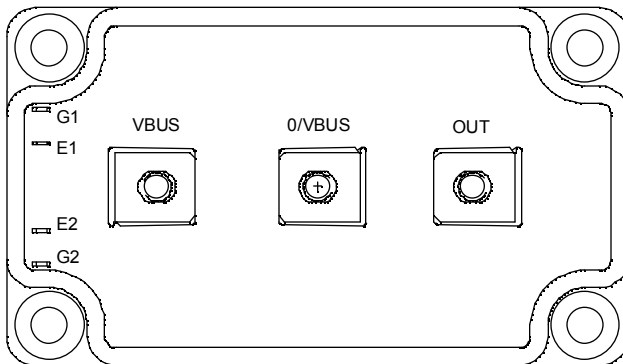

Benefits

- Stable temperature behavior
- Very rugged
- Direct mounting to heatsink (isolated package)
- Low junction to case thermal resistance
- Easy paralleling due to positive TC of VCEsat
- Low profile
- RoHS Compliant

Absolute maximum ratings

Symbol	Parameter	Max ratings	Unit
V_{CES}	Collector - Emitter Breakdown Voltage	600	V
I_C	Continuous Collector Current	$T_C = 25^\circ C$	430
		$T_C = 80^\circ C$	300
I_{CM}	Pulsed Collector Current	$T_C = 25^\circ C$	500
V_{GE}	Gate - Emitter Voltage	± 20	V
P_D	Maximum Power Dissipation	$T_C = 25^\circ C$	1150
RBSOA	Reverse Bias Safe Operating Area	$T_j = 150^\circ C$	600A @ 550V



CAUTION: These Devices are sensitive to Electrostatic Discharge. Proper Handling Procedures Should Be Followed. See application note APT0502 on www.microsemi.com

All ratings @ $T_j = 25^\circ\text{C}$ unless otherwise specified

Electrical Characteristics

Symbol	Characteristic	Test Conditions	Min	Typ	Max	Unit
I_{CES}	Zero Gate Voltage Collector Current	$V_{GE} = 0\text{V}, V_{CE} = 600\text{V}$			350	μA
$V_{CE(sat)}$	Collector Emitter Saturation Voltage	$V_{GE} = 15\text{V}$ $I_C = 300\text{A}$	$T_j = 25^\circ\text{C}$	1.4	1.8	V
			$T_j = 150^\circ\text{C}$	1.5		
$V_{GE(th)}$	Gate Threshold Voltage	$V_{GE} = V_{CE}, I_C = 1.5\text{ mA}$	5.0	5.8	6.5	V
I_{GES}	Gate – Emitter Leakage Current	$V_{GE} = 20\text{V}, V_{CE} = 0\text{V}$			500	nA

Dynamic Characteristics

Symbol	Characteristic	Test Conditions	Min	Typ	Max	Unit
C_{ies}	Input Capacitance	$V_{GE} = 0\text{V}$		24		nF
C_{oes}	Output Capacitance	$V_{CE} = 25\text{V}$		1.5		
C_{res}	Reverse Transfer Capacitance	$f = 1\text{MHz}$		0.75		
$T_{d(on)}$	Turn-on Delay Time	Inductive Switching (25°C)		115		ns
T_r	Rise Time	$V_{GE} = \pm 15\text{V}$		45		
$T_{d(off)}$	Turn-off Delay Time	$V_{Bus} = 300\text{V}$		200		
T_f	Fall Time	$I_C = 300\text{A}$ $R_G = 1.8\Omega$		55		
$T_{d(on)}$	Turn-on Delay Time	Inductive Switching (150°C)		120		ns
T_r	Rise Time	$V_{GE} = \pm 15\text{V}$		50		
$T_{d(off)}$	Turn-off Delay Time	$V_{Bus} = 300\text{V}$		250		
T_f	Fall Time	$I_C = 300\text{A}$ $R_G = 1.8\Omega$		70		
E_{on}	Turn on Energy	$V_{GE} = \pm 15\text{V}$ $V_{Bus} = 300\text{V}$	$T_j = 25^\circ\text{C}$	1.5		mJ
			$T_j = 150^\circ\text{C}$	2.7		
E_{off}	Turn off Energy	$I_C = 300\text{A}$ $R_G = 1.8\Omega$	$T_j = 25^\circ\text{C}$	8.55		mJ
			$T_j = 150^\circ\text{C}$	10.5		

Reverse diode ratings and characteristics

Symbol	Characteristic	Test Conditions	Min	Typ	Max	Unit
V_{RRM}	Maximum Peak Repetitive Reverse Voltage		600			V
I_{RM}	Maximum Reverse Leakage Current	$V_R = 600\text{V}$	$T_j = 25^\circ\text{C}$		150	μA
			$T_j = 150^\circ\text{C}$		400	
I_F	DC Forward Current			300		A
V_F	Diode Forward Voltage	$I_F = 300\text{A}$ $V_{GE} = 0\text{V}$	$T_j = 25^\circ\text{C}$	1.5	1.9	V
			$T_j = 150^\circ\text{C}$	1.4		
t_{rr}	Reverse Recovery Time		$T_j = 25^\circ\text{C}$	130		ns
			$T_j = 150^\circ\text{C}$	225		
Q_{rr}	Reverse Recovery Charge	$I_F = 300\text{A}$ $V_R = 300\text{V}$ $di/dt = 3100\text{A}/\mu\text{s}$	$T_j = 25^\circ\text{C}$	13.5		μC
			$T_j = 150^\circ\text{C}$	28.5		
E_r	Reverse Recovery Energy		$T_j = 25^\circ\text{C}$	3.5		mJ
			$T_j = 150^\circ\text{C}$	7.1		

Typical Performance Curve

www.datasheet4u.com

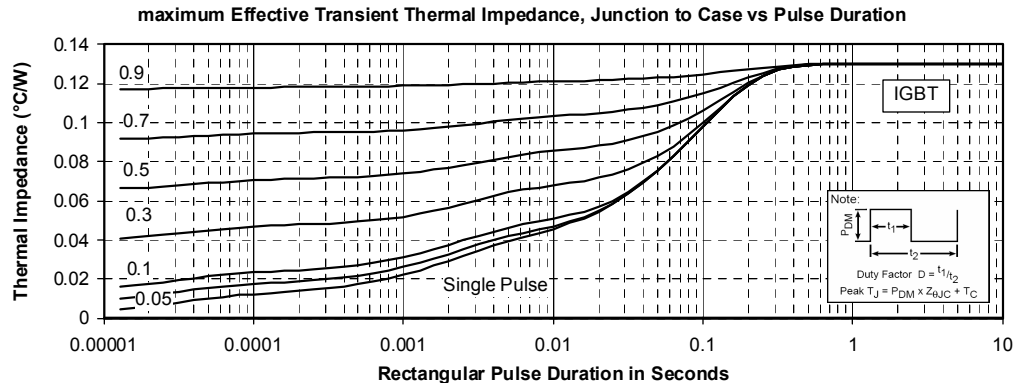
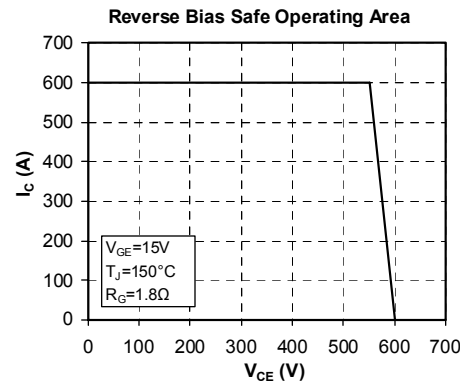
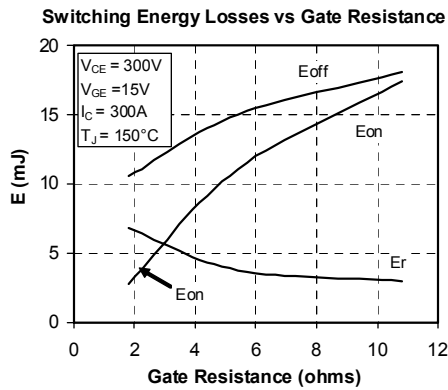
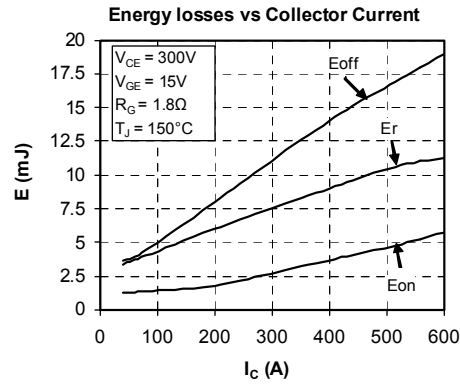
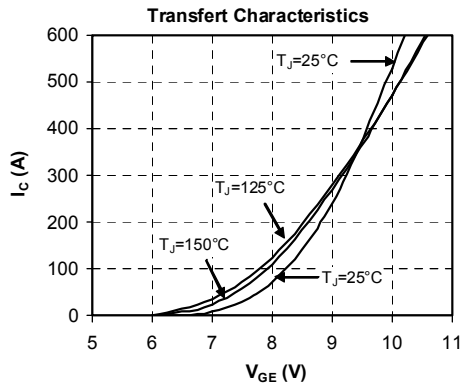
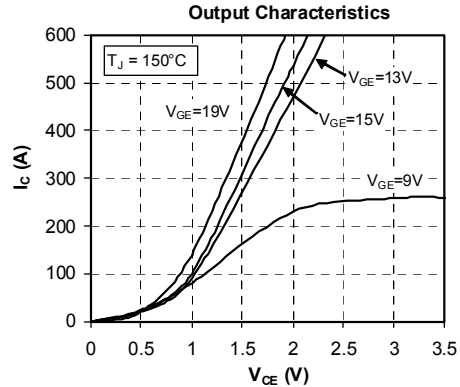
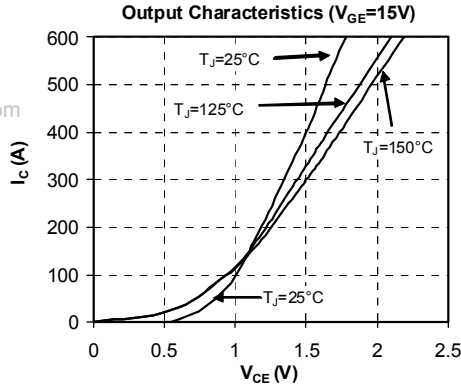

www.datasheet4u.com

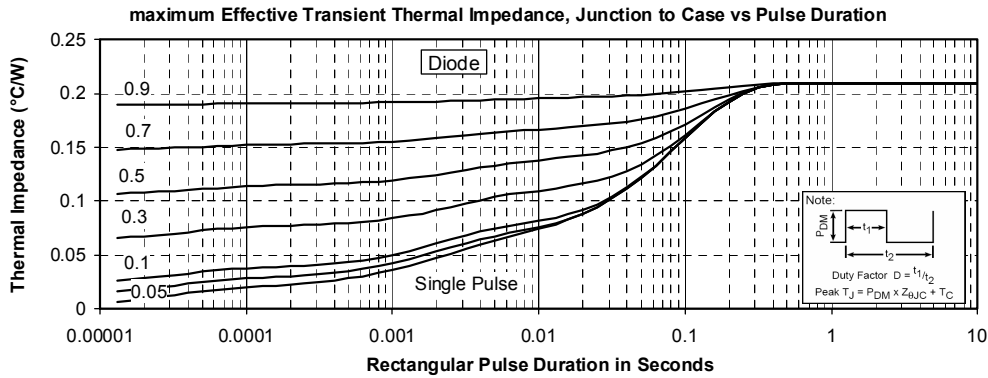
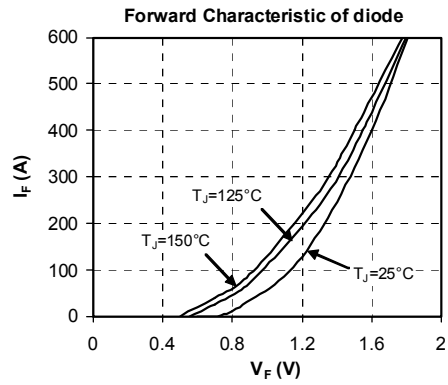
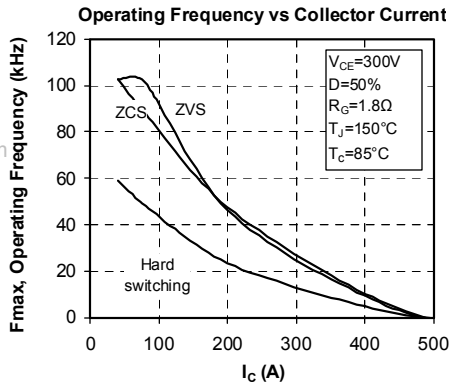

Microsemi reserves the right to change, without notice, the specifications and information contained herein

Microsemi's products are covered by one or more of U.S. patents 4,895,810 5,045,903 5,089,434 5,182,234 5,019,522 5,262,336 6,503,786 5,256,583 4,748,103 5,283,202 5,231,474 5,434,095 5,528,058 and foreign patents. U.S. and Foreign patents pending. All Rights Reserved.