

Phase leg
Intelligent Power Module

www.DataSheet4U.net

$V_{CES} = 1200V$
 $I_C = 325A @ T_c = 80^{\circ}C$

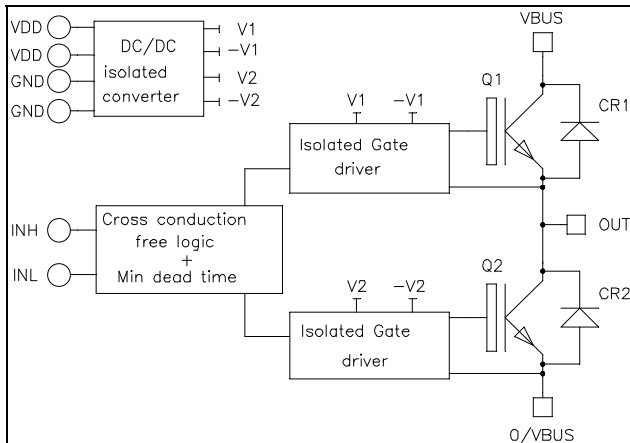

Application

- Motor control
- Uninterruptible Power Supplies
- Switched Mode Power Supplies
- Amplifier

Features

- **Trench + Field Stop IGBT 4 Technology**
 - Low voltage drop
 - Low leakage current
 - Low switching losses
 - Soft recovery parallel diodes
 - Low diode VF
 - RBSOA and SCSOA rated
- **Integrated Fail Safe IGBT Protection (Driver)**
 - Top Bottom input signals Interlock
 - Isolated DC/DC Converter

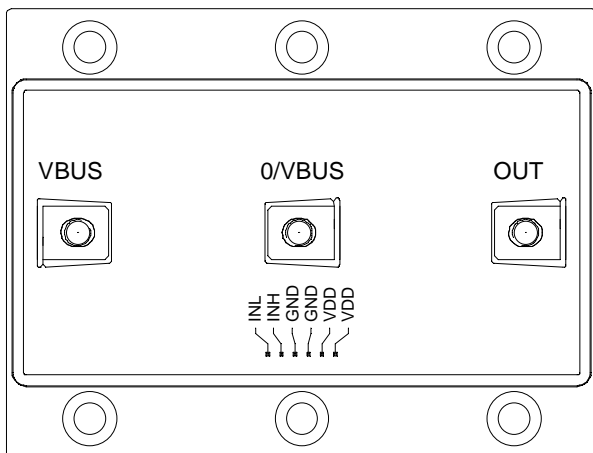

- Low stray inductance
- M5 power connectors
- High level of integration

Benefits

- Outstanding performance at high frequency operation
- Stable temperature behavior
- Very rugged
- Direct mounting to heatsink (isolated package)
- Low junction to case thermal resistance
- Very high noise immunity (common mode rejection > 25kV/μs)
- Galvanic Isolation: 3750V for the optocoupler
2500V for the transformer
- 5V logic level with Schmitt-trigger Input
- Single V_{DD}=5V supply required
- Secondary auxiliary power supplies internally generated (15V, -6V)
- Optocoupler qualified to AEC-Q100 test guidelines
- RoHS compliant

CAUTION: These Devices are sensitive to Electrostatic Discharge. Proper Handling Procedures Should Be Followed.
See application note APT0502 on www.microsemi.com

All ratings @ $T_j = 25^\circ\text{C}$ unless otherwise specified

1. Inverter Power Module
Absolute maximum ratings

Symbol	Parameter	Max ratings	Unit
V_{CES}	Collector - Emitter Breakdown Voltage	1200	V
I_C	Continuous Collector Current	$T_C = 25^\circ\text{C}$	420
		$T_C = 80^\circ\text{C}$	325
I_{CM}	Pulsed Collector Current	$T_C = 25^\circ\text{C}$	600
P_D	Maximum Power Dissipation	$T_C = 25^\circ\text{C}$	1500
RBSOA	Reverse Bias Safe Operating Area	$T_j = 150^\circ\text{C}$	600A @ 1150V

Electrical Characteristics

Symbol	Characteristic	Test Conditions	Min	Typ	Max	Unit
I_{CES}	Zero Gate Voltage Collector Current	$V_{GE} = 0\text{V}$ $V_{CE} = 1200\text{V}$	$T_j = 25^\circ\text{C}$		500	μA
			$T_j = 150^\circ\text{C}$		750	
$V_{CE(sat)}$	Collector Emitter Saturation Voltage	$V_{DD} = V_{IN} = 5\text{V}$ $I_C = 300\text{A}$	$T_j = 25^\circ\text{C}$	1.85	2.2	V
			$T_j = 150^\circ\text{C}$	2.2		

Dynamic Characteristics

Symbol	Characteristic	Test Conditions	Min	Typ	Max	Unit
C_{ies}	Input Capacitance	$V_{GE} = 0\text{V}$ $V_{CE} = 25\text{V}$ $f = 1\text{MHz}$		17.6		nF
C_{oes}	Output Capacitance			1.16		
C_{res}	Reverse Transfer Capacitance			0.94		
T_r	Rise Time	Inductive Switching (25°C) $V_{DD} = V_{IN} = 5\text{V}$ $V_{Bus} = 600\text{V}; I_C = 300\text{A}$		30		ns
T_f	Fall Time			70		
T_r	Rise Time	Inductive Switching (150°C) $V_{DD} = V_{IN} = 5\text{V}$ $V_{Bus} = 600\text{V}$ $I_C = 300\text{A}$		40		ns
T_f	Fall Time			80		
E_{on}	Turn-on Switching Energy	$V_{DD} = V_{IN} = 5\text{V}; V_{Bus} = 900\text{V}$ $t_p \leq 10\mu\text{s}; T_j = 150^\circ\text{C}$		34		mJ
E_{off}	Turn-off Switching Energy			29		
I_{sc}	Short Circuit data			1100		A
R_{thJC}	Junction to Case thermal resistance				0.1	$^\circ\text{C}/\text{W}$

Reverse diode ratings and characteristics

Symbol	Characteristic	Test Conditions	Min	Typ	Max	Unit
V _{RRM}	Maximum Peak Repetitive Reverse Voltage		1200			V
I _{RM}	Maximum Reverse Leakage Current	V _R =1200V			250	μA
					750	
I _F	DC Forward Current			360		A
V _F	Diode Forward Voltage	I _F = 300A		1.7	2.2	V
				1.65		
t _{rr}	Reverse Recovery Time			155		ns
				300		
Q _{rr}	Reverse Recovery Charge	I _F = 300A V _R = 600V di/dt = 7000A/μs		29		μC
				61		
E _{rr}	Reverse Recovery Energy			10.4		mJ
				22		
R _{thJC}	Junction to Case Thermal Resistance				0.17	°C/W

2. Driver
Absolute maximum ratings

Symbol	Parameter	Max ratings	Unit
V _{DD}	Supply Voltage	5.5	V
V _{INi}	Input signal voltage i=L, H	5.5	V
I _{VDDmax}	Maximum Supply current	0.35	A
	V _{INi} = 0V, i = L & H		
	V _{DD} =5V, V _{INH} = /V _{INL} ; F _{out} = 55kHz	2	
f _{max}	Maximum Switching Frequency	55	kHz

Driver Electrical Characteristics

Symbol	Characteristic	Test Conditions	Min	Typ	Max	Unit
V _{DD}	Operating Supply Voltage		4.5	5	5.5	V
V _{INi(max)}	Maximum Input Voltage		-0.5	5	5.5	V
V _{INi(th+)}	Positive Going Threshold Voltage	i = L, H		3.2		V
V _{INi(th-)}	Negative Going Threshold Voltage			1		V
R _{INi}	Input Resistance *			1		kΩ
T _{d(on)}	Turn On delay time	Driver + IGBT		1100 ^❶		ns
D _T	Built in dead time			600		ns
T _{d(off)}	Turn Off delay time	Driver + IGBT		750		ns
PWD	Pulse Width Distortion				300	ns
PDD	Propagation Delay Difference between any two driver	T _{d(on)} - T _{d(off)}	-350		350	ns
V _{ISOL}	Primary to Secondary Isolation		2500			V _{RMS}

* Low impedance guarantees good noise immunity.

❶ Including built in dead time.

3. Package characteristics

Symbol	Characteristic	Min	Typ	Max	Unit	
V _{ISOL}	RMS Isolation Voltage, any terminal to case t=1 min, I isol<1mA, 50/60Hz	2500			V	
T _J	Operating junction temperature range	-40		150	°C	
T _{OP}	Operating Ambient Temperature	-40		85		
T _{STG}	Storage Temperature Range	-40		100		
T _C	Operating Case Temperature	-40		100		
Torque	Mounting torque	To heatsink	M5	2	4.7	N.m
		For terminals	M5	2	4	
Wt	Package Weight		550		g	

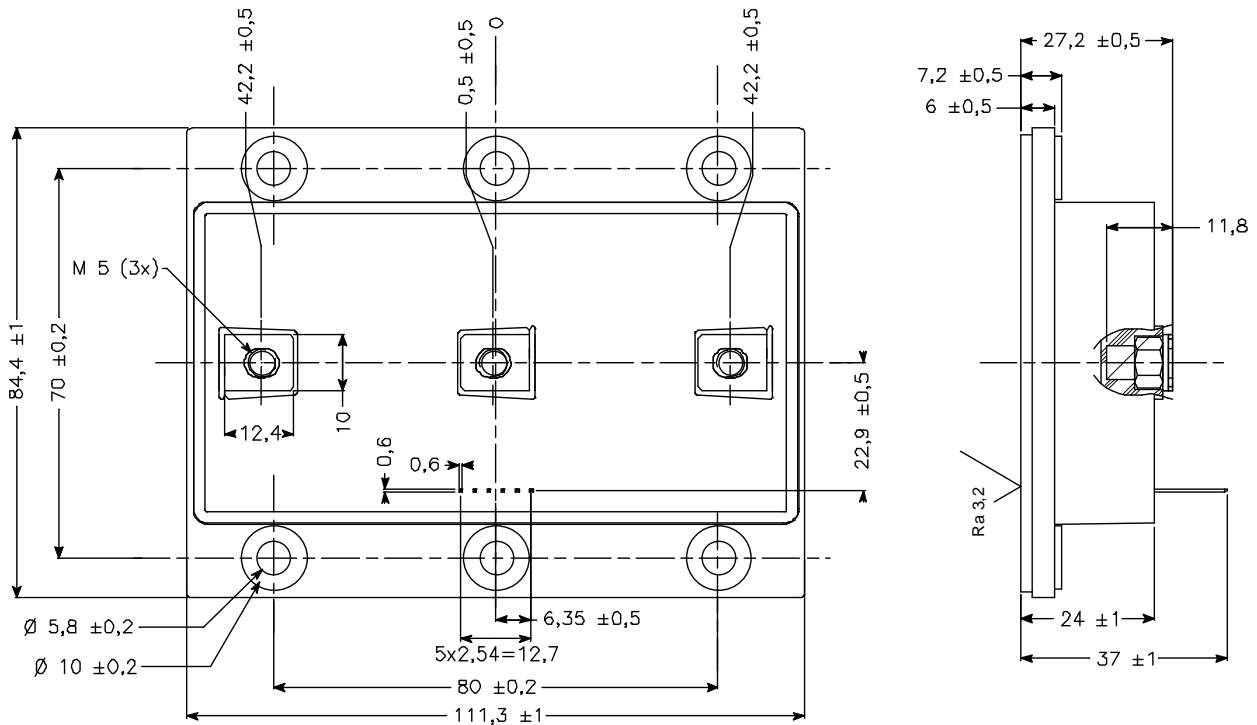
4. LP8 Package outline (dimensions in mm)

Typical IGBT Performance Curve

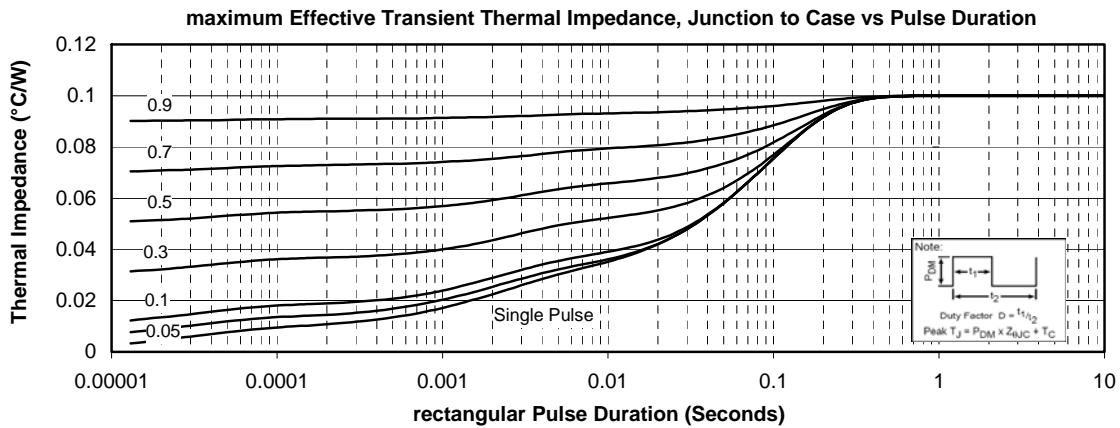
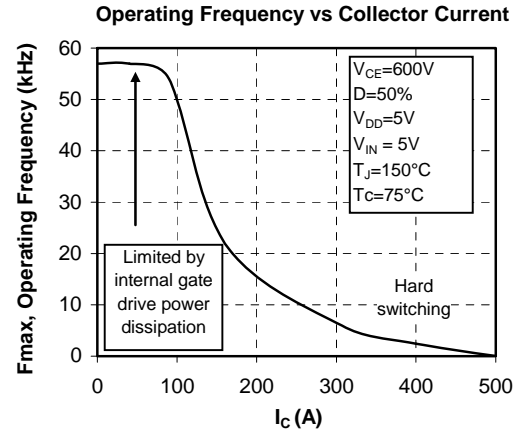
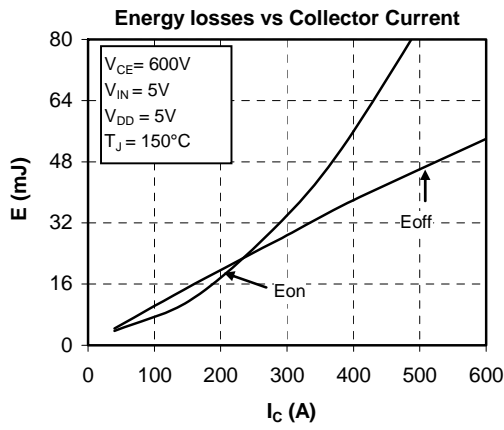
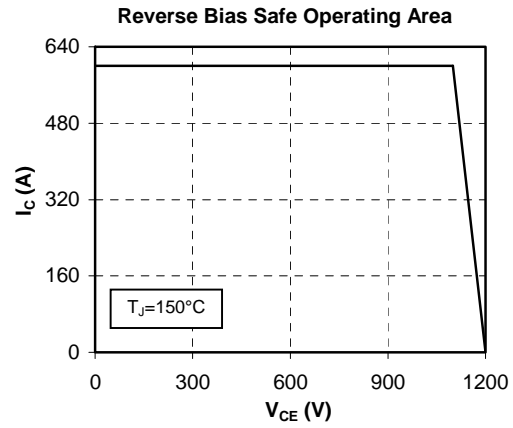
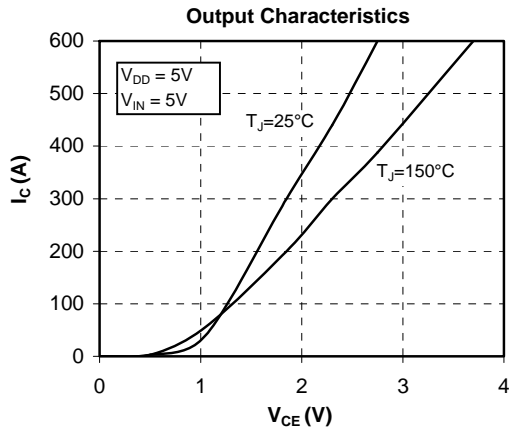

Typical diode Performance Curve

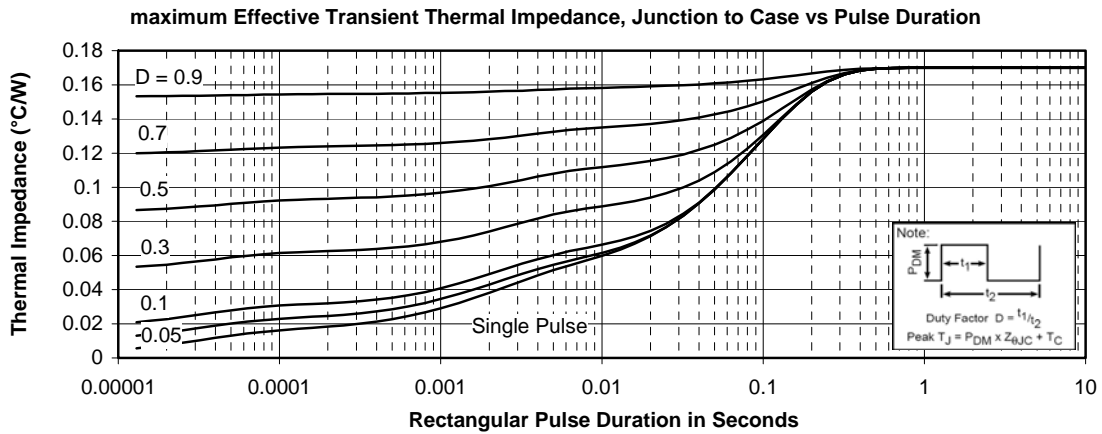
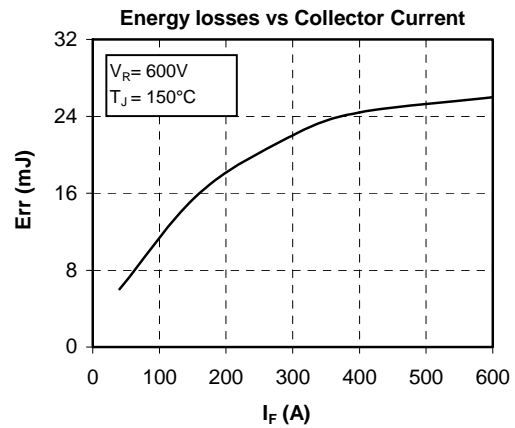
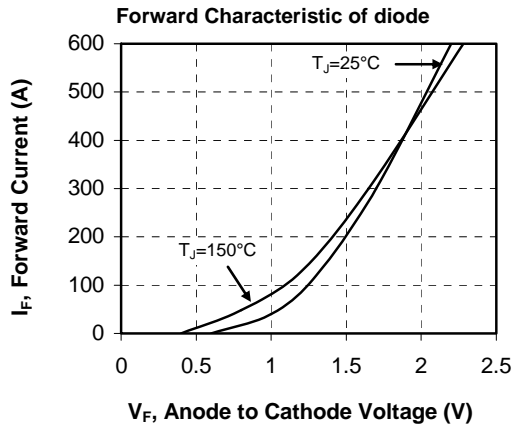

Microsemi reserves the right to change, without notice, the specifications and information contained herein