

**Triple dual common source  
MOSFET Power Module**

**$V_{DSS} = 75V$   
 $R_{DSon} = 04m\Omega \text{ max @ } T_j = 25^\circ C$   
 $I_D = 120A \text{ @ } T_c = 25^\circ C$**

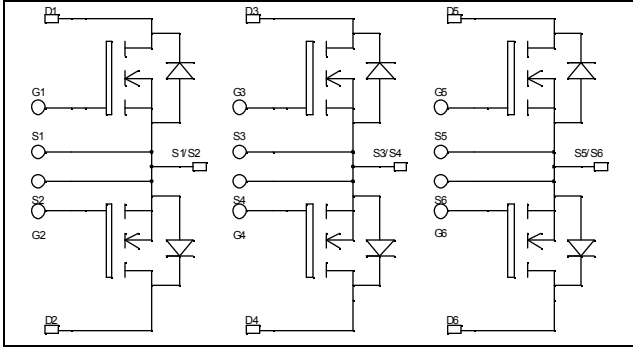

**Application**

- AC Switches
- Switched Mode Power Supplies
- Uninterruptible Power Supplies

**Features**

- Power MOSFETs
  - Low  $R_{DSon}$
  - Low input and Miller capacitance
  - Low gate charge
  - Avalanche energy rated
  - Very rugged
- Kelvin source for easy drive
- Very low stray inductance
  - Symmetrical design
  - Lead frames for power connections
- High level of integration

**Benefits**

- Outstanding performance at high frequency operation
- Direct mounting to heatsink (isolated package)
- Low junction to case thermal resistance
- Solderable terminals both for power and signal for easy PCB mounting
- Very low (12mm) profile
- Each leg can be easily paralleled to achieve a phase leg of three times the current capability

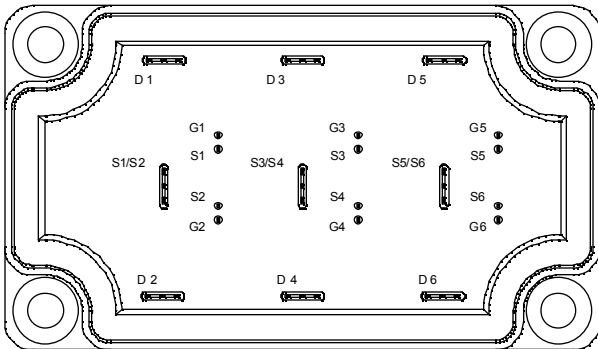

**Absolute maximum ratings**

Symbol	Parameter	Max ratings	Unit
$V_{DSS}$	Drain - Source Breakdown Voltage	75	V
$I_D$	Continuous Drain Current	$T_c = 25^\circ C$	120
		$T_c = 80^\circ C$	90
$I_{DM}$	Pulsed Drain current	250	A
$V_{GS}$	Gate - Source Voltage	$\pm 30$	V
$R_{DSon}$	Drain - Source ON Resistance	04	$m\Omega$
$P_D$	Maximum Power Dissipation	$T_c = 25^\circ C$	138
$I_{AR}$	Avalanche current (repetitive and non repetitive)	75	A
$E_{AR}$	Repetitive Avalanche Energy	50	mJ
$E_{AS}$	Single Pulse Avalanche Energy	1500	

**CAUTION:** These Devices are sensitive to Electrostatic Discharge. Proper Handling Procedures Should Be Followed.

All ratings @  $T_j = 25^\circ\text{C}$  unless otherwise specified

**Electrical Characteristics**

Symbol	Characteristic	Test Conditions	Min	Typ	Max	Unit
$BV_{DSS}$	Drain - Source Breakdown Voltage	$V_{GS} = 0V, I_D = 1mA$	75			V
$I_{DSS}$	Zero Gate Voltage Drain Current	$V_{GS} = 0V, V_{DS} = 75V$   $T_j = 25^\circ\text{C}$			100	$\mu\text{A}$
		$V_{GS} = 0V, V_{DS} = 60V$   $T_j = 125^\circ\text{C}$			250	
$R_{DS(on)}$	Drain - Source on Resistance	$V_{GS} = 10V, I_D = 60A$			04	$\text{m}\Omega$
$V_{GS(th)}$	Gate Threshold Voltage	$V_{GS} = V_{DS}, I_D = 1mA$	2		4	V
$I_{GSS}$	Gate - Source Leakage Current	$V_{GS} = \pm 30V, V_{DS} = 0V$			$\pm 100$	nA

**Dynamic Characteristics**

Symbol	Characteristic	Test Conditions	Min	Typ	Max	Unit
$C_{iss}$	Input Capacitance	$V_{GS} = 0V$ $V_{DS} = 25V$ $f = 1MHz$		4530		pF
$C_{oss}$	Output Capacitance			1080		
$C_{rss}$	Reverse Transfer Capacitance			450		
$Q_g$	Total gate Charge	$V_{GS} = 10V$ $V_{Bus} = 60V$ $I_D = 120A$		153		nC
$Q_{gs}$	Gate - Source Charge			25		
$Q_{gd}$	Gate - Drain Charge			82		
$T_{d(on)}$	Turn-on Delay Time	<b>Inductive switching @ <math>125^\circ\text{C}</math></b> $V_{GS} = 15V$ $V_{Bus} = 40V$ $I_D = 120A$ $R_G = 5\Omega$		35		ns
$T_r$	Rise Time			60		
$T_{d(off)}$	Turn-off Delay Time			100		
$T_f$	Fall Time			65		
$E_{on}$	Turn-on Switching Energy ❶	<b>Inductive switching @ <math>25^\circ\text{C}</math></b> $V_{GS} = 15V, V_{Bus} = 40V$ $I_D = 120A, R_G = 5\Omega$		290		$\mu\text{J}$
$E_{off}$	Turn-off Switching Energy ❷			317		
$E_{on}$	Turn-on Switching Energy ❶	<b>Inductive switching @ <math>125^\circ\text{C}</math></b> $V_{GS} = 15V, V_{Bus} = 40V$ $I_D = 120A, R_G = 5\Omega$		319		$\mu\text{J}$
$E_{off}$	Turn-off Switching Energy ❷			336		

**Source - Drain diode ratings and characteristics**

Symbol	Characteristic	Test Conditions	Min	Typ	Max	Unit	
$I_S$	Continuous Source current (Body diode)		$T_c = 25^\circ\text{C}$		120	A	
			$T_c = 80^\circ\text{C}$		90		
$V_{SD}$	Diode Forward Voltage	$V_{GS} = 0V, I_S = -120A$			1.3	V	
$dv/dt$	Peak Diode Recovery ❸				6	V/ns	
$t_{rr}$	Reverse Recovery Time	$I_S = -120A$ $V_R = 40V$	$T_j = 25^\circ\text{C}$		100	200	ns
$Q_{rr}$	Reverse Recovery Charge	$di/dt = 100A/\mu\text{s}$	$T_j = 25^\circ\text{C}$		300		nC

❶  $E_{on}$  includes diode reverse recovery.

❷ In accordance with JEDEC standard JESD24-1.

❸  $dv/dt$  numbers reflect the limitations of the circuit rather than the device itself.

$$I_S \leq -120A \quad di/dt \leq 700A/\mu\text{s} \quad V_R \leq V_{DSS} \quad T_j \leq 150^\circ\text{C}$$

**Thermal and package characteristics**

Symbol	Characteristic		Min	Typ	Max	Unit
R <sub>thJC</sub>	Junction to Case	IGBT			0.9	°C/W
V <sub>ISOL</sub>	RMS Isolation Voltage, any terminal to case t=1 min, I isol<1mA, 50/60Hz		2500			V
T <sub>J</sub>	Operating junction temperature range		-40		150	°C
T <sub>STG</sub>	Storage Temperature Range		-40		125	
T <sub>C</sub>	Operating Case Temperature		-40		100	
Torque	Mounting torque	To heatsink	M6	3	5	N.m
Wt	Package Weight				250	g

**Package outline**

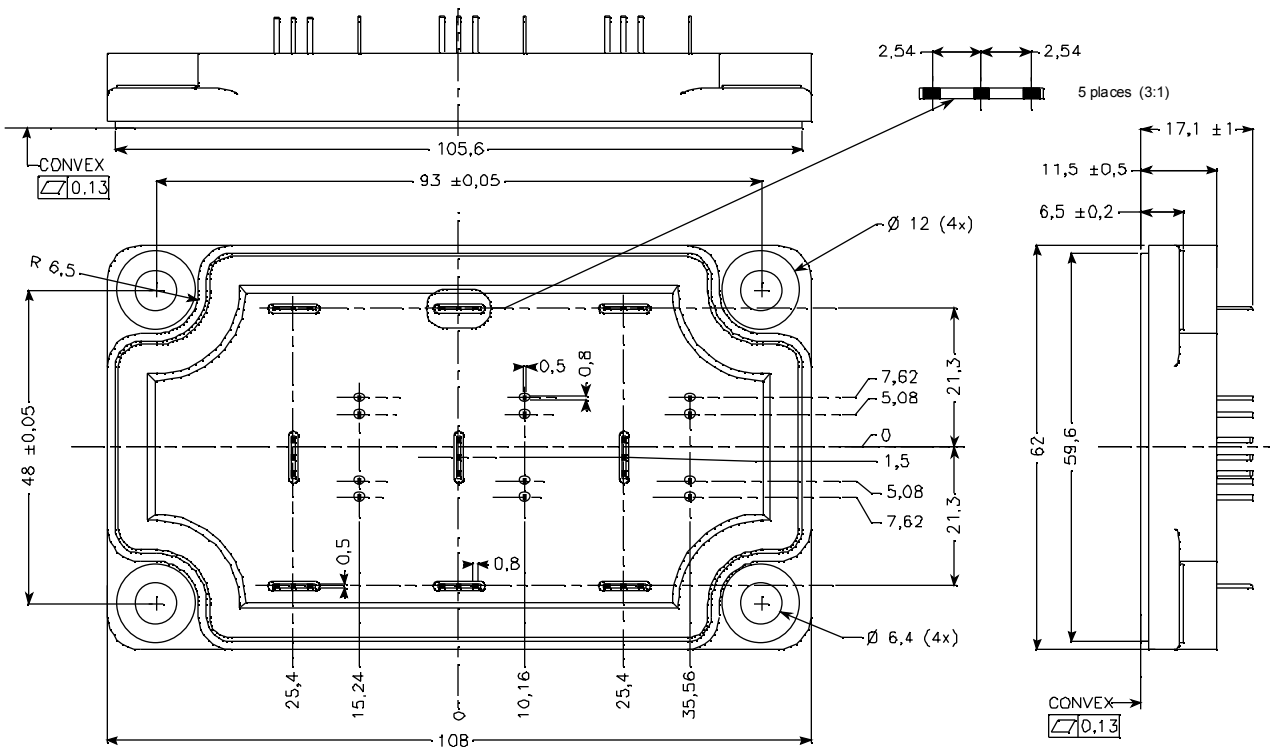

**Typical Performance Curve**

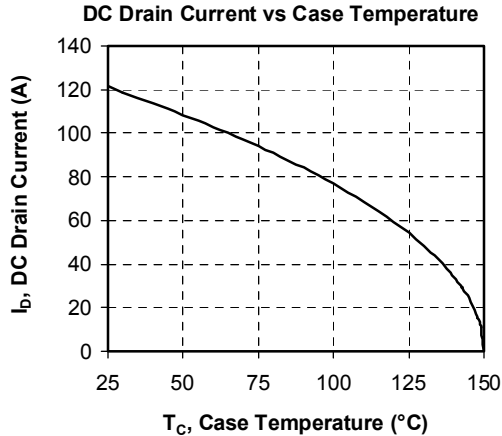
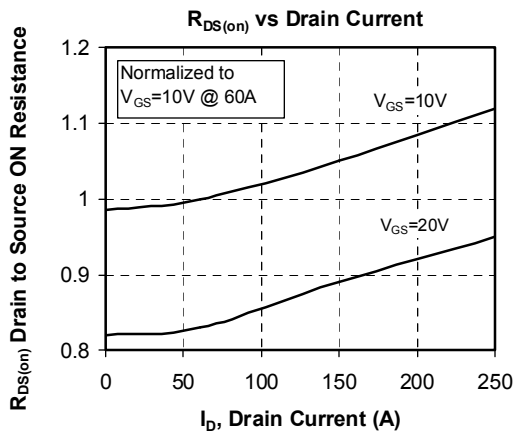
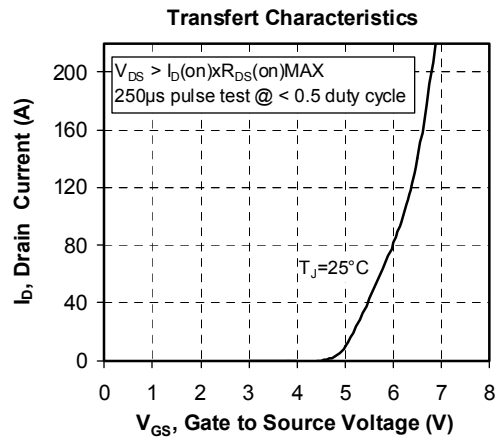
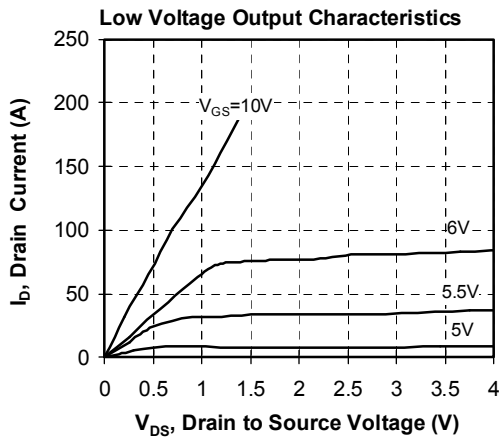
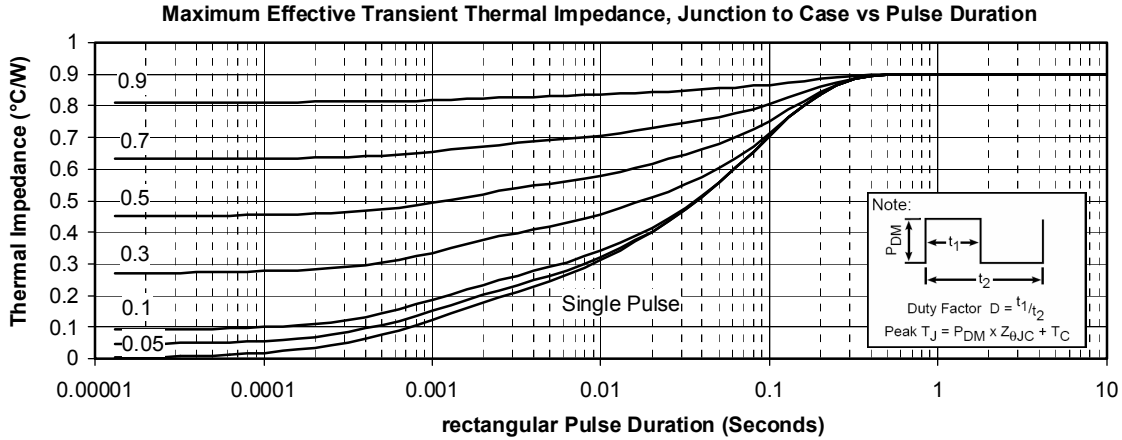

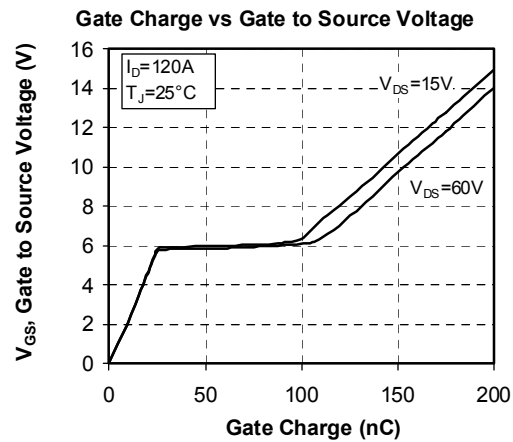
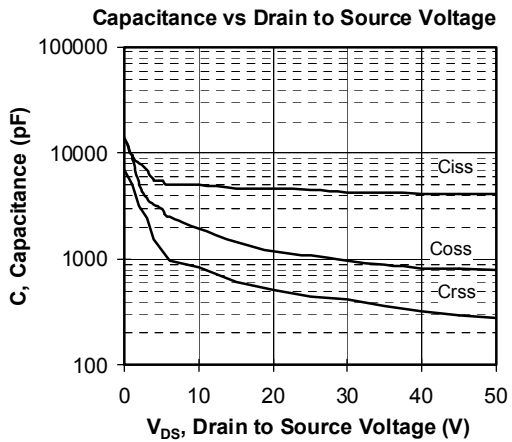
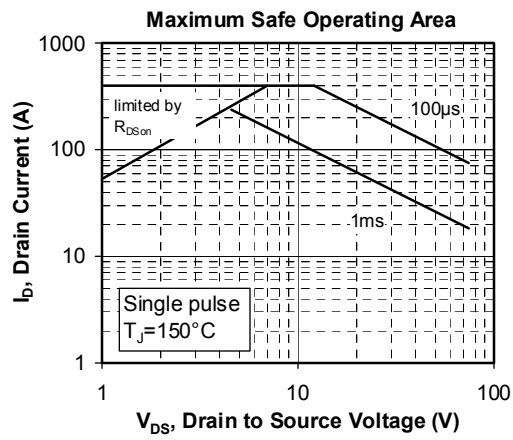
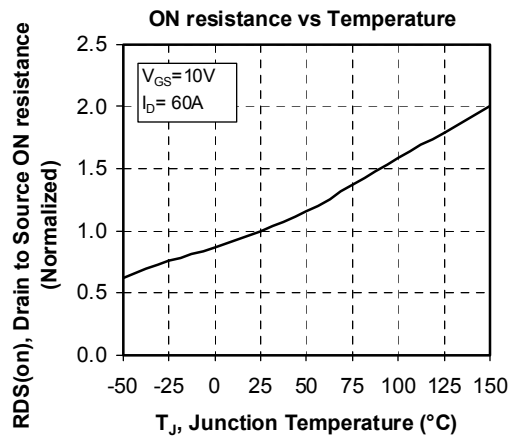

**Delay Times vs Current**

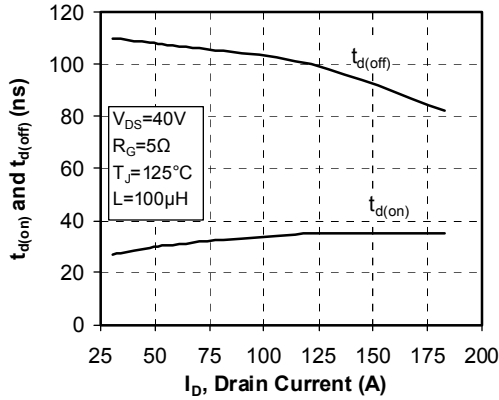

**Rise and Fall times vs Current**

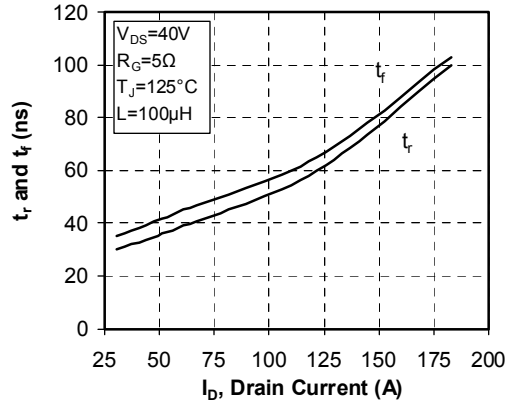

**Switching Energy vs Current**

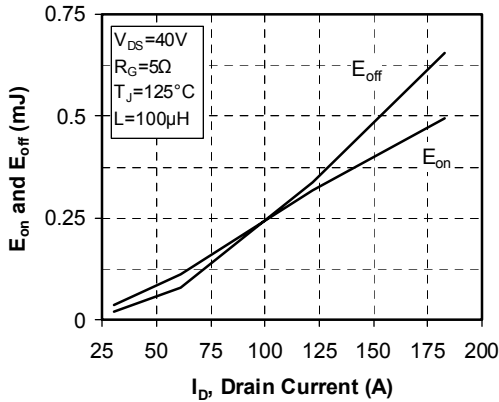

**Switching Energy vs Gate Resistance**

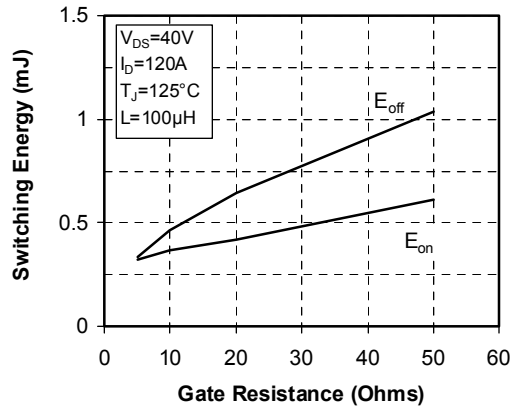

**Operating Frequency vs Drain Current**

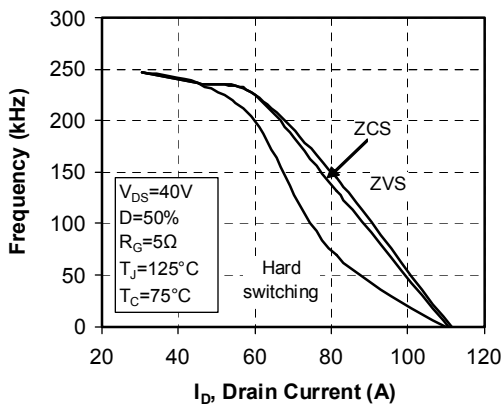

**Source to Drain Diode Forward Voltage**

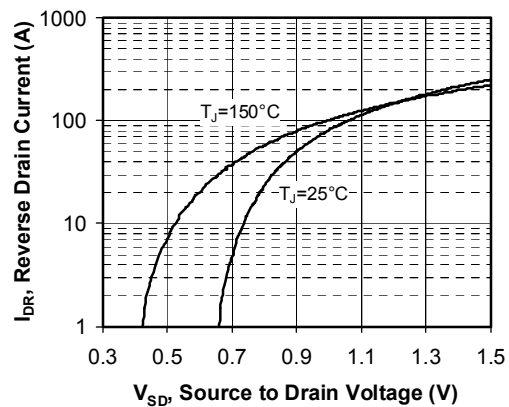

APT reserves the right to change, without notice, the specifications and information contained herein

APT's products are covered by one or more of U.S. patents 4,895,810 5,045,903 5,089,434 5,182,234 5,019,522 5,262,336 6,503,786 5,256,583 4,748,103 5,283,202 5,231,474 5,434,095 5,528,058 and foreign patents. U.S. and Foreign patents pending. All Rights Reserved.