

**Dual Buck chopper
MOSFET Power Module**

**$V_{DSS} = 100V$
 $R_{DSon} = 9m\Omega$ typ @ $T_j = 25^\circ C$
 $I_D = 139A$ @ $T_c = 25^\circ C$**

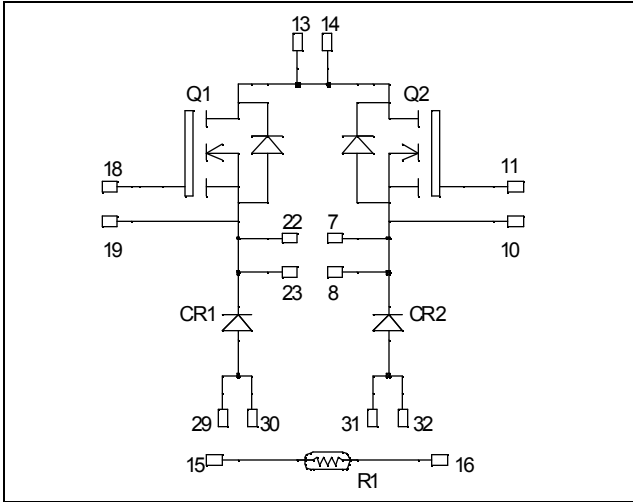

Application

- AC and DC motor control
- Switched Mode Power Supplies

Features

- Power MOS V[®] MOSFETs
 - Low R_{DSon}
 - Low input and Miller capacitance
 - Low gate charge
 - Avalanche energy rated
 - Very rugged
- Kelvin source for easy drive
- Very low stray inductance
 - Symmetrical design
- Internal thermistor for temperature monitoring
- High level of integration

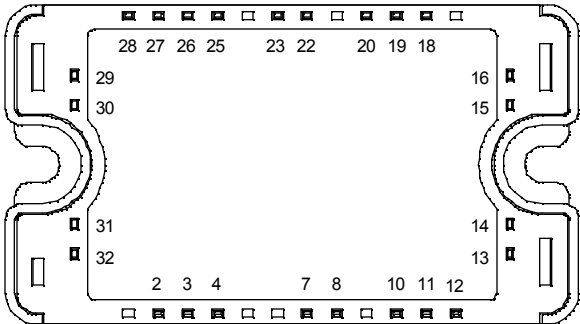

Benefits

- Outstanding performance at high frequency operation
- Direct mounting to heatsink (isolated package)
- Low junction to case thermal resistance
- Solderable terminals both for power and signal for easy PCB mounting
- Low profile
- Each leg can be easily paralleled to achieve a single buck of twice the current capability

All multiple inputs and outputs must be shorted together
Example: 13/14 ; 29/30 ; 22/23 ...

Absolute maximum ratings

Symbol	Parameter	Max ratings	Unit
V_{DSS}	Drain - Source Breakdown Voltage	100	V
I_D	Continuous Drain Current	$T_c = 25^\circ C$	139
		$T_c = 80^\circ C$	100 *
I_{DM}	Pulsed Drain current	430	A
V_{GS}	Gate - Source Voltage	± 30	V
R_{DSon}	Drain - Source ON Resistance	9.5	$m\Omega$
P_D	Maximum Power Dissipation	$T_c = 25^\circ C$	390
I_{AR}	Avalanche current (repetitive and non repetitive)	100	A
E_{AR}	Repetitive Avalanche Energy	50	mJ
E_{AS}	Single Pulse Avalanche Energy	3000	

* Specification of MOSFET device but output current must be limited to 75A to not exceed a delta of temperature greater than 30°C for the connectors.

CAUTION: These Devices are sensitive to Electrostatic Discharge. Proper Handling Procedures Should Be Followed.

All ratings @ $T_j = 25^\circ\text{C}$ unless otherwise specified

Electrical Characteristics

Symbol	Characteristic	Test Conditions	Min	Typ	Max	Unit
I_{DSS}	Zero Gate Voltage Drain Current	$V_{GS} = 0V, V_{DS} = 100V$			100	μA
		$V_{GS} = 0V, V_{DS} = 80V$			500	
$R_{DS(on)}$	Drain – Source on Resistance	$V_{GS} = 10V, I_D = 69.5A$		9	9.5	$\text{m}\Omega$
$V_{GS(th)}$	Gate Threshold Voltage	$V_{GS} = V_{DS}, I_D = 2.5\text{mA}$	2		4	V
I_{GSS}	Gate – Source Leakage Current	$V_{GS} = \pm 30V, V_{DS} = 0V$			± 100	nA

Dynamic Characteristics

Symbol	Characteristic	Test Conditions	Min	Typ	Max	Unit
C_{iss}	Input Capacitance	$V_{GS} = 0V$		9875		pF
C_{oss}	Output Capacitance	$V_{DS} = 25V$		3940		
C_{rss}	Reverse Transfer Capacitance	$f = 1\text{MHz}$		1470		
Q_g	Total gate Charge	$V_{GS} = 10V$ $V_{Bus} = 50V$ $I_D = 139A$		350		nC
Q_{gs}	Gate – Source Charge			60		
Q_{gd}	Gate – Drain Charge			180		
$T_{d(on)}$	Turn-on Delay Time	Inductive switching @ 125°C $V_{GS} = 15V$ $V_{Bus} = 66V$ $I_D = 139A$ $R_G = 5\Omega$		35		ns
T_r	Rise Time			70		
$T_{d(off)}$	Turn-off Delay Time			95		
T_f	Fall Time			125		
E_{on}	Turn-on Switching Energy ❶	Inductive switching @ 25°C $V_{GS} = 15V, V_{Bus} = 66V$ $I_D = 139A, R_G = 5\Omega$		552		μJ
E_{off}	Turn-off Switching Energy ❷			604		
E_{on}	Turn-on Switching Energy ❶	Inductive switching @ 125°C $V_{GS} = 15V, V_{Bus} = 66V$ $I_D = 139A, R_G = 5\Omega$		608		μJ
E_{off}	Turn-off Switching Energy ❷			641		

❶ E_{on} includes diode reverse recovery.

❷ In accordance with JEDEC standard JESD24-1.

Chopper diode ratings and characteristics

Symbol	Characteristic	Test Conditions	Min	Typ	Max	Unit
V_{RRM}	Maximum Peak Repetitive Reverse Voltage		200			V
I_{RM}	Maximum Reverse Leakage Current	$V_R = 200V$	$T_j = 25^\circ\text{C}$		250	μA
			$T_j = 125^\circ\text{C}$		500	
$I_{F(AV)}$	Maximum Average Forward Current	50% duty cycle		100		A
V_F	Diode Forward Voltage	$I_F = 100A$		1		V
		$I_F = 200A$		1.4		
		$I_F = 100A$	$T_j = 125^\circ\text{C}$		0.9	
t_{rr}	Reverse Recovery Time	$I_F = 100A$ $V_R = 133V$ $di/dt = 200A/\mu\text{s}$	$T_j = 25^\circ\text{C}$		60	ns
			$T_j = 125^\circ\text{C}$		110	
Q_{rr}	Reverse Recovery Charge	$I_F = 100A$ $V_R = 133V$ $di/dt = 200A/\mu\text{s}$	$T_j = 25^\circ\text{C}$		200	nC
			$T_j = 125^\circ\text{C}$		840	

Thermal and package characteristics

Symbol	Characteristic	Min	Typ	Max	Unit	
R _{thJC}	Junction to Case	IGBT		0.32	°C/W	
		Diode		0.55		
V _{ISOL}	RMS Isolation Voltage, any terminal to case t = 1 min, I _{isol} < 1mA, 50/60Hz	2500			V	
T _J	Operating junction temperature range	-40		150	°C	
T _{STG}	Storage Temperature Range	-40		125		
T _C	Operating Case Temperature	-40		100		
Torque	Mounting torque	To heatsink	M4	1.5	4.7	N.m
Wt	Package Weight				110	g

Temperature sensor NTC (for more information see application note APT0406 on www.advancedpower.com).

Symbol	Characteristic	Min	Typ	Max	Unit
R ₂₅	Resistance @ 25°C		50		kΩ
B _{25/85}	T ₂₅ = 298.15 K		3952		K

$$R_T = \frac{R_{25}}{\exp\left[B_{25/85}\left(\frac{1}{T_{25}} - \frac{1}{T}\right)\right]}$$

T: Thermistor temperature
R_T: Thermistor value at T

Package outline (dimensions in mm)

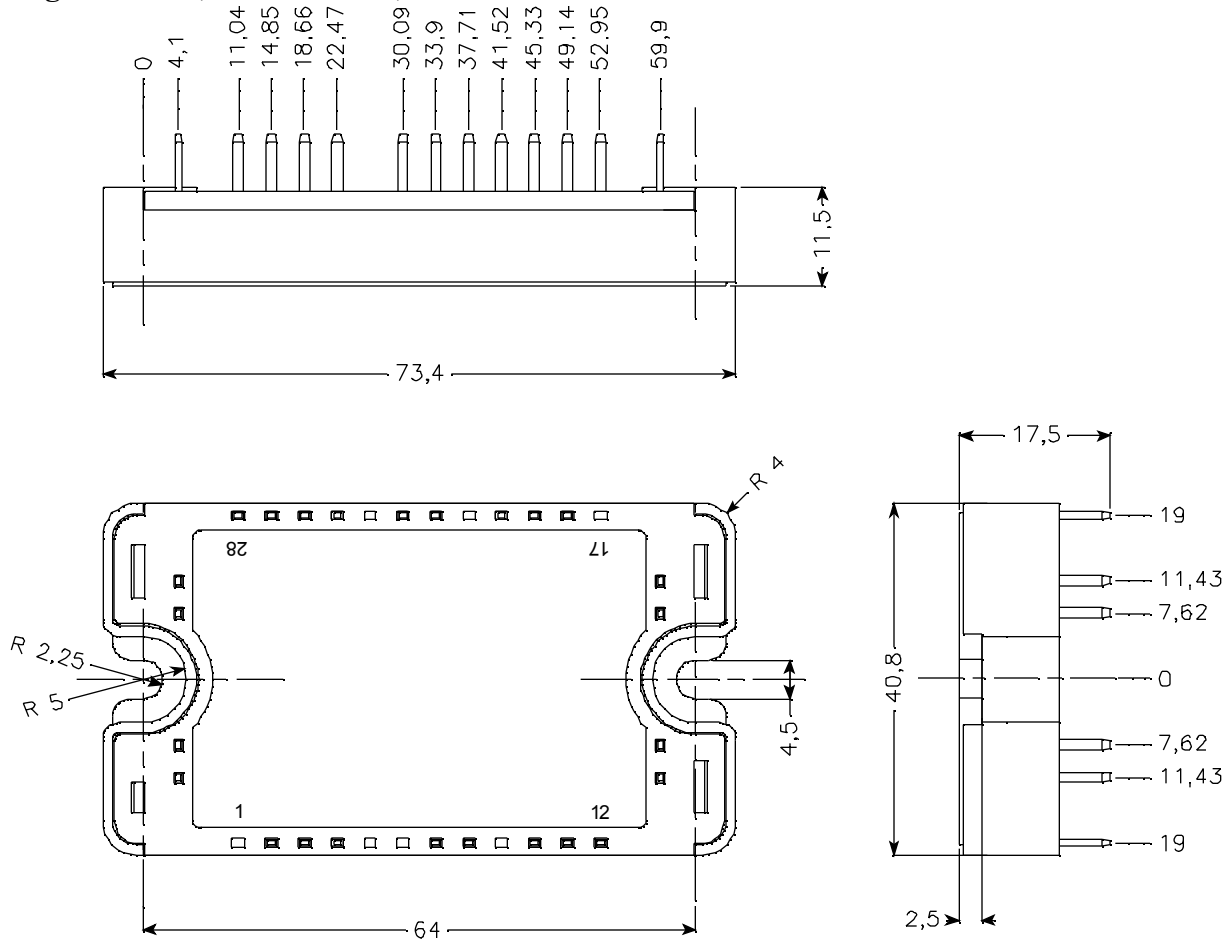

Typical Performance Curve

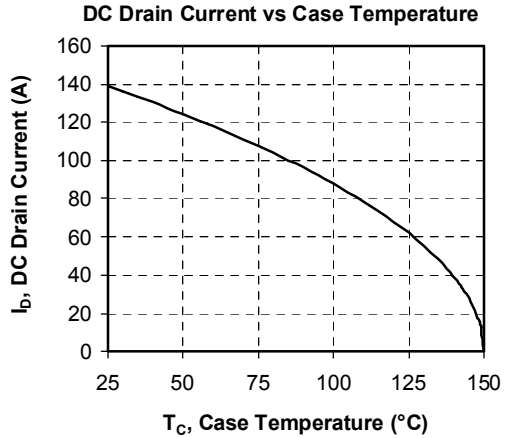
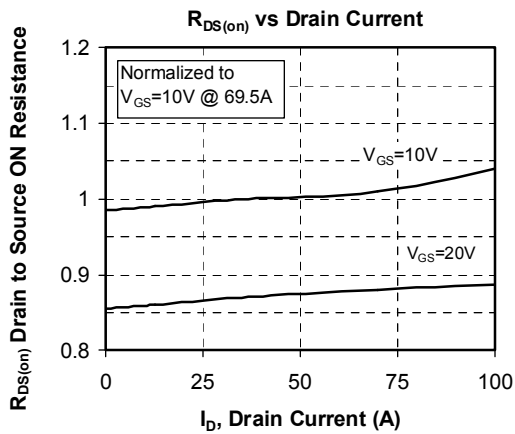
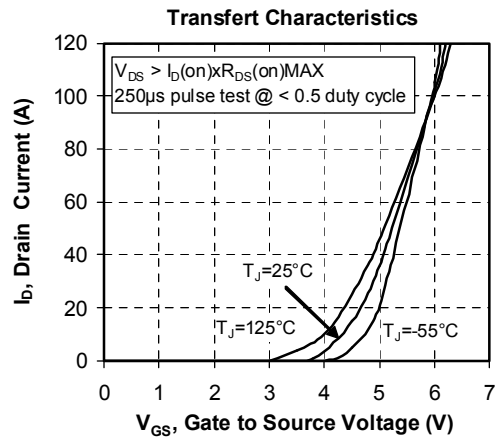
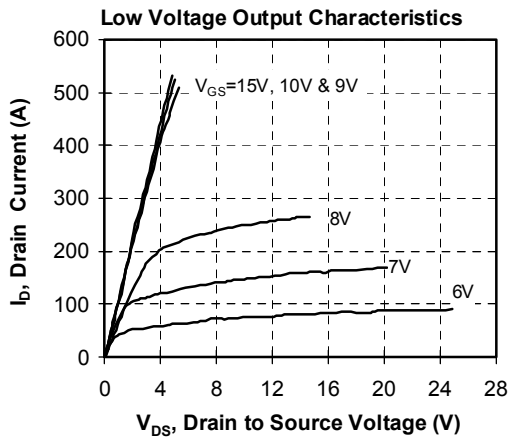
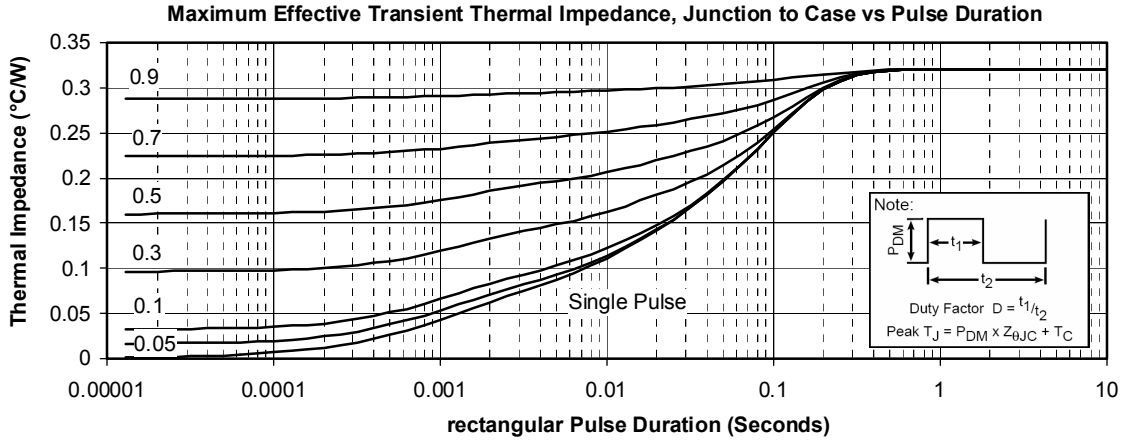

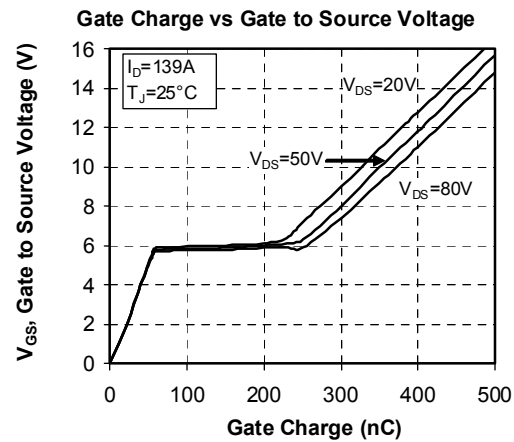
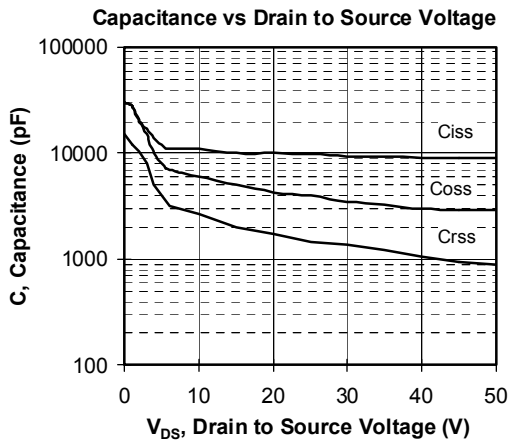
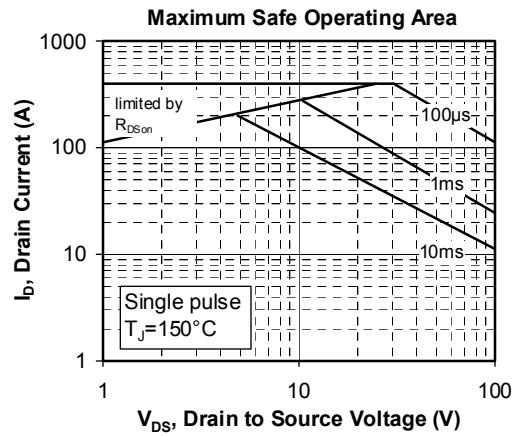
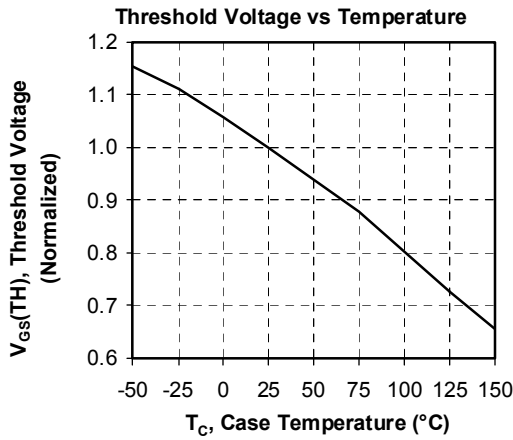
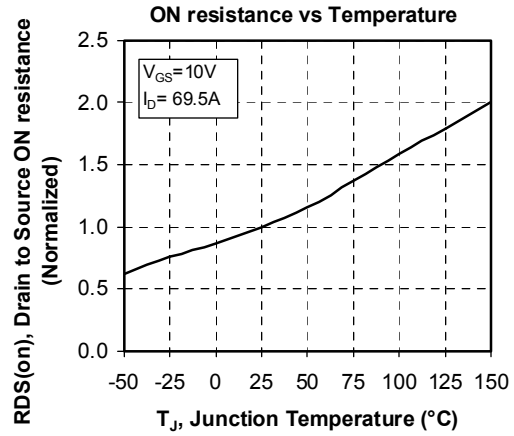
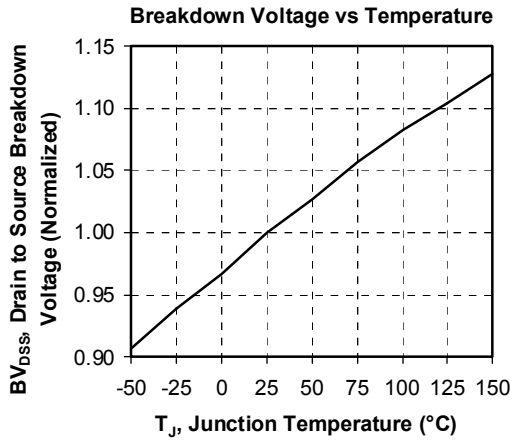

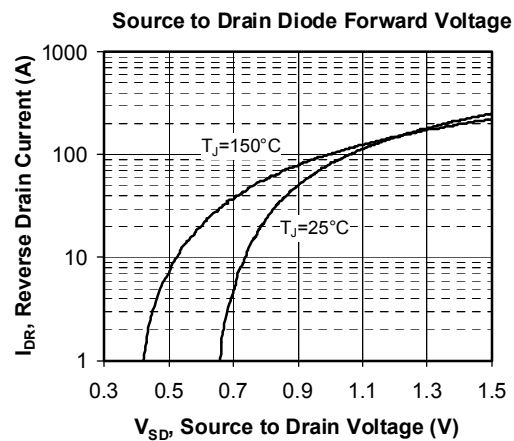
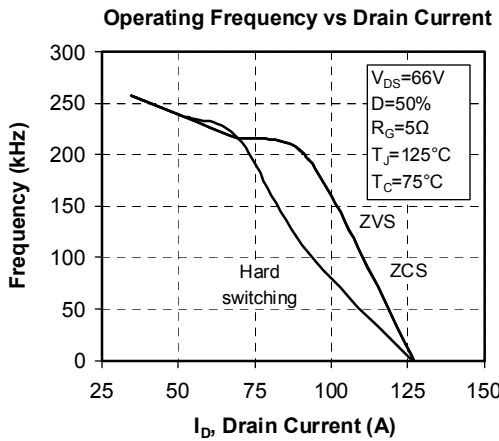
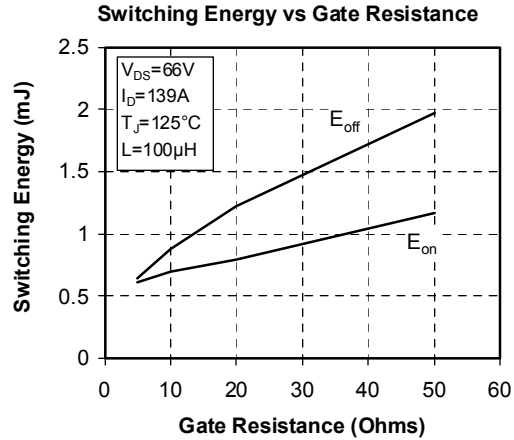
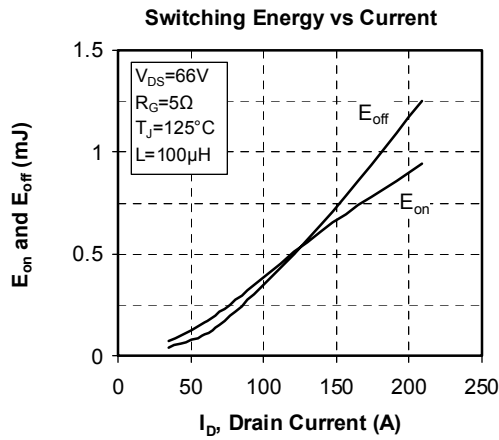
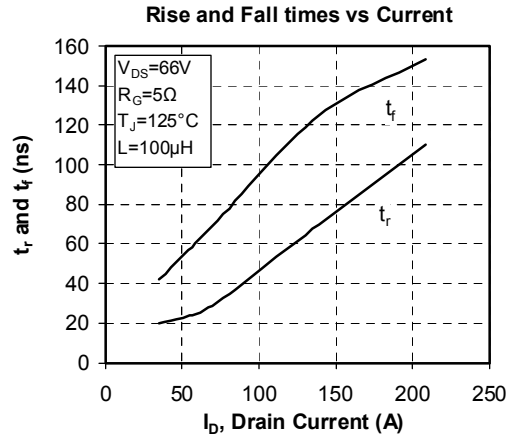
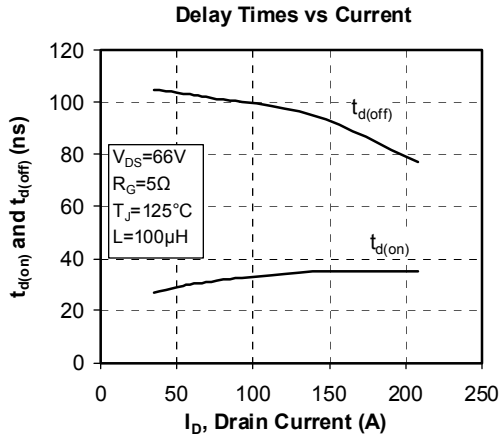

APT reserves the right to change, without notice, the specifications and information contained herein

APT's products are covered by one or more of U.S. patents 4,895,810 5,045,903 5,089,434 5,182,234 5,019,522 5,262,336 6,503,786 5,256,583 4,748,103 5,283,202 5,231,474 5,434,095 5,528,058 and foreign patents. U.S. and Foreign patents pending. All Rights Reserved.