

***Boost chopper
MOSFET Power Module***

**$V_{DSS} = 500V$
 $R_{DSon} = 17m\Omega \text{ max @ } T_j = 25^\circ C$
 $I_D = 180A \text{ @ } T_c = 25^\circ C$**

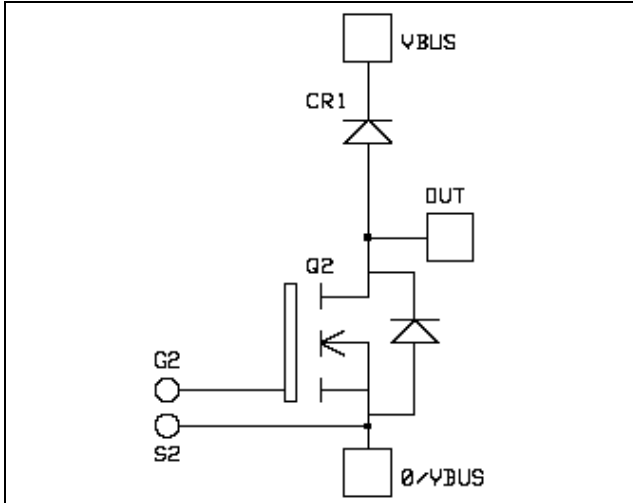

Application

- AC and DC motor control
- Switched Mode Power Supplies
- Power Factor Correction

Features

- Power MOS 7[®] MOSFETs
 - Low R_{DSon}
 - Low input and Miller capacitance
 - Low gate charge
 - Avalanche energy rated
 - Very rugged
- Kelvin source for easy drive
- Very low stray inductance
 - Symmetrical design
 - M5 power connectors
- High level of integration

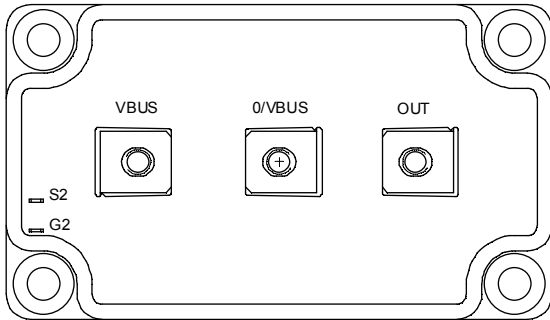

Benefits

- Outstanding performance at high frequency operation
- Direct mounting to heatsink (isolated package)
- Low junction to case thermal resistance
- Low profile

Absolute maximum ratings

Symbol	Parameter	Max ratings	Unit
V_{DSS}	Drain - Source Breakdown Voltage	500	V
I_D	Continuous Drain Current	$T_c = 25^\circ C$	180
		$T_c = 80^\circ C$	135
I_{DM}	Pulsed Drain current	720	A
V_{GS}	Gate - Source Voltage	± 30	V
R_{DSon}	Drain - Source ON Resistance	17	$m\Omega$
P_D	Maximum Power Dissipation	$T_c = 25^\circ C$	1250
I_{AR}	Avalanche current (repetitive and non repetitive)	51	A
E_{AR}	Repetitive Avalanche Energy	50	mJ
E_{AS}	Single Pulse Avalanche Energy	3000	

CAUTION: These Devices are sensitive to Electrostatic Discharge. Proper Handling Procedures Should Be Followed.

All ratings @ $T_j = 25^\circ\text{C}$ unless otherwise specified

Electrical Characteristics

Symbol	Characteristic	Test Conditions	Min	Typ	Max	Unit
BV_{DSS}	Drain - Source Breakdown Voltage	$V_{GS} = 0V, I_D = 500\mu A$	500			V
I_{DSS}	Zero Gate Voltage Drain Current	$V_{GS} = 0V, V_{DS} = 500V, T_j = 25^\circ\text{C}$			200	μA
		$V_{GS} = 0V, V_{DS} = 400V, T_j = 125^\circ\text{C}$			1000	
$R_{DS(on)}$	Drain - Source on Resistance	$V_{GS} = 10V, I_D = 90A$			17	$m\Omega$
$V_{GS(th)}$	Gate Threshold Voltage	$V_{GS} = V_{DS}, I_D = 10mA$	3		5	V
I_{GSS}	Gate - Source Leakage Current	$V_{GS} = \pm 30V, V_{DS} = 0V$			± 200	nA

Dynamic Characteristics

Symbol	Characteristic	Test Conditions	Min	Typ	Max	Unit
C_{iss}	Input Capacitance	$V_{GS} = 0V$ $V_{DS} = 25V$ $f = 1MHz$		28		nF
C_{oss}	Output Capacitance			5.6		
C_{rss}	Reverse Transfer Capacitance			0.36		
Q_g	Total gate Charge	$V_{GS} = 10V$ $V_{Bus} = 250V$ $I_D = 180A$		560		nC
Q_{gs}	Gate - Source Charge			160		
Q_{gd}	Gate - Drain Charge			280		
$T_{d(on)}$	Turn-on Delay Time	Inductive switching @ 125°C $V_{GS} = 15V$ $V_{Bus} = 333V$ $I_D = 180A$ $R_G = 0.5\Omega$		21		ns
T_r	Rise Time			38		
$T_{d(off)}$	Turn-off Delay Time			75		
T_f	Fall Time			93		
E_{on}	Turn-on Switching Energy ❶	Inductive switching @ 25°C $V_{GS} = 15V, V_{Bus} = 333V$ $I_D = 180A, R_G = 0.5\Omega$		4140		μJ
E_{off}	Turn-off Switching Energy ❷			3380		
E_{on}	Turn-on Switching Energy ❶	Inductive switching @ 125°C $V_{GS} = 15V, V_{Bus} = 333V$ $I_D = 180A, R_G = 0.5\Omega$		6224		μJ
E_{off}	Turn-off Switching Energy ❷			4052		

Diode ratings and characteristics

Symbol	Characteristic	Test Conditions	Min	Typ	Max	Unit
$I_{F(AV)}$	Maximum Average Forward Current	50% duty cycle, $T_c = 70^\circ\text{C}$		180		A
V_F	Diode Forward Voltage	$I_F = 180A$		1.6	1.8	V
		$I_F = 360A$		1.9		
		$I_F = 180A, T_j = 125^\circ\text{C}$		1.4		
t_{rr}	Reverse Recovery Time	$I_F = 180A, V_R = 400V, di/dt = 600A/\mu s, T_j = 25^\circ\text{C}$		130		ns
		$I_F = 180A, V_R = 400V, di/dt = 600A/\mu s, T_j = 125^\circ\text{C}$		170		
Q_{rr}	Reverse Recovery Charge	$I_F = 180A, V_R = 400V, di/dt = 600A/\mu s, T_j = 25^\circ\text{C}$		660		nC
		$I_F = 180A, V_R = 400V, di/dt = 600A/\mu s, T_j = 125^\circ\text{C}$		2760		

❶ E_{on} includes diode reverse recovery.

❷ In accordance with JEDEC standard JESD24-1.

Thermal and package characteristics

Symbol	Characteristic		Min	Typ	Max	Unit
R _{thJC}	Junction to Case	Transistor			0.1	°C/W
		Diode			0.32	
V _{ISOL}	RMS Isolation Voltage, any terminal to case t = 1 min, I _{isol} < 1mA, 50/60Hz		2500			V
T _J	Operating junction temperature range		-40		150	°C
T _{STG}	Storage Temperature Range		-40		125	
T _C	Operating Case Temperature		-40		100	
Torque	Mounting torque	To heatsink	M6	3	5	N.m
		For terminals	M5	2	3.5	
Wt	Package Weight				280	g

Package outline

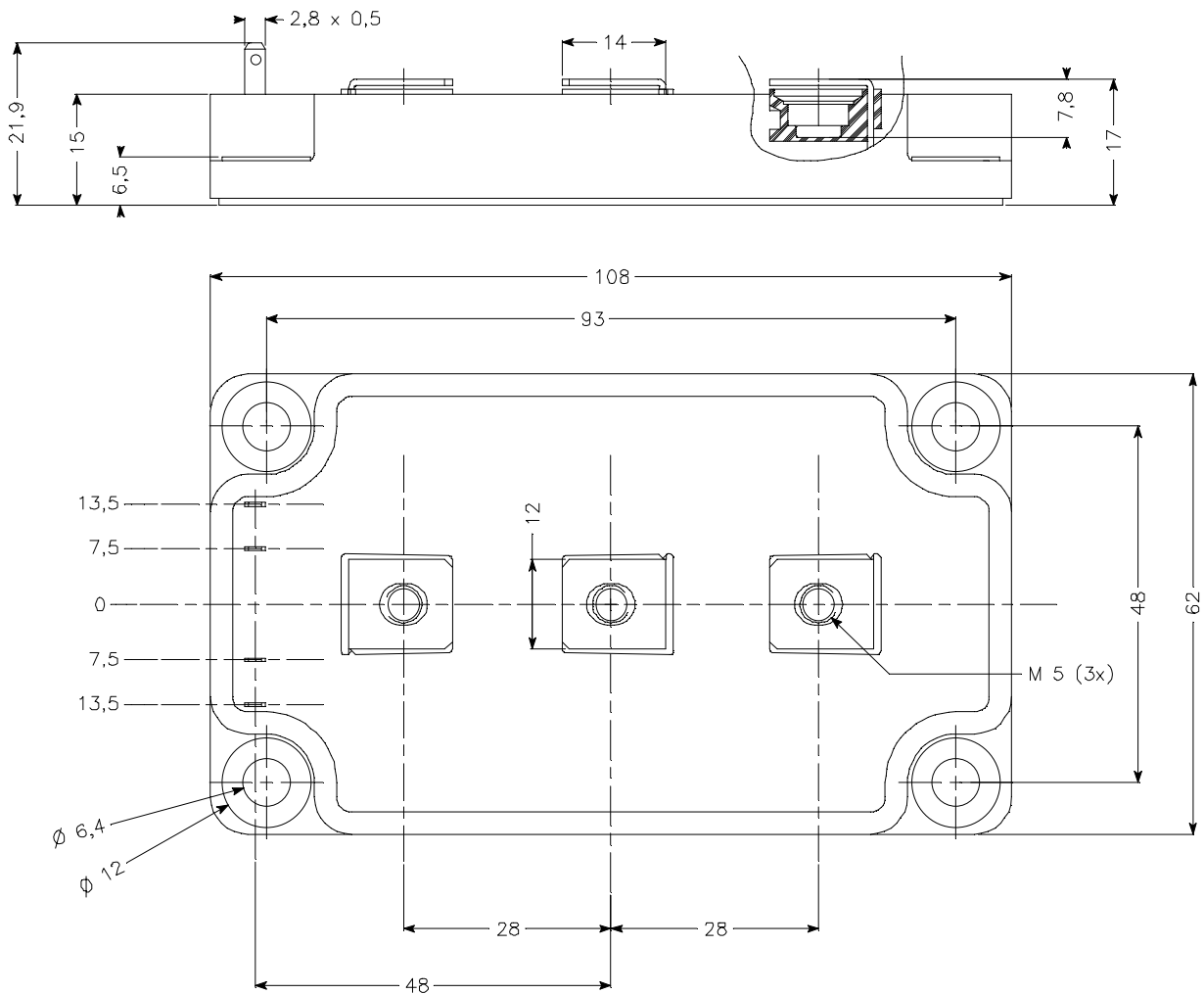

Typical Performance Curve

Maximum Effective Transient Thermal Impedance, Junction to Case vs Pulse Duration

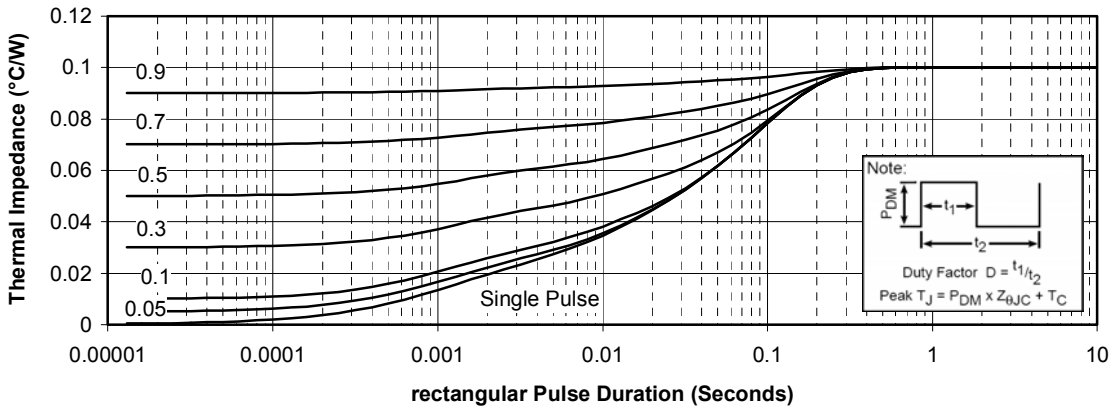

Low Voltage Output Characteristics

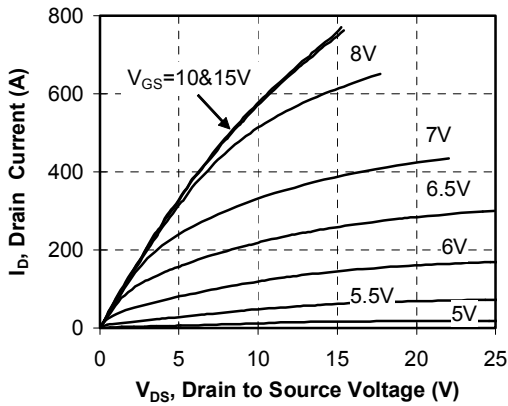

Transfer Characteristics

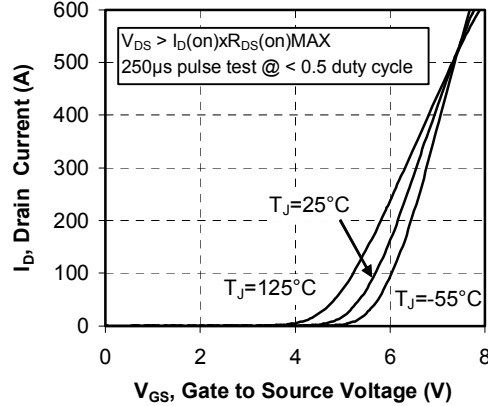

RDS(on) vs Drain Current

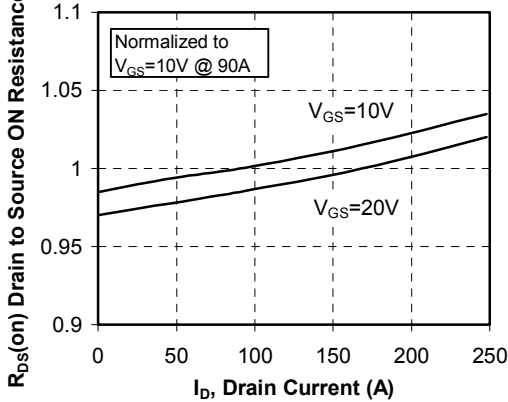

DC Drain Current vs Case Temperature

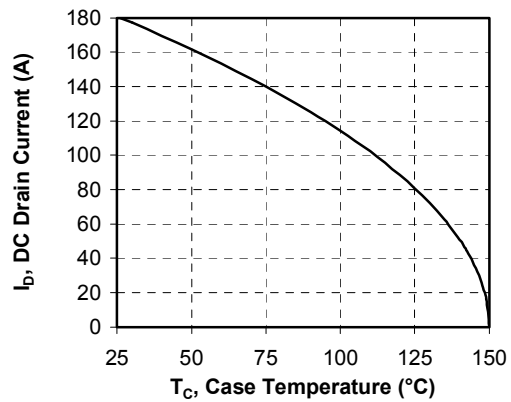

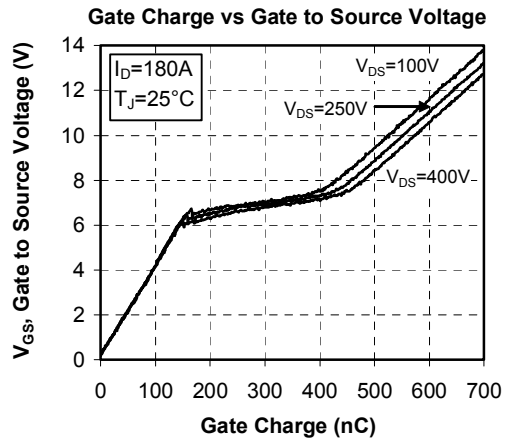
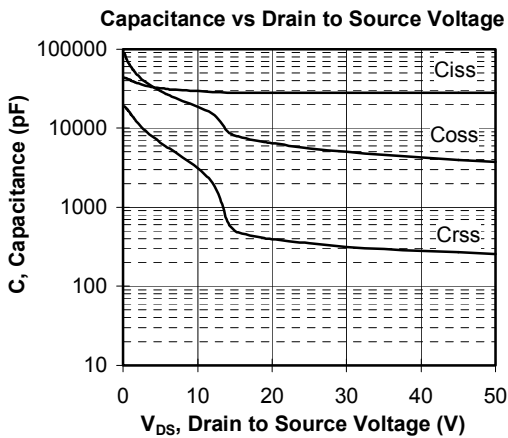
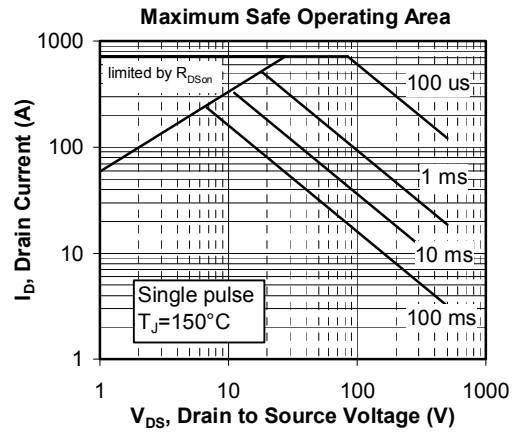
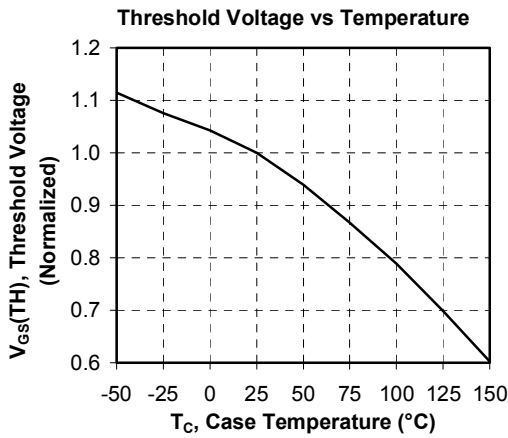
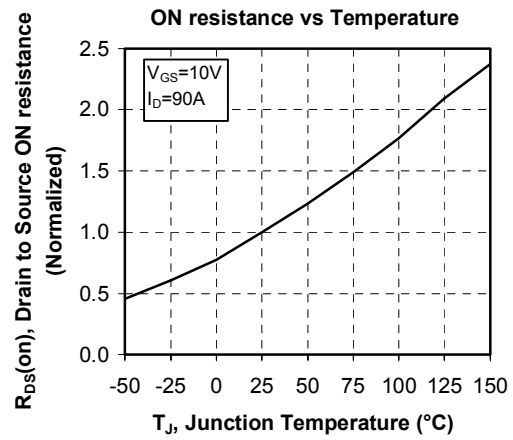
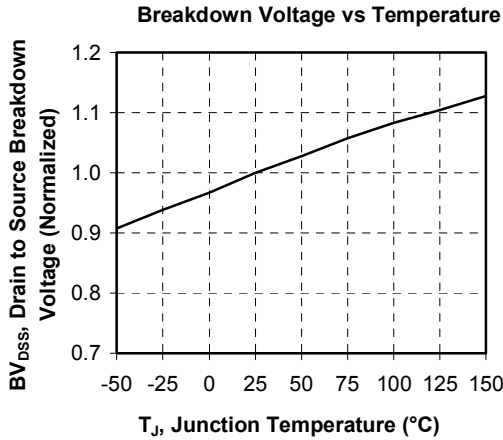

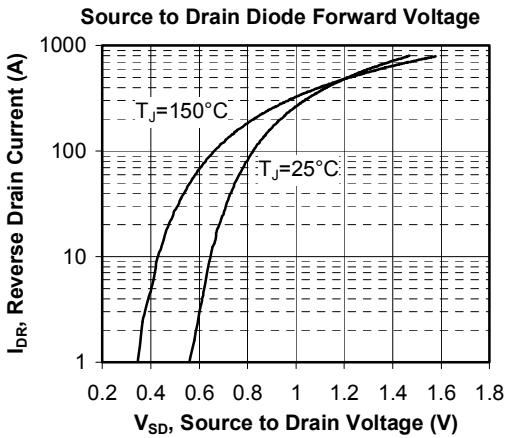
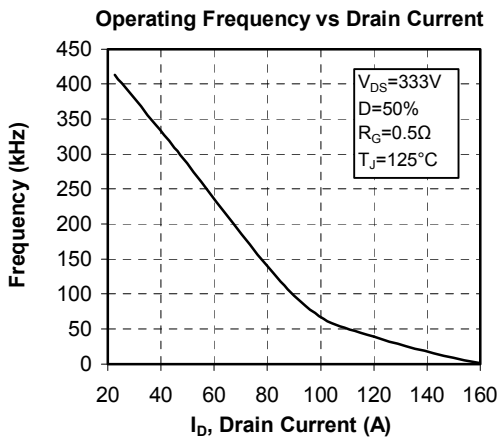
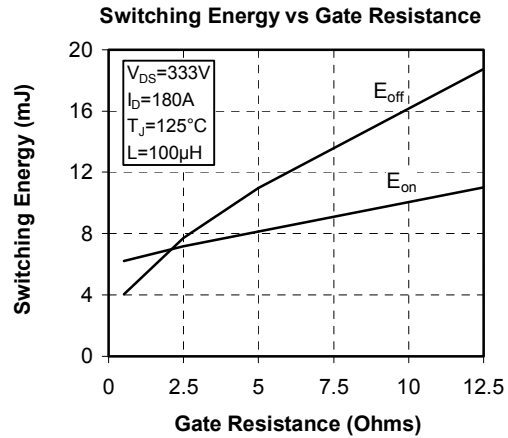
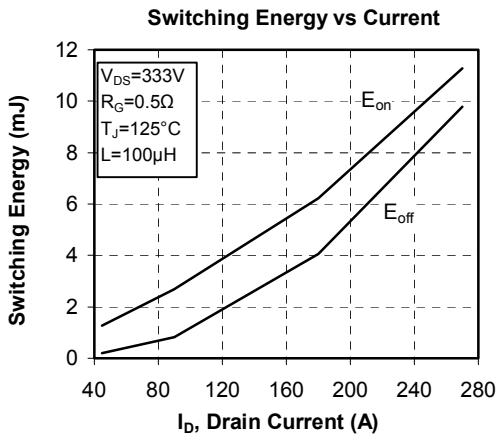
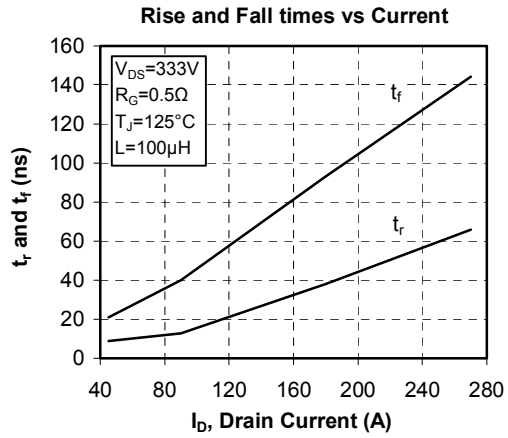
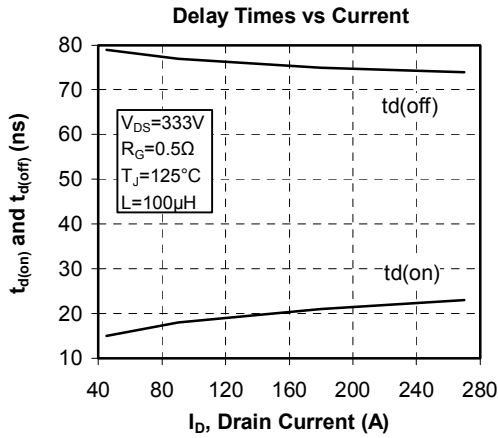

APT reserves the right to change, without notice, the specifications and information contained herein

APT's products are covered by one or more of U.S. patents 4,895,810 5,045,903 5,089,434 5,182,234 5,019,522 5,262,336 6,503,786 5,256,583 4,748,103 5,283,202 5,231,474 5,434,095 5,528,058 and foreign patents. U.S. and Foreign patents pending. All Rights Reserved.