

**Boost chopper
MOSFET Power Module**

**$V_{DSS} = 500V$
 $R_{DSon} = 38m\Omega$ max @ $T_j = 25^\circ C$
 $I_D = 90A$ @ $T_c = 25^\circ C$**

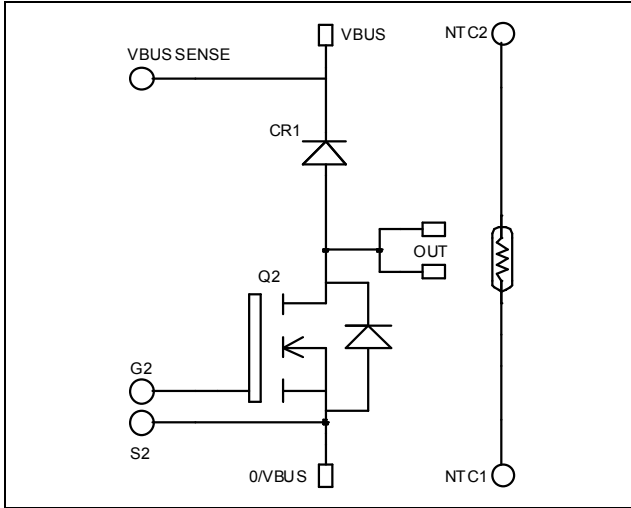

Application

- AC and DC motor control
- Switched Mode Power Supplies
- Power Factor Correction

Features

- Power MOS 7[®] MOSFETs
 - Low R_{DSon}
 - Low input and Miller capacitance
 - Low gate charge
 - Avalanche energy rated
 - Very rugged
- Kelvin source for easy drive
- Very low stray inductance
 - Symmetrical design
 - Lead frames for power connections
- Internal thermistor for temperature monitoring
- High level of integration

Benefits

- Outstanding performance at high frequency operation
- Direct mounting to heatsink (isolated package)
- Low junction to case thermal resistance
- Solderable terminals both for power and signal for easy PCB mounting
- Low profile

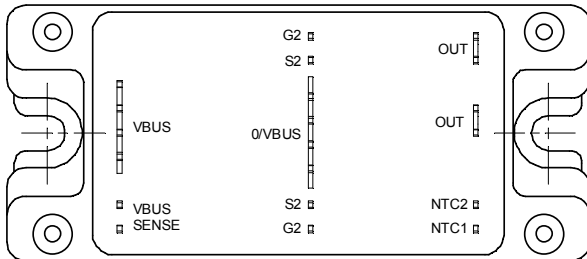

Absolute maximum ratings

Symbol	Parameter	Max ratings	Unit
V_{DSS}	Drain - Source Breakdown Voltage	500	V
I_D	Continuous Drain Current	$T_c = 25^\circ C$	90
		$T_c = 80^\circ C$	67
I_{DM}	Pulsed Drain current	360	
V_{GS}	Gate - Source Voltage	± 30	V
R_{DSon}	Drain - Source ON Resistance	38	m Ω
P_D	Maximum Power Dissipation	$T_c = 25^\circ C$	694
I_{AR}	Avalanche current (repetitive and non repetitive)	46	A
E_{AR}	Repetitive Avalanche Energy	50	mJ
E_{AS}	Single Pulse Avalanche Energy	2500	

CAUTION: These Devices are sensitive to Electrostatic Discharge. Proper Handling Procedures Should Be Followed.

All ratings @ $T_j = 25^\circ\text{C}$ unless otherwise specified

Electrical Characteristics

Symbol	Characteristic	Test Conditions	Min	Typ	Max	Unit
BV_{DSS}	Drain - Source Breakdown Voltage	$V_{GS} = 0V, I_D = 375\mu A$	500			V
I_{DSS}	Zero Gate Voltage Drain Current	$V_{GS} = 0V, V_{DS} = 500V$			150	μA
		$V_{GS} = 0V, V_{DS} = 400V$			750	
$R_{DS(on)}$	Drain - Source on Resistance	$V_{GS} = 10V, I_D = 45A$			38	$m\Omega$
$V_{GS(th)}$	Gate Threshold Voltage	$V_{GS} = V_{DS}, I_D = 5mA$	3		5	V
I_{GSS}	Gate - Source Leakage Current	$V_{GS} = \pm 30V, V_{DS} = 0V$			± 150	nA

Dynamic Characteristics

Symbol	Characteristic	Test Conditions	Min	Typ	Max	Unit
C_{iss}	Input Capacitance	$V_{GS} = 0V$ $V_{DS} = 25V$ $f = 1MHz$		11.2		nF
C_{oss}	Output Capacitance			2.4		
C_{rss}	Reverse Transfer Capacitance			0.18		
Q_g	Total gate Charge	$V_{GS} = 10V$ $V_{Bus} = 250V$ $I_D = 90A$		246		nC
Q_{gs}	Gate - Source Charge			66		
Q_{gd}	Gate - Drain Charge			130		
$T_{d(on)}$	Turn-on Delay Time	Inductive switching @ 125°C $V_{GS} = 15V$ $V_{Bus} = 333V$ $I_D = 90A$ $R_G = 2\Omega$		18		ns
T_r	Rise Time			35		
$T_{d(off)}$	Turn-off Delay Time			87		
T_f	Fall Time			77		
E_{on}	Turn-on Switching Energy ①	Inductive switching @ 25°C $V_{GS} = 15V, V_{Bus} = 333V$ $I_D = 90A, R_G = 2\Omega$		1510		μJ
E_{off}	Turn-off Switching Energy ②			1452		
E_{on}	Turn-on Switching Energy ①	Inductive switching @ 125°C $V_{GS} = 15V, V_{Bus} = 333V$ $I_D = 90A, R_G = 2\Omega$		2482		μJ
E_{off}	Turn-off Switching Energy ②			1692		

Diode ratings and characteristics

Symbol	Characteristic	Test Conditions	Min	Typ	Max	Unit
$I_{F(AV)}$	Maximum Average Forward Current	50% duty cycle $T_c = 70^\circ\text{C}$		60		A
V_F	Diode Forward Voltage	$I_F = 60A$		1.6	1.8	V
		$I_F = 120A$		1.9		
		$I_F = 60A$	$T_j = 125^\circ\text{C}$		1.4	
t_{rr}	Reverse Recovery Time	$I_F = 60A$ $V_R = 400V$ $di/dt = 200A/\mu s$	$T_j = 25^\circ\text{C}$		130	ns
			$T_j = 125^\circ\text{C}$		170	
Q_{rr}	Reverse Recovery Charge	$I_F = 60A$ $V_R = 400V$ $di/dt = 200A/\mu s$	$T_j = 25^\circ\text{C}$		220	nC
			$T_j = 125^\circ\text{C}$		920	

① E_{on} includes diode reverse recovery.

② In accordance with JEDEC standard JESD24-1.

Thermal and package characteristics

Symbol	Characteristic	Min	Typ	Max	Unit	
R _{thJC}	Junction to Case	Transistor		0.18	°C/W	
		Diode		0.9		
V _{ISOL}	RMS Isolation Voltage, any terminal to case t = 1 min, I _{isol} < 1mA, 50/60Hz	2500			V	
T _J	Operating junction temperature range	-40		150	°C	
T _{STG}	Storage Temperature Range	-40		125		
T _C	Operating Case Temperature	-40		100		
Torque	Mounting torque		To Heatsink	M5	4.7	N.m
Wt	Package Weight				160	g

Temperature sensor NTC

Symbol	Characteristic	Min	Typ	Max	Unit
R ₂₅	Resistance @ 25°C		68		kΩ
B _{25/85}	T ₂₅ = 298.16 K		4080		K

$$R_T = \frac{R_{25}}{\exp \left[B_{25/85} \left(\frac{1}{T_{25}} - \frac{1}{T} \right) \right]}$$

T: Thermistor temperature
R_T: Thermistor value at T

Package outline

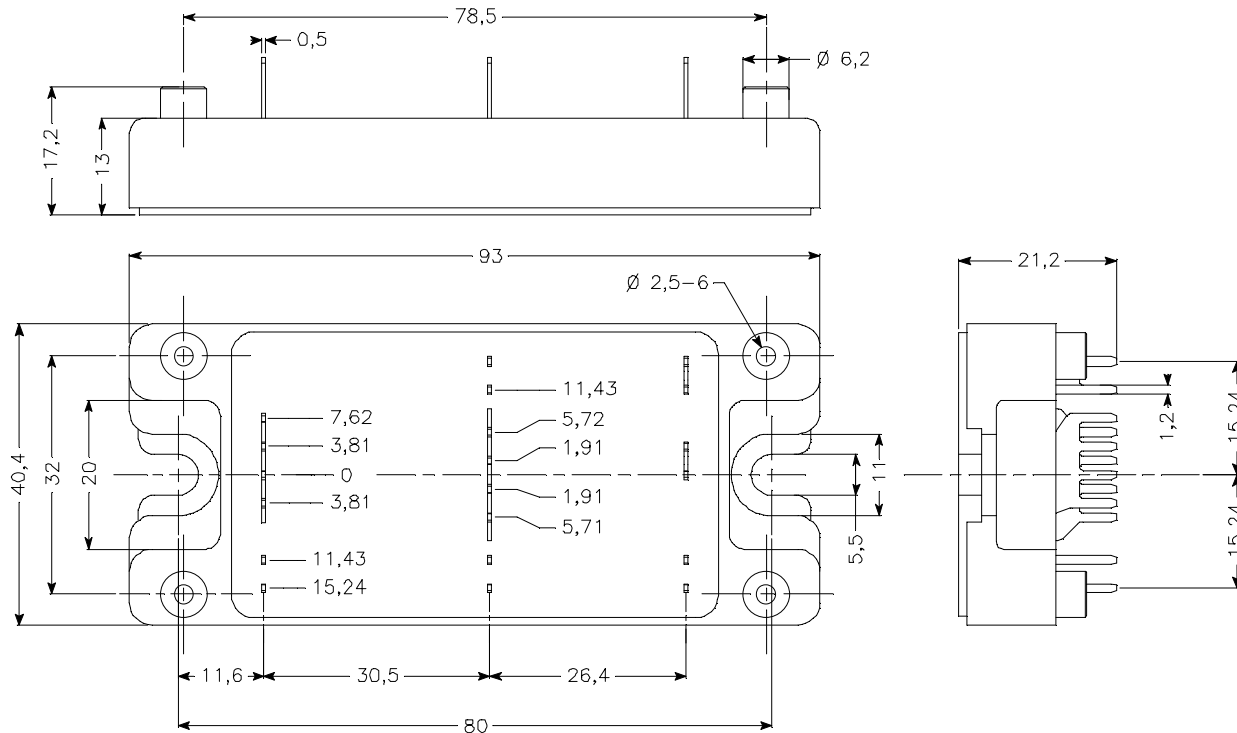

Typical Performance Curve

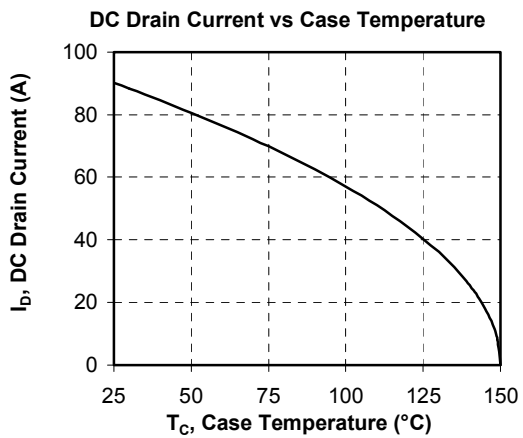
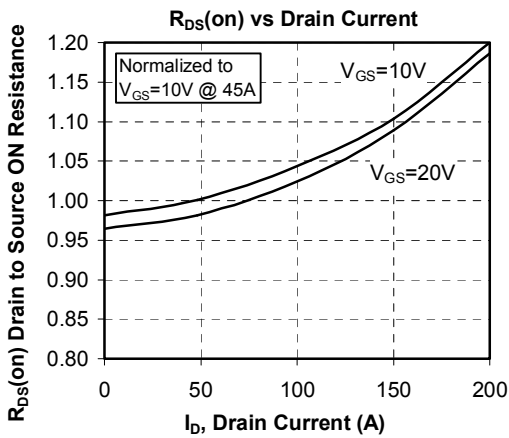
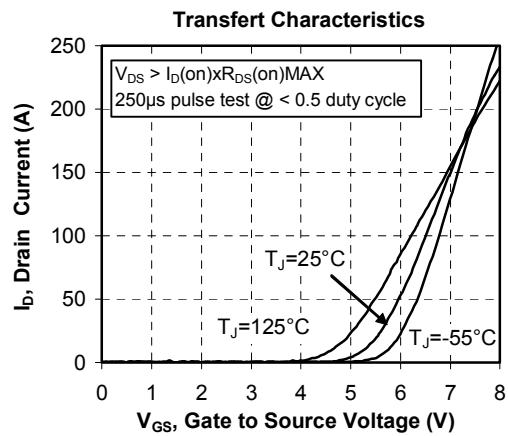
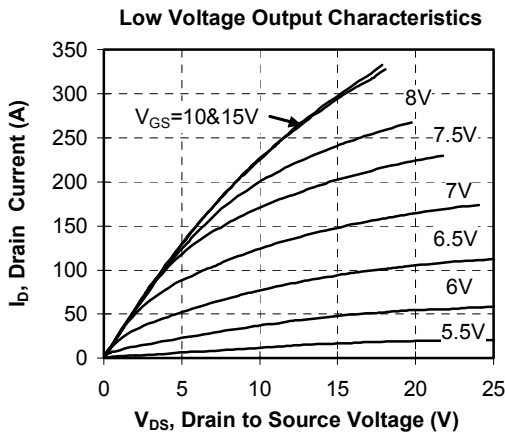
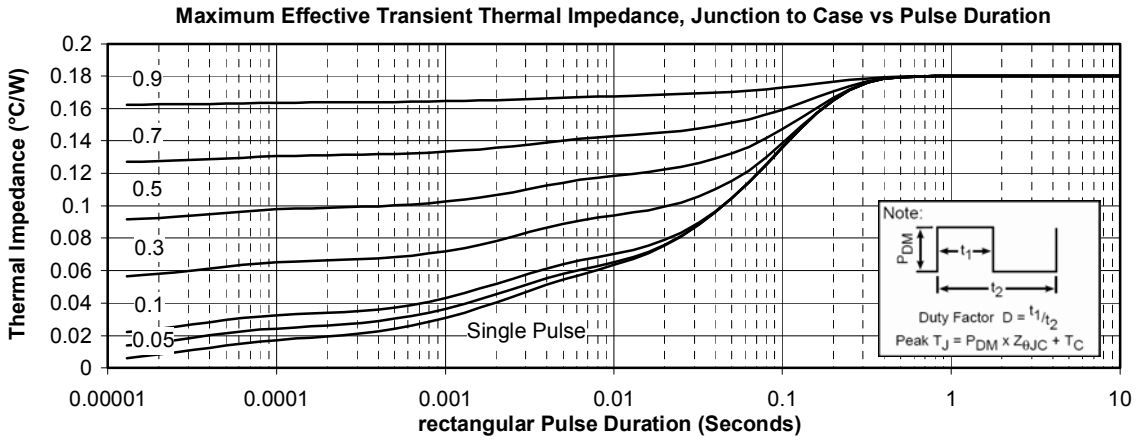

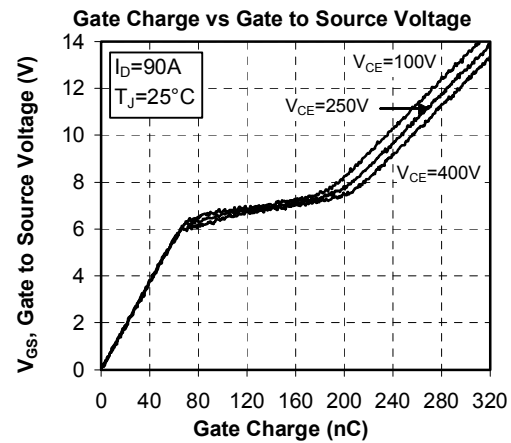
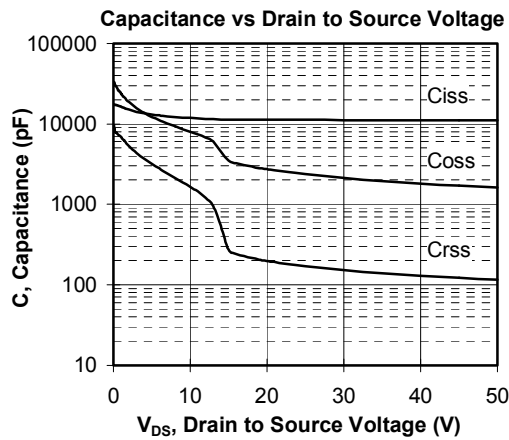
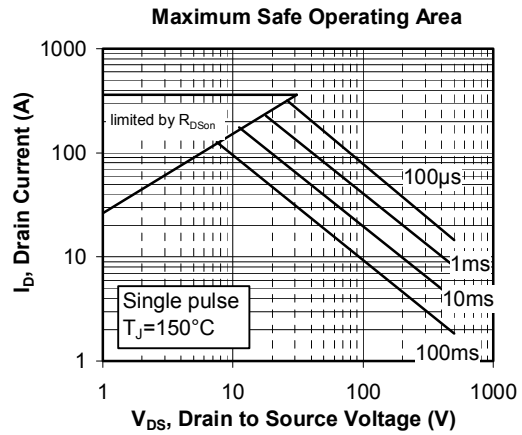
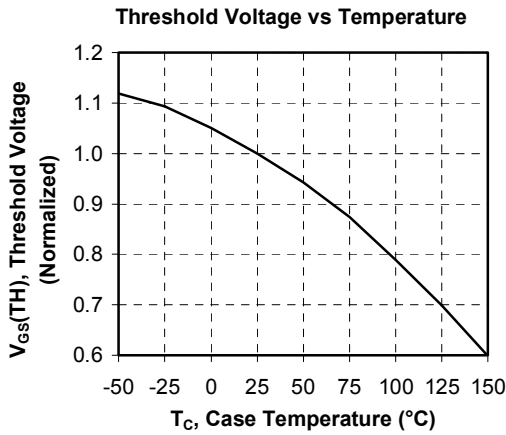
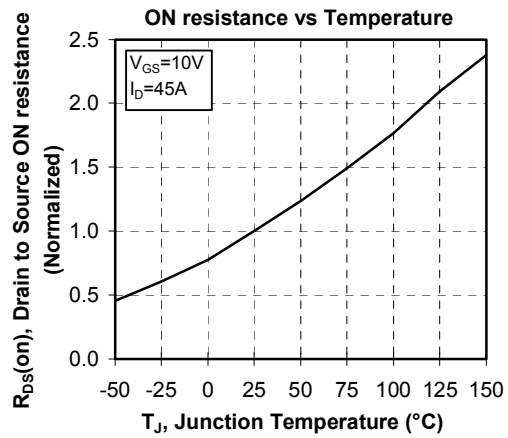
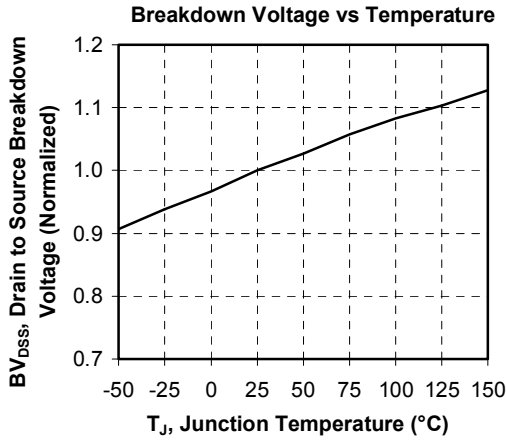

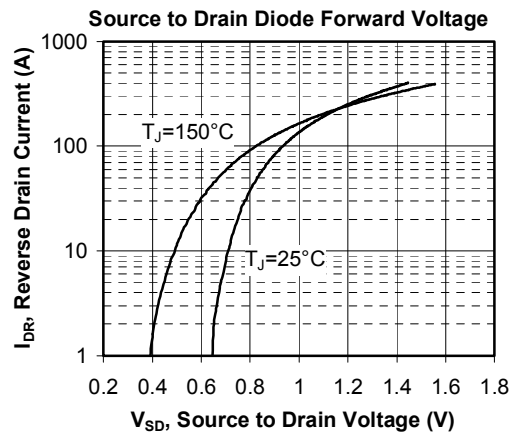
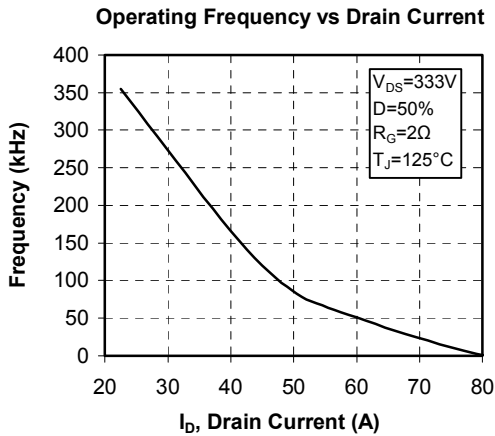
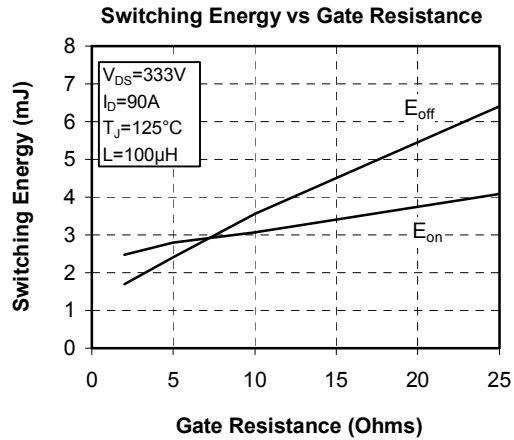
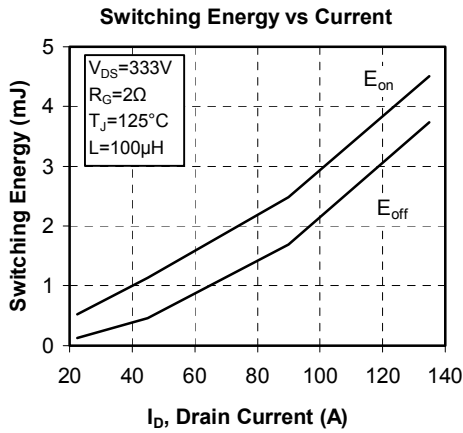
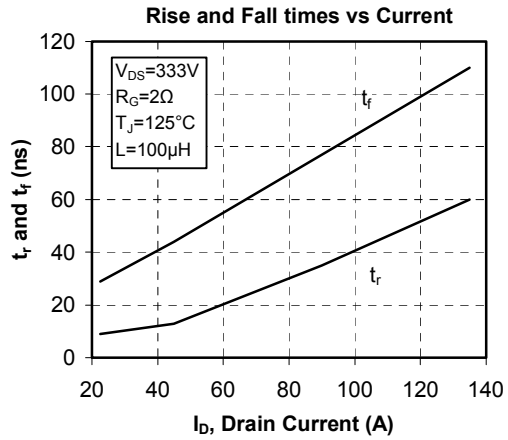
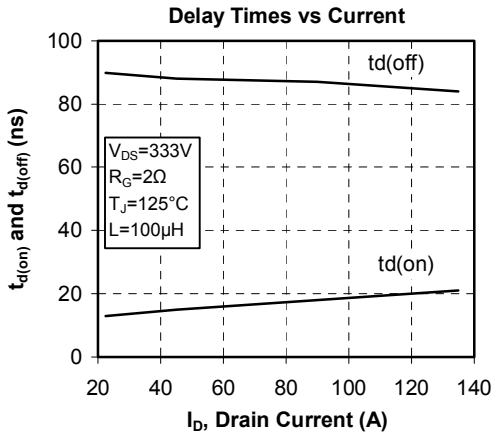

APT reserves the right to change, without notice, the specifications and information contained herein

APT's products are covered by one or more of U.S. patents 4,895,810 5,045,903 5,089,434 5,182,234 5,019,522 5,262,336 6,503,786 5,256,583 4,748,103 5,283,202 5,231,474 5,434,095 5,528,058 and foreign patents. U.S. and Foreign patents pending. All Rights Reserved.