

# **AZ DISPLAYS, INC.**

---

*COMPLETE LCD SOLUTIONS*

## **SPECIFICATIONS FOR LIQUID CRYSTAL DISPLAY**

PART NUMBER: □□ □ □ AQM1264C-FL-YBW-T

DATE: □ □ □ □ □ □ AUGUST 21, 2007



# AQM1264C-FL-YBW GRAPHIC MODULE VER1.0

## 2.0 MECHANICAL SPECIFICATION

1. Number of dots	128x64
2. Module dimension	93.7mm(L) x 52.6mm(W) x 6.8mm(T)
3. Active display area (A/A)	66.52mm(L) x 33.24mm(W)
4. View area (V/A)	70.7mm(L) x 38.8mm(W)
5. Dot Size	0.5mm(W) x 0.5mm(H)
6. Dot Pitch	0.52mm(W) x 0.52mm(H)
7. Driver method	1/65 duty, 1/9 bias, Vop=8.3V, boosting 4X
8. Display mode	Positive STN Transflective Yellow-Green
9. LCD type	STN/ YELLOW-GREEN
10. Driver IC	NT7538H COG
11. Backlight Options	Yellow-Green

## 3.0 ABSOLUTE MAXIMUM RATINGS

Item	Min	Typ	Max	Unit
DC Supply Voltage(VDD)	-0.3		4.0	V
DC Supply Voltage(Vout)	-0.3		15	V
DC Supply Voltage(V0)	-0.3		15	V
Input Voltage	-0.3		VDD+0.3	V
Operating Temperature	-20		70	°C
Storage Temperature	-30		80	°C

## 4.0 ELECTRICAL CHARACTERISTICS

Item	Sy	mbol	Condition	Min	Typ	Max	Unit
Power Supply		$V_{DD}-V_{SS}$		1.8	3.0	3.3	V
Input voltage (high)		Vih	H level	0.8 $V_{DD}$	-	$V_{DD}$	V
Input voltage (low)		Vil	L level	Vss	-	0.2 $V_{DD}$	V
Output voltage (high)		Voh	H level	0.8 $V_{DD}$		$V_{DD}$	V
Output voltage (low)		Vol	L level	0.2 $V_{DD}$		$V_{DD}$	V
Power Supply Current		Idd	Vdd=3.3V		1.3	1.8	mA
LED Power Supply Voltage		A-K		4.0	4.2	4.5	V
LED Power Supply Current		$I_{BL}$			120	-	mA
Luminance	Lv		Covered by LCD and Touch panel	3.5	5.5	-	cd/m2
Luminance evenness		-	Same part(Min/Max)	70%			-

# AQM1264C-FL-YBW GRAPHIC MODULE VER1.0

## 5.0 TOUCH PANEL CHARACTERISTICS

Item	Min	Typ	Max	Unit
Type	Resistor analog, 4-wire FPC interface Film/Glass			
Power supply	-	5.0	-	V(DC)
Operating force	30	-	70	g
Life time	1KK	-	-	times
Light transmission	75%			-
Chattering time			10	ms

## 6.0 BLOCK DIAGRAM

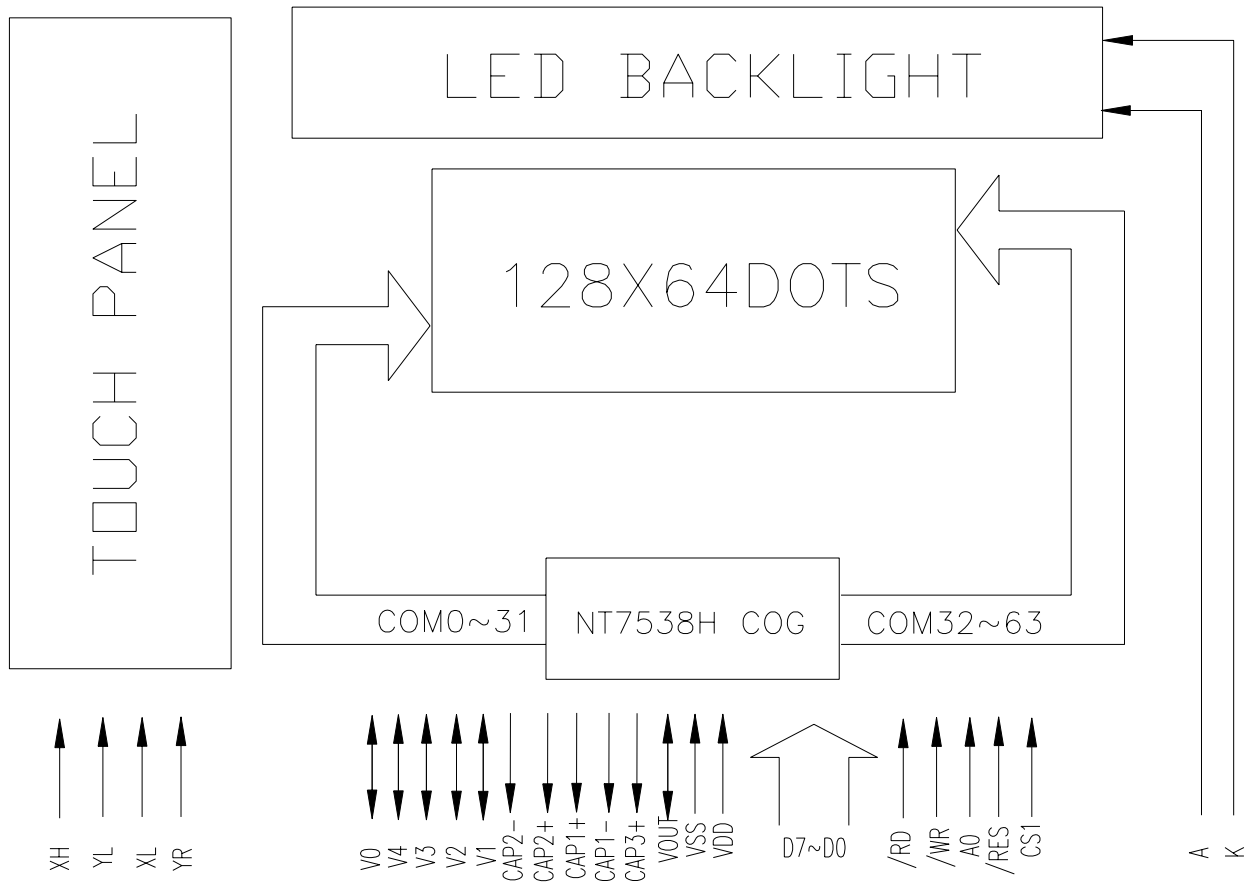

# AQM1264C-FL-YBW GRAPHIC MODULE VER1.0

## 7.0 PIN ASSIGNMENT

Pin No	I/O	Name	Description
1	I	CS1	Chip select signal. Active when low
2	I	/RES	Chip reset signal. Active when low
3	I	A0	It decide whether the data bits are data or a command. "L" is for command and "H" is for data.
4	I	/WR	Write signal. Active when low
5	I	/RD	Read signal. Active when low
6~13	I/O	D0~D7	8-bit directional data bus
14	I	VDD	Power supply
15	I	VSS	Power supply
16	I/O	VOUT	DC/DC voltage converter output
17	O	CAP3+	Pins for DC/DC voltage converter
18	O	CAP1-	
19	O	CAP1+	
20	O	CAP2+	
21	O	CAP2-	
22~26	I/O	V1~V0	LCD driver supplies voltages

## 8.0 LCD OPTICAL CHARACTERISTICS

Item	Symbol	Test condition	Min.	Typ.	Max.	Unit	Note
Viewing angle	1- 2	$T=25^{\circ}\text{C}, \text{CR}=2$	-	65	-	Degree	Note2
	1			45	-		
	2			-20	-		
				-	$\pm 35$		
Contrast ratio	K1	$=0^{\circ}, =0^{\circ}$	6	-	-	-	Note3
Rise time	tr1	$=0^{\circ}, =0^{\circ}$		150	250	ms	Note4
Fall time	td1	Transflective mode		150	250	ms	Note4

Note 2: Definition of angle  $\theta_1$  and  $\theta_2$ .

$\theta_1$ : Angle measured from normal to direction of observation.

$\theta_2$ : Azimuth angle measured counter-clockwise from X-axis.

Note 3 : Definition of Contrast ratio

The contrast ratio is defined to be the ratio of transmission or reflection of a symbol at its "on" and "off" state.

$$\text{Contrast ratio(K)} = \frac{\text{Transmission/Reflectance at "OFF" state}}{\text{Transmission/Reflectance at "ON" state}}$$

Note 4 : Definition of response time

At specific operating voltage and temperature, the times measured by observing contrast or transmission ratio.

# AQM1264C-FL-YBW GRAPHIC MODULE VER1.0

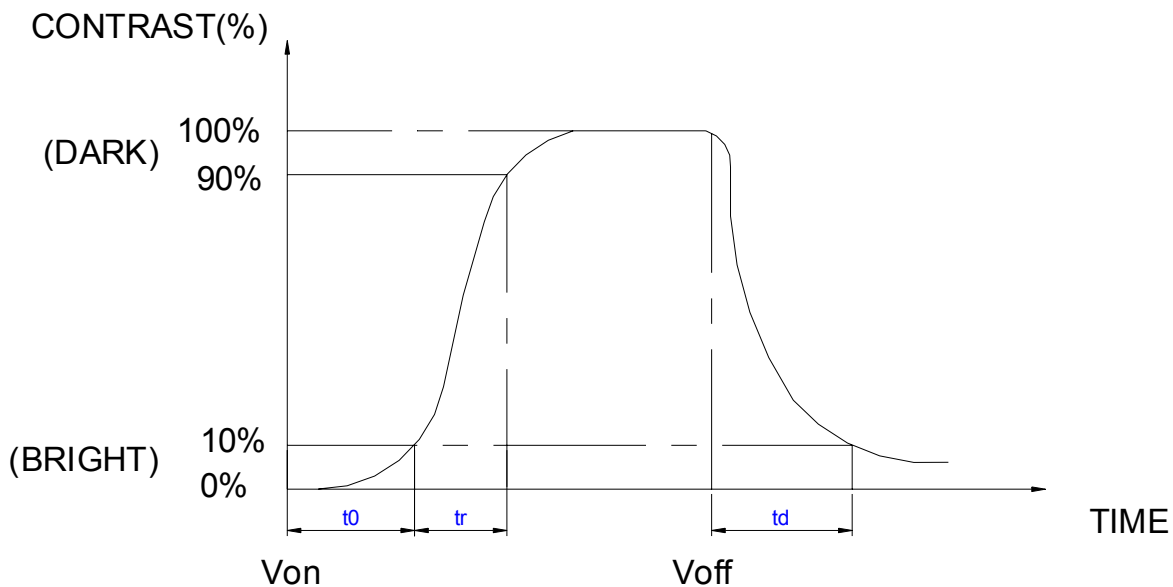
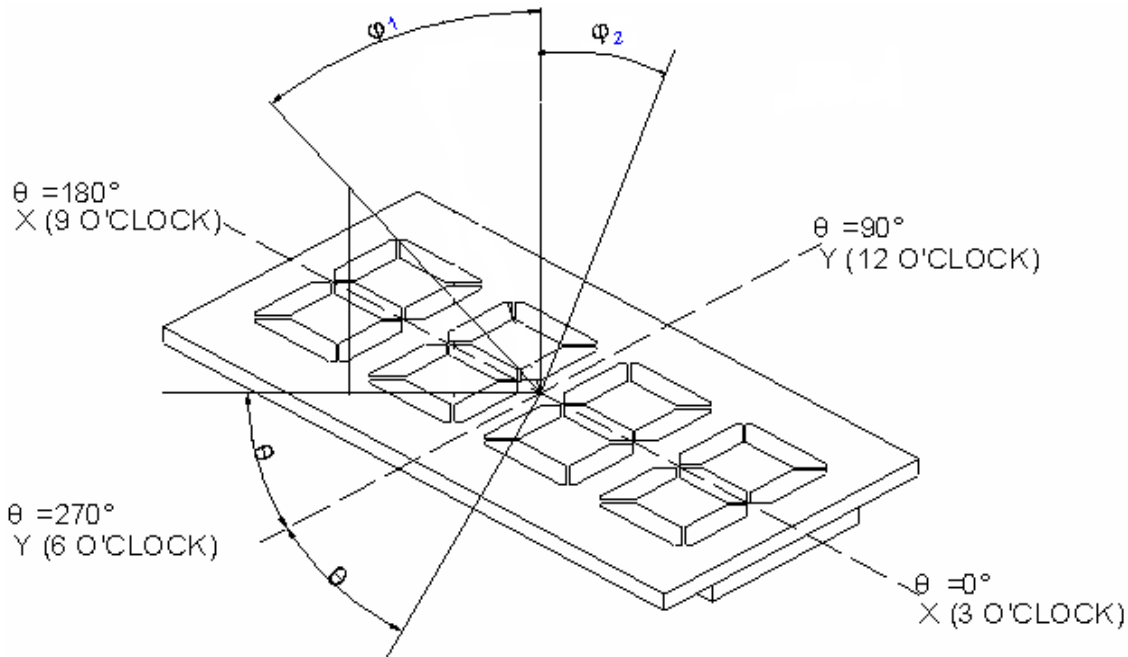

Delay time  $t_0$  : Measured between zero and 10% with  $V_{on}$ .

Rise time  $t_r$  : Measured between 10% and 90% of LCD segment maximum response with  $V_{on}$

Decay time  $t_d$  : With voltage switches to zero and the instant LCD segment reaches 10% of its maximum response

$T_{on}$  : Time measured between the instant operating voltage is applied to display and the instant the display reaches 90% of its maximum response.

$T_{off}$  : Time measured between the instant operating voltage switches to zero and the instant the display reaches 10% of its maximum response.

## LIQUID CRYSTAL PANEL LIFE TIME

50000 hours minimum at  $25^{\circ}\text{C} \pm 10^{\circ}\text{C}$  and 65% RH maximum.

Note: Definition of life time : the time up to occurrence of any of the following:

Contrast reduces to 30% of the initial value.

Current consumption becomes three times the initial value.

Orientation deteriorates significantly.

**9.0 TIMING CHARACTERISTICS**

**AC Characteristics**

1. System Buses Read/Write Characteristics (for 8080 Series MPU)

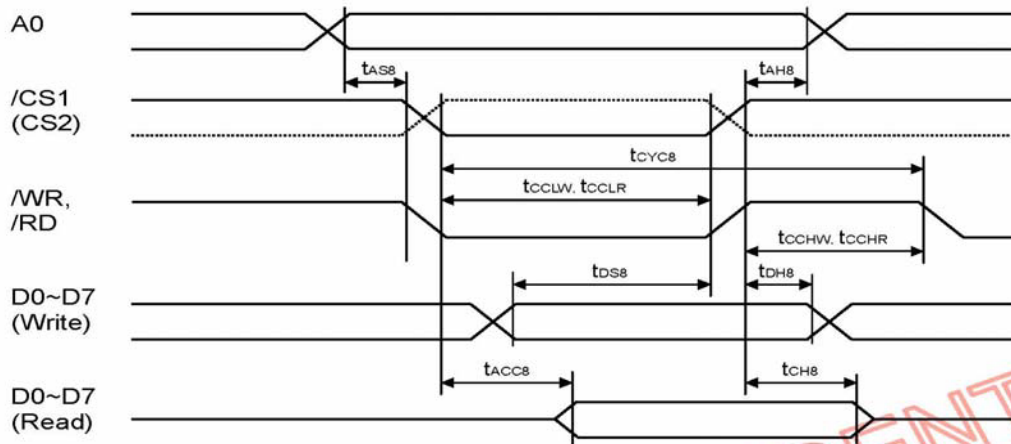

(VDD = 2.7 ~ 3.6V, Ta = -40 ~ +85°C)

Symbol	Parameter	Min.	Typ.	Max.	Unit	Condition
T <sub>AH8</sub>	Address hold time	0	-	-	ns	A0
T <sub>AS8</sub>	Address setup time	0	-	-	ns	
tcyc8	System cycle time	240	-	-	ns	
tcclw	Control low pulse width (write)	90	-	-	ns	/WR
tcclr	Control low pulse width (read)	120	-	-	ns	/RD
tcchw	Control high pulse width (write)	100	-	-	ns	/WR
tcchr	Control high pulse width (read)	60	-	-	ns	/RD
T <sub>DS8</sub>	Data setup time	40	-	-	ns	D0~D7
T <sub>DH8</sub>	Data hold time	0	-	-	ns	
tacc8	/RD access time	-	-	140	ns	D0~D7, CL = 100pF
T <sub>CH8</sub>	Output disable time	5	-	50	ns	

System Buses Read/Write Characteristics (for 8080 Series MPU) (continued)

(VDD = 1.8 ~ 2.7V, Ta = -40 ~ +85°C)

Symbol	Parameter	Min.	Typ.	Max.	Unit	Condition
t <sub>AH8</sub>	Address hold time	0	-	-	ns	A0
t <sub>AS8</sub>	Address setup time	0	-	-	ns	
tcyc8	System cycle time	400	-	-	ns	
tcclw	Control low pulse width (write)	150	-	-	ns	/WR
tcclr	Control low pulse width (read)	150	-	-	ns	/RD
tcchw	Control high pulse width (write)	120	-	-	ns	/WR
tcchr	Control high pulse width (read)	120	-	-	ns	/RD
t <sub>DS8</sub>	Data setup time	80	-	-	ns	D0~D7
t <sub>DH8</sub>	Data hold time	0	-	-	ns	
tacc8	/RD access time	-	-	240	ns	D0~D7, CL = 100pF
tch8	Output disable time	10	-	100	ns	

- \*1. The input signal rise time and fall time (tr, tf) is specified at 15ns or less.  
(tr + tf) < (tcyc8 - tcclw - tcchw) for write, (tr + tf) < (tcyc8 - tcclr - tcchr) for read.
- \*2. All timing is specified using 20% and 80% of VDD as the reference.
- \*3. tcclw and tcclr are specified as the overlap interval when /CS1 is low (CS2 is high) and /WR or /RD is low.

# AQM1264C-FL-YBW GRAPHIC MODULE VER1.0

## Reset Timing

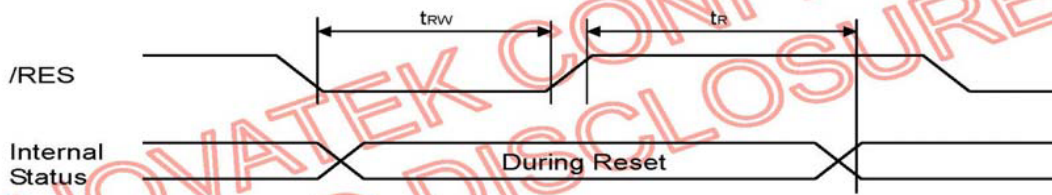

(VDD = 2.7 ~ 3.6V, Ta = -40 ~ +85°C)

Symbol	Parameter	Min.	Typ.	Max.	Unit	Condition
t <sub>R</sub>	Reset Time	-	-	1.0	μs	
t <sub>rw</sub>	Reset low pulse width	10	-	-	μs	/RES

(VDD = 1.8 ~ 2.7V, Ta = -40 ~ +85°C)

Symbol	Parameter	Min.	Typ.	Max.	Unit	Condition
t <sub>R</sub>	Reset Time	-	-	2.0	μs	
t <sub>rw</sub>	Reset low pulse width	20	-	-	μs	/RES

## 10.0 COMMAND SETTING DESCRIPTION

Command	A0	/RD	/WR	Code								Hex	Function	
				D7	D6	D5	D4	D3	D2	D1	D0			
(1) Display OFF	0	1	0	1	0	1	0	1	1	1	0	1	AEh AFh	Turn on LCD panel when high, and turn off when low
(2) Display Start Line Set	0	1	0	0	1	Display Start Address					40h to 7Fh	Specifies RAM display line for COM0		
(3) Page Address Set	0	1	0	1	0	1	1	Page Address				B0h to B8h	Set the display data RAM page in Page Address register	
(4) Column Address Set	0	1	0	0	0	0	1	Higher Column Address				00h to 18h	Set 4 higher bits and 4 lower bits of column address of display data RAM in register	
	0	1	0	0	0	0	0	Lower Column Address						
(5) Read Status	0	0	1	Status				0	0	0	0	XX	Reads the status information	
(6) Write Display Data	1	1	0	Write Data								XX	Write data in display data RAM	
(7) Read Display Data	1	0	1	Read Data								XX	Read data from display data RAM	
(8) ADC Select	0	1	0	1	0	1	0	0	0	0	0	1	A0h A1h	Set the display data RAM address SEG output correspondence
(9) Normal/Reverse Display	0	1	0	1	0	1	0	0	1	1	0	1	A6h A7h	Normal indication when low, but full indication when high
(10) Entire Display ON/OFF	0	1	0	1	0	1	0	0	1	0	0	1	A4h A5h	Select normal display (0) or entire display on
(11) LCD Bias Set	0	1	0	1	0	1	0	0	0	1	0	1	A2h A3h	Sets LCD driving voltage bias ratio
(12) Read-Modify-Write	0	1	0	1	1	1	0	0	0	0	0	0	E0h	Increments column address counter during each write
(13) End	0	1	0	1	1	1	0	1	1	1	0	0	E0h	Releases the Read-Modify-Write
(14) Reset	0	1	0	1	1	1	0	0	0	1	0	0	E2h	Resets internal functions
(15) Common Output Mode Select	0	1	0	1	1	0	0	0	*	*	*	*	C0h to CFh	Select COM output scan direction *: invalid data
(16) Power Control Set	0	1	0	0	0	1	0	1	Operation Status			28h to 2Fh	Select the power circuit operation mode	
(17) V0 Voltage Regulator Internal Resistor ratio Set	0	1	0	0	0	1	0	0	Resistor Ratio			20h to 27h	Select internal resistor ratio Rb/Ra mode	
(18) Electronic Volume mode Set Electronic Volume Register Set	0	1	0	1	0	0	0	0	0	0	1	1	81h	
	0	1	0	*	*	Electronic Control Value					XX	Sets the V0 output voltage electronic volume register		
(19) Set Static indicator ON/OFF Set Static Indicator Register	0	1	0	1	0	1	0	1	1	0	0	1	ACh ADh	Sets static indicator ON/OFF 0: OFF, 1: ON
	0	1	0	*	*	*	*	*	*	Mode		XX	Sets the flash mode	
(20) Power Save	0	1	0	-	-	-	-	-	-	-	-	-	-	Compound command of Display OFF and Entire Display ON
(21) NOP	0	1	0	1	1	1	0	0	0	1	1	1	E3h	Command for non-operation



## AQM1264C-FL-YBW GRAPHIC MODULE VER1.0

Command	A0	/RD	/WR	Code								Hex	Function	
				D7	D6	D5	D4	D3	D2	D1	D0			
(22)Oscillation Frequency Select	0	1	0	1	1	1	0	0	1	0	0	1	E4h E5h	Select the oscillation frequency
(23)Partial Display mode Set	0	1	0	1	0	0	0	0	0	1	0	1	82h 83h	Enter/Release the partial display mode
(24)Partial Display Duty Set	0	1	0	0	0	1	1	0	Duty Ratio			30h 37h	Sets the LCD duty ratio for partial display mode	
(25)Partial Display Bias Set	0	1	0	0	0	1	1	1	Bias Ratio			38h 3Fh	Sets the LCD bias ratio for partial display mode	
(26)Partial Start Line Set	0	1	0	1	1	0	1	0	0	1	1	D3h	Enter Partial Start Line Set	
Partial Start Line Set	0	1	0	1	1	Partial Start Line					XX	Sets the LCD Number of partial display start line		
(27)N-Line Inversion Set	0	1	0	1	0	0	0	0	1	0	1	85h	Enter N-Line inversion	
Number of Line Set	0	1	0	*	*	*	Number of Line					XX	Sets the number of line used for N-Line inversion	
(28)N-Line Inversion Release	0	1	0	1	0	0	0	0	1	0	0	84h	Exit N-Line Inversion	
(29)DC/DC Clock Set	0	1	0	1	1	1	0	0	1	1	0	E6h	Set DC/DC Clock Frequency	
DC/DC Clock Division Set	0	1	0	1	1	0	0	Clock Division			XX	Set the Division of DC/DC Clock Frequency		
(30)Test Command	0	1	0	1	1	1	1	*	*	*	*	F1h to FFh	IC test command. Do not use!	
(31)Test Mode Reset	0	1	0	1	1	1	1	0	0	0	0	F0h	Command of test mode reset	

Note: Do not use any other command, or system malfunction may result.

### 11.0 RELIABILITY SPECIFICATION

ITEM	CONDCONDITIONS
High temperature operation	70°C for 96 hours
Low temperature operation	-20°C for 96 hours
High humidity, High temperature operation	40°C,90%RH for 96 hours
High temperature storage	80°C for 96 hours
Low temperature storage	-30°C for 96 hours
Temperature cycling(storage)	80°C (30 min) ↓ ↑ 25°C ( 5 min) ↓ ↑ -30°C ( 30 min) CYCLES: 5
ESD (Electrostatic Discharge)	+/-8KV air discharge to LCD module. +/-2KV discharge is applied to VDD&VSS of LCD module. Test for functionality and No missing line after discharge.