

AZ DISPLAYS

SPECIFICATIONS FOR LIQUID CRYSTAL DISPLAY

CUSTOMER APPROVAL			
※ PART NO. : AQM1264PA-NLW-BBW (AZ DISPLAYS) VER2.0			
APPROVAL		COMPANY CHOP	
CUSTOMER COMMENTS			

AZ DISPLAYS ENGINEERING APPROVAL		
DESIGNED BY	CHECKED BY	APPROVED BY
BOBBY	JAY	GUZHENGHUA

REVISION RECORD

REVISION	REVISION DATE	PAGE	CONTENTS
VER1.0	25/11-2010		FIRST ISSUE
VER2.0	12/01-2011	10	MODIFY LCD PIN LENGTH TO 7.0MM

※ **CONTENTS**

- 1.0 GENERAL SPECIFICATION
- 2.0 ABSOLUTE MAXIMUM RATINGS
- 3.0 ELECTRICAL CHARACTERISTICS
- 4.0 OPTICAL CHARACTERISTICS
- 5.0 BLOCK DIAGRAM
- 6.0 PIN ASSIGNMENT
- 7.0 POWER SUPPLY
- 8.0 TIMING CHARACTERISTICS
- 9.0 MECHANICAL DIAGRAM
- 10.0 RELIABILITY TEST
- 11.0 INSTRUCTION DESCRIPTION
- 12.0 PRECAUTION FOR USING LCM

1.0 GENERAL SPECS

1. Display Format	128*64 Dot matrix
2. Power Supply	3.0V
3. Module outline dimension	89.7mm(W) x 49.8mm(H) x 6.7mm(D)
4. Viewing Area(W*H)	66.8mm(W) x 35.5mm(H)
5. Dot Size (W*H)	0.48mm(W) x 0.48mm(H)
6. Dot Pitch (W*H)	0.50mm(W) x 0.50mm(H)
7. Viewing Direction	6:00 O'Clock
8. Driving Method	1/65 Duty,1/9 Bias
9. Control IC	ST7565P or compatible
10. Display Mode	STN (BLUE) /Negative/Transmissive
11. Backlight Options	White LED /Side
12. Operating temperature	-20°C ~ 70°C
13. Storage temperature	-30°C ~ 85°C
14. ROHS	ROHS compliant

2.0 ABSOLUTE MAXIMUM RATINGS

Item	Symbol	Min	Typ	Max	Unit
Operating temperature	Top	-20	-	70	°C
Storage temperature	Tst	-30	-	85	°C
Input voltage	Vin	0.3	-	Vdd+0.3	V
Supply voltage for logic	Vdd- Vss	0.3	-	3.6	V
Supply voltage for LCD driving	V0-Vss	0.3		14.5	V

3.0 ELECTRICAL CHARACTERISTICS

3.1 Electrical Characteristics Of LCM

Item	Symbol	Condition	Min	Typ	Max	Unit
Power Supply Voltage	VDD	Ta=25°C	2.8	3.0	3.2	V
Power Supply Current	Idd	Vdd=3.0V	--	0.7	1.0	mA
Input voltage (high)	Vih	H level	0.8*VDD	--	VDD	V
Input voltage (low)	Vil	L level	VSS	--	0.2*VDD	V
Recommended LC Driving Voltage	V0-Vss	-20°C	9.1	9.3	9.5	V
		25°C	8.7	8.9	9.1	
		70°C	8.3	8.5	8.7	

3.2 The Characteristics Of Backlight

3.2.1 Electrical-Optical Characteristics Of LED Backlight (Ta=25°C)

Item	Symbol	Condition	Min	Typ	Max	Unit
Forward Voltage ⁽¹⁾	Vf	If=45mA	2.9	3.1	3.3	V
Reverse Voltage	Vr	-	--	--	5	V
Luminance ⁽²⁾	Lv	If=45mA	200	240	--	cd/m ²
Uniformity ⁽³⁾	Δ	(Lvmin/Lvmax)%	70%	--	--	-
Peak wave length	λ p	-	--	--	--	nm
Chroma coordinate	x	If=45mA	0.26	--	0.32	um
	y	If=45mA	0.26	--	0.32	um
Lifetime ⁽⁴⁾	-	If=45mA	-	20000	-	Hours

NOTE:

- (1) Forward voltage means voltage applied directly to the LED
- (2) The luminance is the average value of 5 points, The measurement instrument is BM-7 luminance colorimeter. The diameter of aperture is Φ5mm
- (3) Luminance means the backlight brightness without LCD.
- (4) Backlight lifetime means luminance value larger than half of the original after 20000 hours' continuous working.

3.2.2 Backlight Control Circuit FOR LCM (1x3=3 pcs LED)

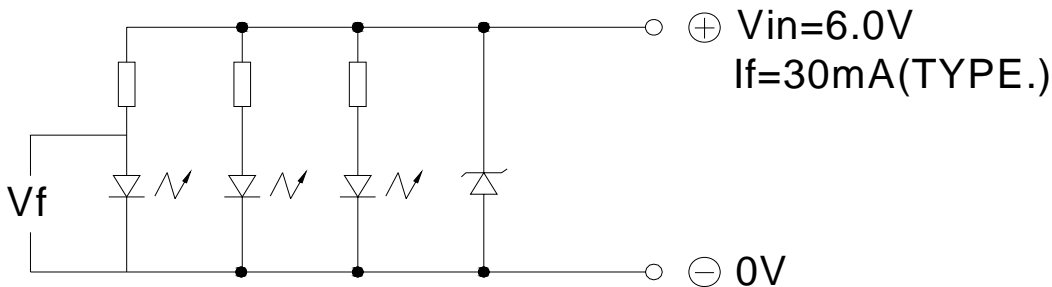

3.2.3 LED Characteristics Curves (for single led)

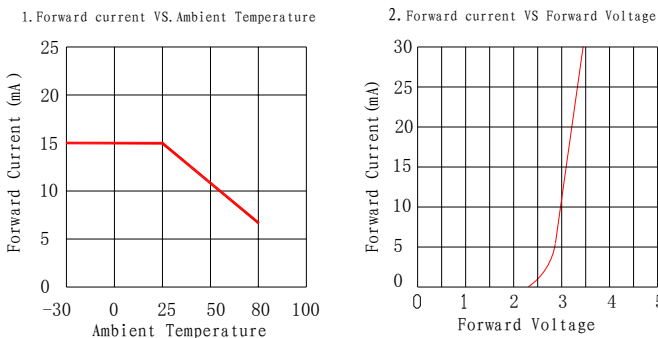

4.0 OPTICAL CHARACTERISTICS

Item	Symbol	Condition	Min	Typ	Max	Unit
Viewing angle (Left - right)	$\theta 2$	$Cr \geq 2.0$	-35	-	35	deg
Viewing angle (Up-down)	$\theta 1$	$Cr \geq 2.0$	-25	-	40	deg
Contrast Ratio	Cr	$\theta 1=0^\circ, \theta 2=0^\circ$	-	6	-	
Response time (rise)	Tr	$\theta 1=0^\circ, \theta 2=0^\circ$	-	180	300	ms
Response time (fall)	Tf	$\theta 1=0^\circ, \theta 2=0^\circ$	-	150	250	ms

(1). Definition of Optical Response Time

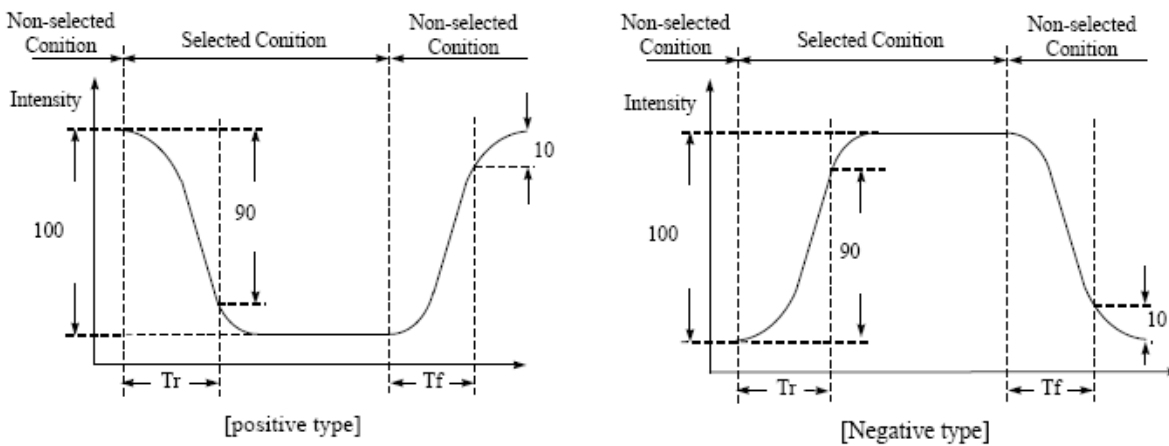

(2). Definition of Contrast Ratio

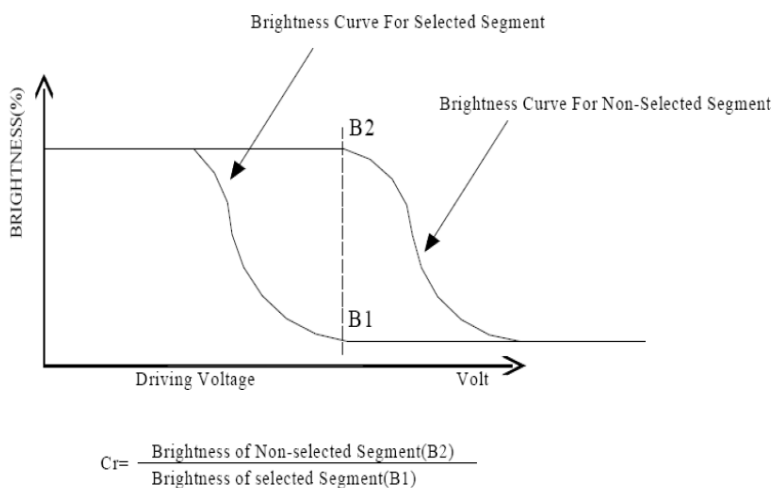

(3). Definition of Viewing Angle θ_2 and θ_1

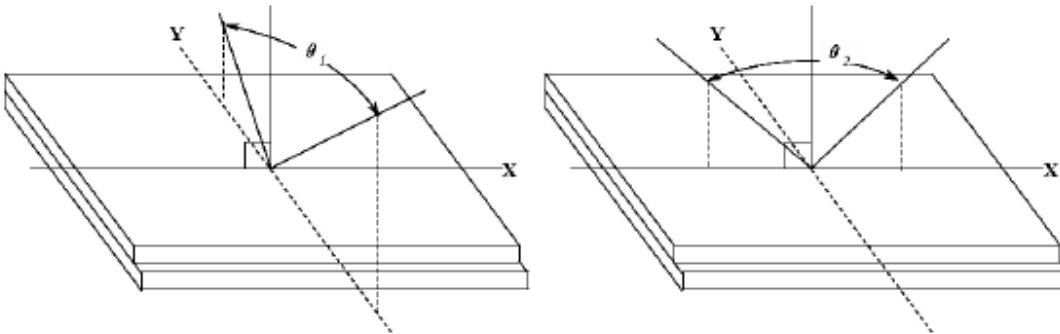

5.0 BLOCK DIAGRAM

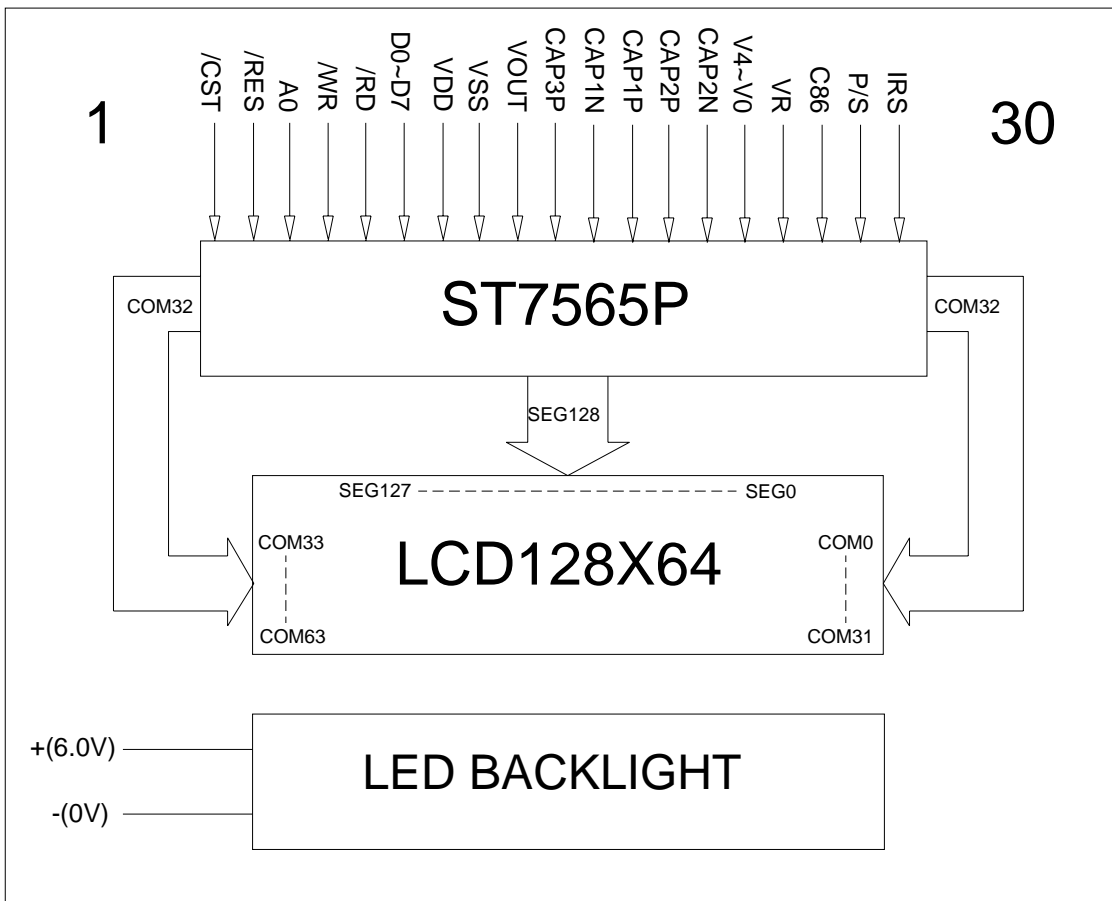

6.0 PIN ASSIGNMENT

Pin No.	Symbol	Function
1	/CST	Chip select signal
2	/RES	Reset signal
3	A0	Display/Control data select signal
4	/WR	Write signal
5	/RD	Read signal
6	D0	Data bit0
7	D1	Data bit1
8	D2	Data bit2
9	D3	Data bit3
10	D4	Data bit4
11	D5	Data bit5
12	D6	Data bit6
13	D7	Data bit7
14	VDD	Power Supply
15	VSS	Ground
16	VOUT	Voltage converter input/output pin
17	CAP3P	Capacitor 3 positive connection pin for voltage converter
18	CAP1N	Capacitor 1 negative connection pin for voltage converter
19	CAP1P	Capacitor 1 positive connection pin for voltage converter
20	CAP2P	Capacitor 2 positive connection pin for voltage converter
21	CAP2N	Capacitor 2 negative connection pin for voltage converter
22	V4	LCD driver supply voltages. The voltage determined by LCD pixel is impedance-converted by an operational amplifier for application Voltages should have the following relationship: $V0 \cong V1 \cong V2 \cong V3 \cong V4 \cong Vss$
23	V3	
24	V2	
25	V1	
26	V0	
27	VR	Output voltage regulator terminal
28	C86	MPU interface selection signal
29	P/S	Parallel or Serial data select signal
30	IRS	This terminal selects the resistors for the V0 voltage level adjustment

7.0 POWER SUPPLY

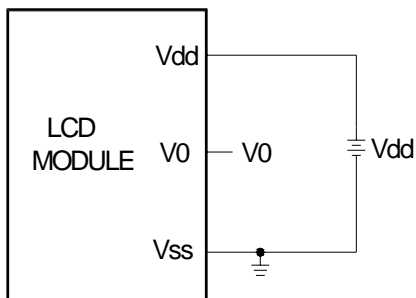

8.0 TIMING CHARACTERISTICS

System Bus Read/Write Characteristics 1 (For the 8080 Series MPU)

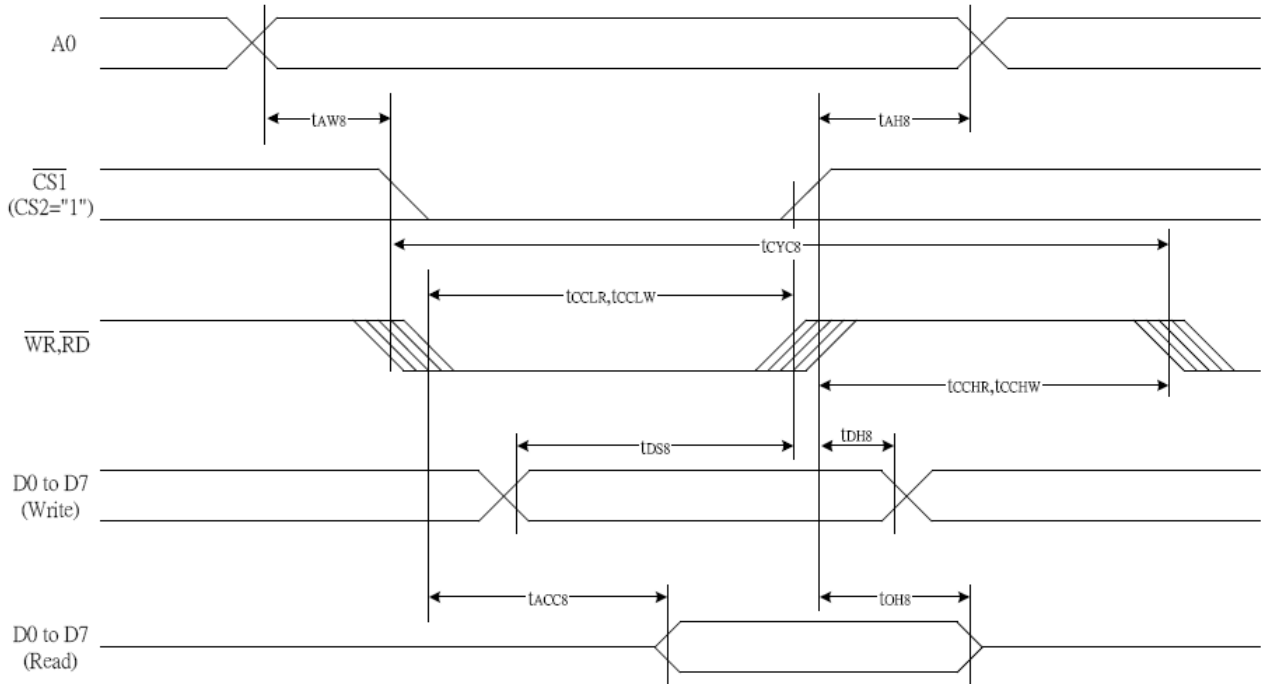

Figure 37

Table 24

(VDD = 3.3V, Ta = -30 to 85°C)

Item	Signal	Symbol	Condition	Rating		Units
				Min.	Max.	
Address hold time	A0	tAH8		0	—	Ns
Address setup time		tAW8		0	—	
System cycle time		tCYC8		240	—	
Enable L pulse width (WRITE)	WR	tCCLW		80	—	
Enable H pulse width (WRITE)		tCCHW		80	—	
Enable L pulse width (READ)	RD	tCCLR		140	—	
Enable H pulse width (READ)		tCCHR		80	—	
WRITE Data setup time	D0 to D7	tDS8		40	—	
WRITE Address hold time		tDH8		0	—	
READ access time		tACC8	CL = 100 pF	—	70	
READ Output disable time		tOH8	CL = 100 pF	5	50	

AQM1264PA-NLW-BBW (AZ DISPLAYS) GRAPHIC MODULE VER2.0

Table 25

(V_{DD} = 2.7V, T_a = -30 to 85°C)

Item	Signal	Symbol	Condition	Rating		Units
				Min.	Max.	
Address hold time	A0	t _{AH8}		0	—	ns
Address setup time		t _{AW8}		0	—	
System cycle time		t _{CYC8}		400	—	
Enable L pulse width (WRITE)	WR	t _{CCLW}		220	—	
Enable H pulse width (WRITE)		t _{CCHW}		180	—	
Enable L pulse width (READ)	RD	t _{CCLR}		220	—	
Enable H pulse width (READ)		t _{CCHR}		180	—	
WRITE Data setup time	D0 to D7	t _{DS8}		40	—	
WRITE Address hold time		t _{DH8}		0	—	
READ access time		t _{ACC8}	CL = 100 pF	—	140	
READ Output disable time		t _{OH8}	CL = 100 pF	10	100	

Table 26

(V_{DD} = 1.8V, T_a = -30 to 85°C)

Item	Signal	Symbol	Condition	Rating		Units
				Min.	Max.	
Address hold time	A0	t _{AH8}		0	—	ns
Address setup time		t _{AW8}		0	—	
System cycle time		t _{CYC8}		640	—	
Enable L pulse width (WRITE)	WR	t _{CCLW}		360	—	
Enable H pulse width (WRITE)		t _{CCHW}		280	—	
Enable L pulse width (READ)	RD	t _{CCLR}		360	—	
Enable H pulse width (READ)		t _{CCHR}		280	—	
WRITE Data setup time	D0 to D7	t _{DS8}		80	—	
WRITE Address hold time		t _{DH8}		0	—	
READ access time		t _{ACC8}	CL = 100 pF	—	240	
READ Output disable time		t _{OH8}	CL = 100 pF	10	200	

*1 The input signal rise time and fall time (t_r, t_f) is specified at 15 ns or less. When the system cycle time is extremely fast, (t_r + t_f) ≤ (t_{CYC8} - t_{CCLW} - t_{CCHW}) for (t_r + t_f) ≤ (t_{CYC8} - t_{CCLR} - t_{CCHR}) are specified.

*2 All timing is specified using 20% and 80% of V_{DD} as the reference.

*3 t_{CCLW} and t_{CCLR} are specified as the overlap between /CS1 being "L" (CS2 = "H") and /WR and /RD being at the "L" level.

For more details, please refer to IC specification.

AQM1264PA-NLW-BBW (AZ DISPLAYS) GRAPHIC MODULE VER2.0

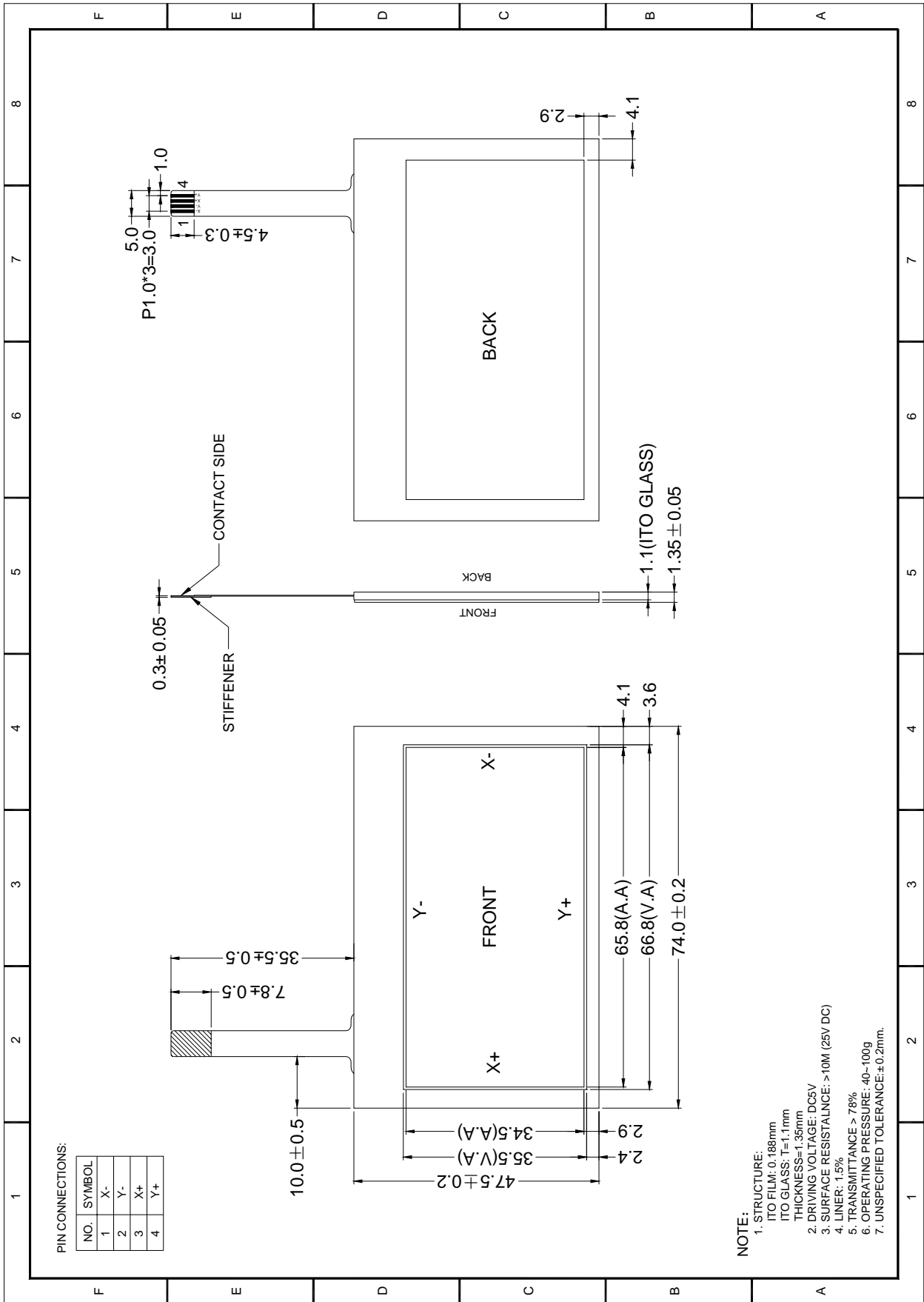

10.0 RELIABILITY TEST

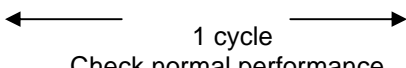
NO	Test Item	Description	Test Condition	Remark	
1	Environmental Test	High temperature storage	Applying the high storage temperature Under normal humidity for a long time Check normal performance	85 °C 96hrs	
2		Low temperature storage	Applying the low storage temperature Under normal humidity for a long time Check normal performance	-30°C 96hrs	
3		High temperature Operation	Apply the electric stress(Voltage and current) Under high temperature for a long time	70 °C 96hrs	Note1
4		Low temperature Operation	Apply the electric stress Under low temperature for a long time	-20°C 96hrs	Note1 Note2
5		High temperature/High Humidity Storage	Apply high temperature and high humidity storage for a long time	90% RH 40°C 96hrs	Note2
6		Temperature Cycle	Apply the low and high temperature cycle -30°C <> 25°C <> 85°C <> 25°C 30min 10min 30min 10min  Check normal performance	-30°C/85°C 10 cycle	
7	Mechanical Test	Vibration test(Package state)	Applying vibration to product check normal performance	Freq:10~55~10Hz Amplitude:0.75mm 1 cycle time:1min X.Y.Z every direction for 15 cycles	
8		Shock test(package state)	Applying shock to product check normal performance	Drop them through 70cm height to strike horizontal plane	
9	Other				

Remark

Note1:Normal operations condition (25°C±5°C).

Note2:Pay attention to keep dewdrops from the module during this test.

11.0 DISPLAY CONTROL INSTRUCTION

Command	Command Code								Function				
	A0	/RD	/WR	D7	D6	D5	D4	D3		D2	D1	D0	
(1) Display ON/OFF	0	1	0	1	0	1	0	1	1	1	0	1	LCD display ON/OFF 0: OFF, 1: ON
(2) Display start line set	0	1	0	0	1	Display start address						Sets the display RAM display start line address	
(3) Page address set	0	1	0	1	0	1	1	Page address				Sets the display RAM page address	
(4) Column address set upper bit	0	1	0	0	0	0	1	Most significant column address				Sets the most significant 4 bits of the display RAM column address.	
Column address set lower bit	0	1	0	0	0	0	0	Least significant column address				Sets the least significant 4 bits of the display RAM column address.	
(5) Status read	0	0	1	Status				0	0	0	0	0	Reads the status data
(6) Display data write	1	1	0	Write data								Writes to the display RAM	
(7) Display data read	1	0	1	Read data								Reads from the display RAM	
(8) ADC select	0	1	0	1	0	1	0	0	0	0	0	1	Sets the display RAM address SEG output correspondence 0: normal, 1: reverse
(9) Display normal/reverse	0	1	0	1	0	1	0	0	1	1	0	1	Sets the LCD display normal/reverse 0: normal, 1: reverse
(10) Display all points ON/OFF	0	1	0	1	0	1	0	0	1	0	0	1	Display all points 0: normal display 1: all points ON
(11) LCD bias set	0	1	0	1	0	1	0	0	0	1	0	1	Sets the LCD drive voltage bias ratio 0: 1/9 bias, 1: 1/7 bias (ST7565P)
(12) Read/modify/write	0	1	0	1	1	1	0	0	0	0	0	0	Column address increment At write: +1 At read: 0
(13) End	0	1	0	1	1	1	0	1	1	1	0	0	Clear read/modify/write
(14) Reset	0	1	0	1	1	1	0	0	0	0	1	0	Internal reset
(15) Common output mode select	0	1	0	1	1	0	0	0	*	*	*	*	Select COM output scan direction 0: normal direction 1: reverse direction
(16) Power control set	0	1	0	0	0	1	0	1	Operating mode			Select internal power supply operating mode	
(17) V ₀ voltage regulator internal resistor ratio set	0	1	0	0	0	1	0	0	Resistor ratio			Select internal resistor ratio(Rb/Ra) mode	
(18) Electronic volume mode set	0	1	0	1	0	0	0	0	0	0	0	1	Set the V ₀ output voltage electronic volume register
Electronic volume register set				0	0	Electronic volume value							
(19) Static indicator ON/OFF	0	1	0	1	0	1	0	1	1	0	0	1	0: OFF, 1: ON
Static indicator register set				0	0	0	0	0	0	0	0	0	Mode
(20) Booster ratio set	0	1	0	1	1	1	1	1	0	0	0	0	select booster ratio 00: 2x,3x,4x 01: 5x 11: 6x
(21) Power saver													Display OFF and display all points ON compound command
(22) NOP	0	1	0	1	1	1	0	0	0	0	1	1	Command for non-operation
(23) Test	0	1	0	1	1	1	1	*	*	*	*	*	Command for IC test. Do not use this command

12.0 PRECAUTION FOR USING LCM

1. When design the product with this LCD Module, make sure the viewing angle matches to its purpose of usage.
2. As LCD panel is made of glass substrate, Dropping the LCD module or banging it against hard objects may cause cracking or fragmentation. Especially at corners and edges.
3. Although the polarizer of this LCD Module has the anti-glare coating, always be careful not to scratch its surface. Use of a plastic cover is recommended to protect the surface of polarizer.
4. If the LCD module is stored at below specified temperature, the LC material may freeze and be deteriorated. If it is stored at above specified temperature, the molecular orientation of the LC material may change to Liquid state and it may not revert to its original state. Excessive temperature and humidity could cause polarizer peel off or bubble. Therefore, the LCD module should always be stored within specified temperature range.
5. Saliva or water droplets must be wiped off immediately as those may leave stains or cause color changes if remained for a long time. Water vapor will cause corrosion of ITO electrodes.
6. If the surface of LCD panel needs to be cleaned, wipe it swiftly with cotton or other soft cloth. If it is not still clean enough, blow a breath on the surface and wipe again.
7. The module should be driven according to the specified ratings to avoid malfunction and permanent damage.
Applying DC voltage cause a rapid deterioration of LC material. Make sure to apply alternating waveform by continuous application of the M signal. Especially the power ON/OFF sequence should be kept to avoid latchup of driver LSIs and DC charge up to LCD panel.
8. Mechanical Considerations
 - a) LCM are assembled and adjusted with a high degree of precision. Avoid excessive shocks and do not make any alterations or modifications. The following should be noted.
 - b) Do not tamper in any way with the tabs on the metal frame.
 - c) Do not modify the PCB by drilling extra holes, changing its outline, moving its components or modifying its pattern.
 - d) Do not touch the elastomer connector; especially insert a backlight panel (for example, EL).
 - e) When mounting a LCM makes sure that the PCB is not under any stress such as bending or twisting.
Elastomer contacts are very delicate and missing pixels could result from slight dislocation of any of the elements.
 - f) Avoid pressing on the metal bezel, otherwise the elastomer connector could be deformed and lose contact, resulting in missing pixels.
9. Static Electricity
 - a) Operator
Wear the electrostatics shielded clothes because human body may be statically charged if not wear shielded clothes. Never touch any of the conductive parts such as the LSI pads; the copper leads on the PCB and the interface terminals with any parts of the human body.
 - b) Equipment
There is a possibility that the static electricity is charged to the equipment, which has a function of peeling or friction action (ex: conveyer, soldering iron, working table). Earth the equipment through proper resistance (electrostatic earth: 1x10⁸ ohm).

Only properly grounded soldering irons should be used.

If an electric screwdriver is used, it should be well grounded and shielded from commutator sparks.

The normal static prevention measures should be observed for work clothes and working benches; for the latter conductive (rubber) mat is recommended.

c) Floor

Floor is the important part to drain static electricity, which is generated by operators or equipment.

There is a possibility that charged static electricity is not properly drained in case of insulating floor. Set the electrostatic earth (electrostatic earth: 1×10^8 ohm).

d) Humidity

Proper humidity helps in reducing the chance of generating electrostatic charges. Humidity should be kept over 50%RH.

e) Transportation/storage

The storage materials also need to be anti-static treated because there is a possibility that the human body or storage materials such as containers may be statically charged by friction or peeling.

The modules should be kept in antistatic bags or other containers resistant to static for storage.

f) Soldering

Solder only to the I/O terminals. Use only soldering irons with proper grounding and no leakage.

Soldering temperature : $280^{\circ} \text{C} \pm 10^{\circ} \text{C}$

Soldering time: 3 to 4 sec.

Use eutectic solder with resin flux fill.

If flux is used, the LCD surface should be covered to avoid flux spatters. Flux residue should be removed afterwards.

g) Others

The laminator (protective film) is attached on the surface of LCD panel to prevent it from scratches or stains. It should be peeled off slowly using static eliminator.

Static eliminator should also be installed to the workbench to prevent LCD module from static charge.

10. Operation

a) Driving voltage should be kept within specified range; excess voltage shortens display life.

b) Response time increases with decrease in temperature.

c) Display may turn black or dark blue at temperatures above its operational range; this is (however not pressing on the viewing area) may cause the segments to appear "fractured".

d) Mechanical disturbance during operation (such as pressing on the viewing area) may cause the segments to appear "fractured".

11. If any fluid leaks out of a damaged glass cell, wash off any human part that comes into contact with soap and water. The toxicity is extremely low but caution should be exercised at all the time.

12. Disassembling the LCD module can cause permanent damage and it should be strictly avoided.

13. LCD retains the display pattern when it is applied for long time (Image retention). To prevent image retention, do not apply the fixed pattern for a long time. Image retention is not a deterioration of LCD. It will be removed after display pattern is changed.

14. Do not use any materials, which emit gas from epoxy resin (hardener for amine) and silicone adhesive agent

AQM1264PA-NLW-BBW (AZ DISPLAYS) GRAPHIC MODULE VER2.0

(dealcohol or deoxym) to prevent discoloration of polarizer due to gas.

15. Avoid the exposure of the module to the direct sunlight or strong ultraviolet light for a long time.
16. The brightness of LCD module may be affected by the routing of CCFL cables due to leakage to the chassis through coupling effect. The inverter circuit needs to be designed taking the level of leakage current into consideration. Thorough evaluation is needed for LCD module and inverter built into its host equipment to ensure specified brightness.