

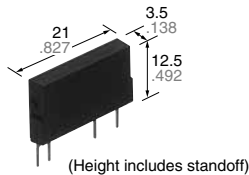

**Slim and high capacity  
up to 3.6A  
Voltage-driven type**

**PhotoMOS®  
Power 1 Form A**  
Voltage-sensitive (AQZ100D, 200D)



mm inch

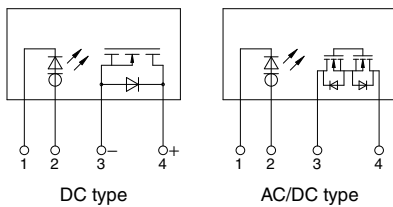

**RoHS compliant**

### FEATURES

#### 1. A voltage-sensitive power PhotoMOS

Conventional power PhotoMOS are connected externally to an input limiting resistor in order to obtain the appropriate LED current. Adding an internal constant-current element renders the input limiting resistor unnecessary, making it possible for the PhotoMOS to be voltage-driven.

#### 2. Wide range of input voltages

Allows a wide range of input voltages from 4 to 30 V DC. The PhotoMOS can be used in 5 V, 12 V or 24 V DC systems.

#### 3. Both AC/DC dual types and DC-only types available

The AC/DC dual type is capable of bi-directional control, and unlike conventional SSRs, does not have to be used differently depending on the load. The DC-only type is well suited for control of DC solenoids and DC motors.

#### 4. High capacity

Supports the various types of load control, from very small loads to a max. 2.7 A for the AC/DC dual type, max. 3.6 A for the DC-only type.

#### 5. High sensitivity and low on-resistance

Max. 3.6 A load can be controlled with the min. input voltage of 4 V DC. The on-resistance is also low at Typ. 0.033 Ω (AQZ102D).

#### 6. Slim SIL4-pin package

(W) 3.5 × (D) 21.0 × (H) 12.5 mm  
(W) .138 × (D) .827 × (H) .492 inch

The compact size of the 4-pin SIL package allows high density mounting.

### TYPICAL APPLICATIONS

- Industrial machines
- Traffic signals

### TYPES

#### 1. DC type

	Output rating*		Package	Part No.	Packing quantity	
	Load voltage	Load current			Inner carton	Outer carton
DC only	60 V	3.6 A	SIL4-pin	AQZ102D	25 pcs.	500 pcs.
	100 V	2.3 A		AQZ105D		
	200 V	1.1 A		AQZ107D		
	400 V	0.6 A		AQZ104D		

\* Load voltage and current of DC type: DC

#### 2. AC/DC type

	Output rating*		Package	Part No.	Packing quantity	
	Load voltage	Load current			Inner carton	Outer carton
AC/DC dual use	60 V	2.7 A	SIL4-pin	AQZ202D	25 pcs.	500 pcs.
	100 V	1.8 A		AQZ205D		
	200 V	0.9 A		AQZ207D		
	400 V	0.45 A		AQZ204D		

\* Load voltage and current of AC/DC type: Peak AC/DC

# Power 1 Form A Voltage-sensitive (AQZ100D, 200D)

## RATING

### 1. DC type

#### 1) Absolute maximum ratings (Ambient temperature: 25°C 77°F)

Item		Symbol	AQZ102D	AQZ105D	AQZ107D	AQZ104D	Remarks
Input	Input voltage	$V_{IN}$	30 V				
	Input reverse voltage	$V_{RIN}$	5 V				
	Power dissipation	$P_{in}$	300 mW				
Output	Load voltage (DC)	$V_L$	60 V	100 V	200 V	400 V	
	Continuous load current (DC)	$I_L$	3.6 A	2.3 A	1.1 A	0.6 A	
	Peak load current	$I_{peak}$	9.0 A	6.0 A	3.0 A	1.5 A	100 ms (1 shot), $V_L = DC$
	Power dissipation	$P_{out}$	1.35 W				
Total power dissipation		$P_T$	1.35 W				
I/O isolation voltage		$V_{iso}$	2,500 Vrms				
Ambient temperature	Operating	$T_{opr}$	-40 to +85°C -40 to +185°F (4 V $\leq V_{IN} \leq$ 6 V) -40 to +75°C -40 to +167°F (6 V < $V_{IN} \leq$ 15 V) -40 to +60°C -40 to +140°F (15 V < $V_{IN} \leq$ 30 V)				(Non-icing at low temperatures)
	Storage	$T_{stg}$	-40 to +100°C -40 to +212°F				

#### 2) Electrical characteristics (Ambient temperature: 25°C 77°F)

Item		Symbol	AQZ102D	AQZ105D	AQZ107D	AQZ104D	Condition
Input	Operate voltage	Typical	1.4 V				$I_L = 100$ mA $V_L = 10$ V
		Maximum	4 V				
	Turn off voltage	Minimum	0.8 V				$I_L = 100$ mA $V_L = 10$ V
Typical		1.3 V					
Input current		Typical	6.5 mA				$V_{IN} = 5$ V
Output	On resistance	Typical	0.033 $\Omega$	0.090 $\Omega$	0.33 $\Omega$	1.23 $\Omega$	$V_{IN} = 5$ V $I_L = Max.$ Within 1 s
		Maximum	0.09 $\Omega$	0.17 $\Omega$	0.55 $\Omega$	1.6 $\Omega$	
Off state leakage current		Maximum	10 $\mu$ A				$V_{IN} = 0$ V $V_L = Max.$
Transfer characteristics	Turn on time*	Typical	3.3 ms	2.2 ms	1.5 ms	1.2 ms	$V_{IN} = 5$ V $I_L = 100$ mA $V_L = 10$ V
		Maximum	10.0 ms				
	Turn off time*	Typical	0.2 ms		0.1 ms		$V_{IN} = 5$ V $I_L = 100$ mA $V_L = 10$ V
		Maximum	3.0 ms				
	I/O capacitance	Typical	0.8 pF				$f = 1$ MHz $V_B = 0$ V
		Maximum	1.5 pF				
Initial I/O isolation resistance		Minimum	1,000 M $\Omega$				500 V DC
Max. operating frequency		Maximum	0.5 cps				$V_{IN} = 5$ V Duty factor = 50% $I_L = Max., V_L = Max.$

### 2. AC/DC type

#### 1) Absolute maximum ratings (Ambient temperature: 25°C 77°F)

Item		Symbol	AQZ202D	AQZ205D	AQZ207D	AQZ204D	Remarks
Input	Input voltage	$V_{IN}$	30 V				
	Input reverse voltage	$V_{RIN}$	5 V				
	Power dissipation	$P_{in}$	300 mW				
Output	Load voltage (peak AC)	$V_L$	60 V	100 V	200 V	400 V	
	Continuous load current	$I_L$	2.7 A	1.8 A	0.9 A	0.45 A	Peak AC, DC
	Peak load current	$I_{peak}$	9.0 A	6.0 A	3.0 A	1.5 A	100 ms (1 shot), $V_L = DC$
	Power dissipation	$P_{out}$	1.6 W				
Total power dissipation		$P_T$	1.6 W				
I/O isolation voltage		$V_{iso}$	2,500 Vrms				
Ambient temperature	Operating	$T_{opr}$	-40 to +85°C -40 to +185°F (4 V $\leq V_{IN} \leq$ 6 V) -40 to +75°C -40 to +167°F (6 V < $V_{IN} \leq$ 15 V) -40 to +60°C -40 to +140°F (15 V < $V_{IN} \leq$ 30 V)				(Non-icing at low temperatures)
	Storage	$T_{stg}$	-40 to +100°C -40 to +212°F				

# Power 1 Form A Voltage-sensitive (AQZ100D, 200D)

## 2) Electrical characteristics (Ambient temperature: 25°C 77°F)

Item		Symbol	AQZ202D	AQZ205D	AQZ207D	AQZ204D	Condition
Input	Operate voltage	Typical	1.4 V				$I_L = 100 \text{ mA}$ $V_L = 10 \text{ V}$
		Maximum	4 V				
	Turn off voltage	Minimum	0.8 V				$I_L = 100 \text{ mA}$ $V_L = 10 \text{ V}$
		Typical	1.3 V				
Input current	Typical	6.5 mA				$V_{IN} = 5 \text{ V}$	
Output	On resistance	Typical	0.066 $\Omega$	0.180 $\Omega$	0.64 $\Omega$	2.4 $\Omega$	$V_{IN} = 5 \text{ V}$ $I_L = \text{Max.}$ Within 1 s
		Maximum	0.18 $\Omega$	0.34 $\Omega$	1.1 $\Omega$	3.2 $\Omega$	
	Off state leakage current	Maximum	10 $\mu\text{A}$				$V_{IN} = 0 \text{ V}$ $V_L = \text{Max.}$
Transfer characteristics	Turn on time*	Typical	5.8 ms	4.2 ms	2.7 ms	2.3 ms	$V_{IN} = 5 \text{ V}$ $I_L = 100 \text{ mA}$ $V_L = 10 \text{ V}$
		Maximum	10.0 ms				
	Turn off time*	Typical	0.2 ms		0.1 ms		$V_{IN} = 5 \text{ V}$ $I_L = 100 \text{ mA}$ $V_L = 10 \text{ V}$
		Maximum	3.0 ms				
	I/O capacitance	Typical	0.8 pF				$f = 1 \text{ MHz}$ $V_B = 0 \text{ V}$
		Maximum	1.5 pF				
	Initial I/O isolation resistance	Minimum	1,000 M $\Omega$				500 V DC
Max. operating frequency	Maximum	—				$V_{IN} = 5 \text{ V}$ Duty factor = 50% $I_L = \text{Max.}, V_L = \text{Max.}$	

\*Turn on/off time

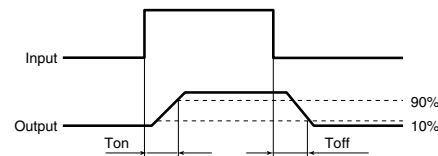

## 3. Recommended operating conditions (Ambient temperature: 25°C 77°F)

Please use under recommended operating conditions to obtain expected characteristics.

Item	Symbol	Min.	Max.	Unit	
Input voltage	$V_{IN}$	5	24	V	
AQZ102D	Load voltage (DC)	$V_L$	—	48	V
	Continuous load current (DC)	$I_L$	—	3.6	A
AQZ105D	Load voltage (DC)	$V_L$	—	80	V
	Continuous load current (DC)	$I_L$	—	2.3	A
AQZ107D	Load voltage (DC)	$V_L$	—	160	V
	Continuous load current (DC)	$I_L$	—	1.1	A
AQZ104D	Load voltage (DC)	$V_L$	—	320	V
	Continuous load current (DC)	$I_L$	—	0.6	A
AQZ202D	Load voltage (Peak AC)	$V_L$	—	48	V
	Continuous load current	$I_L$	—	2.7	A
AQZ205D	Load voltage (Peak AC)	$V_L$	—	80	V
	Continuous load current	$I_L$	—	1.8	A
AQZ207D	Load voltage (Peak AC)	$V_L$	—	160	V
	Continuous load current	$I_L$	—	0.9	A
AQZ204D	Load voltage (Peak AC)	$V_L$	—	320	V
	Continuous load current	$I_L$	—	0.45	A

■ These products are not designed for automotive use.

If you are considering to use these products for automotive applications, please contact your local Panasonic Corporation technical representative.

## REFERENCE DATA

### 1. Load current vs. ambient temperature characteristics

Allowable ambient temperature:  $-40$  to  $+85^{\circ}\text{C}$   
 $-40$  to  $+185^{\circ}\text{F}$ ;

$V_{IN}$ : Input voltage;  $I_L$  (derate): Load current (derate);  $I_L$ : Absolute maximum ratings of continuous load current

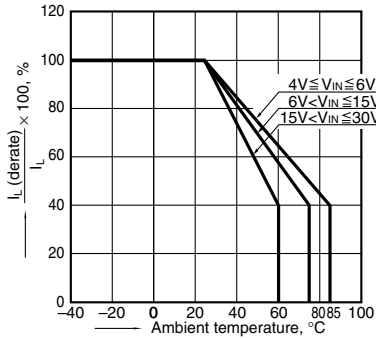

### 2.-(1) Load current vs. ambient temperature characteristics in adjacent mounting

Input voltage:  $4\text{V} \leq V_{IN} \leq 6\text{V}$ ;  
 $I_L$  (derate): Load current (derate);  $I_L$ : Absolute maximum ratings of continuous load current;  $\ell$ : Adjacent mounting pitch

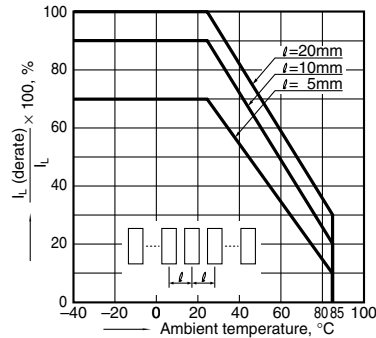

### 2.-(2) Load current vs. ambient temperature characteristics in adjacent mounting

Input voltage:  $6\text{V} < V_{IN} \leq 15\text{V}$ ;  
 $I_L$  (derate): Load current (derate);  $I_L$ : Absolute maximum ratings of continuous load current;  $\ell$ : Adjacent mounting pitch

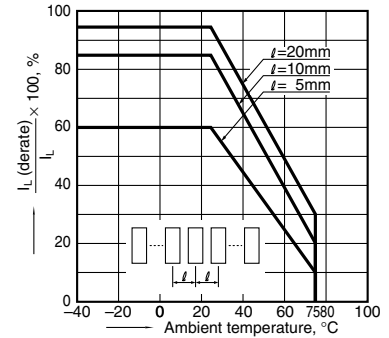

### 2.-(3) Load current vs. ambient temperature characteristics in adjacent mounting

Input voltage:  $15\text{V} < V_{IN} \leq 30\text{V}$ ;  
 $I_L$  (derate): Load current (derate);  $I_L$ : Absolute maximum ratings of continuous load current;  $\ell$ : Adjacent mounting pitch

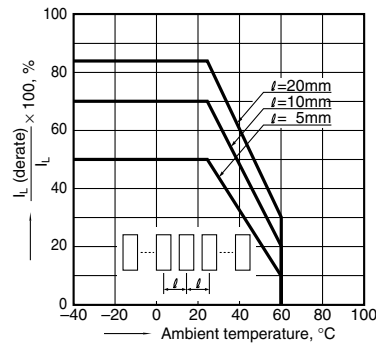

### 3.-(1) On resistance vs. ambient temperature characteristics (DC type)

Input voltage: 5 V;  
 Continuous load current: 3.6 A (DC) (AQZ102D)  
 2.3 A (DC) (AQZ105D)

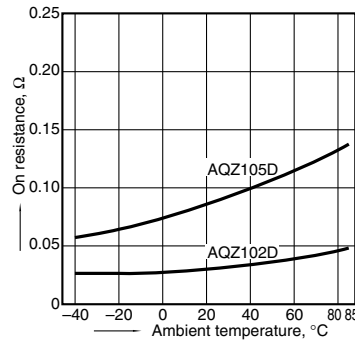

### 3.-(2) On resistance vs. ambient temperature characteristics (DC type)

Input voltage: 5 V;  
 Continuous load current: 1.1 A (DC) (AQZ107D)  
 0.6 A (DC) (AQZ104D)

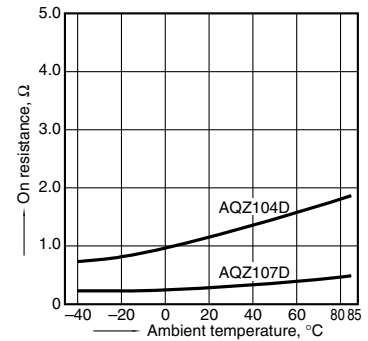

### 3.-(3) On resistance vs. ambient temperature characteristics (AC/DC type)

Input voltage: 5 V;  
 Continuous load current: 2.7 A (DC) (AQZ202D)  
 1.8 A (DC) (AQZ205D)

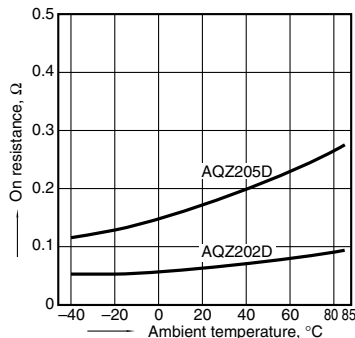

### 3.-(4) On resistance vs. ambient temperature characteristics (AC/DC type)

Input voltage: 5 V;  
 Continuous load current: 0.9 A (DC) (AQZ207D)  
 0.45 A (DC) (AQZ204D)

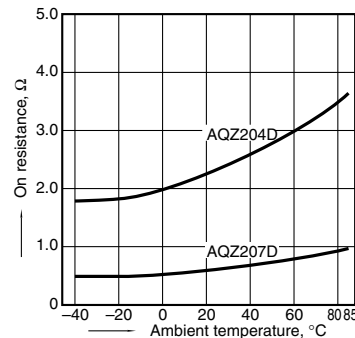

### 4.-(1) Turn on time vs. ambient temperature characteristics (DC type)

Input voltage: 5 V; Load voltage: 10 V (DC);  
 Continuous load current: 100 mA (DC)

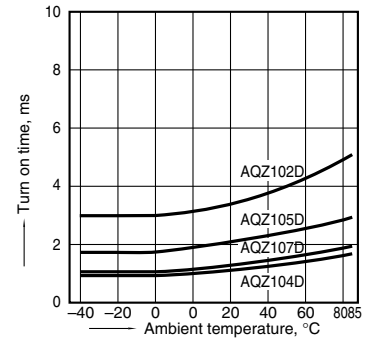

4.-(2) Turn on time vs. ambient temperature characteristics (AC/DC type)

Input voltage: 5 V;  
Load voltage: 10 V (DC);  
Continuous load current: 100 mA (DC)

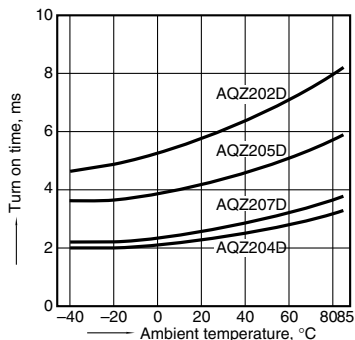

5.-(1) Turn off time vs. ambient temperature characteristics (DC type)

Input voltage: 5 V; Load voltage: 10 V (DC);  
Continuous load current: 100 mA (DC)

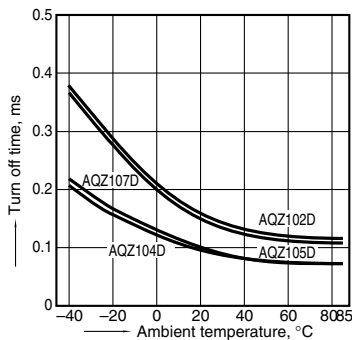

5.-(2) Turn off time vs. ambient temperature characteristics (AC/DC type)

Input voltage: 5 V; Load voltage: 10 V (DC);  
Continuous load current: 100 mA (DC)

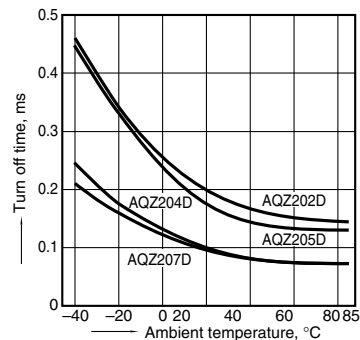

6. Operate voltage vs. ambient temperature characteristics

Load voltage: 10 V (DC);  
Continuous load current: 100 mA (DC)

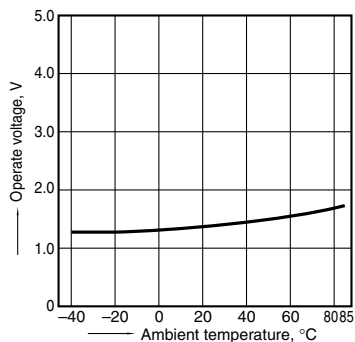

7. Turn off voltage vs. ambient temperature characteristics

Load voltage: 10 V (DC);  
Continuous load current: 100 mA (DC)

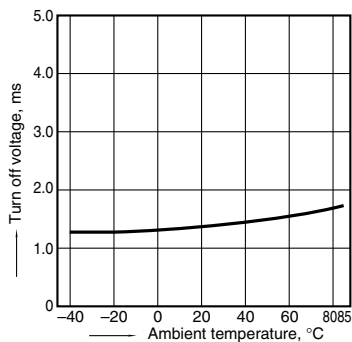

8. Input current vs. ambient temperature characteristics

Input voltage: 5 V

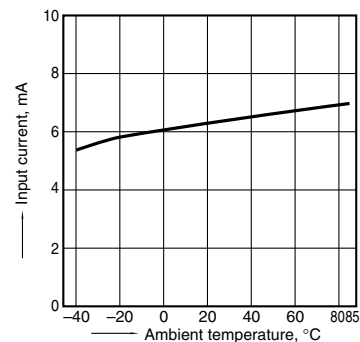

9.-(1) Current vs. voltage characteristics of output at MOS portion (DC type)

Ambient temperature: 25°C 77°F

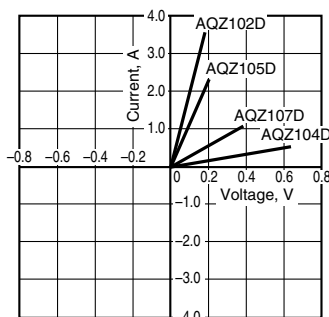

9.-(2) Current vs. voltage characteristics of output at MOS portion (AC/DC type)

Ambient temperature: 25°C 77°F

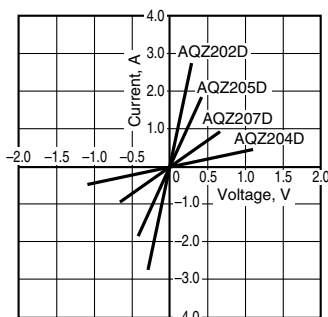

10. Input current vs. input voltage characteristics

Ambient temperature: 25°C 77°F

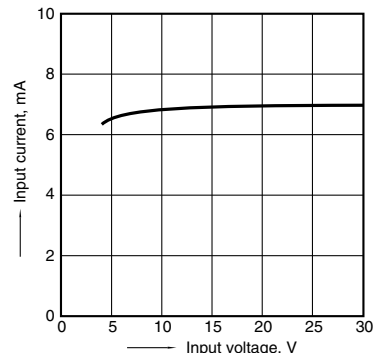

# Power 1 Form A Voltage-sensitive (AQZ100D, 200D)

11.-(1) Off state leakage current vs. load voltage characteristics  
Ambient temperature: 25°C 77°F

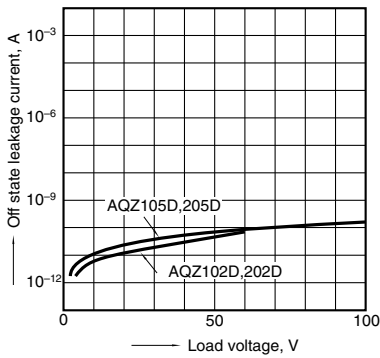

11.-(2) Off state leakage current vs. load voltage characteristics  
Ambient temperature: 25°C 77°F

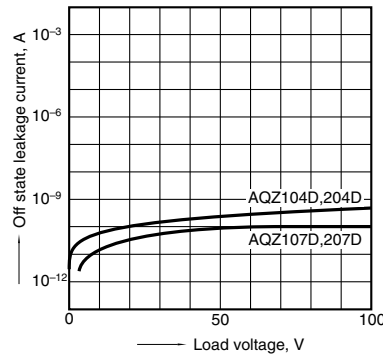

12. Max. operating frequency vs. load voltage/current characteristics  
Sample: All types; LED current: 10 mA;  
Ambient temperature: 25°C 77°F  
V<sub>L</sub>: Load voltage, V<sub>L</sub> (Max.): Max. rated load voltage  
I<sub>L</sub>: Load current, I<sub>L</sub> (Max.): Max. rated continuous load current

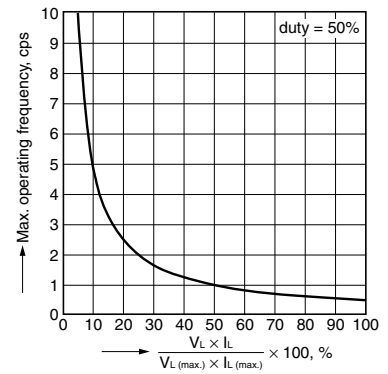

13.-(1) Output capacitance vs. applied voltage characteristics (DC type)  
Frequency: 1 MHz; Ambient temperature: 25°C 77°F

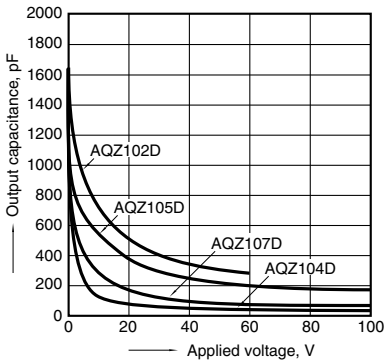

13.-(2) Output capacitance vs. applied voltage characteristics (AC/DC type)  
Frequency: 1 MHz; Ambient temperature: 25°C 77°F

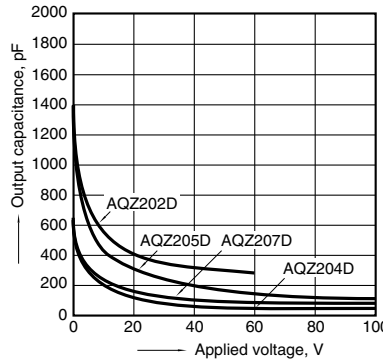

## ACCESSORY (mm inch)

### Socket

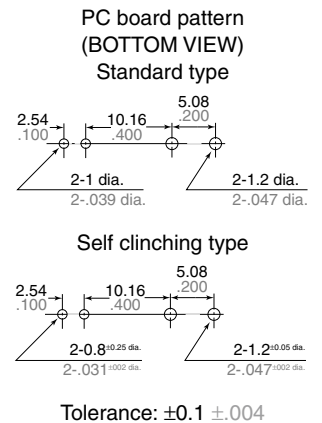
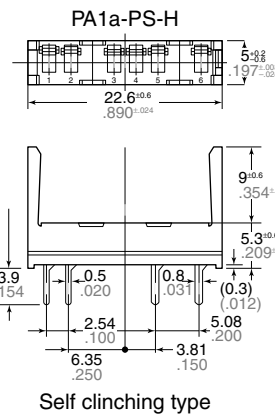
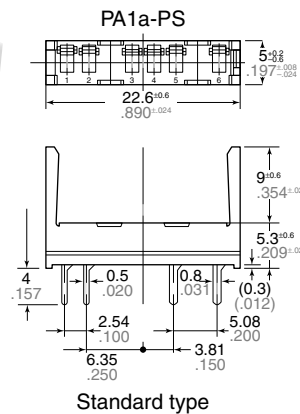

"PhotoMOS®", "PhotoMOS" and "PHOTOMOS" are registered trademarks of Panasonic Corporation.

\*Recognized in Japan, the United States, all member states of European Union and other countries.

Please contact .....

**Panasonic Corporation**

Electromechanical Control Business Division

■ 1006, Oaza Kadoma, Kadoma-shi, Osaka 571-8506, Japan  
[industrial.panasonic.com/ac/e/](http://industrial.panasonic.com/ac/e/)

**Panasonic®**

©Panasonic Corporation 2017