

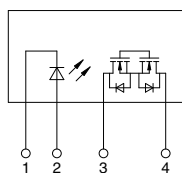

**High capacity up to 6A
in a slim SIL package**

**PhotoMOS®
Power 1 Form A
High Capacity (AQZ26○)**

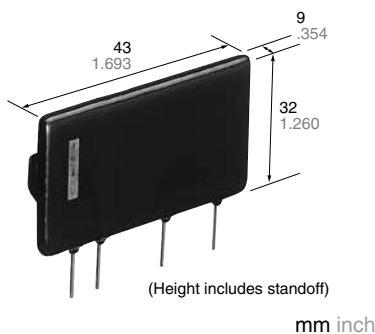

RoHS compliant

FEATURES

1. High capacity type power PhotoMOS.

Can switch a wide range of currents and voltages. Can control various types of loads, from very small loads to a max. 6A AC/DC current for sequencers, motors, and lamps.

2. Low on-resistance and high sensitivity.

Low on-resistance of less than Typ. 0.036Ω (AQZ262). High sensitivity LED operate current of Typ. 1 mA.

3. AC/DC dual use

Bi-directional control is possible. There is no need to differentiate depending on the load as was necessary with the conventional SSR.

4. 4-pin SIL type

(L) 43.0 mm × (W) 9.0 mm × (H) 32.0 mm
(L) 1.693 inch × (W) .354 inch × (H) 1.260 inch.

5. Low-level off state leakage current of max. 10 μA

6. Controls low-level analog signals

The triac, photocoupler, or SSR cannot be used to control signals of less than several hundred mV. The high capacity type power PhotoMOS feature extremely low closed-circuit offset voltage to enable control of low-level analog signals without distortion.

TYPICAL APPLICATIONS

- Mercury relay replacement
- Compact motors, lamps, heaters
- OA equipment

TYPES

	Output rating*		Package	Part No.	Packing quantity	
	Load voltage	Load current			Inner carton	Outer carton
AC/DC dual use	60 V	6.0 A	SIL4-pin	AQZ262	20 pcs	200 pcs
	400 V	1.0 A		AQZ264		

* Indicate the peak AC and DC values.

RATING

1. Absolute maximum ratings (Ambient temperature: 25°C 77°F)

Item		Symbol	AQZ262	AQZ264	Remarks
Input	LED forward current	I _F	50 mA		
	LED reverse voltage	V _R	5 V		
	Peak forward current	I _{FP}	1 A		f = 100Hz, Duty factor = 0.1%
	Power dissipation	P _{in}	75 mW		
Output	Load voltage (peak AC)	V _L	60 V	400 V	
	Continuous load current	I _L	6.0 A	1.0 A	Peak AC, DC
	Peak load current	I _{peak}	10.0 A	3.0 A	100 ms (1shot), V _L = DC
	Power dissipation	P _{out}	3.0 W		
Total power dissipation		P _T	3.0 W		
I/O isolation voltage		V _{iso}	1,500 Vrms		
Ambient temperature	Operating	T _{opr}	-40 to +85°C -40 to 185°F		(Non-icing at low temperatures)
	Storage	T _{stg}	-40 to +100°C -40 to 212°F		

Power 1 Form A High Capacity (AQZ260)

2. Electrical characteristics (Ambient temperature: 25°C 77°F)

Item		Symbol	AQZ262	AQZ264	Condition	
Input	LED operate current	Typical	1.0 mA		$I_L = 100 \text{ mA}$ $V_L = 10 \text{ V}$	
		Maximum	3.0 mA			
	LED turn off current	Minimum	0.4 mA		$I_L = 100 \text{ mA}$ $V_L = 10 \text{ V}$	
		Typical	0.9 mA			
LED dropout voltage	Typical	1.25 V (1.16 V at $I_F = 10 \text{ mA}$)			$I_F = 50 \text{ mA}$	
	Maximum	1.5 V				
Output	On resistance	Typical	0.036 Ω	1.0 Ω	$I_F = 10 \text{ mA}$ $I_L = \text{max.}$ Within 1 s	
		Maximum	0.05 Ω	1.4 Ω		
	Off state leakage current	Maximum	10 μA		$I_F = 0 \text{ mA}$ $V_L = \text{max.}$	
Transfer characteristics	Turn on time*	Typical	5 ms	4 ms	$I_F = 10 \text{ mA}$ $I_L = 100 \text{ mA}$ $V_L = 10 \text{ V}$	
		Maximum	10 ms			
	Turn off time*	Typical	0.32 ms	0.14 ms	$I_F = 10 \text{ mA}$ $I_L = 100 \text{ mA}$ $V_L = 10 \text{ V}$	
		Maximum	3.0 ms			
	I/O capacitance	Typical	2.0 pF			$f = 1 \text{ MHz}$ $V_B = 0 \text{ V}$
		Maximum	4.0 pF			
Initial I/O isolation resistance	Minimum	1,000 M Ω			500 V DC	
Max. operating frequency	Maximum	—	0.5 cps		$I_F = 10 \text{ mA}$ Duty factor = 50% $I_L = \text{Max.}, V_L = \text{Max.}$	

*Turn on/off time

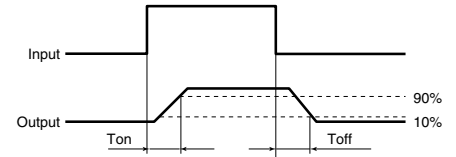

3. Recommended operating conditions (Ambient temperature: 25°C 77°F)

Please use under recommended operating conditions to obtain expected characteristics.

Item		Symbol	Min.	Max.	Unit
LED current		I_F	10	30	mA
AQZ262	Load voltage (Peak AC)	V_L	—	48	V
	Continuous load current	I_L	—	6.0	A
AQZ264	Load voltage (Peak AC)	V_L	—	320	V
	Continuous load current	I_L	—	1.0	A

■ These products are not designed for automotive use.

If you are considering to use these products for automotive applications, please contact your local Panasonic Corporation technical representative.

REFERENCE DATA

1. Load current vs. ambient temperature characteristics

Allowable ambient temperature: -40 to +85°C
-40 to +185°F

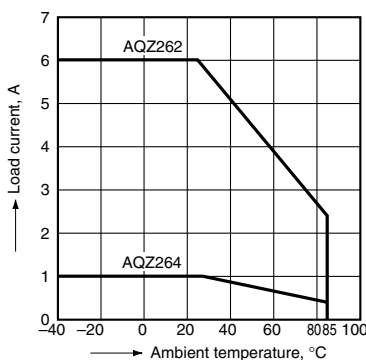

2. Load current vs. ambient temperature characteristics in adjacent mounting

I_L : Load current;
 $I_L(\text{max.})$: Maximum continuous load current

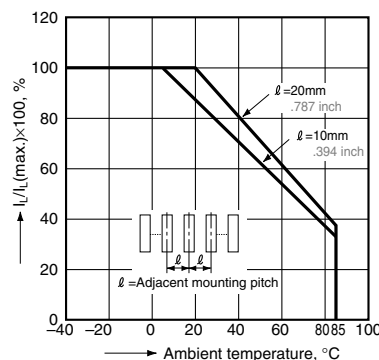

3. On resistance vs. ambient temperature characteristics

LED current: 10 mA;
Continuous load current: 6A (DC)(AQZ262)
1A (DC)(AQZ264)

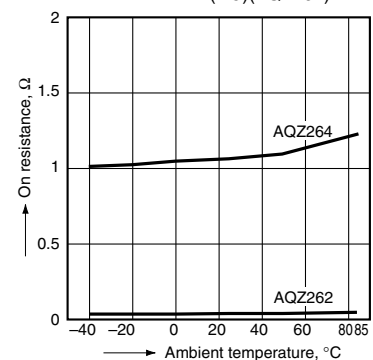

4. Turn on time vs. ambient temperature characteristics

LED current: 10 mA; Load voltage: 10 V (DC);
Continuous load current: 100 mA (DC)

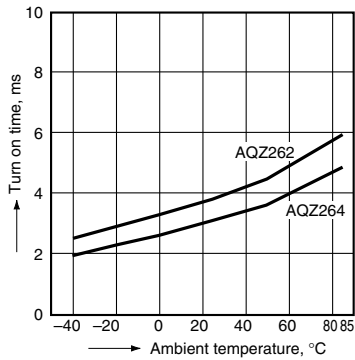

5. Turn off time vs. ambient temperature characteristics

LED current: 10 mA; Load voltage: 10 V (DC);
Continuous load current: 100 mA (DC)

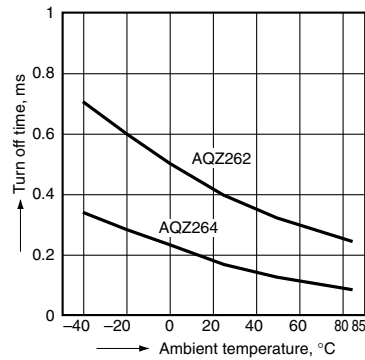

6. LED operate vs. ambient temperature characteristics

Load voltage: 10 V (DC);
Continuous load current: 100 mA (DC)

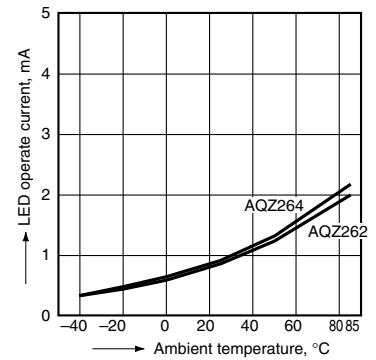

7. LED turn off current vs. ambient temperature characteristics

Load voltage: 10 V (DC);
Continuous load current: 100 mA (DC)

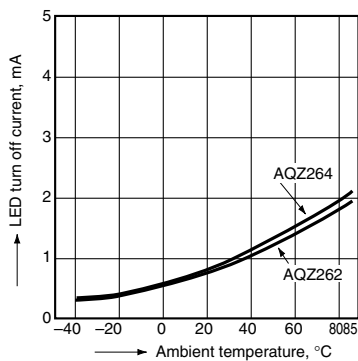

8. LED dropout voltage vs. ambient temperature characteristics

Sample: all types; LED current: 5 to 50 mA

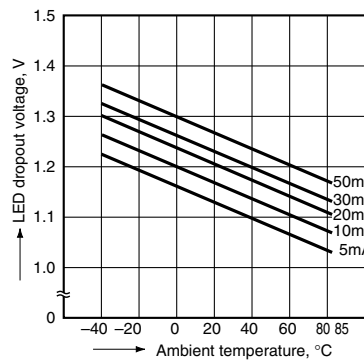

9. Current vs. voltage characteristics of output at MOS portion

Ambient temperature: 25°C 77°F

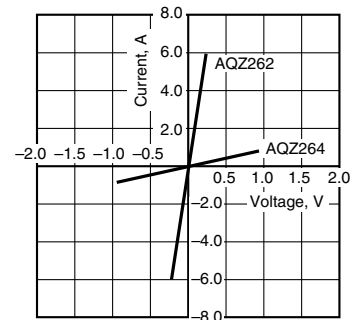

10. Off state leakage current vs. load voltage characteristics

Ambient temperature: 25°C 77°F

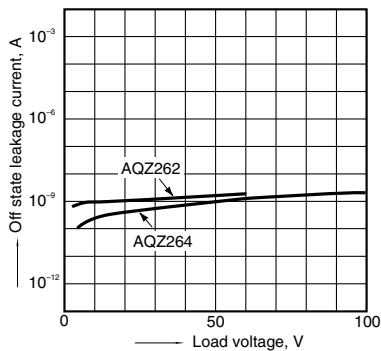

11. Turn on time vs. LED forward current characteristics

Load voltage: 10 V (DC); Continuous load current: 100 mA (DC); Ambient temperature: 25°C 77°F

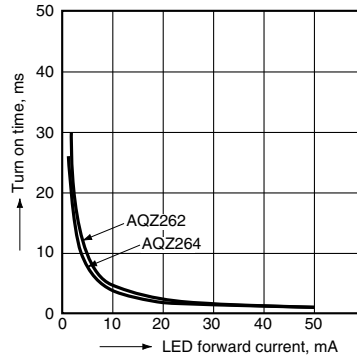

12. Turn off time vs. LED forward current characteristics

Load voltage: 10 V (DC); Continuous load current: 100 mA (DC); Ambient temperature: 25°C 77°F

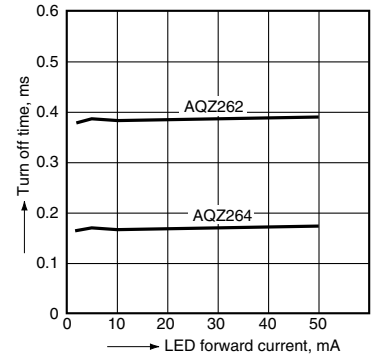

13. Max. operating frequency vs. load voltage/current characteristics

LED current: 10 mA; Ambient temperature: 25°C 77°F

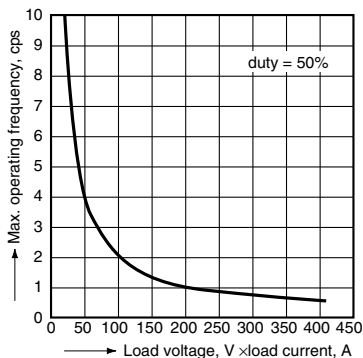

14. Output capacitance vs. applied voltage characteristics

Frequency: 10 KHz; Ambient temperature: 25°C 77°F

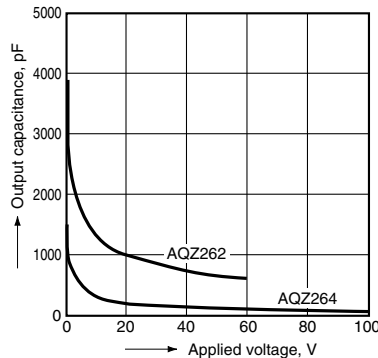

"PhotoMOS®", "PhotoMOS" and "PHOTOMOS" are registered trademarks of Panasonic Corporation.

*Recognized in Japan, the United States, all member states of European Union and other countries.

Please contact

Panasonic Corporation

Electromechanical Control Business Division

■ 1006, Oaza Kadoma, Kadoma-shi, Osaka 571-8506, Japan
industrial.panasonic.com/ac/e/

Panasonic®

©Panasonic Corporation 2017