

MODEL

AR-M161
AR-M162
AR-M165
AR-M206
AR-M207

DIGITAL MULTIFUNCTIONAL SYSTEM

OPERATION MANUAL
(for general information and copier)

Page

PART 1: GENERAL INFORMATION

- **BEFORE USING THE PRODUCT** 12
- **TROUBLESHOOTING AND MAINTENANCE** 24
- **PERIPHERAL DEVICES AND SUPPLIES** 40

PART 2: COPIER OPERATION

- **COPY FUNCTIONS** 45
- **CONVENIENT COPY FUNCTIONS** 64
- **APPENDIX** 73
- **KEY OPERATOR'S GUIDE** 75

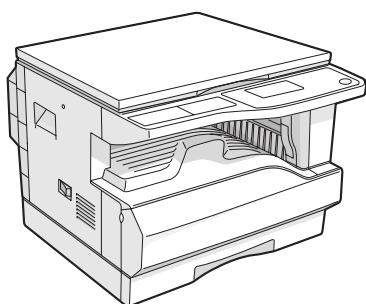

AR-M161/AR-M162/AR-M165

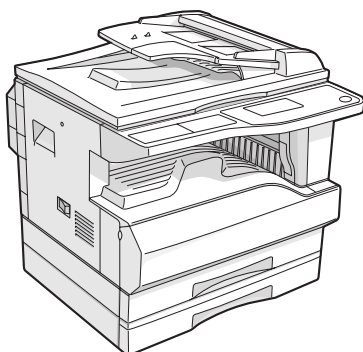

AR-M206/AR-M207
With the RSPF installed

Be sure to become thoroughly familiar with this manual to gain the maximum benefit from the product.

Before installing this product, be sure to read the cautions and installation requirements sections.

Be sure to keep all operation manuals handy for reference including this manual, the "Operation manual (for general information and copier)" and operation manuals for any optional equipment which has been installed.

In some areas, the "POWER" switch positions are marked "I" and "O" on the copier instead of "ON" and "OFF".

The symbol "O" denotes the copier is not completely de-energized but in a stand-by condition at this "POWER" switch position.

If your copier is so marked, please read "I" for "ON" and "O" for "OFF".

Caution!

For a complete electrical disconnection, pull out the main plug.



The socket-outlet shall be installed near the equipment and shall be easily accessible.

Required in IEC-950 (EN 60 950) - Europe

- The equipment should be installed near an accessible socket outlet for easy disconnection.

Required in Appendix ZB of BS 7002 (En 60 950) — United Kingdom

MAINS PLUG WIRING INSTRUCTIONS

The mains lead of this equipment is already fitted with a mains plug which is either a non-rewireable (moulded) or a rewireable type. Should the fuse need to be replaced, a BSI or ASTA approved fuse to BS1362 marked  or  and of the same rating as the one removed from the plug must be used.

Always refit the fuse cover after replacing the fuse on the moulded plug. Never use the plug without the fuse cover fitted.

In the unlikely event of the socket outlet in your home not being compatible with the plug supplied either cut-off the moulded plug (if this type is fitted) or remove by undoing the screws if a rewireable plug is fitted and fit an appropriate type observing the wiring code below.

DANGER: The fuse should be removed from the cut-off plug and the plug destroyed immediately and disposed of in a safe manner. Under no circumstances should the cut-off plug be inserted elsewhere into a 13A socket outlet as a serious electric shock may occur.

To fit an appropriate plug to the mains lead, follow the instructions below:

IMPORTANT: The wires in this mains lead are coloured in accordance with the following code:

GREEN-AND-YELLOW:	Earth
BLUE:	Neutral
BROWN:	Live

As the colours of the wires in this mains lead may not correspond with coloured markings identifying the terminals in your plug, proceed as follows:

The wire which is coloured **GREEN-AND YELLOW** must be connected to the terminal in the plug which is marked with the letter **E**, or by the safety earth symbol , or coloured green or green-and-yellow.

The wire which is coloured **BLUE** must be connected to the terminal which is marked with the letter **N** or coloured black.

The wire which is coloured **BROWN** must be connected to the terminal which is marked with the letter **L** or coloured red.

If you have any doubt, consult a qualified electrician.

WARNING: THIS APPARATUS MUST BE EARTHED.

Warning:

This is a Class A product. In a domestic environment this product may cause radio interference in which case the user may be required to take adequate measures.

Warranty

While every effort has been made to make this document as accurate and helpful as possible, SHARP Corporation makes no warranty of any kind with regard to its content. All information included herein is subject to change without notice. SHARP is not responsible for any loss or damages, direct or indirect, arising from or related to the use of this operation manual.

© Copyright SHARP Corporation 2004. All rights reserved. Reproduction, adaptation or translation without prior written permission is prohibited, except as allowed under copyright laws.

Part 1: General Information

Notes

- Considerable care has been taken in preparing this manual. If you have any comments or concerns about the manual, please contact your nearest authorised service representative.
- This product has undergone strict quality control and inspection procedures. In the unlikely event that a defect or other problem is discovered, please contact your dealer or nearest authorised service representative.
- Aside from instances provided for by law, SHARP is not responsible for failures occurring during use of the product or its options, or failures due to incorrect operation of the product and its options, or other failures, or for any damage that occurs due to use of the product.

The "Dual function board" cited in this manual can be installed as an option in some models and is pre-installed standard in other models. For detailed information, please refer to "PERIPHERAL DEVICES AND SUPPLIES" (page 40).

The display screens, messages, and key names shown in the manual may differ from those on the actual machine due to product improvements and modifications.

PRODUCT CONFIGURATIONS

This product series consists of the models indicated below. The product configuration varies by model. The explanations and illustrations in this manual generally use the AR-M206/AR-M207 (with the optional RSPF installed).

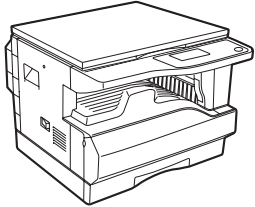
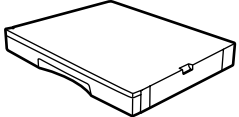
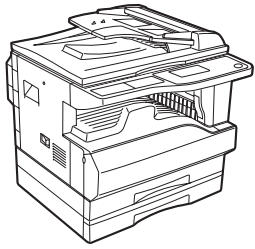
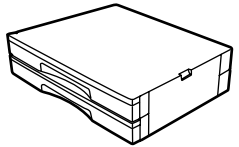
Model	Appearance	Copying speed	Paper trays	Optional trays
AR-M161 AR-M162 AR-M165		16 copies/min.	One (250 x 1)	250-sheet paper feed unit (AR-D24) 
AR-M206 AR-M207	 With the RSPF installed	20 copies/min.	Two (250 x 2)	2 x 250-sheet paper feed unit (AR-D25) 

(As of the end of October, 2004)



Some models may not be available in some countries.

CONTENTS

Part 1: General Information

PRODUCT CONFIGURATIONS	3
CAUTIONS	6
● CAUTIONS ON USING.....	6
● LASER INFORMATION	7
INSTALLATION REQUIREMENTS	8
● ENVIRONMENTAL INFORMATION.....	8
MANUALS PROVIDED WITH THE PRODUCT	9
MAIN FEATURES	10

1

BEFORE USING THE PRODUCT

PART NAMES AND FUNCTIONS	12
● OPERATION PANEL	14
● OPERATION IN COPY, PRINT, SCAN, AND FAX MODES.....	16
TURNING THE POWER ON AND OFF	17
● POWER ON	17
● POWER OFF	17
LOADING PAPER	18
● PAPER.....	18
● LOADING PAPER.....	19
● CHANGING THE PAPER SIZE SETTING OF A TRAY	21
● DISABLING (ENABLING) AUTO TRAY SWITCHING	22
AUDITING MODE	23
● NUMBER OF ACCOUNTS IN AUDITING MODE	23
● USING AUDITING MODE.....	23

2

TROUBLESHOOTING AND MAINTENANCE

TROUBLESHOOTING	25
● MACHINE/COPYING PROBLEMS.....	25
INDICATORS AND DISPLAY MESSAGES	28
REMOVING MISFEEDS	29
● ORIGINAL MISFEED IN THE SPF	29
● MISFEED IN THE BYPASS TRAY	30
● MISFEED IN THE MACHINE.....	31
● MISFEED IN TRAY 1.....	33
● MISFEED IN TRAY 2.....	34
REPLACING THE TONER CARTRIDGE	35
CHECKING THE TOTAL OUTPUT COUNT ...	36
CLEANING THE MACHINE	37
● CLEANING THE DOCUMENT GLASS AND SPF/DOCUMENT COVER.....	37
● CLEANING THE BYPASS TRAY PAPER FEED ROLLER.....	37
● CLEANING THE TRANSFER CHARGER	38
ADJUSTING THE DISPLAY CONTRAST	39

3

PERIPHERAL DEVICES AND SUPPLIES

OPTIONAL EQUIPMENT	40
● REVERSING SINGLE PASS FEEDER / SINGLE PASS FEEDER.....	41
● 250-SHEET PAPER FEED UNIT / 2 X 250-SHEET PAPER FEED UNIT	41
● DUAL FUNCTION BOARD	42
STORAGE OF SUPPLIES	42
● PROPER STORAGE	42

Part 2: Copier Operation

4 COPY FUNCTIONS

NORMAL COPYING	45
● MAKING A COPY DARKER OR LIGHTER	48
● SELECTING THE TRAY	49
● SETTING THE NUMBER OF COPIES	49
● SELECTING THE ORIGINAL SIZE	50
● USING THE BYPASS TRAY TO COPY A SPECIAL SIZE ORIGINAL.....	51
REDUCING OR ENLARGING A COPY	52
● AUTOMATIC RATIO SELECTION	52
● MANUAL RATIO SELECTION (PRESET COPY RATIOS/ZOOM).....	52
SELECTING THE VERTICAL AND HORIZONTAL COPY RATIOS SEPARATELY (XY zoom copying)	54
TWO-SIDED COPYING	56
● TWO-SIDED COPYING	56
● TWO-SIDED COPYING OF ONE-SIDED ORIGINALS	57
● TWO-SIDED COPIES OF TWO-SIDED ORIGINALS (ONLY WHEN USING THE RSPF)	59
● ONE-SIDED COPIES OF TWO-SIDED ORIGINALS (ONLY WHEN USING THE RSPF)	60
TWO-SIDED COPIES USING THE BYPASS TRAY ...	61
DUAL PAGE COPY (Dual page copy)	62
INTERRUPTING A COPY RUN (Interrupt copying)	63

5 CONVENIENT COPY FUNCTIONS

ROTATING THE IMAGE 90 DEGREES (Rotation copy)	64
SORT MODE	64
COPYING MULTIPLE ORIGINALS ONTO A SINGLE SHEET OF PAPER (2 in 1 / 4 in 1 copy)	66
CREATING MARGINS WHEN COPYING (Margin shift)	68
ERASING SHADOWS AROUND THE EDGES OF A COPY (Erase copy)	69
CARD SHOT	71

6 APPENDIX

SPECIFICATIONS	73
-----------------------------	----

7 KEY OPERATOR'S GUIDE

PURPOSE OF THE KEY OPERATOR PROGRAMS	75
● PROGRAMS RELATED TO ALL FUNCTIONS OF THE MACHINE (COPY, FAX, PRINTER, AND NETWORK SCANNER FUNCTIONS).....	75
● PROGRAMS FOR COPY MODE	75
● PROGRAMMING A KEY OPERATOR CODE ...	75
PROGRAMMING A KEY OPERATOR CODE ...	76
KEY OPERATOR PROGRAM LIST	77
USING THE KEY OPERATOR PROGRAMS ..	78
● ACCOUNT CONTROL	79
● DEVICE CONTROL.....	81
● OPERATION SETTING.....	83
● ENERGY SAVE.....	85
● COPY SETTINGS	86
MATERIAL SAFETY DATA SHEET	89
INDEX	97
KEY OPERATOR CODE NUMBER: FACTORY SETTING	103

CAUTIONS

Follow the cautions below when using this machine.

CAUTIONS ON USING

▲ Warning:

- The fusing area is hot. Exercise care in this area when removing misfed paper.
- Do not look directly at the light source. Doing so may damage your eyes.

⚠ Caution:

- Do not switch the machine rapidly on and off. After turning the machine off, wait 10 to 15 seconds before turning it back on.
- Place the machine on a firm, level surface.
- When the machine is not used for a long time, for example, during prolonged holidays, turn the power switch off and remove the power cord from the outlet.
- When moving the machine, be sure to turn the power switch off and remove the power cord from the outlet.
- Do not cover the machine with a dust cover, cloth or plastic film while the power is on. Doing so may prevent heat dissipation, damaging the machine.
- Do not make any modifications to this machine. Doing so may result in personal injury or damage to the machine.
- Do not make copies of anything which is prohibited from copying by law. The following items are normally prohibited from printing by national law. Other items may be prohibited by local law.
 - Money • Stamps • Bonds • Stocks
 - Bank drafts • Checks • Passports • Driver's licences
- Do not touch the photoconductive drum. Scratches or smudges on the drum will cause dirty prints.
- Store spare toner cartridges in a cool dry place without removing from the package before use.
- If they are exposed to direct sunlight or excessive heat, poor copies may result.

Fusing unit

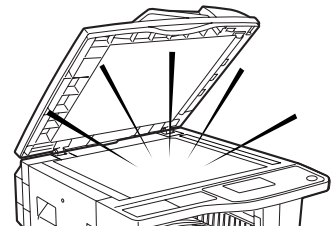
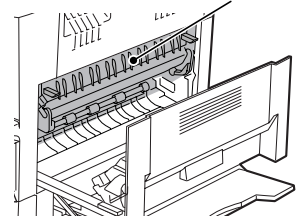

LASER INFORMATION

Wave length	785 nm + 10 nm/- 15 nm
Pulse times	(8.141 μ s \pm 0.1 μ s)/7 mm
Output power	0.14 mW - 0.22 mW

At the production line, the output power of the scanner unit is adjusted to 0.8 MILLIWATT PLUS 10 % and is maintained constant by the operation of the Automatic Power Control (APC).

Caution

Use of controls or adjustments or performance of procedures other than those specified herein may result in hazardous radiation exposure.

For North America:

SAFETY PRECAUTIONS

This Digital Equipment is rated Class 1 and complies with 21 CFR 1040.10 and 1040.11 of the CDRH standards. This means that the equipment does not produce hazardous laser radiation. For your safety, observe the precautions below.

- Do not remove the cabinet, operation panel or any other covers.
- The equipment's exterior covers contain several safety interlock switches. Do not bypass any safety interlock by inserting wedges or other items into switch slots.

For Europe:

CLASS 1 LASER PRODUCT

LASER KLASSE 1

LUOKAN 1 LASERLAITE

KLASS 1 LASERAPPARAT

CAUTION

INVISIBLE LASER RADIATION WHEN OPEN INTERLOCKS DEFEATED. AVOID EXPOSURE TO BEAM.

VORSICHT

UNSICHTBARE LASERSTRAHLUNG WENN ABDECKUNG GEÖFFNET UND SICHERHEITSVERRIEGELUNG ÜBERBRÜCKT. NICHT DEM STRAHL AUSSETZEN.

ADVARSEL

USYNLIG LASERSTRÅLNING VED ÅBNING, NÅR SIKKERHEDSBRYDERE ER UDE AF FUNKTION. UNDGÅ UDSÆTTELSE FOR STRÅLNING.

VAROITUS!

LAITTEEN KÄYTTÄMINEN MUULLA KUIN TÄSSÄ KÄYTTÖOHJEESSA MAINITULLA TAVALLA SAATTAA ALTISTAA KÄYTTÄJÄN TURVALLISUUSLUOKAN 1 YLITTÄVÄLLE NÄKYMÄTTÖMÄLLE LASERSÄTEILYLLE.

VARNING

OM APPARATEN ANVÄNDS PÅ ANNAT SÄTT ÄN I DENNA BRUKSANVISNING SPECIFICERATS, KAN ANVÄNDAREN UTSÄTTAS FÖR OSYNLIG LASERSTRÅLNING, SOM ÖVERSKRIDER GRÄNSEN FÖR LASERKLASS 1.

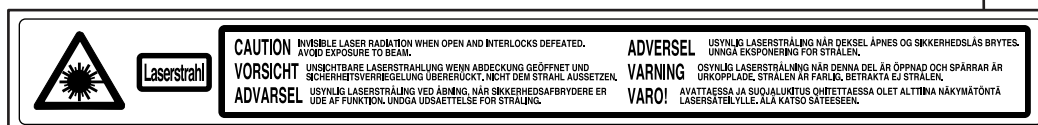
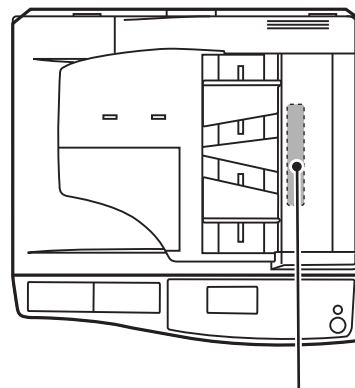
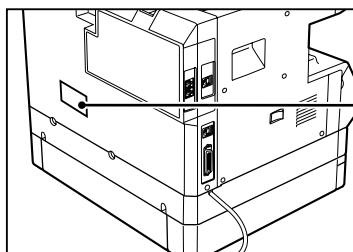

INSTALLATION REQUIREMENTS

Improper installation may damage this product. Please note the following during initial installation and whenever the machine is moved.

1. The machine should be installed near an accessible power outlet for easy connection.
2. Be sure to connect the power cord only to a power outlet that meets the specified voltage and current requirements. Also make certain the outlet is properly grounded.
 - For the power supply requirements, see the name plate on the back of the main unit.



Connect the machine to a power outlet which is not used for other electric appliances. If a lighting fixture is connected to the same outlet, the light may flicker.

3. Do not install your machine in areas that are:
 - damp, humid, or very dusty
 - exposed to direct sunlight
 - poorly ventilated
 - subject to extreme temperature or humidity changes, e.g., near an air conditioner or heater.
4. Be sure to allow the required space around the machine for servicing and proper ventilation.

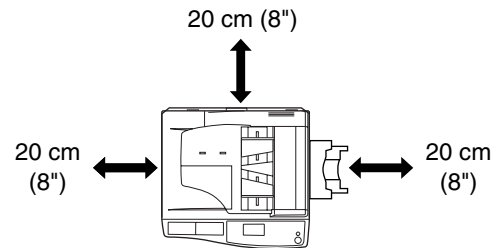

A small amount of ozone is produced within the printer during operation. The emission level is insufficient to cause any health hazard.

NOTE:

The present recommended long term exposure limit for ozone is 0.2 mg/m³ (0.1 ppm) calculated as an 8 hr. time-weighted average concentration.

However, since the small amount that is emitted may have an objectionable odor, it is advisable to place the copier in a ventilated area.

ENVIRONMENTAL INFORMATION



As an ENERGY STAR® Partner, SHARP has determined that this product meets the ENERGY STAR® guidelines for energy efficiency.

MANUALS PROVIDED WITH THE PRODUCT

Multiple manuals are provided for use of the machine. Please read each manual as appropriate for the functions that you wish to use.

Operation manual (for general information and copier) (this manual):

The first half of this manual contains general information on the machine, including safety precautions and the procedures for loading paper, removing misfeeds, and performing regular maintenance.

The second half of the manual contains explanations of how to use the copy function of the machine.

The manual also includes explanations of key operator programs for management of the machine and for the copy function. Explanations of key operator programs related to the fax, printer, and network scanner functions can be found in the respective manuals for those functions.

The key operator programs are used by the administrator of the machine to enable or disable functions to suit the needs of your workplace.

Software setup guide

This explains how to install and configure the printer driver.

Operation manual (for facsimile)*1:

This explains how to use the fax function of the machine. To use the fax function, the optional facsimile expansion kit (AR-FR11) must be installed.

Operation manual (for printer and scanner)*2:

This explains how to use the machine as a printer and a scanner when it is connected to a computer.

Operation manual (for network printer)*2:

This explains how to use the machine as a network printer.

To use the machine as a network printer, the optional network expansion kit (AR-NB3) must be installed.

Operation manual (for network scanner)*2:

This explains how to use the machine as a network scanner when it is connected to a computer. To use the machine as a network scanner, the optional network expansion kit must be installed.

*1 The "Operation manual (for facsimile)" is contained in the optional facsimile expansion kit.

*2 The "Operation manual (for printer and scanner)" is contained in the accompanying CD-ROM in PDF format. The "Operation manual (for network printer)" and the "Operation manual (for network scanner)" are contained in PDF format in the CD-ROM that accompanies the network expansion kit. (These manuals are not provided in printed form.)

The meaning of "R" in original and paper size indications

An "R" appearing at the end of an original or paper size (A4R, B5R (8-1/2" x 11"R, 5-1/2" x 8-1/2"R), etc.) indicates that the original or paper is oriented horizontally as shown below.

Sizes that can be placed only in the horizontal (landscape) orientation (A3, B4 (11" x 17", 8-1/2" x 14")) do not contain the "R" in their size indication.

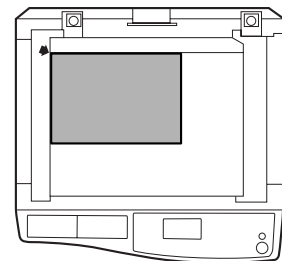

Horizontal (Landscape) orientation

Conventions used in this manual



Warns the user that injury may result if the contents of the warning are not properly followed.



Cautions the user that damage to the machine or one of its components may result if the contents of the caution are not properly followed.



Notes provide information relevant to the machine regarding specifications, functions, performance, operation and such, that may be useful to the user.

This manual refers to the Reversing single pass feeder as the "RSPF" and the single pass feeder as the "SPF". Unless specific mention is made, both the RSPF and the SPF are referred to simply as "SPF".

MAIN FEATURES

High-speed laser copying

- First-copy time*¹ at 300 dpi*² is only 7.2 seconds.
- Copying speed is 20 (AR-M206/AR-M207) or 16 (AR-M161/AR-M162/AR-M165) copies per minute. This provides a big boost to workplace productivity.

*¹ Measured after the machine has warmed up following power-on, copying using the document glass (A4 (8-1/2" x 11") paper fed from machine tray 1). The first-copy time may vary depending on machine operating conditions and ambient conditions such as temperature and power voltage.

*² "dpi" ("dots per inch") is a unit that is used to measure resolution. Resolution indicates how much detail can be reproduced in a printed or scanned image.

High-quality digital image

- High-quality copying at 600 dpi is performed.
- In addition to automatic exposure adjustment, two exposure modes can be selected: "TEXT" for text-only originals, and "PHOTO" for photographs. The exposure can be adjusted to five levels in each mode.
- Photo mode allows clear copying of originals with delicate halftones such as monochrome photos and colour photos.

Enhanced copying features

- The zoom function can be used to reduce or enlarge copies from 25% to 400% in increments of 1%. (When the SPF is used, the zoom copy ratio range is 50% to 200%.)
- Up to 999 copies can be made of an original scanned just once. (This can be changed to a maximum of 99 copies in the key operator programs.)
- The key operator programs allow functions to be selected and managed to meet your specific needs. For example, access to the machine can be controlled by enabling audit mode.
- The optional dual function board can be installed to enable use of rotation copy and other convenient functions.

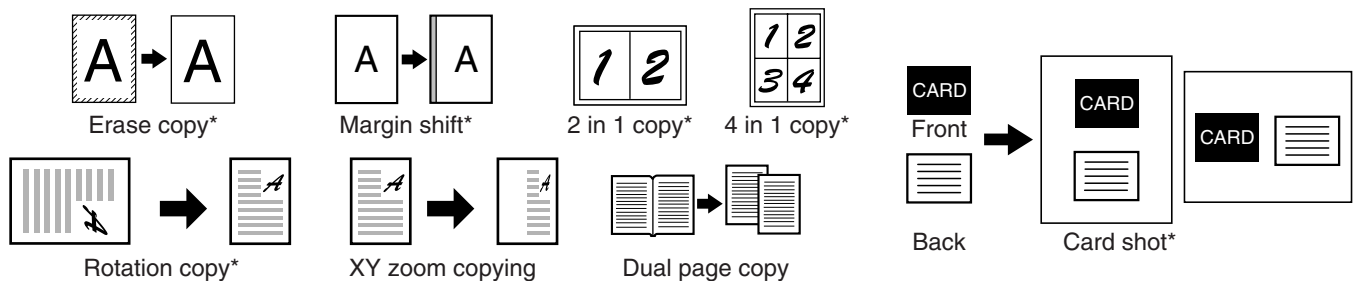

* When the dual function board is installed.

Sort function (when the dual function board is installed)

Copies of multiple original pages can be sorted into sets.

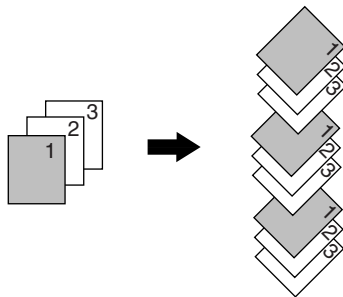

Laser printer function / colour scanner function

- The machine is equipped standard with a USB port and a parallel port. A computer can be connected to these ports to use the machine as a printer or a scanner.
- To use the machine as a printer or scanner, the printer driver or scanner driver must first be installed as explained in the "Software setup guide".
- The scanning feature is only available when the computer is connected to the USB port and is running Windows 98/Me/2000/XP. If the computer is running Windows 95/NT 4.0 or is connected to the parallel port, only printing is available.

Fax function (option)

Installation of the optional facsimile expansion kit enables the plain-paper, Super G3 laser fax function to be used.

Network connection (option)

The optional network expansion kit (AR-NB3) can be installed to enable the machine to be used as a network printer and network scanner.

Environment and people friendly design

- Preheat and auto power shut-off modes are provided to reduce power consumption when the machine is not in active use.
- A universal design has been implemented in the product whereby the height of the operation panel and shape of the keys are designed to be usable by as many people as possible.

1

BEFORE USING THE PRODUCT

This chapter contains basic information required for use of the machine. Please read this chapter before using the machine.

PART NAMES AND FUNCTIONS

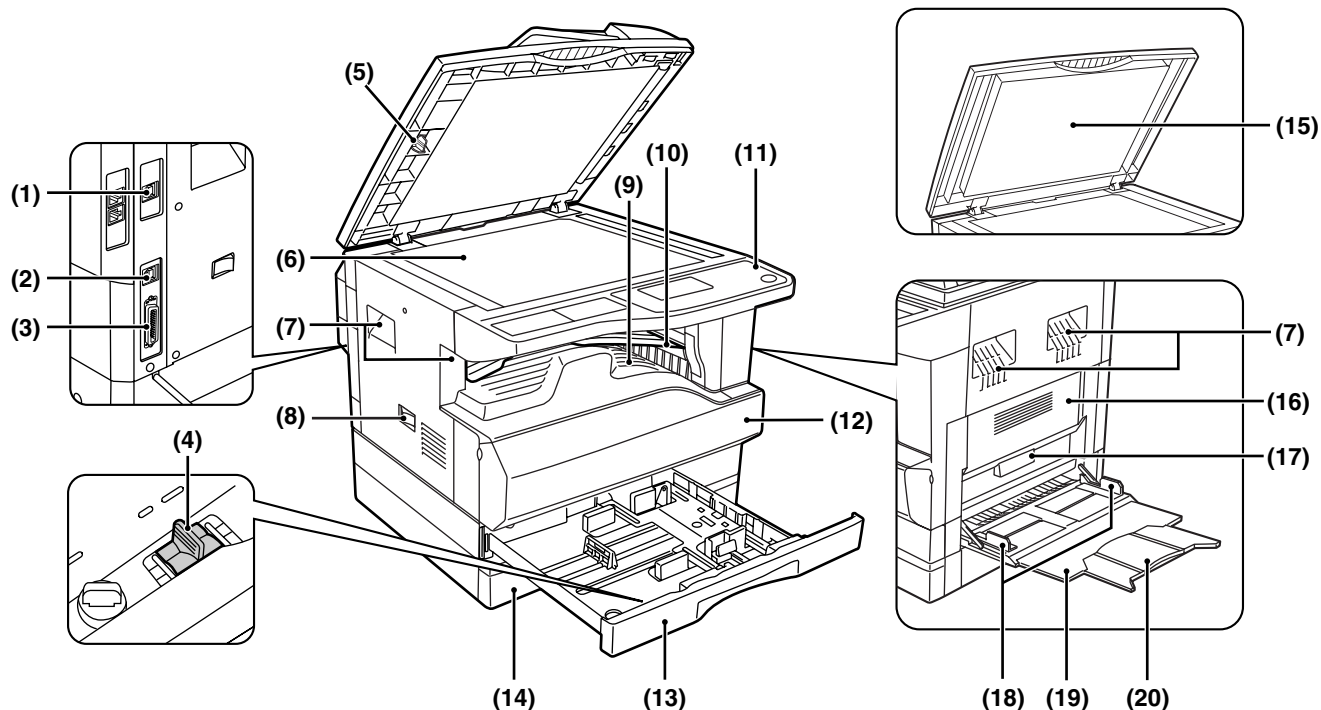

(1) USB 2.0 port (USB-2) (when the dual function board is installed)

Connect to your computer to this port to use the printer and scanner functions.

(2) USB 1.1 port (USB-1)

Connect to your computer to this port to use the printer and scanner functions.

(3) Parallel port

Connect to your computer to this port to use the printer function.

(4) Charger cleaner

Use to clean the transfer charger.

(5) Glass cleaner

Use to clean the original scanning glass.

(6) Document glass

Place an original that you wish to scan face down here. (Page 45)

(7) Handles

Use to move the machine.

(8) Power switch

Press to turn the machine power on and off.

(9) Centre tray

Copies and printed pages are output to this tray.

(10) Top tray (when the job separator tray kit is installed)

Received faxes (when the fax option is installed) and print jobs are delivered to this tray.

(11) Operation panel

Contains operation keys and indicator lights.

(12) Front cover

Open to remove paper misfeeds or replace the toner cartridge.

(13) Tray 1

Tray 1 can hold approximately 250 sheets of copy paper (80 g/m² (20 lbs.)).

For restrictions on paper types and weights, see "PAPER" (page 18).

(14) Tray 2

Tray 2 can hold approximately 250 sheets of copy paper (80 g/m² (20 lbs.)).

For restrictions on paper types and weights, see "PAPER" (page 18).

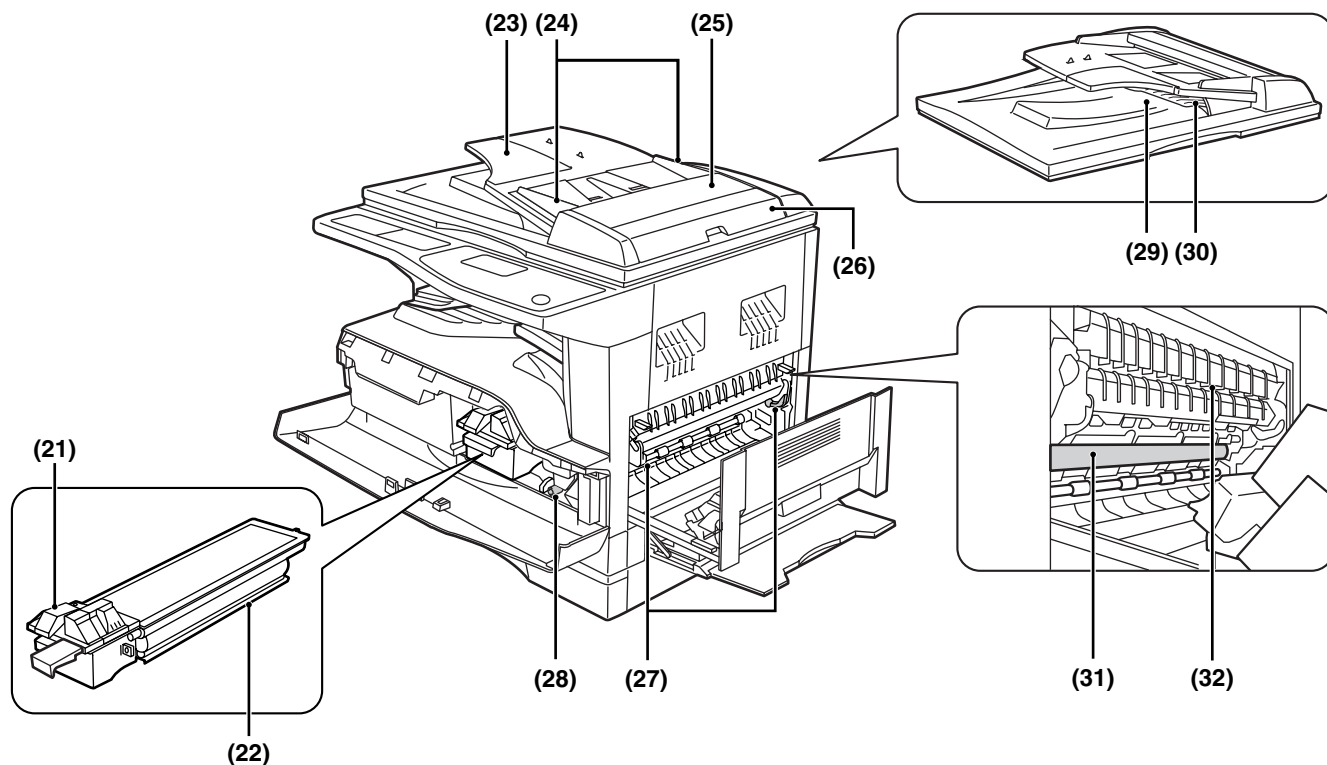

- (15) Document cover (when installed)**
Open to make a copy from the document glass.
- (16) Side cover**
Open to remove misfed paper.
- (17) Side cover handle**
Pull to open the side cover.
- (18) Bypass tray guides**
Adjust to the width of the paper when using the bypass tray.
- (19) Bypass tray**
Special paper (heavy paper or transparency film) can be fed from the bypass tray.
- (20) Bypass tray extension**
Pull out when feeding large paper such as A3 and B4 (11" x 17" and 8-1/2" x 14").
- (21) Toner cartridge lock release lever**
To replace the toner cartridge, pull out the toner cartridge while pushing on this lever.
- (22) Toner cartridge**
Contains toner.
- (23) Document feeder tray (when the SPF is installed)**
Place the original(s) that you wish to scan face up here. Up to 40 sheets can be placed.
- (24) Original guides (when the SPF is installed)**
Adjust to the size of the originals.
- (25) Feeding roller cover (when the SPF is installed)**
Open to remove misfed originals.

- (26) Right side cover (when the SPF is installed)**
Open to remove misfed originals.
- (27) Fusing unit release levers**
To remove the paper misfed in the fusing unit, push down on these levers and remove the paper.



The fusing unit is hot. Do not touch the fusing unit when removing misfed paper. Doing so may cause a burn or injury.

- (28) Roller rotating knob**
Rotate to remove misfed paper.
- (29) Exit area (when the SPF is installed)**
Originals exit the machine here after copying/scanning when the SPF is used.
- (30) Reversing tray (when the RSPF is installed)**
Pull out to remove misfed originals.
- (31) Photoconductive drum**
Images are formed on the photoconductive drum.



Do not touch the photoconductive drum (green portion) when removing the misfed paper. Doing so may damage the drum and cause smudges on copies.

- (32) Fusing unit paper guide**
Open to remove misfed paper.



The model name is on the front cover of the machine.

OPERATION PANEL

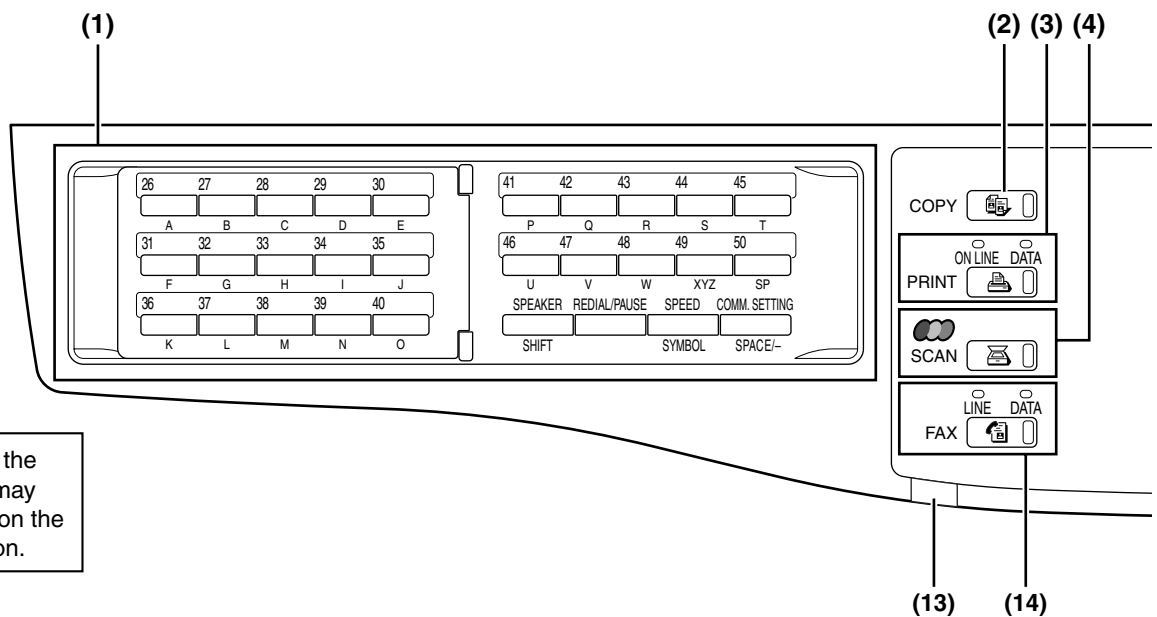

The indicators of the operation panel may differ depending on the country and region.

(1) Keys for fax function (when the fax option is installed)

These are used in fax mode. For more information, see the "Operation manual (for facsimile)" that accompanies the optional facsimile expansion kit.

(2) [COPY] key / indicator

Press to select copy mode. If pressed when "Ready to copy." appears or during warm-up, the total number of sheets used (page 36) appears while the key is pressed.

(3) [PRINT] key / indicator

Press to select print mode.

• **ONLINE indicator**

Print jobs can be received when this indicator is lit.

• **DATA indicator**

This lights steadily when there is a print job in memory that has not been printed, and blinks during printing.

(4) [SCAN] key / indicator

Press to select scan mode. (To connect a computer to the USB port on the machine and use the scanner function, see the "Operation manual (for printer and scanner)". To use the machine as a network scanner, see the "Operation manual (for network scanner)" that accompanies the optional network expansion kit.)

(5) Display

Shows various messages. For more information see page 16.

(6) [BACK] key

Press to return the display to the previous screen.

(7) [FAX STATUS] key (when the fax option is installed)

This key is used in fax mode. For more information, see the "Operation manual (for facsimile)" that accompanies the optional facsimile expansion kit.

(8) [OK] key

Press to enter the selected setting.

(9) Copy number display

The selected number of copies appears. During copying, this shows the remaining number of copies.

(10) Numeric keys

Use to select the number of copies.

(11) [INTERRUPT] key (☹) / INTERRUPT indicator

Interrupts a copy run to allow an interrupt copy job to be performed. (Page 63)

(12) [C] key

Press to clear the set number of copies or stop a copy run.

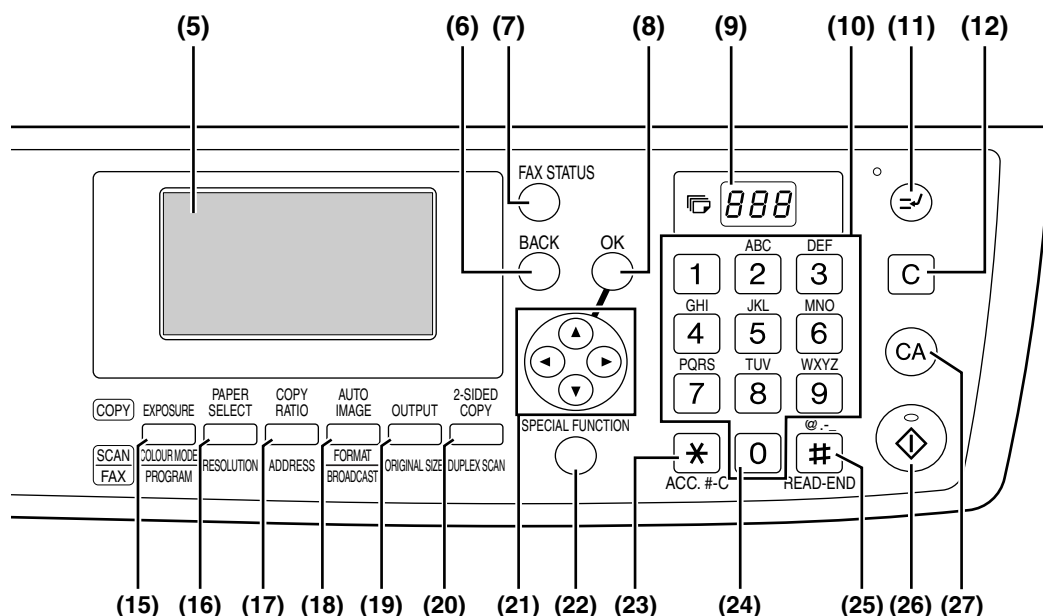

(13) LINE STATUS indicator (when the fax option is installed)

This key is used in fax mode. For more information, see the "Operation manual (for facsimile)" that accompanies the optional facsimile expansion kit.

(14) [FAX] key / indicator (when the fax option is installed)

LINE indicator, DATA indicator

This key is used in fax mode. For more information, see the "Operation manual (for facsimile)" that accompanies the optional facsimile expansion kit.

(15) [EXPOSURE] key

Use to select the exposure mode. "AUTO", "TEXT", or "PHOTO" can be selected. (Page 48)

(16) [PAPER SELECT] key

Use to manually select a paper tray. (Page 49)

(17) [COPY RATIO] key

Press to select a reduction or enlargement copy ratio. (Page 52)

(18) [AUTO IMAGE] key

Press to have the copy ratio selected automatically. (Page 52)

(19) [OUTPUT] key (Only effective when the dual function board is installed)

Use to select the sort function. (Page 64)

(20) [2-SIDED COPY] key (only on models that support two-sided printing)

Select the two-sided copying mode. (Page 56)

(21) Arrow keys

Press to move the highlighting (which indicates that an item is selected) in the display.

(22) [SPECIAL FUNCTION] key

Press to select special functions.

(23) [ACC.#-C] key (*)

Press the end the use of an account and return the display to the account number entry screen. (Page 23)

(24) [0] key

Press during a continuous copy run to display the number of copies completed.

(25) [READ-END] key (#)

When copying in sort mode from the document glass, press this key when you have finished scanning the original pages and are ready to start copying. (Page 64)

(26) [START] key (Ⓢ) / indicator

Copying is possible when this indicator is on. Press the key to start copying.

(27) [CA] key

Clears all selected settings and returns the machine to the default settings. (Page 18)

Display (base screen)

Example: Copy mode

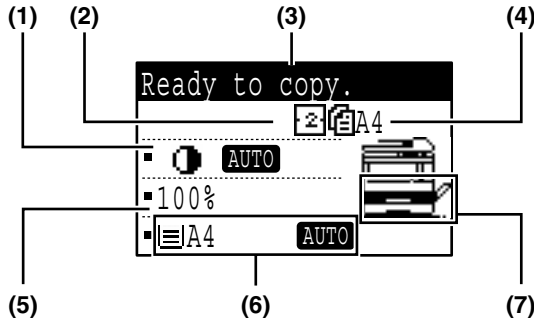

* The display shown is the AR-M206/AR-M207 (when the optional RSPF is installed) display.

Icons appearing in the special function icon display

	1-sided to 2-sided copy		Centre erase copy*
	2-sided to 2-sided copy		Edge + Centre erase*
	2-sided to 1-sided copy		2 in 1 copy*
	Sort function*		4 in 1 copy*
	Margin shift copy*		Dual page copy
	Edge erase copy*		Card shot*

* These only appear when the dual function board is installed.

- (1) **Exposure display**
Indicates the selected exposure mode.
- (2) **Special function icon display**
Icons of enabled special functions will appear.
- (3) **Message display**
Messages are displayed regarding machine status and operation.
- (4) **Original size display**
The size of the placed original and the icon of the original scanning mode will appear.
 - : One-sided scanning in the SPF.
 - : Scanning on the document glass
 - : Two-sided scanning in the RSPF.
- (5) **Copy ratio display**
Displays the copy ratio for reduction or enlargement.
- (6) **Paper size display**
Displays the selected paper size. When "AUTO" appears, the most suitable size of paper is automatically selected.
- (7) **Paper tray display**
The selected paper tray is highlighted.

OPERATION IN COPY, PRINT, SCAN, AND FAX MODES

Some operations in the various modes of the machine cannot take place simultaneously.

Interrupting operation \ Interrupted operation		Interrupting operation				
		Copy output	Printing	Scanning	Faxing Scanning originals	Printing faxes
Copying	Output	Yes*1	No	No	No	No
	Output	Yes*2	No	Yes*4	Yes*5	No
Scanning	Scanning an original	No	No	No	No	No
Faxing	Scanning an original	No	Yes*3	No	No	Yes
	Output	Yes*2	No	Yes*2	Yes	No

*1 Can be used after pressing the [INTERRUPT] key (⊖).

*2 After the page that is currently being printed is output, the job is interrupted.

*3 Only possible when the computer is connected to the USB-2 port.

*4 Only possible when the computer is connected to the parallel port or USB-1 port; the job is interrupted after the page that is currently being printed is output.

*5 After output of the page that is currently being printed via the parallel port or USB-1 port, the job is interrupted.



- Printing is not possible when the front or side cover is opened for machine maintenance, or when a misfeed occurs or the machine runs out of paper or toner, or when the drum cartridge reaches its replacement time.
- If an original misfeed occurs in the SPF, printing will not be possible until the misfed original is removed and the SPF is ready for use.

TURNING THE POWER ON AND OFF

The power switch is located on the left side of the machine.

POWER ON

Turn the power switch to the "ON" position

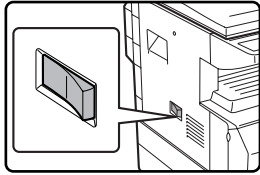

- It will take about 45 seconds for the machine to warm up.
- When the power switch is turned to the "ON" position, the message "System check." will appear in the message display and warm-up will start.

Once the copier has finished warming up, the message display will change to "Ready to copy." and the START indicator will light up to indicate that copying is possible. Copy settings can be selected during warm-up.

- If auditing mode has been enabled (page 79), the message "Enter your account number." will appear after warming up. Once a valid account number has been entered, the message display will change to "Ready to copy." and copying will be possible.

POWER OFF

Make sure that the machine is not in operation and then turn the power switch to the "OFF" position.

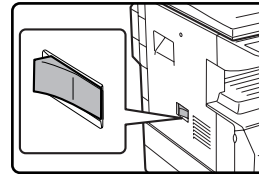

If the power switch is turned off while the machine is in operation, a misfeed may occur and the job that was in progress will be cancelled.

1



- If the fax option is installed, be sure to keep the power turned on. Faxes cannot be received when the power is turned off.
- The machine is set at the factory to return all settings to the default settings one minute after a copy job is finished (auto clear function). When the settings return to the default settings, any functions that were selected are cancelled. The auto clear time can be changed in the key operator programs. (Page 83)

Power save modes

The machine has two power save modes to reduce power consumption, thereby helping to reduce environmental pollution and conserve resources.

Preheat mode

This function automatically switches the machine to a low power consumption state if the duration of time set in the key operator programs elapses without the machine being used when the power is on. In preheat mode the display turns off. Normal operation automatically resumes when a key on the operation panel is pressed, an original is placed, or a print job or fax is received.

Auto power shut-off mode

This function automatically switches the machine to a state that consumes even less power than preheat mode if the duration of time set in the key operator programs elapses without the machine being used when the power is on. During auto power shut-off, only the mode key indicators are lit. To restore the machine to normal operation, press any one of the mode keys. Normal operation also resumes automatically when a print job or fax is received or scanning is begun from a computer. While auto power shut-off is in effect, pressing a key other than a mode key will have no effect.



The preheat mode activation time and the "Auto power shut-off timer" can be changed in the key operator programs. (Page 85)

Default settings

The machine is set at the factory to return all settings to the default settings one minute after a copy job is finished (auto clear function) or when the [CA] key is pressed. When the settings return to the default settings, any functions that were selected are cancelled.

The auto clear time can be changed in the key operator programs. (Page 83)

In the default state the display shown below appears. The default state of the display may vary depending on settings in the key operator programs.

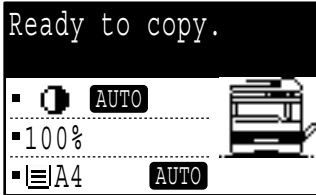

* The screen is that of the AR-M206/AR-M207 (when the RSPF is installed).

LOADING PAPER

The message "TRAY<*>:Add paper." will be displayed when there is no copy paper in the selected paper tray. (<*> is the tray number.) Load paper in the indicated paper tray.

PAPER

The specifications for the types and sizes of paper that can be loaded in the paper trays are shown below.

Paper tray	Tray No.*4	Paper type	Paper size	Weight	Capacity
Tray 1	1	Standard paper Recycled paper	A5*1, B5, B5R, A4, A4R, B4, A3 (5-1/2" x 8-1/2"*1 (Invoice), 8-1/2" x 11" (Letter), 8-1/2" x 11"R, 8-1/2" x 13" (Foolscap), 8-1/2" x 14" (Legal), 11" x 17" (Ledger))	56 g/m ² to 90 g/m ² *2 (15 lbs. to 24 lbs.)*2	250 sheets (80 g/m ² (20 lbs.))*3 (Load paper lower than the line on the tray)
Tray 2	2				
Tray of 250-sheet paper feed unit	2 or 3				
Tray of 2 x 250-sheet paper feed unit	2 or 3 3 or 4				
Bypass tray		Standard paper Recycled paper	A6R to A3 (5-1/2" x 8-1/2" (Invoice) to 11" x 17" (Ledger))	56 g/m ² to 80 g/m ² (15 lbs. to 20 lbs.)	100 sheets*3
		Thick paper		Max. 200 g/m ² (54 lbs.)	Load one sheet of these papers at a time to the bypass tray.
		Transparency film Labels			
		Envelopes	International DL (110 mm x 220 mm), International C5 (162 mm x 229 mm) Commercial 9 (3-7/8" x 8-7/8"), Commercial 10 (4-1/8" x 9-1/2")		5 sheets

*1 A5 (5-1/2" x 8-1/2") can be used in tray 1 but cannot be used in other trays (including trays in optional paper feeding unit).

*2 When making a large number of copies or prints using 90 g/m² (24 lbs.) paper, remove the output from the paper output tray when about 100 pages have been printed. The output may not stack correctly if more than 100 pages are allowed to accumulate.

*3 The number of sheets of the paper which can be set changes with the weight of a paper. (The indicated numbers are for 80 g/m² (20 lbs.) paper.)

*4 The trays are numbered 1, 2, 3, and 4 from the top.

Paper that can be used for automatic 2-sided printing

Paper used for automatic two-sided printing must meet the following conditions:

Paper type: Plain paper (special paper cannot be used.)

Paper size: Standard sizes (A3, B4, A4, A4R, B5, B5R, A5, 11" x 17", 8-1/2" x 14", 8-1/2" x 13", 8-1/2" x 11", 8-1/2" x 11"R)

Paper weight: 56 g/m² to 90 g/m² (15 lbs. to 24 lbs.)

Special paper

Follow these guidelines when using special paper.

- Use SHARP recommended transparency film and label sheets. Using other than SHARP recommended paper may result in misfeeds or smudges on the output.
- There are many varieties of special paper available on the market, and some cannot be used with this machine. Before using special paper, contact your authorised service representative.
- Before using other than SHARP recommended paper, make a test copy to see if the paper is suitable.

LOADING PAPER

Make sure that the machine is not copying or printing, and then follow these steps to load paper.

Loading paper in a tray

1 Gently lift and pull out the paper tray.

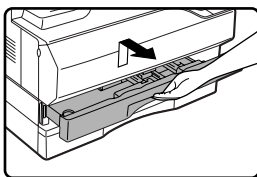

If you are adding the same size of paper, go to step 3. If you are loading a different size of paper, go to the next step.

2 Adjust the plates in the tray to the length and width of the paper.

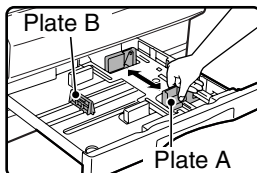

- The plate A is a slide-type guide. Grasp the locking knob on the guide and slide the guide to the indicator line of the paper to be loaded.
- The plate B is an insert-type guide. Remove it and then insert it at the indicator line of the paper to be loaded.
- When using 11" x 17" sized paper store the plate B in the slot at the left front of the paper tray.

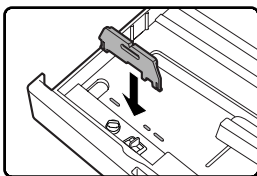

3 Push the pressure plate down.

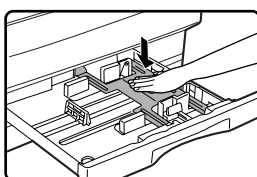

Push the centre of the pressure plate down until it locks into place.

4 Fan the paper.

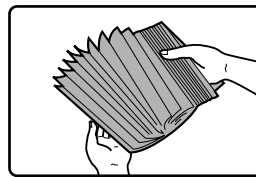

Fan the paper well before loading it. If the paper is not fanned, double-feeds or misfeeds may occur.

5 Place the paper in the tray.

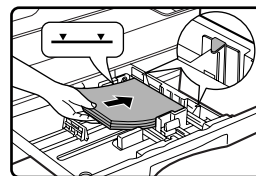

- Do not load paper higher than the line on the tray (up to 250 sheets).
- Make sure that the paper fits under the tab on the right side of the tray.
- Make sure the stack of paper is straight before loading it. When adding paper, take the remaining paper out and combine it into a single stack with the new paper.

6 Push the paper tray back in.

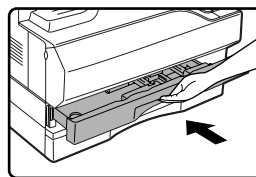

Push the upper paper tray in completely.



If the size of the loaded paper is different from the size shown in the display, be sure to follow the procedure in "CHANGING THE PAPER SIZE SETTING OF A TRAY" (page 21) to change the paper size setting of the tray.

Loading paper in the bypass tray

1 Open the bypass tray.

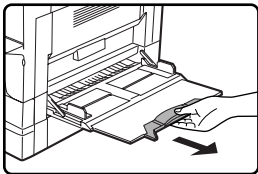
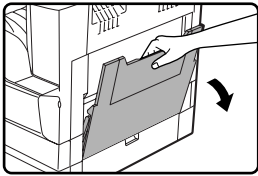

Pull out the bypass tray extension to load B4 and A3 (8-1/2" x 14" and 11" x 17") size paper.

2 Set the bypass tray guides to the paper width.

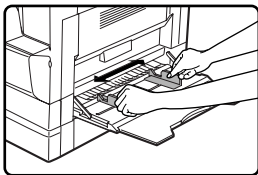

3 Insert the copy paper (print side down) all the way into the bypass tray.

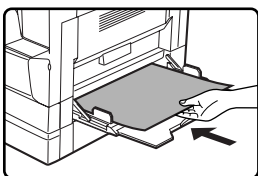

Make sure that the print side of the paper is face down. To prevent a misfeed, verify once more that the bypass tray guides are adjusted to the width of the paper.



If you loaded paper in the bypass tray, press the [PAPER SELECT] key to select the bypass tray.

Important points when inserting paper in the bypass tray

- Up to 100 sheets of standard copy paper can be set in the bypass tray.
- Be sure to place A6 and B6 (5-1/2" x 8-1/2") size paper and envelopes horizontally as shown in the following diagram.

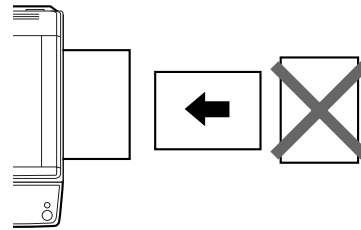

- When loading envelopes, make sure that they are straight and flat and do not have loosely glued construction flaps (not the closure flap).
- Special papers except SHARP recommended transparency film, labels, and envelopes must be fed one sheet at a time through the bypass tray.
- When adding paper, first remove any paper remaining in the tray, combine it with the paper to be added and then reload as a single stack. The paper to be added must be the same size and type as the paper already in the tray.
- Do not use paper that is smaller than the original. This may cause smudges or unclean images.
- Do not use paper that has already been printed on by a laser printer or plain paper fax machine. This may cause smudges or unclean images.

Envelopes

Do not use the following envelopes, as misfeeds will occur.

- Envelopes with metal tabs, clasps, strings, holes, or windows.
- Envelopes with rough fibers, carbon paper, or glossy surfaces.
- Envelopes with two or more flaps.
- Envelopes with tape, film, or paper attached to the flap.
- Envelopes with a fold in the flap.
- Envelopes with glue on the flap to be moistened for sealing.
- Envelopes with labels or stamps.
- Envelopes that are slightly inflated with air.
- Envelopes with glue protruding from the seal area.
- Envelopes with part of the seal area peeled off.

CHANGING THE PAPER SIZE SETTING OF A TRAY

If the size of the loaded paper is different from the size shown in the display, follow the steps below to change the paper size setting of the tray.

The paper size setting cannot be changed during copying, printing, fax printing (when the fax option is installed), or interrupt copying, or when a misfeed has occurred. However, if the machine is out of paper or out of toner, the paper size setting can be changed during copying, printing, and fax printing.

See "PAPER" (page 18) for information on the specifications for the types and sizes of paper that can be loaded in the paper trays.

The paper size cannot be set for the bypass tray.

1 Press the [SPECIAL FUNCTION] key.

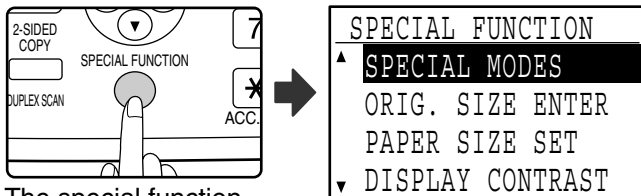

The special function screen will appear.

The screen shown above is the copy mode screen.

2 Press the [▼] or [▲] key to select "PAPER SIZE SET".

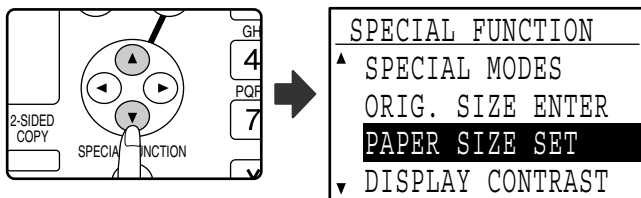

3 Press the [OK] key.

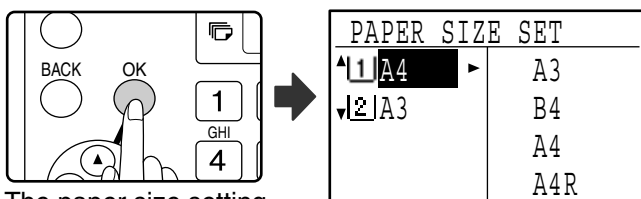

The paper size setting screen will appear.



[1]: Shows tray "1".

[2]: Shows tray "2".

For the paper trays and tray numbers, see "PAPER" on page 18.

4 Press the [▼] or [▲] key to select the paper tray for which the paper size is being changed.

Example: Tray 2

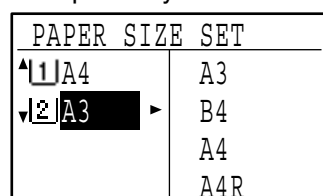
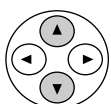

5 Press the [▶] key.

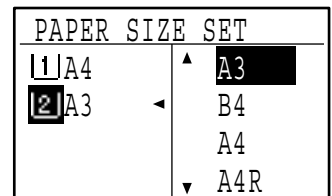
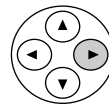

The cursor moves to the paper size selection position on the right.

6 Press the [▼] or [▲] key to select the paper size.

Example: Selecting B4 size

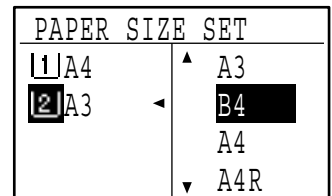
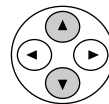

To change the size of another paper tray, press the [◀] key and then repeat steps 4 to 6.

7 Press the [OK] key.



A message asking you to confirm the new paper size setting will appear.

8 Press the [OK] key.



The selected paper size will be stored and the display will return to the base screen.



Affix the paper size label for the paper size selected in step 6 to the label position on the right end of the tray.

DISABLING (ENABLING) AUTO TRAY SWITCHING

When auto tray switching is enabled and paper runs out during copying or printing, the job will continue using paper from a different tray if that tray has the same size of paper in the same orientation. (This function does not operate when using the bypass tray or when a fax is being printed.) This function has been enabled at the factory. If you prefer to disable the function, follow the steps below.

1 Press the [SPECIAL FUNCTION] key.

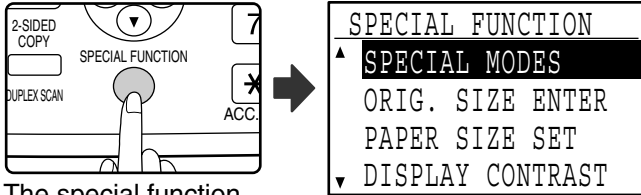

The special function screen will appear.

The above screen appears in copy mode.

2 Select "PAPER SIZE SET" with the [▼] or [▲] key.

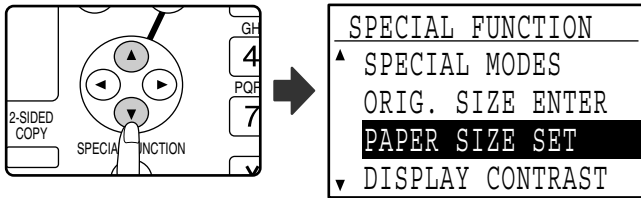

3 Press the [OK] key.

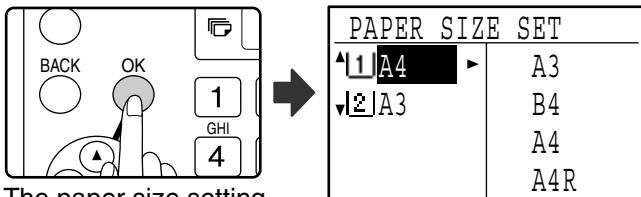

The paper size setting screen will appear.

4 Press the [▼] key repeatedly until "AUTO TRAY SWITCHING" appears.

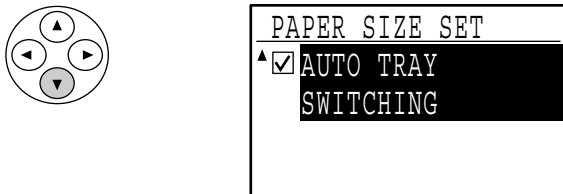

Move the cursor to the lowest tray and then press the [▼] key again. The above screen will appear.

5 Press the [OK] key.

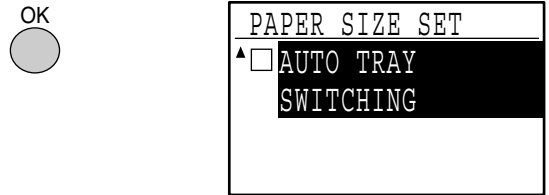

When a checkmark does not appear in the checkbox, the auto tray switching function will not operate.

6 Press the [▲] key.

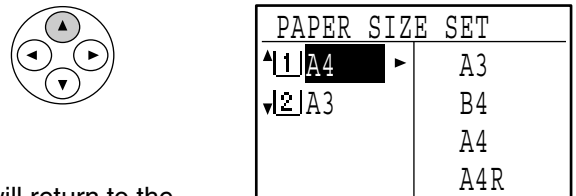

You will return to the paper size setting screen.

To re-enable auto tray switching, press the [OK] key in the screen of step 5 so that a checkmark appears.

AUDITING MODE

When auditing mode is enabled, a count is kept of the pages printed by each account. The page counts can be viewed in the display.

This function is enabled in the key operator programs. (For the counts in copy, print, and scan modes, see page 79. For the counts in fax mode, see the "Operation manual (for facsimile)" that accompanies the optional facsimile expansion kit.)

NUMBER OF ACCOUNTS IN AUDITING MODE

	Mode	Number of accounts	Remarks
(1)	Same for copy, print, and scan modes	50 maximum	Copying, printing, and scanning counts are managed under one account number.
(2)	Fax	50 maximum	Fax counts are managed under one account number.

1



The same account number can be assigned to (1) and (2).

USING AUDITING MODE

When auditing mode is turned on, the account number entry screen is displayed. Enter your account number (five-digit identification number) as explained below before performing a copy, fax, or scan operation.

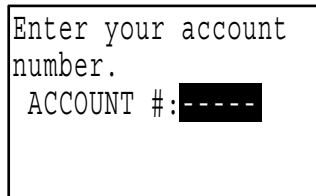

1 Enter your account number (five digits) with the numeric keys.

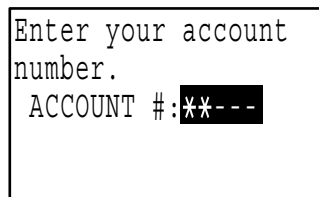
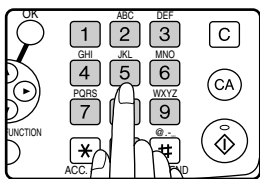

- As the account number is entered, the hyphens (-) change to asterisks (*). If you enter an incorrect digit, press [C] key and re-enter the correct digit.
- When a valid account number is entered, the current count of the account will appear in the message display of the base screen. After 6 seconds (factory default setting), the base screen appears. (Page 18)

* In copy mode and print mode, the number of sheets remaining until the limit is reached is also shown if "ACCOUNT LIMIT" (page 81) is enabled in the key operator programs.

Example: Copy mode

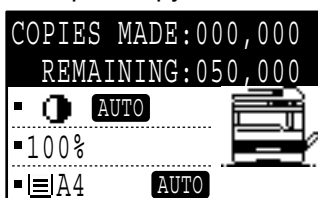

- If you enter a account number for copy mode that has also been programmed for fax mode, you can change to fax mode after completing the copy operation and continue with the fax operation without re-entering your account number. If you enter an account number for copy mode that has not been programmed for fax mode, enter your account number for fax mode after you press the [FAX] key to change to fax mode.
- If an invalid account number is entered in step 1, the account number entry screen reappears.
- When "ACC. # SECURITY" (page 81) in the key operator programs is enabled, a warning message will appear and operation will not be permitted for 1 minute if an invalid account number is entered 3 times in a row.

2 When the copy job is finished, press the [ACC.#-C] key (*).

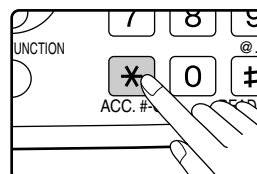

If you are performing an interrupt copy job (page 63) when auditing mode is enabled, be sure to press the [INTERRUPT] key (⊖), [CA] key, or [ACC.#-C] key (*) when finished to exit interrupt mode.

2

TROUBLESHOOTING AND MAINTENANCE

This chapter explains general troubleshooting and maintenance procedures such as removing misfeeds, replacing the toner cartridge, and cleaning the machine, as well as troubleshooting for the copy function. For troubleshooting for the fax function, printer function, and scanner function, see the respective manuals for each function.

TROUBLESHOOTING

MACHINE/COPYING PROBLEMS

The machine does not operate.	25
Power is on but copying is not possible.	25
Copies are too dark or too light.	25
Text is not clear in a copy.	25
Blank copies.	25
The paper size used for the copy is different from the selected paper size (part of the image is cut off or too much of the page is blank).	26
Wrinkles appear in the paper or the image disappears in places.	26
Paper misfeed.	26
The original size is not automatically selected or the copy is not made on paper that matches the size of the original.	27
Copies are smudged or dirty.	27
White or black lines appear on copies.	27
A tray's paper size setting cannot be set.	27
A copy job stops before it is finished.	27
Scanning of the original stops before it is completed.	27
A light in the room flickers.	27

INDICATORS AND DISPLAY MESSAGES28

REMOVING MISFEEDS29

REPLACING THE TONER CARTRIDGE.....35

CHECKING THE TOTAL OUTPUT COUNT36

CLEANING THE MACHINE37

ADJUSTING THE DISPLAY CONTRAST39

TROUBLESHOOTING

MACHINE/COPYING PROBLEMS

Check the following troubleshooting list before requesting service as many problems can be fixed by the user. If you are unable to solve the problem by checking the list, turn off the power switch, unplug the power cord.

Problems related to general use of the machine and copying are described below.

If a problem occurs in printer or scanner mode, see the "Operation manual (for printer and scanner)". If a problem occurs in fax mode, see the "Operation manual (for facsimile)" that accompanies the optional facsimile expansion kit.

If the message "Call for service. **-*" appears in the display, turn off the power switch, wait about 10 seconds, and then turn the power switch back on. If the message still appears after switching the power on and off several times, a failure may have occurred. In this case, promptly unplug the power cord and contact your authorised service representative.

Note: Letters and numbers appear in **-* above. When you contact your Sharp dealer, please tell your dealer what numbers appear.

The following problems are related to the general operation of the machine and copying.









Problem	Cause and solution	Page
The machine does not operate.	The power cord is not plugged into a power outlet. → Plug the power cord into a grounded outlet.	–
	The power switch is turned off. → Turn the power switch on.	17
	The machine is warming up. → The machine requires about 45 seconds to warm up after the power switch is turned on. While the machine is warming up, copy settings can be selected but copying is not possible. Wait until "Ready to copy." appears.	17
	The front cover or the side cover is not completely closed. → Close the front cover or the side cover.	–
	The machine is in auto power shut-off mode. → When auto power shut-off mode has activated, only mode key indicators are lit; all other indicators and the display are off. The machine returns to normal operation when any of the mode keys are pressed, a print job is received, a fax is received, or when scanning from a computer is started. * Except when print hold for the fax function is enabled.	17
Power is on but copying is not possible.	The COPY indicator is off. → Press the [COPY] key to set the machine to copy mode.	14
Copies are too dark or too light.	An appropriate exposure for the original has not been selected. → Select a suitable exposure mode with the [EXPOSURE] key. If "TEXT" or "PHOTO" is selected, set an appropriate exposure level with the [◀] or [▶] key. → If the copy is too light or too dark even though "AUTO" was selected with the [EXPOSURE] key, adjust the automatic exposure level. The automatic exposure level is adjusted in "EXPOSURE ADJUST" (page 86) in the key operator programs.	48
Text is not clear in a copy.	The correct original type has not been selected in the copy exposure setting screen. → Change the exposure setting to "TEXT" with the [EXPOSURE] key.	48
Blank copies	The original is not placed face up in the SPF or face down on the document glass. → Place the original face up in the SPF or face down on the document glass.	45

Problem	Cause and solution	Page
<p>The paper size used for the copy is different from the selected paper size (part of the image is cut off or too much of the page is blank).</p>	<p>The original was placed in the wrong position. → Place the original correctly.</p>	45
	<p>An appropriate ratio was not used for the size of the original and the size of the paper. → Press the [AUTO IMAGE] key to select the appropriate copy ratio based on the original and copy sizes.</p>	52
	<p>The size of paper loaded in the tray was changed without changing the tray's paper size setting. → The size of the paper loaded in the tray is different from the tray's paper size setting. Set the tray's paper size setting to the same orientation/size as the paper loaded in the tray.</p>	21
<p>Wrinkles appear in the paper or the image disappears in places.</p>	<p>The size or weight of the paper being used is not within the specified range. → Use copy paper within the specified range.</p>	18
	<p>The paper is curled or damp. → Replace it with dry copy paper. During periods when the machine is not used for a long time, remove the paper from the tray and store it in a dark place in a bag to prevent moisture absorption.</p>	–
<p>Paper misfeed.</p>	<p>A paper misfeed has occurred. → See "REMOVING MISFEEDS" to remove the paper misfeed.</p>	29
	<p>The size or weight of the paper being used is not within the specified range. → Use copy paper within the specified range.</p>	18
	<p>The paper is curled or damp. → Replace it with dry copy paper. During periods when the machine is not used for a long time, remove the paper from the tray and store it in a dark place in a bag to prevent moisture absorption.</p>	–
	<p>Paper is not loaded properly. → Make sure the paper is properly loaded.</p>	18
	<p>A piece of paper remains in the machine (after a paper misfeed was removed) → Remove all pieces of misfed paper.</p>	29
	<p>Too much paper is loaded in the tray. → If the stack of paper is higher than the indicator line on the tray, remove some of the paper and reload so that the stack does not exceed the line.</p>	19
	<p>Several sheets of paper stick together. → Fan the paper well before loading it.</p>	19
	<p>The guides on the bypass tray do not match the width of the paper. → Adjust the bypass guides to the size of the loaded paper.</p>	20
	<p>The bypass tray extension is not pulled out. → When loading a large size of paper, pull out the bypass tray extension.</p>	20
	<p>The bypass paper feed roller is dirty. → Clean the roller.</p>	37
<p>A5 (5-1/2" x 8-1/2") paper is loaded in tray 2 or in the 250-sheet or 2 x 250-sheet paper feed unit. → A5 (5-1/2" x 8-1/2") size paper must be loaded in tray 1 or the bypass tray.</p>	18	

Problem	Cause and solution	Page
The original size is not automatically selected or the copy is not made on paper that matches the size of the original.	Was the SPF (or document cover) opened completely when the original was placed on the document glass? → Open the SPF completely and then place the original on the document glass. Close the SPF (or document cover).	45
	The original is curled or folded. → The original size cannot be correctly detected if the original is curled or folded. Straighten the original.	–
	The original has many solid black areas. → If the original includes solid black areas, the original size may not be detected automatically. Press the [SPECIAL FUNCTION] key and select "ORIG. SIZE ENTER" to specify the original size.	–
	The machine is directly exposed to sunlight. → Install in a location that is not exposed to sunlight.	–
	The original is smaller than A5 (5-1/2" x 8-1/2") size. → If the original is smaller than A5 (5-1/2" x 8-1/2"), the size cannot be detected. Follow the procedure in "USING THE BYPASS TRAY TO COPY A SPECIAL SIZE ORIGINAL" to make the copy.	51
	The original is not a standard size. → If the original is a small non-standard size, the size cannot be detected. Manually select a size close to the original size, or follow the procedure in "USING THE BYPASS TRAY TO COPY A SPECIAL SIZE ORIGINAL" to make the copy.	51
Copies are smudged or dirty.	The document glass or the underside of the document cover/SPF is dirty. → Clean these regularly.	37
	The original is smudged or blotchy. → Use a clean original.	–
White or black lines appear on copies.	The scanner glass for the SPF is dirty. → Clean the long, narrow scanning glass.	37
	The transfer charger is dirty. → Clean the transfer charger.	38
A tray's paper size setting cannot be set.	The COPY indicator is off. → Press the [COPY] key to select copy mode.	14
	A copy, print job, or received fax is being printed. → Set the paper size after copying or printing is complete.	16
	The machine has stopped temporarily due to a paper misfeed. → Remove the misfeed and then set the paper size.	29
	An interrupt copy job is in progress. → Set the paper size after the interrupt copy job is finished.	63
A copy job stops before it is finished.	The paper output tray is full. → Copying stops temporarily during a copy each time 250 sheets (150 sheets when a job separator tray kit is installed) are output. Remove the copies from the tray and press the [OK] key to resume copying.	–
	The tray is out of paper. → Load paper.	18
Scanning of the original stops before it is completed.	The display shows "Memory is full." → See "INDICATORS AND DISPLAY MESSAGES".	28
A light in the room flickers.	The same outlet is being used for the light and the machine. → Connect the machine to a dedicated power outlet which is not shared with other electric appliances.	–

INDICATORS AND DISPLAY MESSAGES

If one of the following messages appears in the display, take prompt action as instructed by the message.

Message	Action
 (Maintenance icon)	It is time for regular maintenance. Contact your authorised service representative.
 (Developer replacement required icon)	Developer is required. Contact your authorised service representative as soon as possible.
 Maintenance required. Call for service.	Maintenance required soon. Contact your authorised service representative.
 Call for service. **-**	Turn off the power and then turn it back on. If this does not clear the message, write down the 2-digit main code and 2-digit sub-code ("**-**"), turn off the power, and promptly contact your authorised service representative.
 (Toner cartridge replacement required icon)	The toner cartridge must be replaced soon.
 Check the toner cartridge.	Check to see if the toner cartridge has been installed properly.
Remove paper from the output tray and press [OK].	The number of sheets in the output tray (centre tray or top tray) has reached the limit. Remove the paper.
 Load <*> paper into tray <*>.	The paper size specified for the tray is different from the actual size. (Page 21)
Memory is full.	The memory became full while scanning the originals. Press the [START] key () to copy only the originals that have been scanned, or press the [CA] key to cancel the job.

<*>: Tray number

<*>: Size of paper that should be loaded

REMOVING MISFEEDS

When a misfeed occurs during copying, the message " ⚠ Clear paper path." and the location of the misfeed will appear. Check the location and remove the misfeed.



The paper may tear when you remove a misfeed. In this event, be sure to remove all torn pieces of paper from the machine, taking care not to touch the photoconductive drum (the green part). Any scratches or damage to the surface of the drum will cause dirty copies.

First check the misfeed location.

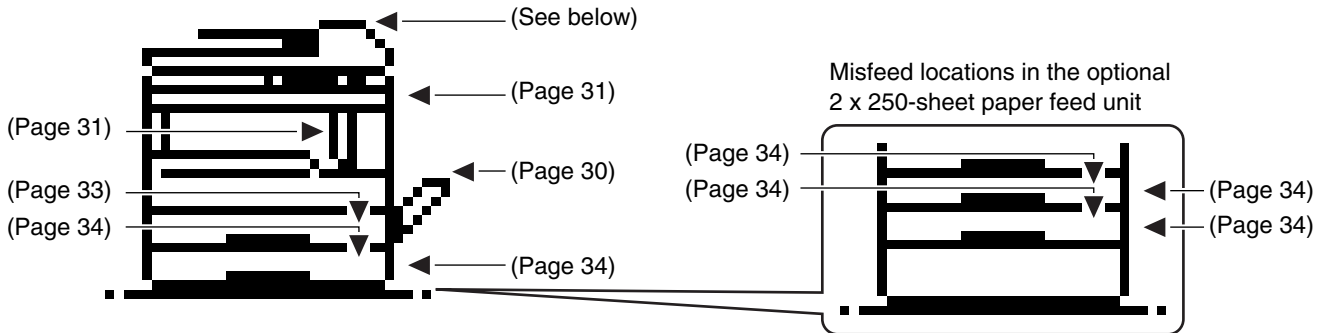

* The illustration shows misfeed locations in the AR-M206/AR-M207 (when the RSPF is installed).

ORIGINAL MISFEED IN THE SPF

If an original misfeeds in the SPF, follow the steps below to remove the misfed original.

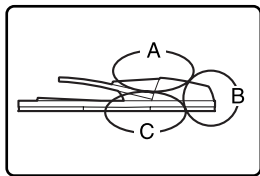

Check locations A, B, and C in the diagram at left to remove the original.

1 Removing original misfeeds from each location.

• Check location A



Open the feeding roller cover and gently remove the misfed original from the document feeder tray. Close the feeding roller cover.

• Check location B

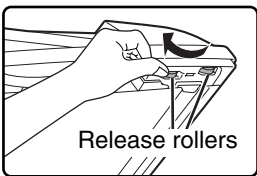

Open the SPF and rotate the two release rollers in the direction of the arrow to feed the original out.

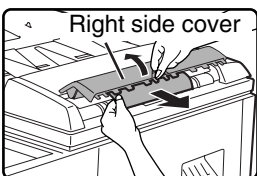

If the misfed original is small (such as an A5 (5-1/2" x 8-1/2") original), or if the misfeed occurred in the reversing tray, open the right side cover and gently remove the original. Close the right side cover.

• Check location C



Carefully remove the misfed original from the exit area.

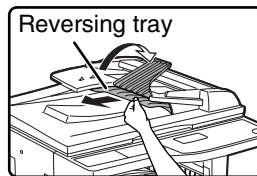

[When using the RSPF:]
If the misfed original cannot be easily removed from the exit area, open the moveable part of the document feeder tray, remove the reversing tray, and then remove the original.



After removing a misfed original from the exit area, be sure to replace the reversing tray and moveable part of the document feeder tray.

2 Open and close the SPF.

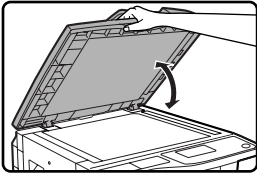

Opening and closing the cover clears the misfeed display. Copying cannot be resumed until this step is performed.

A message may appear indicating the number of originals which must be returned to the document feeder tray. Return the originals to the document feeder tray and press the [START] key (Ⓜ).

MISFEED IN THE BYPASS TRAY

1 Carefully remove the misfed paper from the bypass tray.

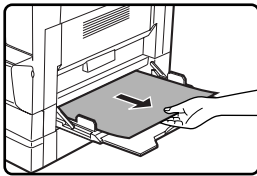

2 Grasp the side cover handle and gently open and close the side cover.

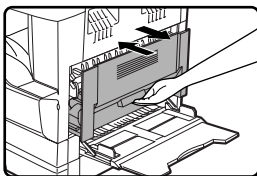

The message " ⚠ Clear paper path." will be cleared and copying will be possible.



Note If the message does not clear, check again to make sure that no pieces of paper remain.

MISFEED IN THE MACHINE

To remove a paper misfeed from the machine, the bypass tray and then the side cover must be opened. Check whether the misfeed occurred in A, B, or C below and then follow the misfeed removal procedure for that location.

1 Open the bypass tray and then the side cover.

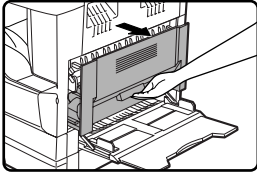

2 Determine where the misfeed occurred.

Location C
If paper is misfed here, go to "Misfeed in C" (page 33).

Location A
If paper is misfed here, go to "Misfeed in A" (below).

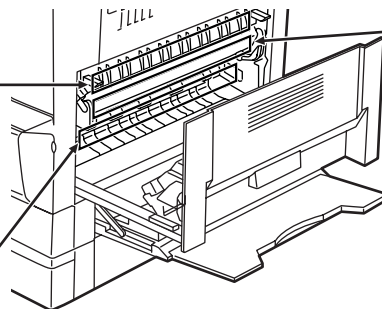

Location B
If paper is misfed here, go to "Misfeed in B" (page 32).

2

Misfeed in A

1 Open the front cover.

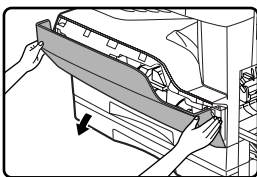

Push gently on both ends of the front cover to open it.

3 Close the front cover and the side cover.

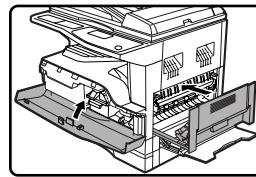

The message " ⚠ Clear paper path." will be cleared and copying will be possible.

2 Turn the roller rotating knob in the direction of the arrow to remove the misfed paper.

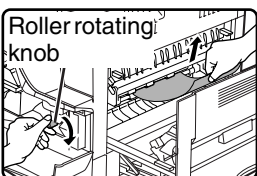

Be careful not to tear the misfed paper during removal.



- When closing the front cover, gently hold both ends.
- When closing the side cover, hold the handle.
- If the message does not clear, check again to make sure that no pieces of paper remain.



Warning The fusing unit is hot. Do not touch the fusing unit when removing misfed paper. Doing so may cause a burn or injury.



Caution Do not touch the photoconductive drum (green portion) when removing the misfed paper. Doing so may damage the drum and cause smudges on copies.

Misfeed in B

1 Open the front cover.

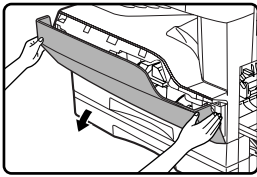

Push gently on both ends of the front cover.

2 Turn the roller rotating knob in the direction of the arrow.

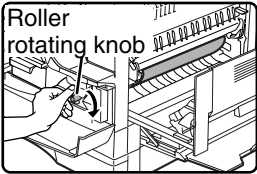

Roller rotating knob

3 Lower the right and left fusing unit release levers and remove the misfed paper.

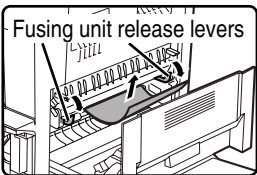

Fusing unit release levers

Be careful not to tear the misfed paper during removal.

4 Lift the fusing unit release levers.

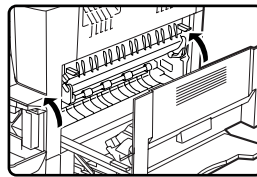

5 Close the front cover and the side cover.

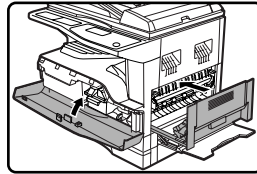

The message " ⚠ Clear paper path." will be cleared and copying will be possible.

Note

- When closing the front cover, gently hold both ends.
- When closing the side cover, hold the handle.
- If the message does not clear, check again to make sure that no pieces of paper remain.

Warning

The fusing unit is hot. Do not touch the fusing unit when removing misfed paper. Doing so may cause a burn or injury.

Caution

- Do not touch the photoconductive drum (green portion) when removing the misfed paper. Doing so may damage the drum and cause smudges on copies.
- Take care not to allow unfixed toner on the misfed paper to soil your hands or clothes.

Misfeed in C

- 1 Lower (1) in the illustration, open the fusing unit paper guide, and remove the misfed paper.**

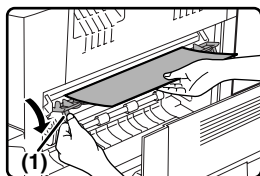

Be careful not to tear the misfed paper during removal.



The fusing unit is hot. Do not touch the fusing unit when removing misfed paper. Doing so may cause a burn or injury.

- 2 If the misfed paper cannot be removed by the previous step, remove it from the paper output area.**

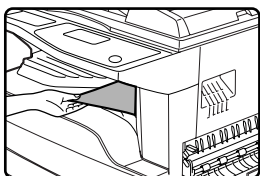

Be careful not to tear the misfed paper during removal.

- 3 Close the side cover.**

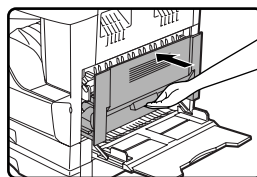

The message " ⚠ Clear paper path." will be cleared and copying will be possible.



- When closing the side cover, hold the handle.
- If the paper was torn, make sure that no torn pieces remain in the machine.
- If the message does not clear, check again to make sure that no pieces of paper remain.

2

MISFEED IN TRAY 1



Make sure that there is no misfed paper in the tray before pulling it out. (Page 31)

- 1 Pull out tray 1 and remove the misfed paper.**

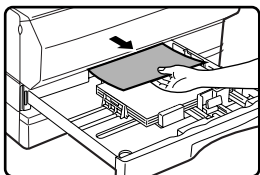

Be careful not to tear the misfed paper during removal.

- 2 Open and close the side cover.**

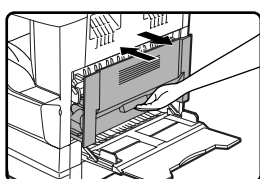

The message " ⚠ Clear paper path." will be cleared and copying will be possible.

- 3 Gently push tray 1 into the machine.**

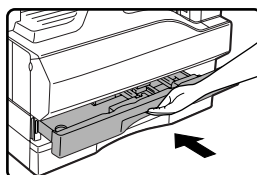

Push the tray in completely.



- When closing the side cover, hold the handle.
- If the message does not clear, check again to make sure that no pieces of paper remain.

MISFEED IN TRAY 2



- Make sure that there is no misfed paper in the tray before pulling it out. (Page 31)
- Also use the following procedure to remove misfeeds that occur in the 250-sheet paper feed unit and the 2 x 250-sheet paper feed unit.

1 Open the side cover.

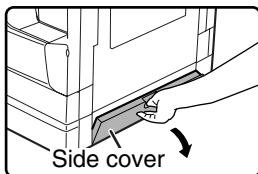

Grasp the handle to open the side cover.

2 Remove the misfed paper.

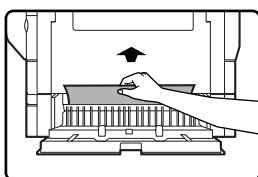

Be careful not to tear the misfed paper during removal.

3 If there was no misfed paper in step 2, pull out tray 2 and remove the misfed paper.

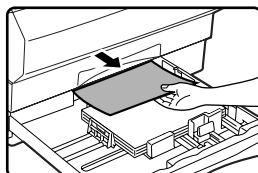

Be careful not to tear the misfed paper during removal.

4 Gently close the side cover.

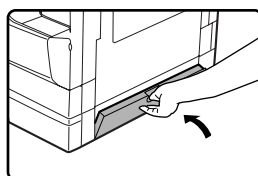

The message " ⚠ Clear paper path." will be cleared and copying will be possible.



If the message does not clear, check again to make sure that no pieces of paper remain.

5 Gently push tray 2 into the machine.

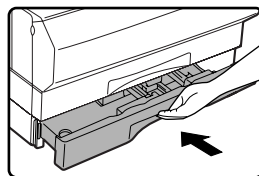

Push the tray in completely.

2 x 250-sheet paper feed unit (AR-D25)

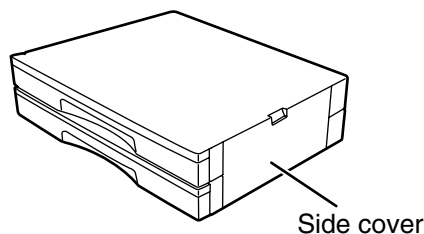

REPLACING THE TONER CARTRIDGE

When the toner replacement icon (⚠) appears, little toner remains. Obtain a replacement cartridge as soon as possible. When the message " ⚠ Add toner. Can not copy or print." appears in the display, the toner cartridge must be replaced before copying can be resumed. Follow the steps below to replace the toner cartridge.



- During a long copy run or when copying originals with many dark areas, the message "Toner replenishment in progress." may appear and copying will stop even though toner remains. The machine will feed toner for about 2 minutes. When the START indicator lights up, press the [START] key (⏪) to resume copying.
- When the toner cartridge replacement required icon (⚠) appears in the display, little toner remains and thus copies may be faint.

1 Open the front cover.

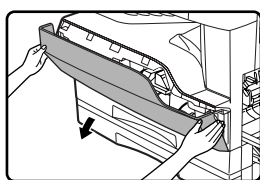

Push gently on both ends of the front cover to open it.

2 Pull the toner cartridge out while pressing on the toner cartridge lock release lever.

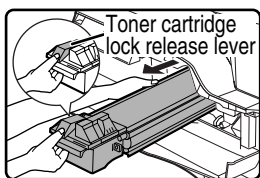

When pulling out the toner cartridge, place one hand on the green part of the cartridge.



- After removing the toner cartridge, do not shake it or tap it. Doing so may cause toner to leak from the cartridge.
- Put the old cartridge immediately in the bag contained in the box of the new cartridge.



- Do not throw the toner cartridge into a fire. Toner may fly and cause burns.
- Store toner cartridges out of the reach of small children.

3 Remove the new toner cartridge from the bag. Grasp the cartridge on both sides and shake it horizontally four or five times. After shaking the cartridge, remove the tape.

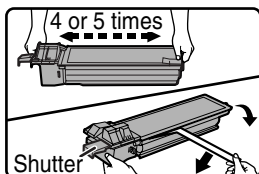

- Do not hold the cartridge by the shutter. It may fall. Grasp the hand grip when holding the cartridge.
- Be sure to shake the cartridge only before the tape is removed.

4 While pressing down on the toner cartridge lock release lever, insert the toner cartridge along the guides all the way in.

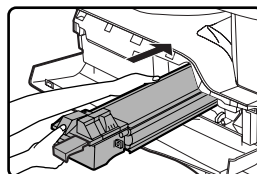

If there is any dirt or dust on the toner cartridge, remove it before installing the cartridge.

5 Remove the tape and then pull the shutter out of the toner cartridge.

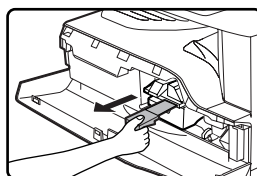

Discard the shutter.

6 Close the front cover.

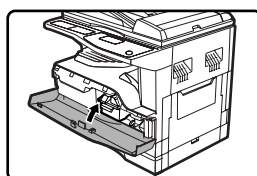

The toner cartridge replacement required icon (⚠) will no longer appear and copying will be possible.



- Even after a new toner cartridge is installed, the toner cartridge replacement required indicator (⚠) may still appear, indicating that copying cannot be resumed (toner is not fed sufficiently). In this case, open and close the front cover. The machine will feed toner again for about two minutes and then copying can be resumed.
- Before closing the front cover, make sure that the toner cartridge is correctly installed.
- When closing the front cover, gently hold both ends.

2

CHECKING THE TOTAL OUTPUT COUNT

To check the total number of pages output in copy, print, and fax modes and the total scan count in scanner mode, hold down the [COPY] key when the machine is in the standby state. The counts will appear while the key is held down. The total output count and the total scan count can be used as a guideline for cleaning. When the total output count and the total scan count exceed "999,999", the counts return to "0".

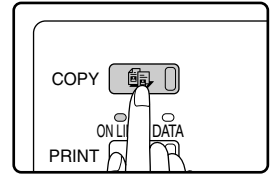

- An A3 or 11" x 17" page is counted as two pages.
- Each two-sided sheet that is output is counted as two pages. (An A3 or 11" x 17" sheet is counted as four pages.)
- Blank copies and blank prints are included in the count.
- If the last page of a two-sided printing job is blank, it is not included in the count.

CLEANING THE MACHINE

CLEANING THE DOCUMENT GLASS AND SPF/DOCUMENT COVER

If the document glass, SPF, underside of the document cover, or the scanner for originals coming from SPF (A) (the long narrow glass surface on the right side of the document glass) become dirty, the dirt may appear on copies. Always keep these parts clean.

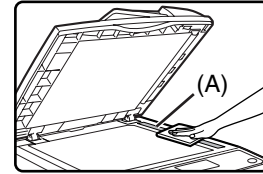
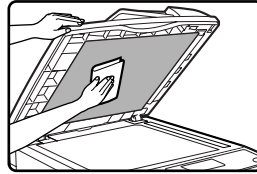
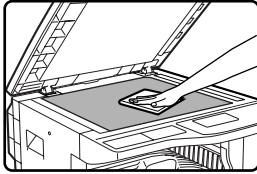

Wipe with a clean, soft cloth. If necessary, moisten the cloth with water or a small amount of neutral detergent. When finished, wipe dry with a clean cloth. Do not use thinner, benzene, or similar volatile cleaning agents.



Do not spray flammable cleaner gas. Gas from the spray may come in contact with the internal electrical components or hot parts of the fusing unit, creating a risk of fire or electrical shock.

2

Cleaning the original scanning glass (only when a SPF is installed)

If white or black lines appear in copies made with using the SPF, use the provided glass cleaner to clean the original scanning glass. (If white or black lines appear in copies, printed pages, or printed fax pages when the SPF is not used, see "CLEANING THE TRANSFER CHARGER" on page 38.)

Example of dirty print image

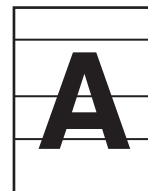

Black lines



White lines

1 Open the SPF and take out the glass cleaner.

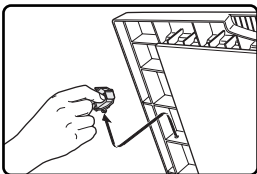

2 Clean the original scanning glass with the glass cleaner.

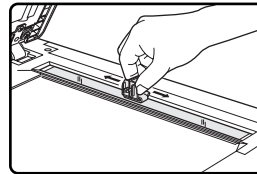

3 Return the glass cleaner to its original position.

CLEANING THE BYPASS TRAY PAPER FEED ROLLER

If misfeeds occur frequently when feeding postcards, envelopes, or heavy paper through the bypass tray, wipe the surface of the paper feed roller with a soft, clean cloth dampened with alcohol or water.

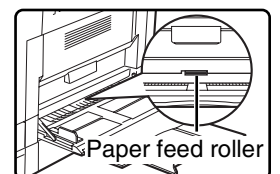

CLEANING THE TRANSFER CHARGER

If white or black lines appear in copies or the image is blotchy, the transfer charger may be dirty. Follow the steps below to clean the charger.

1 Turn the power switch off.

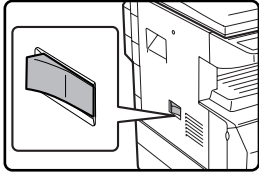

2 Open the bypass tray and the side cover.

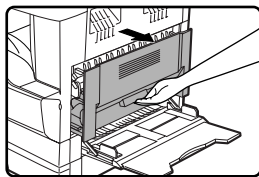

3 While lifting the handle, gently pull out tray 1.

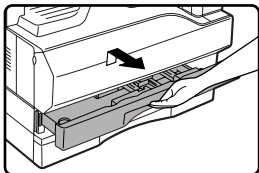

4 Take out the charger cleaner.

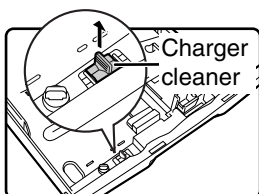

5 Place the charger cleaner on the transfer charger and gently slide the cleaner in the direction indicated by the arrow two or three times.

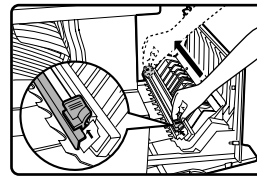

If the sheet metal on the transfer charger is smudged with toner, wipe it with a soft, clean cloth.



Note Slide the charger cleaner from one end to the other end along the groove of the transfer charger. If the cleaner is stopped it reaches the other end or if the direction of movement is reversed, smudges may appear on copies.

6 Return the charger cleaner to its original position.

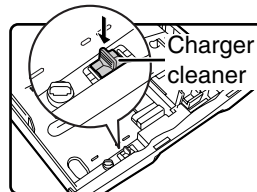

7 Close the tray and side cover.

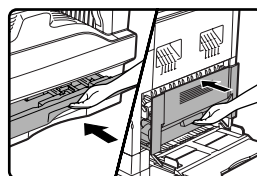

8 Turn the power switch to the "ON" position.

ADJUSTING THE DISPLAY CONTRAST

The contrast of the display can be adjusted as explained below.

1 Press the [SPECIAL FUNCTION] key.

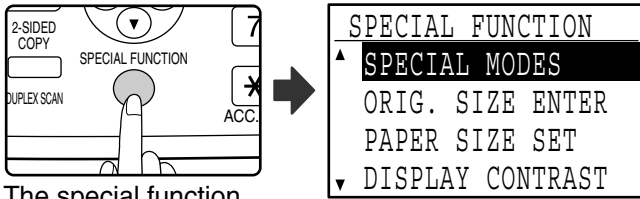

The special function screen will appear.

2 Select "DISPLAY CONTRAST" with the [▼] or [▲] key.

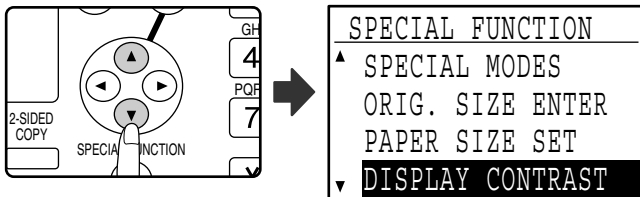

3 Press the [OK] key.

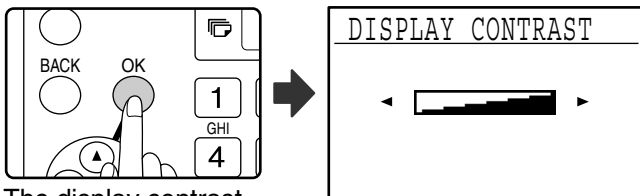

The display contrast adjustment screen will appear.

4 Adjust the contrast with the [◀] or [▶] key.

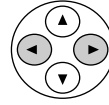

To reset the contrast to the default setting, press the [C] key.

5 Press the [SPECIAL FUNCTION] key.

SPECIAL FUNCTION



You will return to the base screen.

2

3

PERIPHERAL DEVICES AND SUPPLIES

Optional equipment and supplies are explained in this chapter. To purchase optional equipment and supplies, contact your authorised service representative.

OPTIONAL EQUIPMENT

Convenient optional equipment can be installed on the machine as needed.



- As a part of our policy of continuous improvement, SHARP reserves the right to make design and specification changes for product improvement without prior notice.
- Peripheral devices are normally optional, but are incorporated in some models as standard equipment.

	AR-M161	AR-M162	AR-M165	AR-M206	AR-M207
Reversing single pass feeder (AR-RP6N)	No	No	Yes	Yes	Yes
Single pass feeder (AR-SP6N)	Yes	Yes	Yes	Yes	Yes
Document cover (AR-VR5)	Standard	Standard	Standard	Yes	Yes
250-sheet paper feed unit (AR-D24)	Yes	Yes	Yes	Yes	Yes
2 x 250-sheet paper feed unit (AR-D25)	Yes	Yes	Yes	Yes	Yes
Job separator tray kit (AR-TR4)	Yes	Yes	Yes	Yes	Yes
Dual function board (AR-EB9)	Yes	Standard	Standard	Yes	Standard
256MB expansion memory board (AR-SM5)	Yes	Yes	Yes	Yes	Yes
Facsimile expansion kit (AR-FX11)	Yes	Yes	Yes	Yes	Yes
8MB fax memory (AR-MM9)	Yes*2	Yes*2	Yes*2	Yes*2	Yes*2
Network expansion kit (AR-NB3)	Yes	Yes	Yes	Yes	Yes
PS3 expansion kit (AR-PK1/N)	Yes*1	Yes*1	Yes*1	Yes*1	Yes*1
Barcode font kit (AR-PF1)	Yes*1	Yes*1	Yes*1	Yes*1	Yes*1
Flash memory kit (AR-PF2)	Yes*1	Yes*1	Yes*1	Yes*1	Yes*1

Yes: Can be installed. No: Cannot be installed.

*1 The network expansion kit (AR-NB3) must be installed.

*2 The facsimile expansion kit (AR-FX11) must be installed.

REVERSING SINGLE PASS FEEDER / SINGLE PASS FEEDER

For the names of the parts of the RSPF / SPF, see "PART NAMES AND FUNCTIONS" (page 12).

Specifications

Model		AR-SP6N	AR-RP6N
Acceptable originals	Weight	56 g/m ² to 90 g/m ² (15 lbs. to 24 lbs.)	
	Original sizes	A5 to A3 (5-1/2" x 8-1/2" to 11" x 17")	
	Capacity	Up to 40 sheets (thickness 4 mm (11/64") or less) (for B4 (8-1/2" x 14") or larger originals, up to 30 sheets)	
Detectable original sizes		A5, B5, B5R, A4, A4R, B4, A3 (5-1/2" x 8-1/2"*1, 8-1/2" x 11", 8-1/2" x 11"R, 8-1/2" x 14", 11" x 17")	
Original exchange speed*2		When installed on AR-M161/AR-M162/AR-M165: 16 pages/min. When installed on AR-M206/AR-M207: 20 pages/min.	
Weight		5.0 kg (11.1 lbs.)	5.4 kg (12.0 lbs.)
Dimensions		583 mm (W) x 435 mm (D) x 133 mm (H) (22-61/64" (W) x 17-9/64" (D) x 5-1/4" (H))	

*1 Two-sided scanning is not possible.

*2 During one-sided copying

3

250-SHEET PAPER FEED UNIT / 2 X 250-SHEET PAPER FEED UNIT

- The 250-sheet paper feed unit provides a tray that can hold 250 sheets (80 g/m² (20 lbs.)) of plain paper.
- The 2 x 250-sheet paper feed unit provides two trays that can each hold 250 sheets (80 g/m² (20 lbs.)) of plain paper.

Loading paper in the 250-sheet paper feed unit / 2 x 250-sheet paper feed unit

The method of loading paper is the same as for the paper trays on the machine (see the explanation on page 18).



If you change the size of paper loaded in the tray, you must change the tray's paper size setting. Change the setting as explained in "CHANGING THE PAPER SIZE SETTING OF A TRAY" on page 21.

Specifications

Model	AR-D24	AR-D25
Paper size	B5, B5R, A4, A4R, B4, A3, 8-1/2" x 11"R, 8-1/2" x 11, 8-1/2" x 13", 8-1/2" x 14", 11" x 17"	
Paper capacity	Approximately 250 sheets (80 g/m ² (20 lbs.)) x 1 tray	Approximately 250 sheets (80 g/m ² (20 lbs.)) x 2 trays
Paper weight	56 g/m ² to 90 g/m ² (15 lbs. to 24 lbs.)	
Power supply	Supplied from the machine	
Dimensions	590 mm (W) x 471 mm (D) x 88 mm (H) (23-15/64" (W) x 16-27/64" (D) x 3-15/32" (H))	590 mm (W) x 471 mm (D) x 173.5 mm (H) (23-15/64" (W) x 16-27/64" (D) x 6-27/32" (H))
Weight	5.0 kg (11.0 lbs.)	10.0 kg (22.0 lbs.)

DUAL FUNCTION BOARD

A dual function board can be installed to add a variety of copy functions and enable use of the printer driver for the dual function board, which is a more advanced printer driver than the standard printer driver. For copy functions that can be used, see "CONVENIENT COPY FUNCTIONS" (page 64).

Specification

Model	AR-EB9
Added functions	Sort copy, 2 in 1 / 4 in 1 copying, rotation copy, border erase copying, margin copying, card shot, USB 2.0 port (Hi-speed) printer function for the dual function board, ROPM function, High-speed data transfer
Electronic sort compression method	JBIG
Electronic sort memory	16 MB
Electronic sort scannable pages	100 standard A4 (8-1/2" x 11") originals

STORAGE OF SUPPLIES

Standard supplies for this product that are to be replaced by the user are paper and toner cartridge.

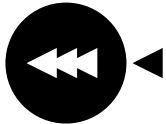
For best copying results, be sure to use only SHARP Genuine Supplies which are designed, engineered and tested to maximize the life and performance of SHARP copiers. Look for the Genuine Supplies label on the toner package.

GENUINE SUPPLIES

PROPER STORAGE

● **Store the supplies in a location that is:**

- clean and dry,
- at a stable temperature,
- not exposed to direct sunlight.

● **Store paper in the wrapper and lying flat.**

Paper stored out of the wrapper or in packages standing on end may curl or get damp, resulting in paper misfeeds.

Supply and Consumables

The supply of spare parts for a repair of the appliance is guaranteed for at least 7 years following the termination of production. Spare parts are those parts of the apparatus which may break down within the scope of the ordinary use of the product - whereas those parts which normally exceed the life of the product are not to be considered as spare parts. Consumables too, are available for 7 years following the termination of production.

Part 2: Copier Operation

4

COPY FUNCTIONS

This chapter explains the basic procedures for making copies, including selection of the copy ratio and other copy settings.

NORMAL COPYING

This section explains how to make a regular copy.

If "Auditing mode" has been enabled (page 23), enter your 5-digit account number.

Copying from the document glass

1 Open the SPF and place the original face down on the document glass.

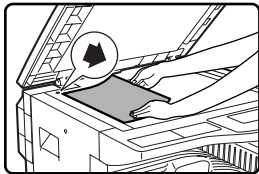

Align the upper left-hand corner of the original with the tip of the ▲ mark.
The original size is automatically detected.



An original up to A3 (11" x 17") can be placed on the document glass.

2 Close the SPF.

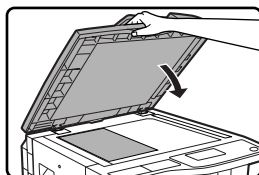

If the original is a non-standard size or the size was not detected correctly, see "SELECTING THE ORIGINAL SIZE" (page 50).

3 Make sure that the desired paper tray is selected.

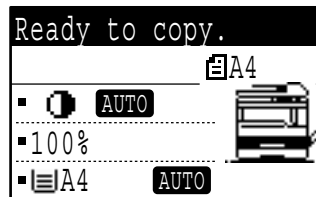

To load paper, see "LOADING PAPER" (page 18).



- If the auto paper select function has been disabled in the key operator programs (page 88), use the [PAPER SELECT] key to select the desired paper size.
- If you wish to use a size of paper different from the size automatically selected by the machine, use the [PAPER SELECT] key to select the desired paper size.
- Paper in a different orientation from the original can be selected if the auto paper select or auto image function has been selected. In this case, the image of the original will be rotated.
- To make a copy of a small original such as a card, follow the procedure in "USING THE BYPASS TRAY TO COPY A SPECIAL SIZE ORIGINAL" (page 51).
- To use the bypass tray, select it manually.

4 Set the number of copies.



If you are making two or more copies each of multiple original pages, you can select the sort function to collate the copies into sets. (Page 64)

5 Press the [START] key (⏻) to begin copying.

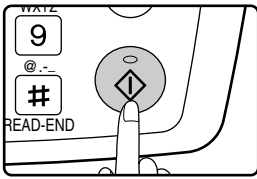

The copy will be delivered to the centre tray.

Note

- The centre tray can hold a maximum of 250 sheets (150 sheets when the job separator tray kit is installed).
- About one minute after copying ends, "Auto clear" (page 18) activates and restores the copy settings to the default settings. The setting for "Auto clear" can be changed in the key operator programs. (Page 83)
- To cancel a copy job in progress, press the [C] key.
- Differences in copy conditions may cause the position of the printed copy image to vary even the copies are of the same original on the same paper. For more information, see "Points concerning the position of the printed copy image" on page 47.

Copying from the SPF

1 Open the SPF and make sure that an original has not been left on the document glass. Gently close the SPF.

2 Adjust the original guides to the size of the original(s).

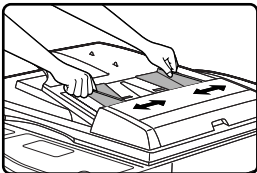

3 Place the original(s) face up in the document feeder tray.

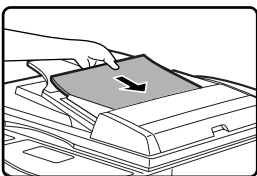

The original size appears in the display and the most suitable paper size is automatically selected.

Insert the stack into the document feeder tray until it stops.

Note

- If the original is a non-standard size or the size was not detected correctly, see "SELECTING THE ORIGINAL SIZE" (page 50).
- If the auto paper select function has been disabled in the key operator programs (page 88), use the [PAPER SELECT] key to select the desired paper size.
- To copy onto paper of a different size, press the [PAPER SELECT] key and select the desired paper size.
- Paper in a different orientation from the original may be selected if the auto paper select or auto image function has been selected. In this case, the image of the original will be rotated.
- To use the bypass tray, select it manually.
- Do not place originals of different sizes together in the document feeder tray. This may cause misfeeds.

4 Set the number of copies.

5 Press the [START] key (⏻) to begin copying.

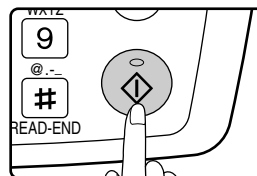

The copies are delivered to the centre tray.

The default output mode for copying from the SPF is sort mode. (Page 64)

The output mode can be changed using the automatic sort selection setting in the key operator programs. (Page 87)

Note

- The centre tray can hold a maximum of 250 sheets (150 sheets when the job separator tray kit is installed).
- About one minute after copying ends, "Auto clear" (page 18) activates and restores the copy settings to the initial settings. The duration of time after which "Auto clear" clears the copy settings can be changed in the key operator programs. (Page 83)
- To stop copying in the middle of a run, press the [C] key. If you find it difficult to remove the original from the document feeder tray, open the feeding roller cover before removing the original. If you pull out the original without opening the feeding roller cover, the original may become dirty.

Stream feeding mode

If stream feeding mode has been enabled in the key operator programs (page 87), the message "Set originals for stream feeding." will appear in the display for 5 seconds after all originals have been fed from the SPF. Any new originals placed in the SPF while this message appears will be fed and copied automatically.

Auto paper select mode

When auto paper select mode is enabled, "AUTO" appears in the paper size display. This function automatically selects paper that is the same size as the original (A5, B5, B5R, A4, A4R, B4, A3, 5-1/2" x 8-1/2", 8-1/2" x 11", 8-1/2" x 11"R, 8-1/2" x 13", 8-1/2" x 14", 11" x 17" paper).

- If a zoom setting is selected after placing the original, the paper size that is appropriate for the zoom setting will be automatically selected.
- Auto paper select mode is cancelled if the auto zoom select function (page 52) is enabled or if a paper tray is selected with the [PAPER SELECT] key. Auto paper select resumes operation when the [CA] key is pressed or when "Auto clear" activates. Auto paper select mode can be disabled in the key operator programs. (Page 88)

Removing the document cover

To copy large originals like newspapers, remove the document cover. To remove the cover, lift it straight up as shown. To replace the cover, do the reverse. The SPF cannot be removed.

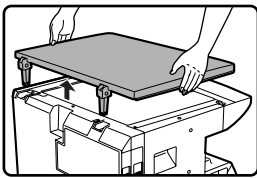

Copying books or originals with folds or creases

Press down on the SPF (or document cover) while copying as shown. If the SPF (or document cover) is not completely closed, shadows may appear on the copy or it may be fuzzy. Straighten originals with folds or creases well before placing.

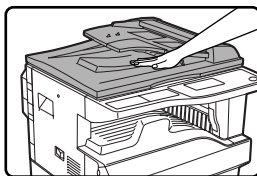

Originals that can be used in the SPF

Originals from A5 to A3 (5-1/2" x 8-1/2" to 11" x 17") in size and 56 g/m² to 90 g/m² (15 lbs. to 24 lbs.) in weight can be used. A maximum of 40 pages can be placed at once. For originals that are B4 or larger (8-1/2" x 14" or larger), a maximum of 30 pages can be placed at once.



- Make sure that there are no paper clips or staples on the original.
- Straighten curled originals before placing them in the document feeder tray. Curled originals may cause misfeeds.
- If the margin shift function is being used, the margin shift settings may need to be changed. (Page 68)

Originals that cannot be used in the SPF

The following originals cannot be used: These may cause misfeeds or smudging and unclear images.

- Transparencies, tracing paper, other transparent or translucent paper, and photographs.
- Carbon paper, thermal paper.
- Originals that are creased, folded, or torn.
- Glued originals, cut-out originals.
- Originals with binder holes.
- Originals printed using an ink ribbon (thermal transfer printing), originals on thermal transfer paper.

Points concerning the position of the printed copy image

Even if the same original is copied onto the same type of paper, differences in the original size, scanning location (document glass or document feeder tray), selected paper tray, enlargement/reduction ratio, and other conditions may cause the position of the printed copy image on the paper to vary.

As shown in the following example, when an original smaller than the paper size (for example, A5 original and A3 paper) is copied from the document glass, the position of the printed copy image on the paper is different when paper from tray 1 is used (1) and paper from the bypass tray is used (2).

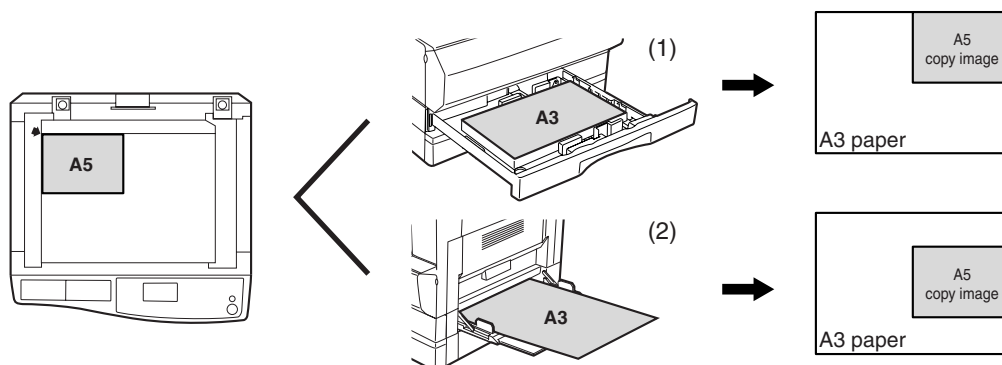

MAKING A COPY DARKER OR LIGHTER

The copy exposure can be adjusted as needed to the original. Three exposure modes are available: "AUTO", "TEXT" and "PHOTO". When "TEXT" or "PHOTO" is selected, the exposure can be manually adjusted to 5 levels.

Auto

This is the default exposure mode. In this mode, the characteristics of an original being copied are "read" by the exposure system and exposure adjustments are made automatically. The exposure level is lowered for coloured areas and background shadows.

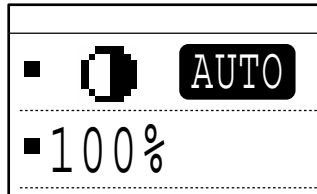

Text/photo

TEXT: This mode enhances low density areas of an original and suppresses high-density background areas to make text more legible.

PHOTO: This mode provides clearer reproduction of halftones in photos.

1 Press the [EXPOSURE] key.

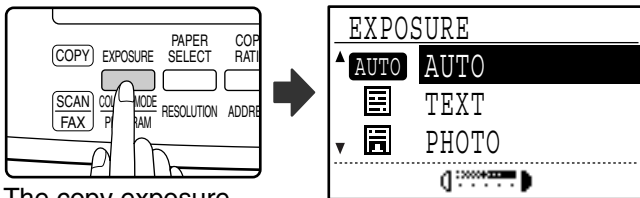

The copy exposure screen will appear.

2 Select the exposure mode that best suits the original with the [▼] or [▲] key.

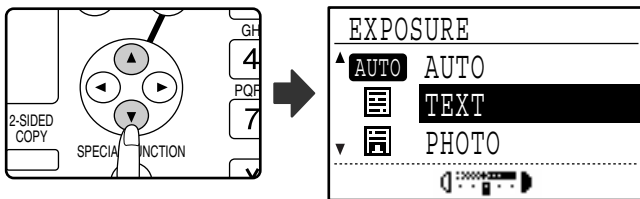

The [EXPOSURE] key can also be pressed to select the exposure mode.



When "PHOTO" is selected, "PHOTO MODE DEFAULT" in the key operator programs can be used to select the method for expressing halftones. (Page 88)

3 Adjust the exposure level as needed with the [◀] or [▶] key.

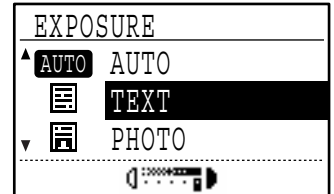
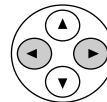

- The exposure level cannot be adjusted when "AUTO" is selected.
- For a darker image, press the [▶] key. For a lighter image, press the [◀] key.
- The default exposure levels for "TEXT" and "PHOTO" can be set in the key operator programs.



Exposure level guidelines

- 1 to 2: Dark originals such as newspapers
- 3: Normal density originals
- 4 to 5: Text written in pencil or light colour text

4 Press the [OK] key.

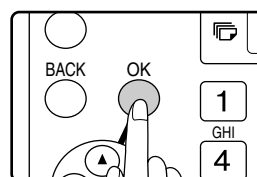

To return to AUTO mode, press the [EXPOSURE] key, select "AUTO" with the [▲] key, and press the [OK] key.

SELECTING THE TRAY

By default the auto paper select function (page 47) operates, and thus the appropriate tray is automatically selected when the original is placed on the document glass or in the document feeder tray, or when the original size is specified. If you wish to use a tray other than the automatically selected tray (for example you wish to enlarge or reduce the copy or use the bypass tray), press the [PAPER SELECT] key to select the desired tray.

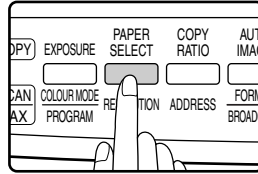

- If the desired paper size does not appear, change the paper in a tray to the desired paper size. (Page 21)
- Automatic ratio selection (page 47) does not operate when the bypass tray is selected.

Auto tray switching

If the tray runs out of paper during copying and there is another tray with the same size of paper and the same feeding orientation (horizontal or vertical), the other tray is automatically selected and copying continues. Auto tray switching can be disabled if needed. (Page 22)

SETTING THE NUMBER OF COPIES

Press the numeric keys to set the number of copies.

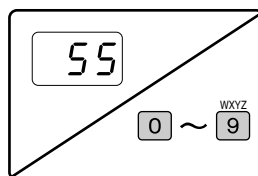

- The set number of copies appears in the display. A maximum of 999 copies (factory default setting) can be set.
- A single copy can be made even if "0" is displayed.



- If you enter the wrong number, press the [C] key and enter the correct number.
- The limit for the number of copies can be changed in the key operator programs. (Page 88)

Important note when making a large number of copies

If the number of sheets output to the centre tray exceed its maximum capacity (250 sheets when a job separator tray kit is not installed, 150 sheets when a job separator tray kit is installed) during a copy job, the copy job will stop temporarily. If this happens, promptly remove the copies and press the [OK] key to resume copying. The copy job will step each time the number of sheets in the centre tray reach its maximum capacity.

Before starting a long copy run, remove any sheets that remain in the centre tray. During output of the copy job, exercise care as the job may stop frequently due to the centre tray becoming full.

SELECTING THE ORIGINAL SIZE

If you loaded a non-standard size* original or the original size was not correctly detected, set the original size manually. Perform the following steps after placing the document in the document feeder tray or on the document glass.



*** Standard sizes:**

The following sizes can be detected correctly: A3, B4, A4, A4R, A5 (11" x 17", 8-1/2" x 14", 8-1/2" x 13", 8-1/2" x 11", 8-1/2" x 11"R, 5-1/2" x 8-1/2"). If a non-standard size original is placed (including special sizes), the closest standard size may be displayed, or the original size may not appear.

1 Press the [SPECIAL FUNCTION] key.

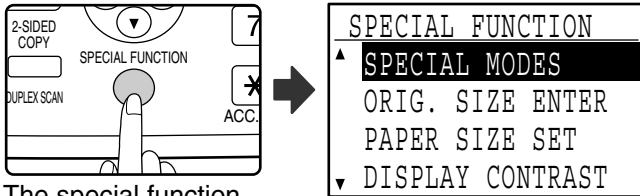

The special function screen will appear.

2 Select "ORIG. SIZE ENTER" from the menu with the [▼] or [▲] key.

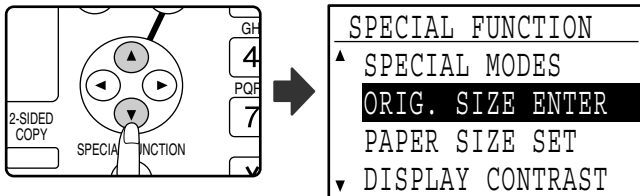

3 Press the [OK] key.

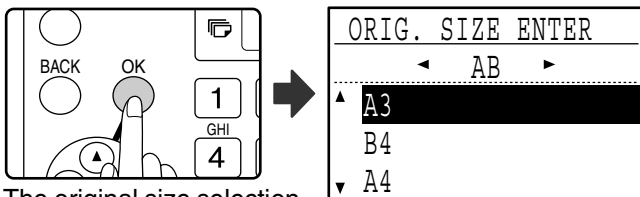

The original size selection screen will appear.

4 Select the original size with the [▼] or [▲] key.

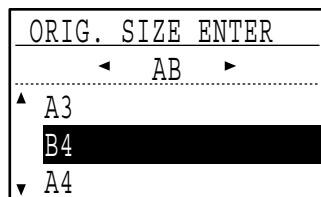
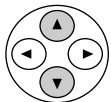

The selected original size is highlighted.

- To select an inch original size, press the [▶] key and go to step 6.
- If you selected "SIZE INPUT", follow steps 4 through 6 of the procedure in "USING THE BYPASS TRAY TO COPY A SPECIAL SIZE ORIGINAL" (page 51) to set the horizontal and vertical dimensions of the original.

5 Press the [OK] key.



You will return to the base screen and the selected original size will appear in the original size display.

Selecting an inch original size

6 Select the original size with the [▼] or [▲] key.

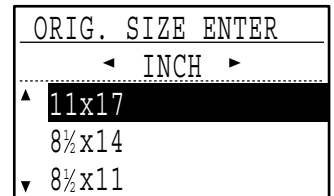
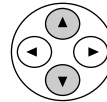

To return to selection of AB original sizes, press the [◀] key to return to step 4.

7 Press the [OK] key.



You will return to the base screen and the selected original size will appear in the original size display.



To cancel an original size selection, press the [CA] key.

USING THE BYPASS TRAY TO COPY A SPECIAL SIZE ORIGINAL

When the bypass tray is being used for copying and an original that is placed on the document glass is detected as being a special size, the display will prompt the user to set the original size. To make a copy in this type of situation, follow the steps below.

1 Load paper in the bypass tray and place the original on the document glass.

2 Touch the [PAPER SELECT] key and then select the bypass tray.

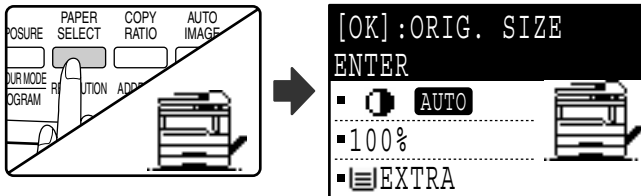

A message will appear asking you whether you wish to set the original size or make the copy without setting it. To make a copy without setting the original size, press the [START] key (Ⓢ). To set the original size, go to step 3.

3 Press the [OK] key.

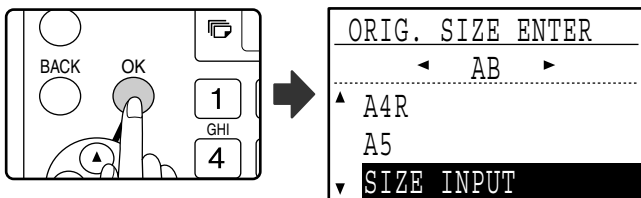

The original size selection screen appears with "SIZE INPUT" selected.

4 Select AB or inches with the [◀] or [▶] key, and then select the original size with the [▼] or [▲] key.

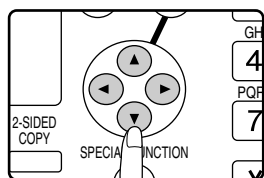

5 Press the [OK] key.

If "SIZE INPUT" was selected in step 4:

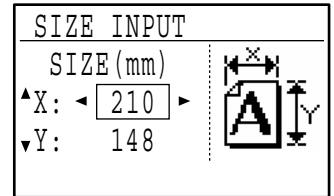

The size entry screen appears and is ready for entry of the width of the original.



If you selected inches in step 4, the screen will be ready for you to enter the width in inches.

If other than "SIZE INPUT" was selected in step 4:

You will return to the base screen. Go to step 8.

6 Select "X" (width) with the [▼] or [▲] key and enter the width with the [◀] or [▶] key, and then do the same for the length (Y).

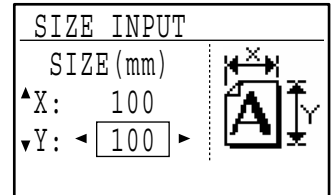
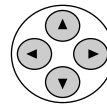

- Any number from 64 mm to 432 mm (2-1/2" to 17") can be entered for the width, and any number from 64 mm to 297 mm (2-1/2" to 11-5/8") can be entered for the length.
- The entered size is retained until the power is turned off, even if "SIZE INPUT" is selected again and the entry screen of step 5 is displayed.

7 Press the [OK] key.



You will return to the base screen.

8 Press the [START] key (Ⓢ).

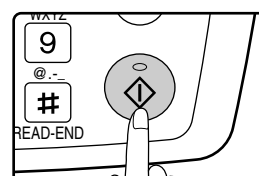

Copying begins.

4

REDUCING OR ENLARGING A COPY

There are three ways to enlarge and reduce copies:

- Automatic selection of a ratio according to the paper size: Auto ratio selection
- Specifying a ratio from 25% to 400%: Preset ratios/zoom
- Selecting the vertical and horizontal ratios separately: XY zoom



When the SPF is being used, the zoom copy ratio range is 50% to 200%.

AUTOMATIC RATIO SELECTION

1 Place the original in the document feeder tray or on the document glass.

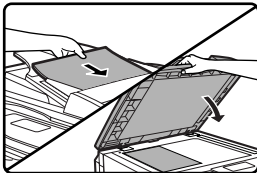

The original size will appear in the display. If the correct size does not appear, see "SELECTING THE ORIGINAL SIZE" (page 50).



Automatic ratio selection can be used when the original size is , A3, B4, A4, A4R, A5, 11" x 17", 8-1/2" x 14", 8-1/2" x 13", 8-1/2" x 11", 8-1/2" x 11"R and 5-1/2" x 8-1/2". It cannot be used for other sizes.

2 Press the [PAPER SELECT] key to select the desired tray.

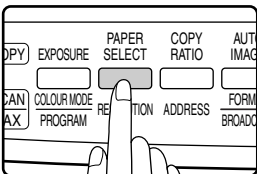

If the bypass tray is selected, automatic ratio selection cannot be used.

3 Press the [AUTO IMAGE] key.

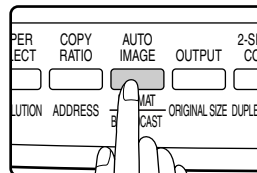

- The copy ratio will be automatically set.
- If the original and paper are in different orientations, the image is automatically rotated to match the paper orientation (rotation copy). However, if enlargement is selected for copying onto a paper size larger than A4 (8-1/2" x 11"), the image will not be rotated.
- Rotation of the image can be disabled in the key operator programs when reducing or enlarging a original. (Page 87)
- If the message "Image edge loss." is displayed, part of the original image may be cut off.

4 Set the number of copies and press the [START] key (⏻).

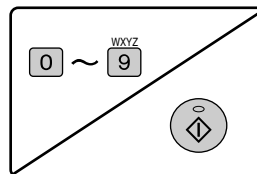

- To cancel automatic ratio selection, press the [AUTO IMAGE] key again.
- When copying from the SPF, automatic ratio selection mode will automatically disable after the [START] key is pressed and the original is scanned.

MANUAL RATIO SELECTION (PRESET COPY RATIOS/ZOOM)

1 Place the original in the document feeder tray or on the document glass.

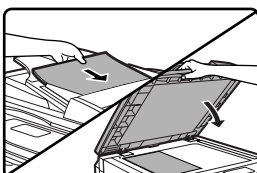

2 Press the [COPY RATIO] key.

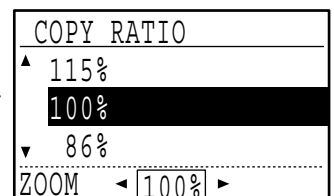
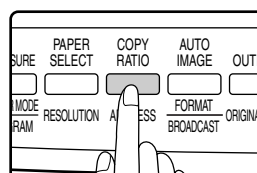

Copy ratios that can be selected will appear.

3 Select a preset ratio with the [▼] or [▲] key, or set the ratio (zoom) with the [◀] or [▶] key.

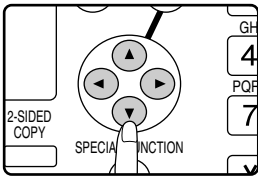

[▲] key: Select a larger preset ratio

[▼] key: Select a smaller preset ratio

[◀] key: Decrease the ratio in increments of 1%

[▶] key: Increase the ratio in increments of 1%

- Preset reduction ratios are: 86%, 81%, 70%, 50% and 25% (95%, 77%, 64%, 50% and 25%). 25% can only be selected when the original is placed on the document glass.
- Preset enlargement ratios are: 115%, 122%, 141%, 200% and 400% (121%, 129%, 141%, 200% and 400%). 400% can only be selected when the original is placed on the document glass.
- Zoom ratios: Any ratio from 25% to 400% (50% to 200% when the original is placed in the document feeder tray) can be set in increments of 1%. You can use the [▼] or [▲] key to set the approximate ratio and then press the [◀] key to decrease the ratio or the [▶] key to increase the ratio.
- To decrease or increase the zoom ratio rapidly, hold down the [◀] or [▶] key. However the value will stop at the preset reduction or enlargement ratios. To move beyond these ratios, release the key and then hold it down again. (Note that if the key auto repeat function has been disabled in the key operator programs, the ratio will not change when the key is held down. (See "DISABLE AUTO KEY REPEAT" on page 84.))
- To cancel a ratio setting, return the ratio to 100% with the [▼] or [▲] key.
- The [COPY RATIO] key can be pressed to return the ratio to 100%.

4 Press the [OK] key.

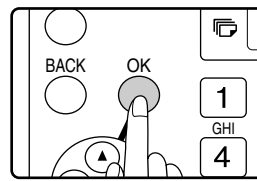

You will return to the base screen.

5 Make sure that the desired paper tray is selected.

If the auto paper select function has been enabled, the appropriate copy paper size will have been automatically selected based on the original size and the selected copy ratio. If the auto paper select function has been cancelled or if you are copying onto a different size paper, use the [PAPER SELECT] key to select the paper tray with the desired paper size.

6 Set the number of copies and press the [START] key (Ⓢ).

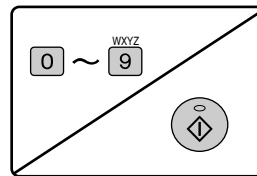

4

SELECTING THE VERTICAL AND HORIZONTAL COPY RATIOS SEPARATELY (XY zoom copying)

Separate ratio settings can be selected for the length and width of a copy.

Example: Reduction only in the horizontal direction

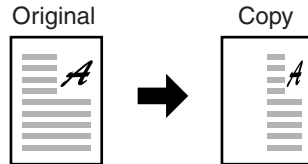

- This feature cannot be used with the 2 in 1 / 4 in 1 feature or card shot feature (when the dual function board is installed).
- To use the XY zoom feature and the dual page copy feature simultaneously, set the dual page copy feature first and then the XY zoom feature. (Enlargement cannot be set.)
- If automatic ratio selection has been selected, the XY zoom feature cannot be selected. If the XY zoom feature is selected, automatic ratio selection cannot be selected.
- Ratios that can be selected are 25% to 400% (50% to 200% when the SPF is used).

1 Place the original in the document feeder tray or on the document glass.

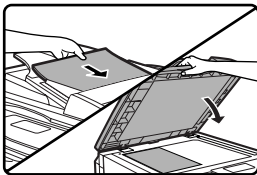

2 Press the [SPECIAL FUNCTION] key.

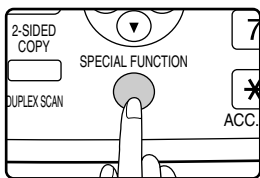

The special function screen will appear.

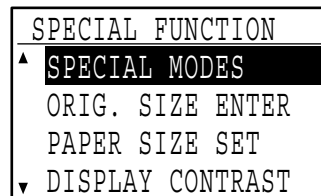

4 Select "XY ZOOM" with the [▼] or [▲] key.

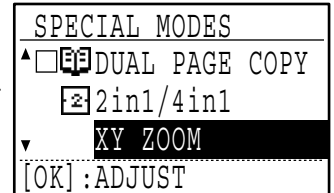
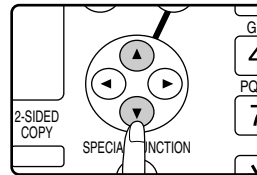

5 Press the [OK] key.

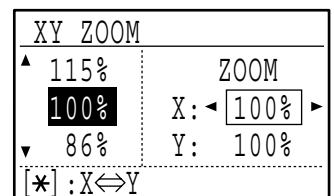

The XY zoom screen will appear, ready for selection of the X (horizontal) ratio.

3 Press the [OK] key.

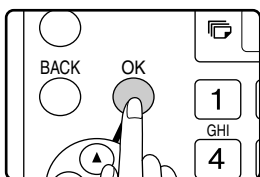

The special modes screen will appear.

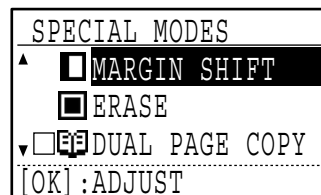

6 Set the horizontal ratio with the [▼], [▲], [◀], or [▶] keys.

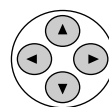

A preset ratio can be selected with the [▼] or [▲] keys. The ratio can be adjusted in increments of 1% with the [◀] or [▶] keys.

7 Press the **[*]** key.

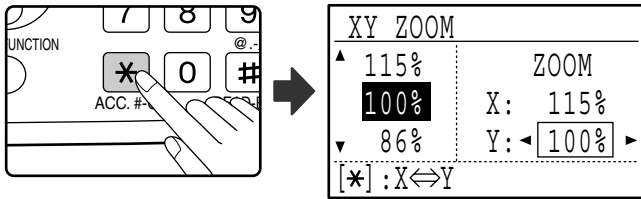

The vertical ratio can now be selected.

8 Set the vertical ratio with the **[▼]**, **[▲]**, **[◀]**, or **[▶]** keys.

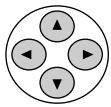

A preset ratio can be selected with the **[▼]** or **[▲]** keys. The ratio can be adjusted in increments of 1% with the **[◀]** or **[▶]** keys. To change the copy ratio in the horizontal direction again, press the **[*]** key.

9 Press the **[OK]** key.

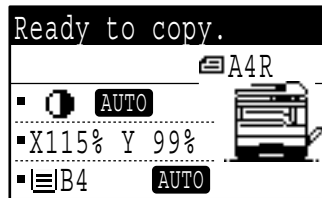

You will return to the base screen.

10 Make sure that the desired paper tray is selected.

If the auto paper select function has been enabled, the appropriate copy paper size will be automatically selected based on the original size and the selected copy ratios. Image rotation will take place if necessary.

11 Select any other copy settings as needed and press the **[START]** key **(⏻)**.

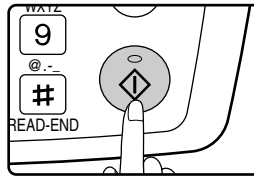

If the **[COPY RATIO]** key is pressed when XY zoom ratios are set, the following screen appears.



To cancel the XY zoom ratio settings, select "OFF" and press the **[OK]** key. To adjust the XY zoom copy ratios, select "ADJUST" and press the **[OK]** key.

TWO-SIDED COPYING

TWO-SIDED COPYING

The machine is capable of the following types of automatic two-sided copying. The copy paper is turned over automatically, allowing two-sided copying to be accomplished with ease.

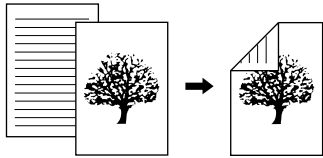
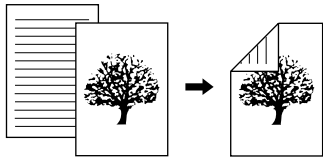
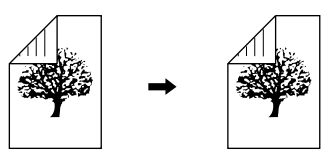
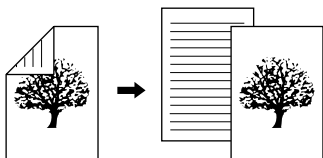
Two-sided copy type	Model	AR-M161/AR-M162	AR-M165/AR-M206/AR-M207	Page
One-sided originals to two-sided copies (using the SPF) 		No	Yes* ¹	57
One-sided originals to two-sided copies (using the document glass) 		No	Yes	58
Two-sided originals to two-sided copies (using the RSPF) 		No	Yes* ²	59
Two-sided originals to one-sided copies (using the RSPF) 		No	Yes* ²	60

*1 The optional single pass feeder (AR-SP6N) or reversing single pass feeder (AR-RP6N) is required.

*2 The optional reversing single pass feeder (AR-RP6N) is required.



- If you are using the AR-M161/AR-M162, see "TWO-SIDED COPIES USING THE BYPASS TRAY" on page 61.
- There are restrictions on the paper that can be used for automatic two-sided copying. See "Paper that can be used for automatic 2-sided printing" on page 18.
- Automatic two-sided copying is not possible when the bypass tray is used.

TWO-SIDED COPYING OF ONE-SIDED ORIGINALS

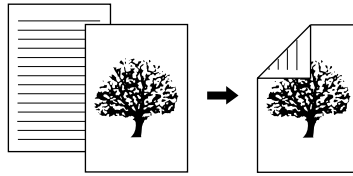

- Paper sizes that can be used are A3, B4, A4, A4R, B5, B5R, A5, 11" x 17", 8-1/2" x 14", 8-1/2" x 13", 8-1/2" x 11" and 8-1/2" x 11"R.
- Automatic two-sided copying is not possible when the bypass tray is used.

Copying from the SPF

- 1** Make sure that an original does not remain on the document glass, and then adjust the original guides to the width of your originals and place the originals face up in the document feeder tray.

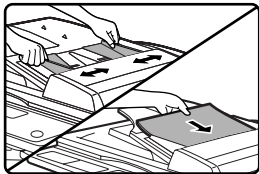

If you placed an odd number of originals, the last copy will be one-sided.

- 2** Press the [2-SIDED COPY] key.

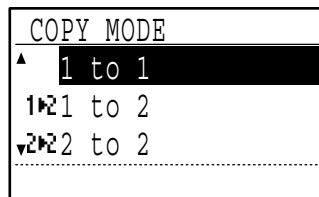
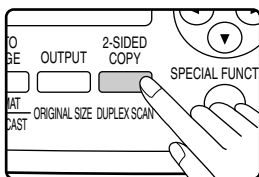

The duplex mode selection screen appears.

- 3** Select "1 to 2" with the [▼] or [▲] key, or with the [2-SIDED COPY] key.

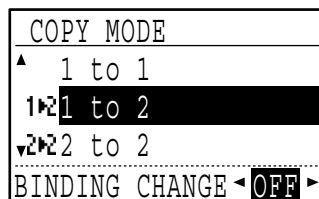
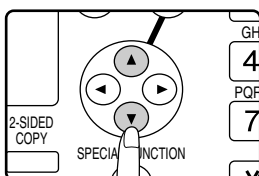

- 4** If you wish to have the orientation of the image on the back of the copy paper be opposite the orientation of the image on the front, set "BINDING CHANGE" to "ON" with the [◀] or [▶] key.

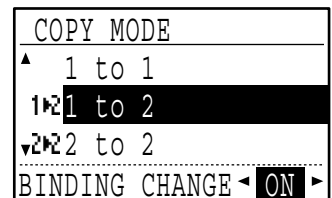
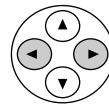

If the copies are to be bound at the top, reversing the orientations of the images on the front and back sides of each copy will result in a uniform orientation when the bound copies are viewed (note that this may depend on the orientation of the originals).

- 5** Press the [OK] key.

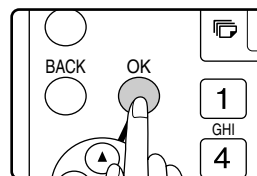

You will return to the base screen.

- 6** Set the number of copies and press the [START] key (Ⓢ).

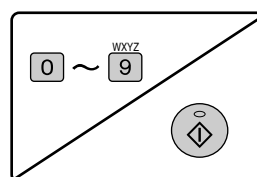

To stop copying in the middle of a run, press the [C] key.

Copying from the document glass

1 Place the original for the front side of the copy on the document glass, and close the SPF.

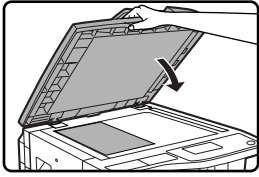

2 Press the [2-SIDED COPY] key.

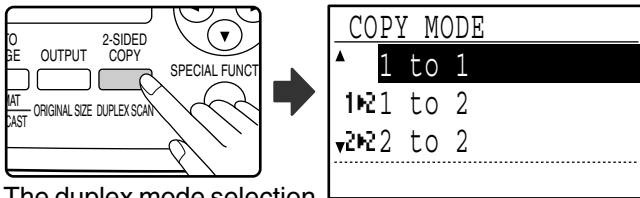

The duplex mode selection screen appears.

3 Select "1 to 2" with the [▼] or [▲] key, or with the [2-SIDED COPY] key.

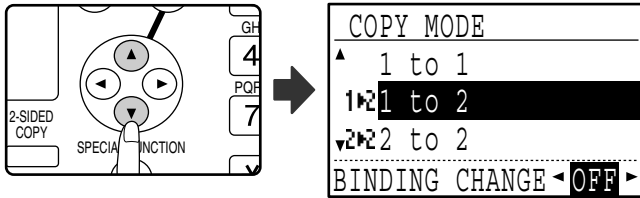

4 If you wish to have the orientation of the image on the back of the copy paper be opposite the orientation of the image on the front, set "BINDING CHANGE" to "ON" with the [◀] or [▶] key.

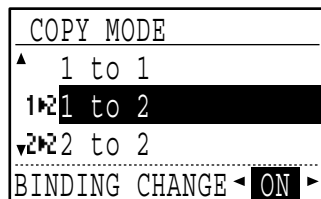
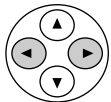

5 Press the [OK] key.

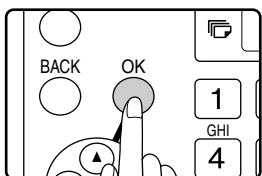

You will return to the base screen.

6 Make sure that the desired paper tray is selected.

7 Set the number of copies and press the [START] key (Ⓢ).

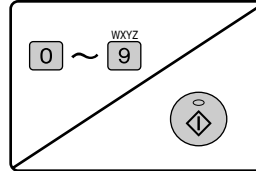

8 Remove the first original and then place the original for the back side of the copy on the document glass. Close the SPF and press the [START] key (Ⓢ).

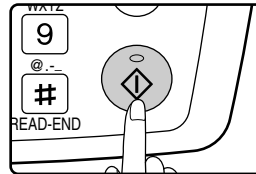

- The copy will be delivered to the centre tray.
- To cancel two-sided copying, press the [C] key.
- To cancel two-sided (duplex) copy mode, press the [2-SIDED COPY] key to select "1 to 1" and then press the [OK] key.
- When making two-sided copies of an odd number of originals, touch the [READ-END] key (Ⓢ) after scanning the last original.

TWO-SIDED COPIES OF TWO-SIDED ORIGINALS (ONLY WHEN USING THE RSPF)

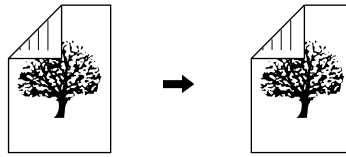

- Paper sizes that can be used are A3, B4, A4, A4R, B5, B5R, A5, 11" x 17", 8-1/2" x 14", 8-1/2" x 13", 8-1/2" x 11" and 8-1/2" x 11"R.
- Automatic two-sided copying is not possible when the bypass tray is used.
- This copy function cannot be used in combination with dual page copy.

1 Make sure that an original does not remain on the document glass, and then adjust the original guides to the width of your originals and place the originals face up in the document feeder tray.

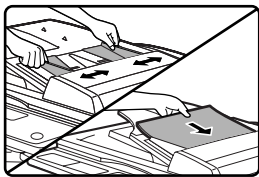

2 Press the [2-SIDED COPY] key.

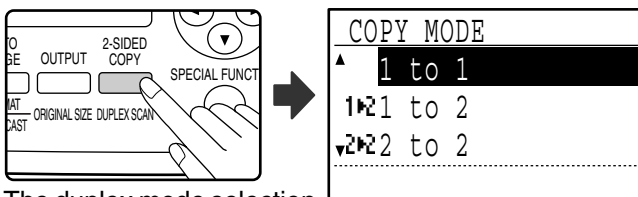

The duplex mode selection screen appears.

3 Select "2 to 2" with the [▼] or [▲] key, or with the [2-SIDED COPY] key.

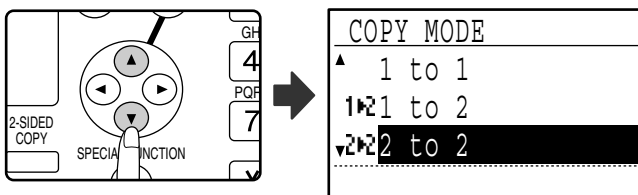

4 Press the [OK] key.

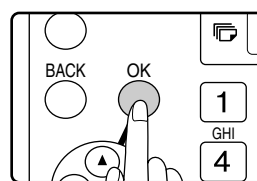

You will return to the base screen.

5 Set the number of copies and press the [START] key (Ⓢ).

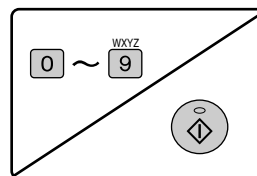

To stop copying in the middle of a run, press the [C] key.



Note Do not touch an original (A) that is on the reversing tray. Doing so may cause a misfeed.

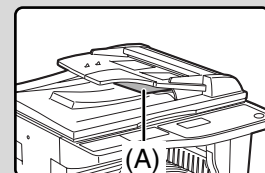

4

ONE-SIDED COPIES OF TWO-SIDED ORIGINALS (ONLY WHEN USING THE RSPF)

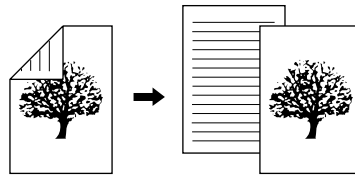

- Paper sizes that can be used are A3, B4, A4, A4R, B5, B5R, A5, 11" x 17", 8-1/2" x 14", 8-1/2" x 13", 8-1/2" x 11" and 8-1/2" x 11"R.
- Automatic two-sided copying is not possible when the bypass tray is used.
- This copy function cannot be used in combination with dual page copy.

1 Make sure that an original does not remain on the document glass, and then adjust the original guides to the width of your originals and place the originals face up in the document feeder tray.

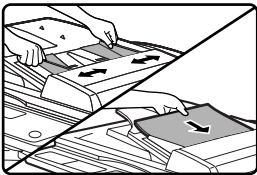

2 Press the [2-SIDED COPY] key.

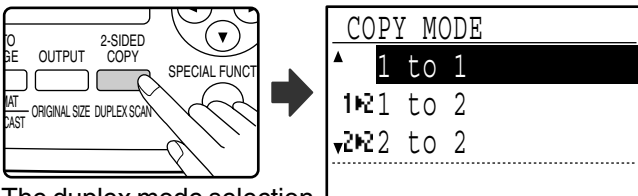

The duplex mode selection screen appears.

3 Select "2 to 1" with the [▼] or [▲] key, or with the [2-SIDED COPY] key.

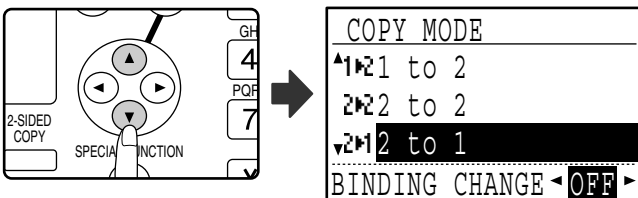

4 If you wish to have the orientation of the back image be opposite the orientation of the front image, set "BINDING CHANGE" to "ON" with the [◀] or [▶] key.

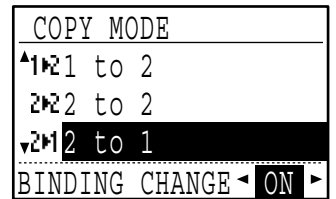
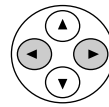

If the copies are to be bound at the top, reversing the orientations of the front and back images will result in a uniform orientation when the bound copies are viewed (note that this may depend on the orientation of the originals).

5 Press the [OK] key.

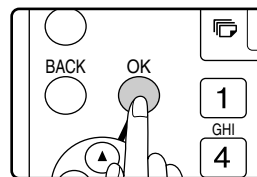

You will return to the base screen.

6 Set the number of copies and press the [START] key (Ⓢ).

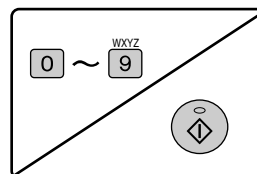

To stop copying in the middle of a run, press the [C] key.



Note Do not touch an original (A) that is on the reversing tray. Doing so may cause a misfeed.

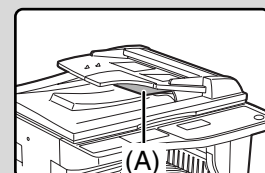

TWO-SIDED COPIES USING THE BYPASS TRAY

Follow the steps below to perform two-sided copying manually.

Example: Copying original A and original B onto both sides of the paper

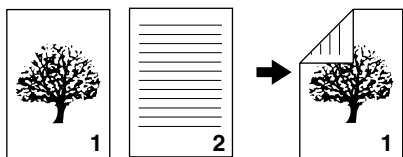

If you are using the AR-M165/AR-M206/AR-M207

The AR-M165/AR-M206/AR-M207 is equipped standard with an automatic two-sided copying function that automatically turns over the paper. If paper in "Paper that can be used for automatic 2-sided printing" on page 18 is used, this enables easier two-sided copying than using the bypass tray. See "TWO-SIDED COPYING" on page 56.

1 Copy original A.

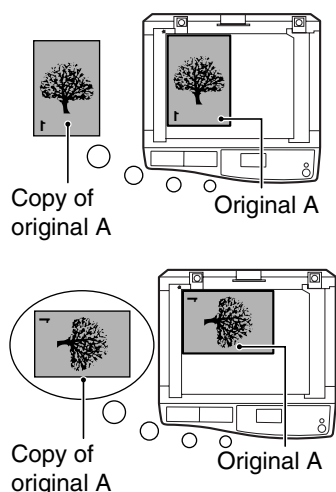

3 Turn the copy of original A over, and without changing the position of the edge closest to you, insert it in the bypass tray.

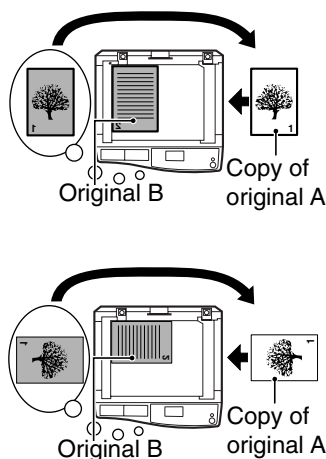

Insert the paper all the way in.

2 Place original B as shown below.

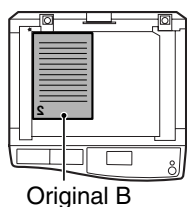

Vertically-oriented original:

If the original is oriented vertically, place it in the same orientation as original A.

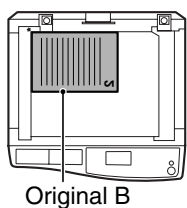

Horizontally-oriented original:

Place in the opposite orientation (rotated 180 degrees) to that of original A.

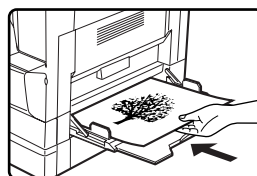

- Copies made on the back side of paper should always be made one sheet at a time using the bypass tray.
- Straighten curled or wavy paper before using it. Curled paper may cause misfeeds, creases, or a poor-quality image.

4 Select the bypass tray with the [PAPER SELECT] key and then press the [START] key (⏻).

The copies are delivered to the centre tray.

4

DUAL PAGE COPY

(Dual page copy)

The dual page copy function produces separate copies of open bound original pages. This function is convenient when you wish to make a separate copy of each page of a book or other bound document.

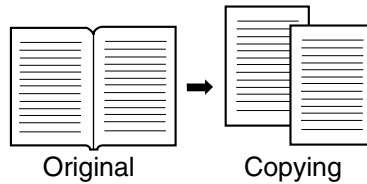

Note

- A4 (8-1/2" x 11") paper can be used for dual page copying.
- When rotation copy is enabled, A4R (8-1/2" x 11"R) paper can also be used.
- When used in combination with XY zoom copying, enlargement is not possible.
- Dual page copying cannot be used in combination with the following functions:
 - 2 in 1 / 4 in 1 copying
 - Centre erase / Edge + Centre erase
 - Enlargement
 - Automatic ratio selection
 - Card shot
 - 2-sided to 2-sided copy, 2-sided to 1-sided copy
- Dual page copying cannot be selected when an original is placed in the SPF.

1 Place the original on the document glass, aligning the division between the pages with the size marker (see below). Close the SPF.

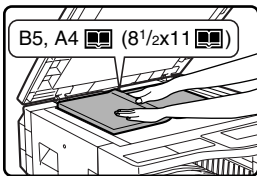

Copying will begin from the page to the right of the size marker.

Note

To keep the copies in the correct page order when performing dual page copying over multiple pages, make sure that the original is always placed on the document glass with the smaller page number to the right.

2 Press the [SPECIAL FUNCTION] key.

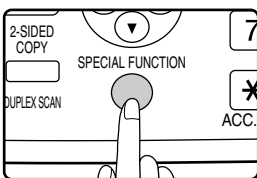

The special function screen will appear.

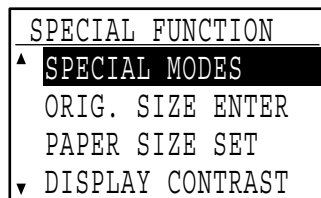

4 Select "DUAL PAGE COPY" with the [▼] or [▲] key.

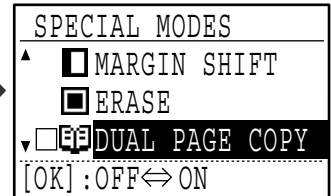
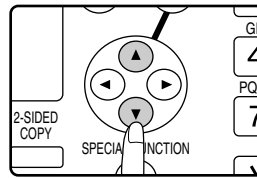

5 Press the [OK] key.



A checkmark appears in the "DUAL PAGE COPY" checkbox in the special modes screen and you return to the base screen.

6 Make sure that the paper tray with A4 (8-1/2" x 11") paper is selected.

A4R (8-1/2" x 11"R) paper can also be used if rotation copying is possible in auto paper select mode.

7 Select any other copy settings as needed and press the [START] key (Ⓢ).

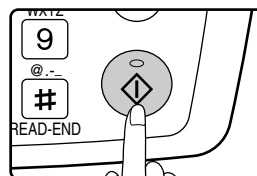

3 Press the [OK] key.

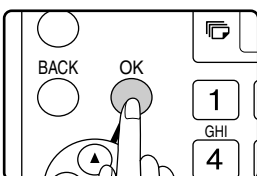

The special modes screen will appear.

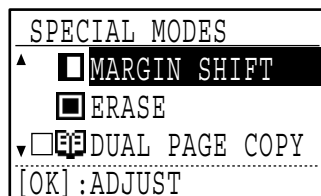

To cancel dual page copy, select "DUAL PAGE COPY" (which has a checkmark) in the special modes screen once again and press the [OK] key.

INTERRUPTING A COPY RUN

(Interrupt copying)

A copy run can be temporarily interrupted to allow another copy job to be performed. (Interrupt copying)
When the other job is finished, the copy run will resume using the original copy settings.

- Interrupt copying is not possible when the document glass is being used for a copy job and "NO SORT" is selected.
- When 2 in 1 or 4 in 1 is selected, interrupt copying is not possible.
- Sort copying, 2 in 1, and 4 in 1 (when the dual function board is installed) and automatic two-sided copying cannot be used for an interrupt copy job.

Configuring settings in the key operator programs, use as a scanner, and fax transmission are also not possible.

1 Press the [INTERRUPT] key (⊖).

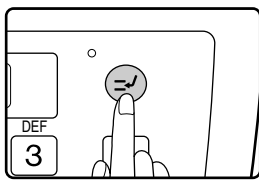

If the [INTERRUPT] key (⊖) is pressed, copying will stop and the settings will temporarily return to the default settings after the copy in progress has been completed.

The INTERRUPT indicator will blink until the current copy run stops.



Note If you press the [INTERRUPT] key (⊖) when auditing mode is enabled, "Enter your account number." will appear in the display. Enter your account number using the numeric keys. The pages copied during interrupt copying will be added to the count of the entered account number. (Page 79)

2 When the copy run stops, remove the previous original(s) and place the original(s) of the interrupt copy job.

3 Select copy settings as needed.

4 Set the number of copies and then press the [START] key (⊕).

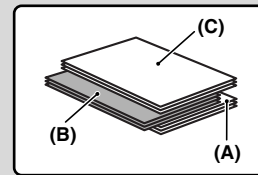
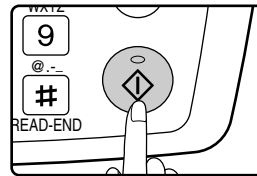

The interrupt copies will be offset from the previous copies. (Offset function)

The offset function can be disabled in the key operator programs. (Page 82)

(A): Copies made before the interrupt copy job

(B): Interrupt copies

(C): Copies made after the interrupt copy job

5 When the copy job is finished, press the [INTERRUPT] key (⊖) to end interrupt mode and remove the original(s).

The INTERRUPT indicator will turn off, indicating that the interrupt function is no longer operating. The copy settings will automatically revert to the settings selected for the copy run before the run was interrupted.

6 Replace the previous original(s) and press the [START] key (⊕).

The interrupted copy run will resume.

4

5

CONVENIENT COPY FUNCTIONS

This chapter explains convenient copy functions that can be used when the dual function board (AR-EB9) is installed.

Select convenient copy functions after pressing the [COPY] key to select copy mode.

ROTATING THE IMAGE 90 DEGREES

(Rotation copy)

When "Auto paper select mode" or "automatic ratio selection" are in operation and the original is placed in a different orientation (vertical or horizontal) from the paper, the original image will be automatically rotated 90 degrees to enable correct copying onto the paper.

This function is convenient for copying B4 or A3 (8-1/2" x 14" or 11" x 17") originals, which can only be placed horizontally, onto paper that is loaded vertically.

The rotation copy function is initially enabled. It can be disabled in the key operator programs. (Page 87)



- The rotation copy function cannot be used in combination with the margin shift function.
- Rotation copy will not operate when a copy is enlarged to a paper size greater than A4 (8-1/2" x 11"). In this case, place the original in the same orientation as the paper.
- Even if rotation copy is disabled in the key operator programs, rotation copy will function when the 2 in 1 or 4 in 1 function is selected (page 66).

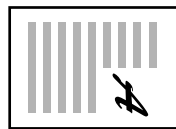

Orientation of the original

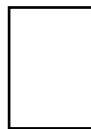

Orientation of the original



Copy

SORT MODE

Copies of multiple original pages can collated into sets.



The dual function board can scan approximately 100 standard originals (A4 (8-1/2" x 11")), however, the number will vary for photos and other types of originals.

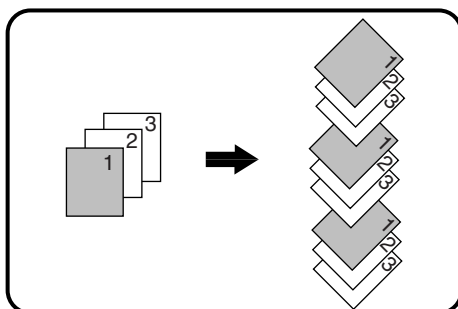

Sort

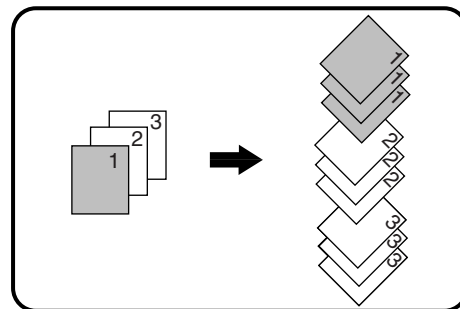

No sort

1 Place the originals in the document feeder tray or the first original on the document glass.

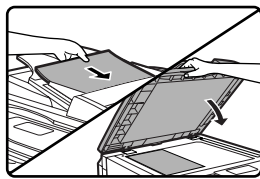

If the originals are placed in the document feeder tray, sort mode will be automatically selected. This can be changed to no sort in the key operator programs. (Page 87)

If the first original is placed on the document glass, no sort mode will be automatically selected.

2 Press the [OUTPUT] key.

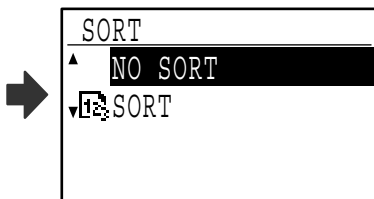
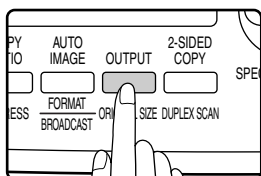

The output mode selection screen will appear.

3 Select "NO SORT" or "SORT" with the [▼] or [▲] key, or with the [OUTPUT] key.

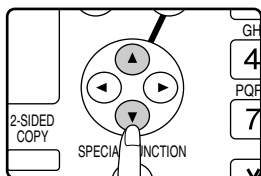

4 Press the [OK] key.

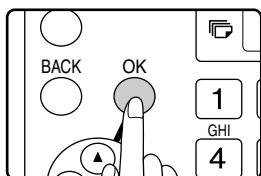

You will return to the base screen.

5 Select other copy settings as needed and press the [START] key (Ⓢ).

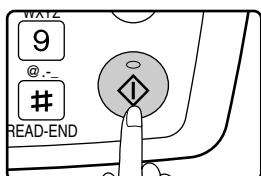

If you placed the originals in the document feeder tray in step 1, copying will start. If you selected "SORT" in step 3 and placed the first original on the document glass, follow steps 6 and 7. Note that if you selected "NO SORT" in step 3, copying will begin.

6 When the START indicator lights, replace the original with the next original and press the [START] key (Ⓢ).



Repeat step 6 until all originals have been scanned.

7 When all originals have been scanned, press the [READ-END] key (Ⓢ).

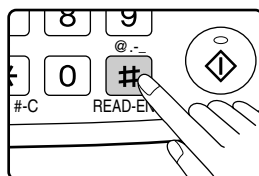

- Copying will start.
- If the memory becomes full while the originals are being scanned, "Memory is full." will appear in the display. To start copying the originals that have been scanned to that point, press the [START] key (Ⓢ). To cancel the copy job, press the [CA] key.
- The optional memory board (AR-SM5) can be installed to increase the number of originals that can be scanned. The memory can be expanded up to a maximum of 272 MB (the amount expanded is 256 MB).

Offset function

This function offsets each set of copies from the previous set in centre tray, making it easy to separate sets of copies. The offset function can be disabled in the key operator programs. (Page 82)

Offset function enabled Offset function disabled

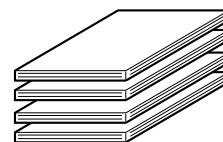
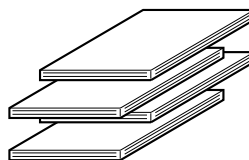

COPYING MULTIPLE ORIGINALS ONTO A SINGLE SHEET OF PAPER (2 in 1 / 4 in 1 copy)

Multiple originals can be copied onto a single sheet of paper in a selected layout.

This function is convenient when you wish to present multiple pages in a compact format, or show a view of all pages in a document.

One of two layouts can be selected for 2 in 1 copy, and one of four layouts can be selected for 4 in 1 copy.

Border line selections are solid line, broken line, or none.

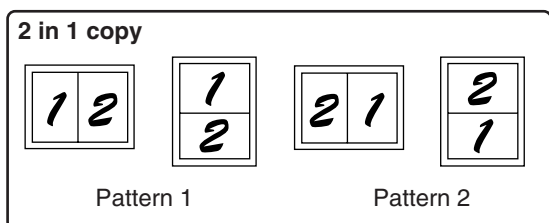

2 in 1 copy layouts

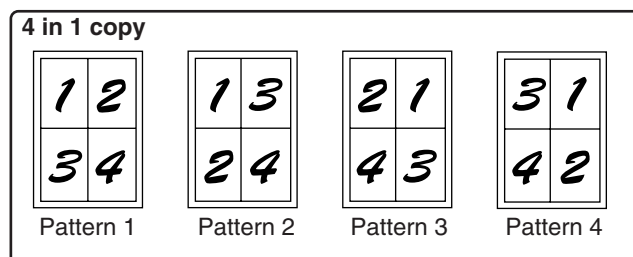

4 in 1 copy layouts

- 2 in 1 / 4 in 1 copy cannot be used in combination with the following functions. The function selected first will take precedence. However, 2 in 1 / 4 in 1 copy will take precedence over XY zoom.
Dual page copy, XY zoom, edge erase, margin shift, card shot
- A special paper size cannot be used for 2 in 1 / 4 in 1 copy.
- 2 in 1 / 4 in 1 copy cannot be selected for an interrupt copy job. Interrupt copying is not possible during a 2 in 1 / 4 in 1 copy job.
- An appropriate ratio setting will be automatically selected based on the original size, the paper size, and the selected number of images. When using the document glass, reduction is possible to 25%. When using the SPF, reduction is possible to 50%. Certain combinations of original size, paper size, and number of images may result in images being cut off.
- Even if "Rotation copy" is disabled in the key operator programs, the images may be rotated if needed depending on the orientation of the originals and the orientation of the paper.

1 Place the originals in the document feeder tray or the first original on the document glass.

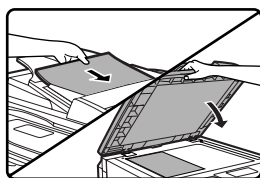

2 Press the [PAPER SELECT] key to select the desired paper tray.

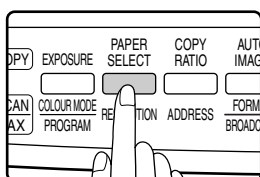

The bypass tray cannot be selected.

3 Press the [SPECIAL FUNCTION] key.

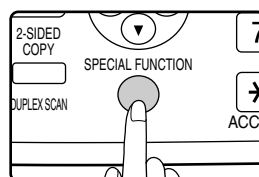

The special function screen will appear.

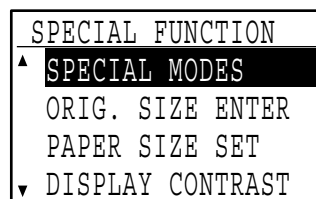

4 Press the [OK] key.

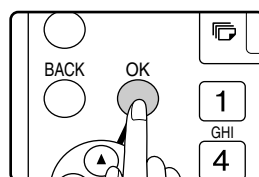

The special modes screen will appear.

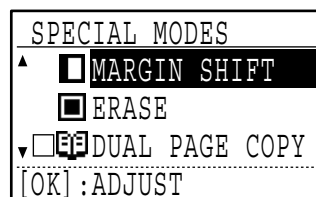

5 Select "2in1/4in1" with the [▼] or [▲] key.

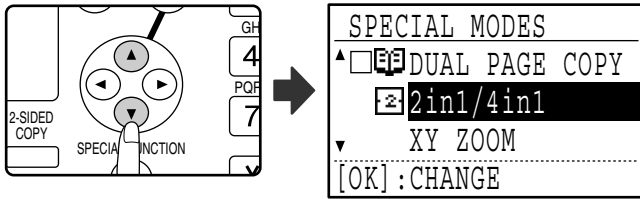

6 Press the [OK] key.

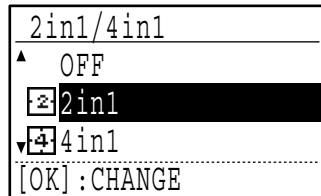

The 2 in 1 / 4 in 1 selection screen will appear.

7 Select "2in1" or "4in1" with the [▼] or [▲] key.

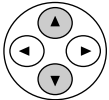

8 Press the [OK] key.

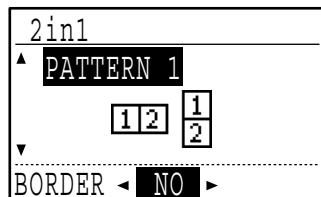

The settings for 2 in 1 or 4 in 1 will appear.

9 Select the layout with the [▼] or [▲] key.

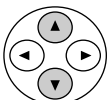

For the layouts that can be selected, see "2 in 1 copy layouts" or "4 in 1 copy layouts" on page 66.

10 Select the borderline setting with the [◀] or [▶] key.

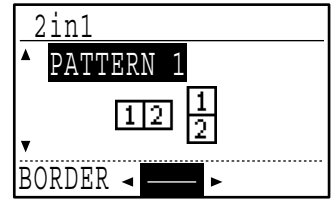
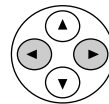

Select solid line, broken line, or none.

11 Press the [OK] key.



You will return to the base screen.

12 Select other copy settings as needed and then press the [START] key (Ⓢ).

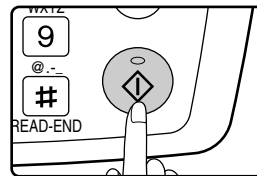

- The copy ratio will be set automatically.
- If you placed the originals in the document feeder tray, copying will start after all originals are scanned.
- If you placed the first original on the document glass, go to the next step.

13 When the START indicator lights, replace the original with the next original and then press the [START] key (Ⓢ).



Repeat step 13 until all originals have been scanned.

- Copies will be output each time two originals for 2 in 1 copy or four originals for 4 in 1 copy have been scanned.
- To start copying before all originals have been scanned (after only one original has been scanned for 2 in 1 or after three originals or less have been scanned for 4 in 1), press the [READ-END] key (Ⓢ).
- To cancel the 2 in 1 or 4 in 1 settings, select "OFF" in step 7.

CREATING MARGINS WHEN COPYING (Margin shift)

The margin shift function shifts the image to create a margin at the edge of the paper. By default the function creates a 10 mm (1/2") margin at the left edge of the paper.

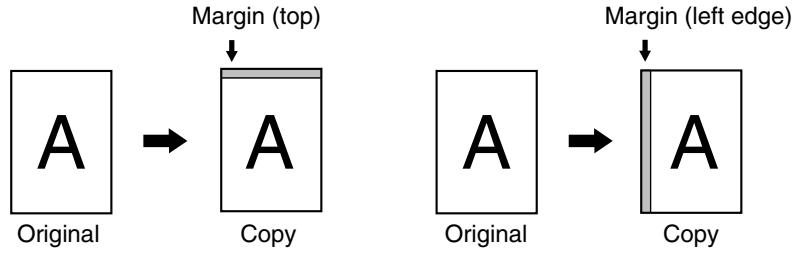

- You can select whether to create a margin at the top edge or at the left edge of the paper.
- Five selections are available for the margin width: 0 mm, 5 mm, 10 mm, 15 mm, 20 mm (0", 1/4", 1/2", 3/4", 1"). (The default setting is 10 mm (1/2").)
- When making two-sided copies, a margin is created at the selected edge on the front side of the paper, and a margin is created on the back side of the paper.
- Margin shift cannot be used in combination with 2 in 1 / 4 in 1 copy (page 66).
- Margin shift cannot be used in combination with card shot (page 71).
- When margin shift is selected, rotating copying will not operate even if the condition for rotate copying is met.
- The default margin shift setting can be changed in the key operator programs. (Page 86)

1 Place the original in the document feeder tray or on the document glass.

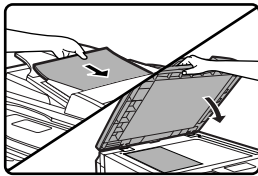

- When a left-edge margin is selected and you are copying from the document feeder tray, place the original face up so that the margin edge is to the left.

When a left-edge margin is selected and you are copying from the document glass, set the original face down so that the margin edge is to the right.

- When a top-edge margin is selected, place the original with the margin edge toward the rear of the document feeder tray or the document glass.

2 Press the [SPECIAL FUNCTION] key.

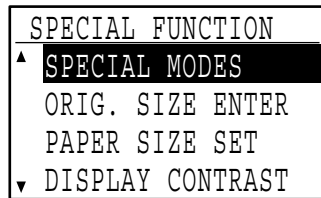
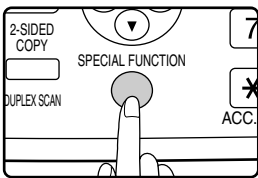

The function screen appears with "SPECIAL MODES" selected.

3 Press the [OK] key.

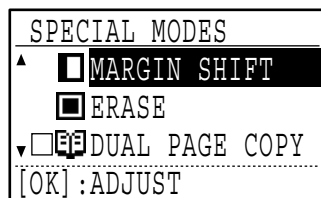
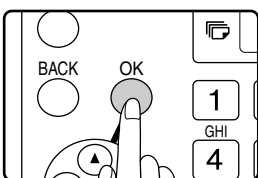

The special modes screen will appear with "MARGIN SHIFT" selected.

4 Press the [OK] key.

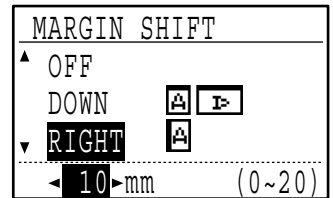

The settings for margin shift will appear.

5 Select the margin location with the [▼] or [▲] key and select the width with the [◀] or [▶] key.

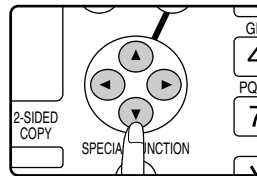

- Select "DOWN" or "RIGHT" for the margin location.
- If you select 0 mm (0"), the printed result is the same as when "OFF" is selected.

6 Press the [OK] key.



You will return to the base screen.

7 Select other copy settings as needed and press the [START] key (Ⓢ).

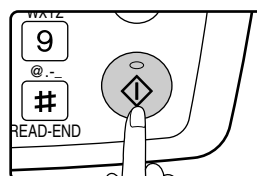

To turn off the margin shift function, select the margin shift feature again and select "OFF".

ERASING SHADOWS AROUND THE EDGES OF A COPY (Erase copy)

This feature is used to erase shadows that appear around the edges of copies of books and other thick originals. (Edge erase)

The feature can also erase the shadow that appears down the centre of books and other originals that open up. (Centre erase)

Both the shadow lines around the edges of copies and the shadow at the centre can be erased. (Edge + Centre erase)

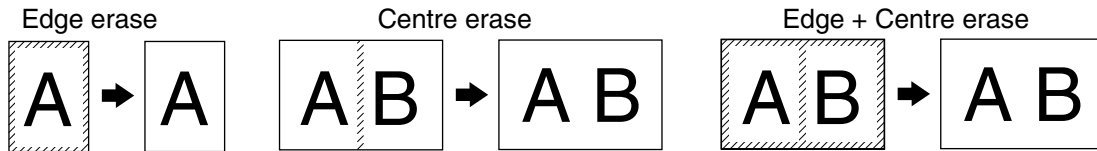

- Five selections are available for the erasure width: 0 mm, 5 mm, 10 mm, 15 mm, 20 mm (0", 1/4", 1/2", 3/4", 1"). (The default setting is 10 mm (1/2").)
- Centre erase / Edge + Centre erase cannot be used in combination with dual page copy (page 62).
- Edge erase cannot be used in combination with 2 in 1 / 4 in 1 copy (page 66).
- Edge erase cannot be used when paper is fed from the bypass tray.
- Edge erase cannot be used in combination with card shot (page 71).
- Edge erase cannot be used when copying a special size original.
- Note that if the width of the erasure is too large, the edge of the image may be partially erased.
- The default setting for the erasure width can be changed. (Page 86)

1 Place the original in the document feeder tray or on the document glass.

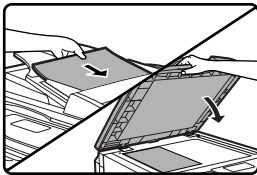

2 Press the [SPECIAL FUNCTION] key.

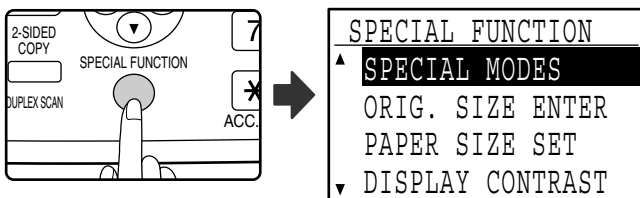

The function screen appears with "SPECIAL MODES" selected.

3 Press the [OK] key.

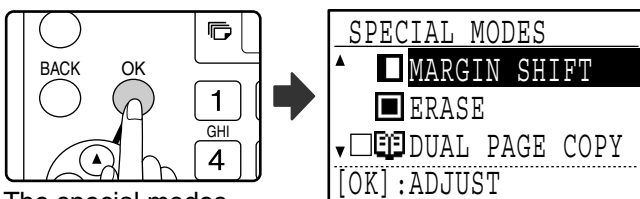

The special modes screen will appear.

4 Select "ERASE" with the [▼] or [▲] key.

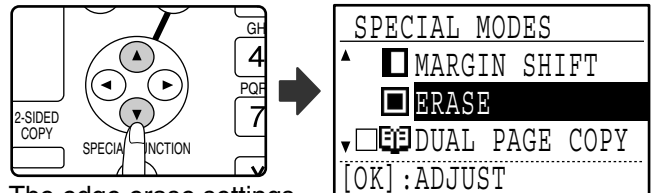

The edge erase settings screen will appear.

5 Press the [OK] key.

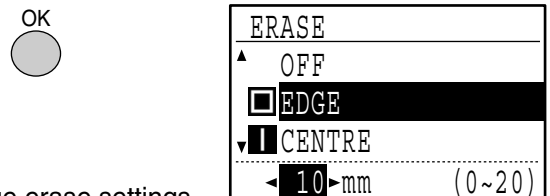

The edge erase settings screen will appear.

6 Select the desired erase mode with the [▼] or [▲] key.

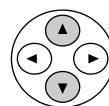

"EDGE", "CENTRE" or "EDGE+CENTRE" can be selected.

5

7 Select the erasure width with the [◀] or [▶] key.

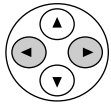

If you select 0 mm (0"), the printed result is the same as when "OFF" is selected.

8 Press the [OK] key.



You will return to the base screen.

9 Select other copy settings as needed and press the [START] key (Ⓢ).

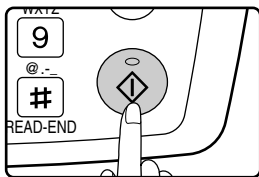

To cancel an edge erase setting, return to the edge erase settings screen and select "OFF".

CARD SHOT

When copying a card, this function allows you to print the front and back sides of the card next to each other on a single sheet of paper.

This function creates 2 in 1 images of the front and back side of the card and centres them on the paper.

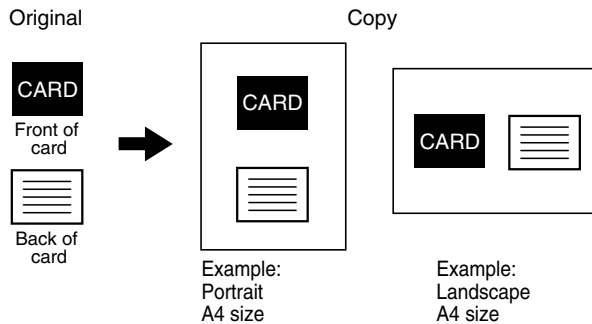

- Paper cannot be fed from the bypass tray.
- The card shot function cannot be used in combination with margin shift, edge erase, dual page copy, 2 in 1 / 4 in 1 copy, and XY zoom copy.
- When card shot is used, the rotation copy function does not operate.

1 Place the original on the document glass.

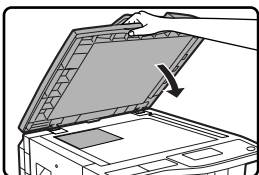

2 Press the [SPECIAL FUNCTION] key.

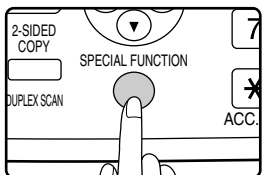

The special function screen will appear.

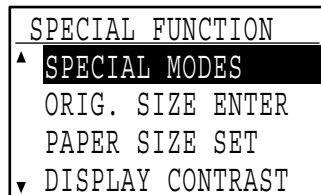

3 Press the [OK] key.

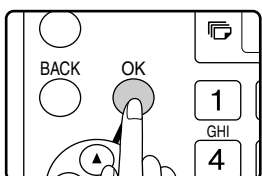

The special modes screen will appear.

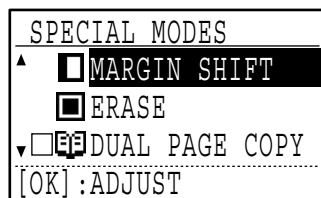

4 Select "CARD SHOT" with the [▼] or [▲] key.

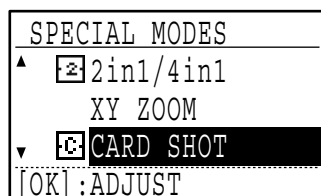
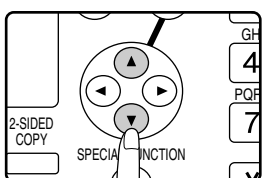

5 Press the [OK] key.

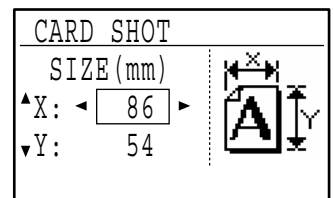

The card shot screen appears.



The default values for the length and width that initially appear when this screen is displayed can be set "CARD SHOT DEFAULT" (page 86) in the key operator programs.

6 Select "X" (width) with the [▼] or [▲] key and enter the width with the [◀] or [▶] key, and then do the same for the length (Y).

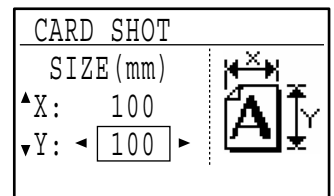
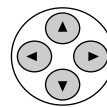

Any number from 25 mm to 210 mm (1" to 8-1/2") can be entered for the width, and any number from 25 mm to 210 mm (1" to 8-1/2") can be entered for the length.

7 Press the [OK] key.



You will return to the base screen.

8 Press the [START] key (⏏).

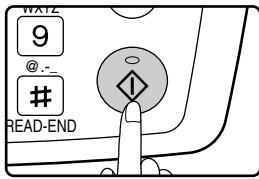

The front side of the card is scanned.

9 Turn the original over on the document glass.

10 Press the [START] key (⏏).



Copying will start after both sides of the original have been scanned.

6

APPENDIX

SPECIFICATIONS

Name	Digital Multifunctional System	
	AR-M161/AR-M162/AR-M165	AR-M206/AR-M207
Type	Desktop	
Photoconductive type	OPC drum	
Document glass type	Fixed	
Copy system	Laser electrostatic method	
Originals	Sheets, bound documents, max. original size A3 (11" x 17")	
Copy sizes	Max. A3 (11" x 17"), min. A5 (5-1/2" x 8-1/2") (A5 (5-1/2" x 8-1/2") can only be fed from tray 1 and the bypass tray)	
Image loss:	Max. 4 mm (5/32") at top edge and bottom edge, combined maximum of approximately 6 mm (11/64")	
Copying speed	9 copies/min. A3 (11" x 17") 10 copies/min. B4 (8-1/2" x 14") 11 copies/min. 8-1/2" x 13" 12 copies/min. A4R (8-1/2" x 11"R) 14 copies/min. B5R 16 copies/min. A4, B5, A5 (8-1/2" x 11", 5-1/2" x 8-1/2")	10 copies/min. 11" x 17" 11 copies/min. A3 12 copies/min. B4 (8-1/2" x 14", 8-1/2" x 13") 14 copies/min. A4R 15 copies/min. 8-1/2" x 11"R 16 copies/min. B5R 20 copies/min. A4, B5, A5 (8-1/2" x 11", 5-1/2" x 8-1/2")
Continuous copying	1-999 copies (decrement type) (can be changed to 1- 99 in the key operator programs)	
First-copy time*1, *2	Approx. 7.2 s	
Warm-up time*2	Approx. 45 sec.	
Copy ratios	Variable: 25% to 400%, in 1% increments (total 376 steps) (50% to 200% when the SPF is used) Fixed preset: 25%, 50%, 70%, 81%, 86%, 100%, 115%, 122%, 141%, 200%, 400% (25%, 50%, 64%, 77%, 95%, 100%, 121%, 129%, 141%, 200%, 400%) (25% and 400% only when the SPF is used)	
Paper feeding	One automatic feeding paper tray (250 sheets) + bypass tray (100 sheets)	Two automatic feeding paper trays (250 sheets each) + bypass tray (100 sheets)
Fusing system	Heat rollers	
Developer system	Dry development	
Resolution	Scanning: 600 x 300 dpi, output: 600 x 600 dpi (AUTO/TEXT mode) Scanning: 600 x 600 dpi, output: 600 x 600 dpi (PHOTO mode)	
Gradation	Scanning: 256 halftones, printing: 2 halftones	
Power supply	Local voltage $\pm 10\%$ (For this machine's power supply requirements, see the name plate located on the back of the machine.)	
Power consumption	Max. 1.2 kW	

*1 Measured when copying is started after warm-up following power on, using the document glass. (Exposure set to "AUTO". "RESOLUTION IN AUTO/TEXT MODE" set to 300 dpi and "WAITING COPY LAMP SETTING" set to "ON" in the key operator programs. Paper fed from tray 1 on machine, A4 (8-1/2" x 11") original and paper oriented horizontally, no reduction or enlargement.)

*2 May vary depending on machine operating conditions and ambient conditions such as power voltage and humidity.

Overall dimensions	590 mm (W) x 595 mm (D) (23-15/64" (W) x 23-7/16" (D)) (with bypass tray folded)	
Weight (Not including toner cartridge)	AR-M161: Approx. 29.7kg (65.5 lbs.) AR-M162/AR-M165: Approx. 30.0kg (66.2 lbs.) AR-M206: Approx. 33.8kg (74.6 lbs.) AR-M207: Approx. 34.2kg (75.3 lbs.)	
Dimensions	590 mm (W) x 595 mm (D) x 469 mm (H) (23-15/64" (W) x 23-7/16" (D) x 18-15/32" (H))	590 mm (W) x 595 mm (D) x 520 mm (H) (23-15/64" (W) x 23-7/16" (D) x 20-31/64" (H))
Operating conditions	Temperature: 15°C to 30°C (59°F to 86°F), Humidity: 20% to 85%	
Noise level	Sound Power Level LwA (1B=10dB) Copying: 6.3[B] or less Standby: 4.0[B] or less Noise emission measurement in accordance with ISO 7779.	
Emission concentration (measured according to RAL-UZ62: Edition Jan. 2002)	Ozone: 0.02 mg/m ³ or less Dust: 0.075 mg/m ³ or less Styrene: 0.07 mg/m ³ or less	

Output tray specifications

Output method	Face-down output
Output tray capacity (80 g/m ² (20 lbs.))	250 sheets*

* When the job separator tray kit is installed, 150 sheets in centre tray, 100 sheets in top tray.
The maximum number of pages that can be held varies depending on ambient conditions in the installation location, the type of paper, and the storage conditions of the paper.

Printer function / scanner function / fax function specifications

See the "Operation manual (for printer and scanner)" and the "Operation manual (for facsimile)".

Some discrepancies may exist in the illustrations and content due to improvements to the machine.

PURPOSE OF THE KEY OPERATOR PROGRAMS

The key operator programs are used by the administrator of the machine to enable or disable functions to suit the needs of your workplace.

This manual explains only the key operator programs that are common to all the functions of the machine, (copy, fax, printer and network scanner functions), as well as key operator programs that are specifically for the copy function. For programs that are specifically for the fax function, printer function, or network scanner function, see the following manuals:

- Fax function: Operation manual (for facsimile), Chapter 8, "KEY OPERATOR PROGRAMS"
- Printer function / scanner function: Operation manual (for printer and scanner), Chapter 4, "KEY OPERATOR PROGRAMS"
- Network printer function: Operation manual (for network printer), Chapter 5 "KEY OPERATOR PROGRAMS"
- Network scanner function: Operation manual (for network scanner), Chapter 3 "KEY OPERATOR PROGRAMS"

To use the key operator programs, the key operator code must be entered.

PROGRAMS RELATED TO ALL FUNCTIONS OF THE MACHINE (COPY, FAX, PRINTER, AND NETWORK SCANNER FUNCTIONS)

These programs are used to enable auditing mode, adjust power consumption, and manage peripheral devices. Auditing mode can be enabled separately for the copy, network printer, fax, and network scanner functions. When auditing mode is enabled for a function, a valid account number must be entered in order to use the function. (If a valid account number is not entered, the function cannot be used.)

When auditing mode is enabled for the printer function, an account number must be entered at the user's computer when the print command is selected. (Depending on the key operator program settings, a job may be printed even if an incorrect account number is entered, and thus care must be taken when managing printer page counts.) If "CANCEL JOBS OF INVALID ACCOUNTS" is enabled in the key operator programs, printing will be prohibited if an invalid account number is entered.)

PROGRAMS FOR COPY MODE

These programs are used to change the factory default copy settings to settings that better suit the needs of your workplace.

When auditing mode is enabled for the copy function,

- A valid account number must be entered to make copies.
(Copying is not possible unless a valid account number is entered.)
- A count is kept of the number of copies made by each account. This allows you to monitor copier usage by account. (The counts can be totaled.)
 - * The account number is a five-digit number.
- A limit can be set for the number of copies that can be made by each account.

PROGRAMMING A KEY OPERATOR CODE

The key operator code is a 5-digit number that must be entered in order to access the key operator programs. The key operator (administrator of the machine) should change the default key operator code that was set at the factory to a new 5-digit number. Be sure to remember the new key operator code, as it must be entered each time the key operator programs are subsequently used. (Only one key operator code can be programmed.)

See page 103 for the factory default key operator code.

To change the key operator code, see "PROGRAMMING A KEY OPERATOR CODE" (page 76).

PROGRAMMING A KEY OPERATOR CODE

1 Press the [SPECIAL FUNCTION] key.

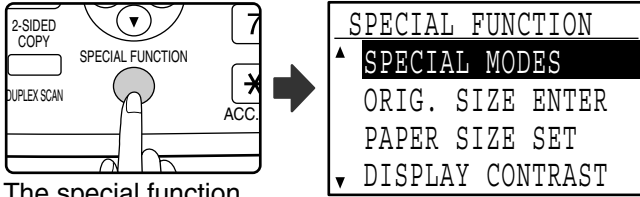

The special function screen will appear.

2 Select "KEY OPERATOR PRG." with the [▼] or [▲] key.

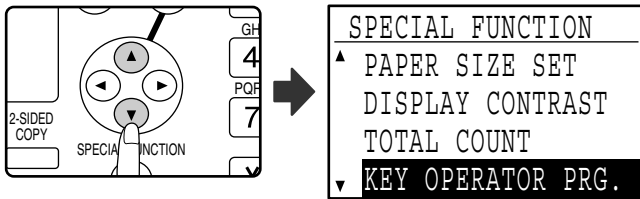

3 Press the [OK] key.

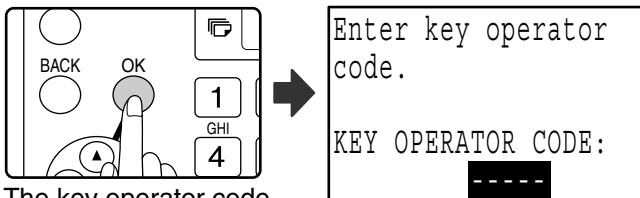

The key operator code entry screen appears.

4 Use the numeric keys to enter the five-digit key operator code.

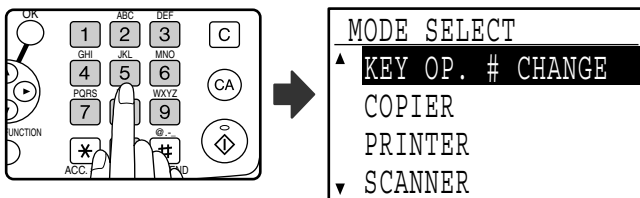

- If this is the first time you are programming the key operator code, enter the factory default code. (Page 103)
- "X" appears for each digit that you enter.
- The special modes screen will appear with "KEY OP. # CHANGE" selected.

5 Press the [OK] key.

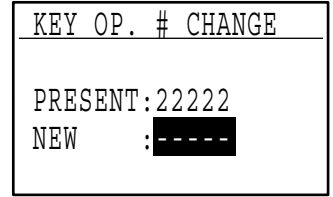

The key operator code change screen appears.

6 Enter the new 5-digit key operator code with the numeric keys.

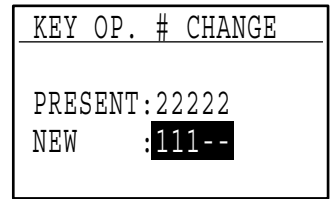

Any 5 digits can be used for the key operator code.

7 Press the [OK] key.



- The previously programmed key operation code is replaced by the new key operator code.
- Press the [CA] key to return to the base screen.

KEY OPERATOR PROGRAM LIST

A list of basic programs used for the machine and a list of programs used for the copy function are shown below.

Programs for general use of the machine

Program name	Page
KEY OPERATOR CODE CHANGE	
KEY OPERATOR CODE CHANGE	76
ACCOUNT CONTROL	
AUDITING MODE	79
TOTAL/ACCOUNT	79
RESET ACCOUNT	79
ACC. # CONTROL	80
ACCOUNT LIMIT	81
ACC. # SECURITY	81
CANCEL JOBS OF INVALID ACCOUNTS	81
DEVICE CONTROL	
WAITING COPY LAMP SETTING	81
OFFSET FUNCTION	82
MEM. FOR PRINTER*	82
USB2.0 MODE*	82
RETURN FROM COPY MODE TIMING	83
OPERATION SETTING	
AUTO CLEAR	83
DISABLE DISPLAY TIMEOUT	83
LANGUAGE SETTING	83
MESSAGE TIME	83
KEY TOUCH SOUND	84
KEYS TOUCH SOUND AT INITIAL POINT	84
KEY PRESS TIME	84
DISABLE AUTO KEY REPEAT	84
DISABLE PAPER SIZE SET	84
ENERGY SAVE	
AUTO POWER SHUT-OFF	85
AUTO POWER SHUT-OFF TIMER	85
PREHEAT MODE	85
TONER SAVE MODE	85

Programs for Copy Mode

Program name	Page
COPY SETTINGS	
EXPOSURE ADJUST	86
MARGIN DEFAULT*	86
ERASE ADJUST*	86
CARD SHOT DEFAULT*	86
DEFAULT TRAY SET	86
DEFAULT EXPOSURE	87
STREAM FEEDING	87
ROTATION COPY*	87
SORT AUTO SELECT*	87
RESOLUTION IN AUTO/TEXT MODE	88
PHOTO MODE DEFAULT	88
LIMIT OF COPIES	88
DISABLE AUTO PAPER SELECTION	88
DISABLE 2-SIDED COPY	88

* The dual function board must be installed.

USING THE KEY OPERATOR PROGRAMS

1 Press the [SPECIAL FUNCTION] key.

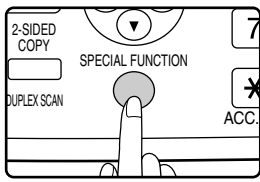

The special function screen will appear.

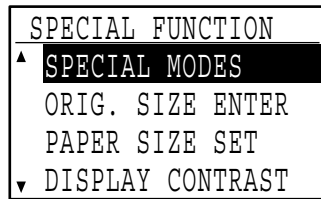

2 Select "KEY OPERATOR PRG." with the [▼] or [▲] key.

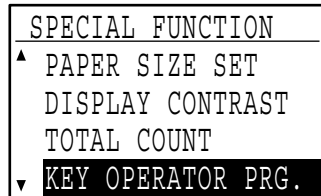
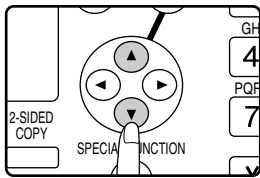

3 Press the [OK] key.

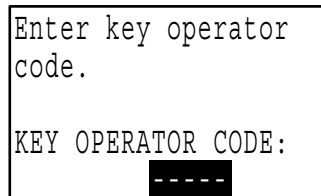
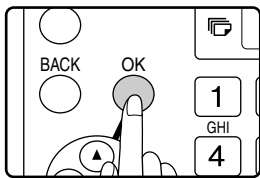

The key operator code entry screen appears.

4 Enter the key operator code with the numeric keys.

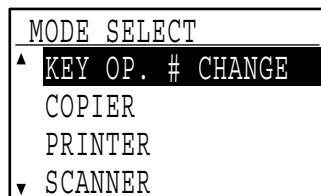
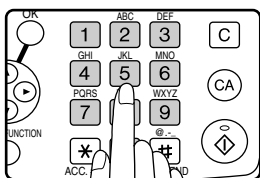

- " * " appears for each digit that you enter.
- The mode selection screen appears.

5 Select the desired mode with the [▼] or [▲] key.

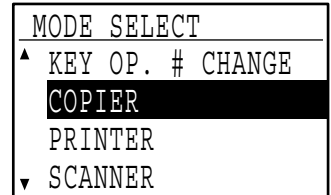
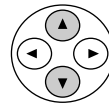

Example: The screen when "COPIER" is selected.

6 Press the [OK] key.

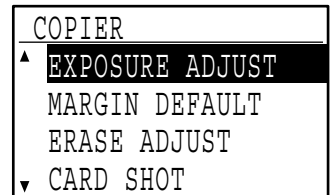

The settings of the selected mode appear.

Several programs will have checkboxes in front of them. To enable a function (make a checkmark appear), press the [OK] key. To disable the function, press the [OK] once again to remove the checkmark. To configure a program that has a checkbox, go to step 9.

7 Select the desired program with the [▼] or [▲] key.

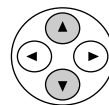

8 Press the [OK] key and follow the instructions in the program screen.



9 To use another program for the same mode, select the desired program with the [▼] or [▲] key.

To use a program for a different mode, press the [BACK] key and select the desired mode. To exit the key operator programs, press the [CA] key.

ACCOUNT CONTROL

These programs are used to control use of the machine by account. To access one of these programs, select "ACCOUNT CONTROL" in the mode selection screen, select the desired program in the account control screen, and press the [OK] key.

AUDITING MODE

This program is used to enable auditing mode for copy, print, and scan mode. To enable auditing mode for fax mode, see the "Operation manual (for facsimile)".

When auditing mode is enabled, a count is kept of the number of pages output by each account (up to 50 accounts can be established), and the counts can be displayed and totaled as necessary. To use the machine, the 5-digit account number programmed for the user's account must be entered.

To enable auditing mode for the printer and scanner functions, the optional network expansion kit is required. If the network expansion kit is not installed, auditing mode cannot be used for printing and scanning that takes place via the parallel port or USB port. Auditing mode for the printer function can only be used for PCL and PS printers. Auditing mode for the scanner function can only be used for network scanning.

Auditing mode is initially disabled for all modes (factory default setting).

Select "AUDITING MODE" and press the [OK] key. The following screen will appear.

AUDITING MODE	
▲	<input checked="" type="checkbox"/> COPIER
	<input checked="" type="checkbox"/> PRINTER
▼	<input checked="" type="checkbox"/> SCANNER

- 1 Select the desired mode with the [▼] or [▲] key.
- 2 To enable auditing mode for the selected mode, press the [OK] key so that a checkmark appears in the checkbox.

Auditing mode is enabled.

To disable auditing mode for the selected mode, press the [OK] key to remove the checkmark from the checkbox.

Auditing mode is disabled.



After enabling "AUDITING MODE", program account numbers as explained in "ACC. # CONTROL" on page 80.

TOTAL/ACCOUNT

This program is used to display the page counts of each account in copy, print, and scan modes, and the usage limits for copy and print modes. Misfed pages are not included in the page counts.

For the network scanner function, the number of transmitted pages is displayed.

When the network expansion kit is installed, pages that were printed or transmitted using the parallel port or USB port in print mode or scan mode are included in the "OTHERS" (account number) counts.

Select "TOTAL/ACCOUNT" and press the [OK] key. The following screen will appear.

TOTAL/ACCOUNT	
▲	ACCOUNT #: 18114
	COPIES 000,222
▼	COPY LIMIT 02,000
[▶]:NEXT	

Switch to the page counts in other modes for the same account, as well as the page limits, with the [◀] or [▶] key.

To change to a different account number, press the [▼] or [▲] key.

RESET ACCOUNT

This program is used to reset the copy, print, and scan page counts of an individual account, or all accounts, to zero.

Select "RESET ACCOUNT" and press the [OK] key. The following screen will appear.

RESET ACCOUNT	
▲	RESET 1 ACC.
▼	RESET ALL ACC.

Resetting the page counts of all accounts

- 1 Select "RESET ALL ACC." with the [▼] or [▲] key and then press the [OK] key.
- 2 Select "YES" with the [▼] or [▲] key and then press the [OK] key.

Resetting a single account

- 1** Select "RESET 1 ACC." with the [▼] or [▲] key and then press the [OK] key.
- 2** Select the desired account with the [▼] or [▲] key.
If "---,---" appears for a page limit, a limit has not been set.
- 3** Select the desired mode with the [◀] or [▶] key and then press the [OK] key.
- 4** Press the [▼] or [▲] key to select "YES" and then press the [OK] key.
- 5** If you wish to reset the page counts of another account, repeat steps 2 to 4.
- 6** To exit, press the [BACK] key repeatedly.

ACC. # CONTROL

This program is used to program, delete, and change account numbers.

Select "ACC. # CONTROL" and press the [OK] key. The following screen will appear.

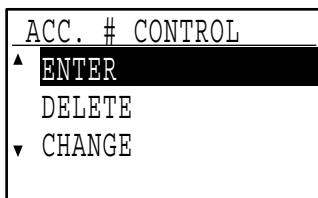

Programming an account number

- 1** Select "ENTER" with the [▼] or [▲] key and then press the [OK] key.
If 50 accounts have already been programmed, a warning message will appear. Delete any unneeded accounts and then program the new account.
- 2** Use the numeric keys to enter a five-digit account number (00000 to 99999).
The key operator code cannot be used as an account number.
- 3** Press the [OK] key.
If you enter an account number that has already been programmed in step 2, a warning message will appear and you will return to step 2. Enter a different number.
- 4** If you wish to program another account number, repeat steps 2 and 3.
- 5** To exit, press the [BACK] key repeatedly.

Deleting an account number

- 1** Select "DELETE" with the [▼] or [▲] key and then press the [OK] key.
- 2** If you wish to delete all account numbers, select "DELETE ALL ACC." and press the [OK] key.
When the message "DELETE?" appears, select "YES" with the [▼] or [▲] key to delete all accounts and press the [OK] key. If you do not wish to delete all account numbers, select "NO" and press the [OK] key.
- 3** If you wish to delete an each account number, select "DELETE 1 ACC." and press the [OK] key.
- 4** Enter the account number that you wish to delete with the numeric keys and then press the [OK] key.
- 5** Select "YES" with the [▼] or [▲] key and then press the [OK] key.
If you enter a number that has not been programmed in step 4 and then press the [OK] key, you will return to the number entry screen of step 4.
- 6** If you wish to delete another account number, repeat steps 4 and 5.
- 7** To exit, press the [BACK] key repeatedly.

Changing an account number

- 1** Select "CHANGE" with the [▼] or [▲] key and then press the [OK] key.
- 2** Enter the account number that you wish to change in "PRESENT #".
- 3** Enter the new account number in "NEW #".
- 4** Press the [OK] key.
If you enter an account number that has already been programmed in step 3, a warning message will appear and you will return to step 3. Enter a different number.
- 5** If you wish to change another account number, repeat steps 2 to 4.
- 6** To exit, press the [BACK] key repeatedly.



- When entering an account number, the [OK] key will not be accepted unless 5 digits have been entered.
- If you press the [C] key while entering an account number, the account number display will change to "-----".

ACCOUNT LIMIT

This program is used to set limits for the number of pages that can be printed by each account in print mode and copy mode.

Select "ACCOUNT LIMIT" and press the [OK] key. The following screen appears.

ACCOUNT LIMIT
▲ SINGLE ACC. LIMIT
▼ ALL ACC. LIMIT

Limiting the number of pages used by an account

- 1 Select "SINGLE ACC. LIMIT" with the [▼] or [▲] key and then press the [OK] key.
- 2 Select "COPIER" or "PRINTER" mode with the [▼] or [▲] key.
- 3 Press the [OK] key.
- 4 Enter the desired account number with the numeric keys.
- 5 Enter a page usage limit with the numeric keys (max. 50000).
 - "0" cannot be specified.
 - If you wish to cancel the limit, press the [C] key and go to step 6.
- 6 Press the [OK] key.
- 7 If you wish to set a limit for another account number, repeat steps 4 to 6.

If you press the [BACK] key, you will return to the screen of step 2. If you wish to set a limit for the other mode (copy or printer), select the mode in step 2 and repeat steps 3 to 6. To exit, press the [BACK] key repeatedly.

Setting a limit for all accounts

- 1 Select "ALL ACC. LIMIT" with the [▼] or [▲] key and then press the [OK] key.
- 2 Select "COPIER" or "PRINTER" mode with the [▼] or [▲] key.
- 3 Enter the page usage limit for all accounts with the numeric keys (max. 50000).

If you wish to cancel the limit, press the [C] key and go to step 4.

4 Press the [OK] key.

You will return to the screen of step 2. If you wish to set a limit for the other mode (copy or printer), select the mode in step 2 and repeat steps 3 to 4. To exit, press the [BACK] key repeatedly.

ACC. # SECURITY

When this program is enabled, the machine will not allow operation for one minute if an incorrect account number is entered three times in a row. During this time, "Please see your key operator for assistance." will appear in the display.

To enable this program, select "ACC. # SECURITY" and then press the [OK] key so that a checkmark appears in the checkbox.

To disable this program, select "ACC. # SECURITY" and then press the [OK] key so that a checkmark does not appear in the checkbox.

CANCEL JOBS OF INVALID ACCOUNTS

When enabled, this program cancels a print job if no account number is entered or an invalid account number is entered. This program is only effective when "AUDITING MODE" has been enabled for print mode. The function is initially disabled (factory default setting).

To prohibit printing when a valid account number is not entered, select "CANCEL JOBS OF INVALID ACCOUNTS" and then press the [OK] key so that a checkmark appears in the checkbox.

To allow printing when a valid account number is not entered, select "CANCEL JOBS OF INVALID ACCOUNTS" and then press the [OK] key to remove the checkmark from the checkbox.



Pages printed by invalid account numbers are added to the page count of "OTHERS" (account number).

7

DEVICE CONTROL

These programs are used to configure settings for hardware functions of the machine. To access one of these programs, select "DEVICE CONTROL" in the mode selection screen, select the desired program in the device control screen, and press the [OK] key.

WAITING COPY LAMP SETTING

This program is used to select whether the copy lamp (light source) is on or off when the machine is in standby mode. If the copy lamp (light source) is set to turn off in standby mode, power will be conserved, however, the first copy time will be longer than if the lamp is on. The factory default setting is "ON".

Select "WAITING COPY LAMP SETTING" and press the [OK] key. The following screen will appear.

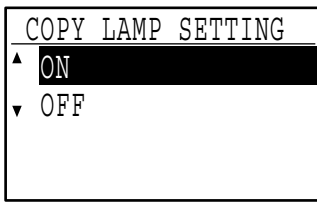

- 1 Select "ON" or "OFF" with the [▼] or [▲] key.
- 2 Press the [OK] key.

OFFSET FUNCTION

When the offset function is enabled, sets of output will be offset from each other for easy separation when copying is performed in sort mode or non-sort mode. The offset function can be enabled separately for the top tray (this only appears if the job separator tray kit has been installed) and centre tray. The function is initially enabled (factory default setting) for both the top tray and the centre tray.

Select "OFFSET FUNCTION" and press the [OK] key. The following screen will appear.



- 1 Select "UPPER TRAY" or "CENTRE TRAY" with the [▼] or [▲] key.
- 2 Press the [OK] key.
 - The setting is enabled and a checkmark appears in the checkbox.
 - If this procedure is performed when the setting is already enabled, the checkmark is cleared and the setting is disabled.

MEM. FOR PRINTER

(When the dual function board is installed)

The machine is equipped with memory that stores scanned original image data. Part of this memory is also used to store print data. This program is used to set the percentage of memory that is allocated to the print function. The memory allocation can be set from 30% to 70% in increments of 10%. The factory default setting is "50%"

Select "MEM. FOR PRINTER" and press the [OK] key. The following screen will appear.

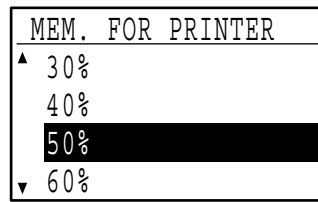

- 1 Select the desired percentage with the [▼] or [▲] key.
- 2 Press the [OK] key.



The memory for storing original image data and print data is 16 MB. An optional memory module can be installed to expand memory to 272 MB (the module adds 256 MB).

USB2.0 MODE

(When the dual function board is installed)

This sets the data transfer speed of the USB 2.0 port (USB-2). When this program is set to "HI-SPEED", scanning data is primarily transferred at a higher speed.

The factory default setting is "FULL-SPEED". If you wish to use USB 2.0 (Hi-Speed mode), be sure to read "System requirements for USB 2.0 (Hi-Speed mode)" (page 83) to verify that your system and the machine settings are configured appropriately.

Select "USB2.0 MODE" and press the [OK] key. The following screen will appear.

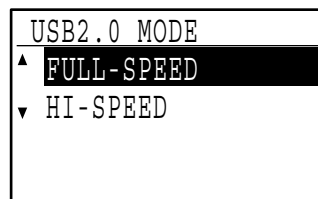

- 1 Select the transfer speed with the [▼] or [▲] key.
- 2 Press the [OK] key.

System requirements for USB 2.0 (Hi-Speed mode)

The USB port (USB-2) on the machine supports USB 2.0 Hi-Speed mode.

The following system is required to use USB 2.0 (Hi-Speed mode):

The computer is running Windows XP/2000 and the Microsoft USB 2.0 driver is pre-installed, or the USB 2.0 driver for Windows XP/2000 that Microsoft provides through Windows Update is installed.

* Even when the Microsoft USB 2.0 driver is installed, some USB 2.0 expansion cards are not capable of attaining the speed stipulated by the Hi-Speed standard. This problem can often be fixed by installing a more recent driver for the card. To obtain the most recent driver for your card, contact the card's manufacturer.

RETURN FROM COPY MODE TIMING

When there are print jobs or fax print jobs waiting to be printed after copy job is finished, this program is used to set a brief wait time until printing of those jobs begins. Setting a brief wait time allows another copy job to be performed following the previous copy job. Time selections are "0 sec.", "10 sec.", "30 sec.", and "60 sec."

The factory default setting is 30 seconds.

Select "RETURN FROM COPY MODE TIMING" and press the [OK] key. The following screen will appear.

1 Select the desired time with the [◀] or [▶] key.

2 Press the [OK] key.

OPERATION SETTING

These programs are used to configure various settings related to the operation panel. To access one of these programs, select "OPERATION SETTING" in the mode selection screen, select the desired program in the operation setting screen, and press the [OK] key.

AUTO CLEAR

This function returns the copy settings to the default settings if the operation panel is not used for the duration of time set with this program following the end of a copy job. Time selections are "0 sec.", "10 sec.", "20 sec.", "60 sec.", "90 sec." and "120 sec."

The factory default setting is 60 seconds.

Select "AUTO CLEAR" and press the [OK] key. The following screen will appear.

1 Select the desired time with the [◀] or [▶] key.

If you do not want auto clear to operate, select "0".

2 Press the [OK] key.

DISABLE DISPLAY TIMEOUT

This program is used to select whether or not the display will automatically return to the base screen if no keys are pressed on the operation panel for one minute in scan or fax mode.

The factory default setting is automatic return to the base screen.

To disable automatic return to the base screen, select "DISABLE DISPLAY TIMEOUT", and press the [OK] key so that a checkmark appears in the checkbox.

To re-enable automatic return to the base screen, select "DISABLE DISPLAY TIMEOUT" once again and press the [OK] key to clear the checkmark from the checkbox.

LANGUAGE SETTING

This program is used to select the display language. Select "LANGUAGE SETTING", press the [OK] key, and follow the steps below.

1 Select the display language with the [▼] or [▲] key.

2 Press the [OK] key.

MESSAGE TIME

This program is used to set the length of time that messages appear in the display (this applies to messages that appear for a certain length of time and then automatically disappear.) Select from "SHORT (3 sec.)", "NORMAL (6 sec.)", or "LONG (9 sec.)". The factory default setting is "NORMAL (6 sec.)".

Select "MESSAGE TIME" and press the [OK] key. The following screen will appear.

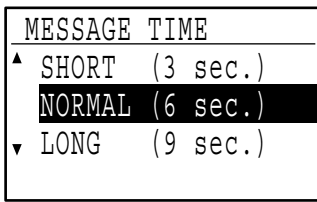

- 1** Select the desired display time with the [▼] or [▲] key.
- 2** Press the [OK] key.

KEY TOUCH SOUND

This program is used to set the volume of the key touch sound that is heard each time a key is pressed. The initial factory setting is "LOW".

Select "KEY TOUCH SOUND" and press the [OK] key. The following screen will appear.

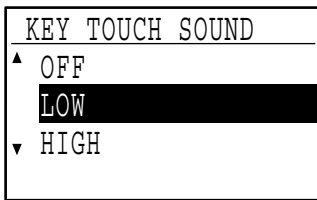

- 1** Select the desired volume with the [▼] or [▲] key.
To turn the key touch sound off, select "OFF".
- 2** Press the [OK] key.

KEYS TOUCH SOUND AT INITIAL POINT

This program is used to select whether or not a beep will sound at preset base settings as you press a key to select a setting. The factory default setting is no beep.

If you would like a beep to sound, select "KEYS TOUCH SOUND AT INITIAL POINT" and press the [OK] key so that a checkmark appears in the checkbox.

If you would not like a beep to sound, select "KEYS TOUCH SOUND AT INITIAL POINT" once again and press the [OK] key so that the checkmark is cleared from the checkbox.

KEY PRESS TIME

This program is used to set the duration of time that a key must be pressed to take effect. A longer setting can be selected to prevent keys pressed accidentally from taking effect. Keep in mind, however, that when a longer setting is selected more care is required when pressing keys to ensure that the key input is registered. The initial factory setting is "MINIMUM".

Select "KEY PRESS TIME" and press the [OK] key. The following screen appears.

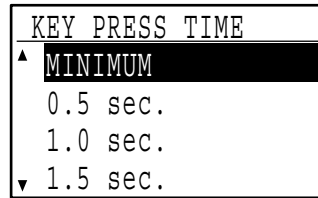

- 1** Select the desired time with the [▼] or [▲] key.
- 2** Press the [OK] key.

DISABLE AUTO KEY REPEAT

This program is used to stop a setting from changing continuously when the [▼] or [▲] key is held down, such as when setting the zoom ratio or the original size (auto key repeat will not operate). When this program is enabled, a key must be pressed repeatedly instead of holding it down. Auto key repeat is initially set to operate (factory default setting).

To disable auto key repeat, select "DISABLE AUTO KEY REPEAT" and press the [OK] key so that a checkmark appears in the checkbox.

To re-enable auto key repeat, select "DISABLE AUTO KEY REPEAT" once again and press the [OK] key so that the checkmark is cleared from the checkbox.

DISABLE PAPER SIZE SET

This program is used to disable "PAPER SIZE SET" in the special functions menu. When disabled, "PAPER SIZE SET" cannot be used when the [SPECIAL FUNCTIONS] key is pressed, which prevents users other than the administrator from easily changing the paper size setting. "DISABLE PAPER SIZE SET" is initially disabled (factory default setting).

To enable the setting, select "DISABLE PAPER SIZE SET" and press the [OK] key so that a checkmark appears in the checkbox.

To disable the setting, select "DISABLE PAPER SIZE SET" once again and press the [OK] key so that the checkmark is cleared from the checkbox.

ENERGY SAVE

These programs are used to configure energy saving settings. To access one of these programs, select "ENERGY SAVE" in the mode selection screen, and select the desired program in the energy save screen, and then press the [OK] key.

AUTO POWER SHUT-OFF

This program is used to enable auto power shut-off mode, which automatically turns off the power to the fusing unit if the operation panel is not used for a certain duration of time.

Enabling auto power shut-off mode helps conserve energy, preserve natural resources, and reduce environmental pollution.

The function is initially enabled.



Rather than disabling the auto power shut-off feature, it is recommended that you first try lengthening the time set in "AUTO POWER SHUT-OFF TIMER" (see below). In most cases a suitable timer setting will allow work to proceed with minimal delay and still enable you to enjoy the benefits of power conservation.

To enable auto power shut-off mode, select "AUTO POWER SHUT-OFF", and press the [OK] key so that a checkmark appears in the checkbox.

To disable auto power shut-off mode, select "AUTO POWER SHUT-OFF" once again and press the [OK] key so that the checkmark is cleared from the checkbox.

AUTO POWER SHUT-OFF TIMER

This program is used to set the duration of time until auto power shut-off mode activates when the operation panel is not used. Using this function helps conserve energy, preserve natural resources, and reduce environmental pollution.

"5 min.", "30 min.", "60 min.", "120 min." or "240 min." can be selected for the duration of time. Select a setting that suits your work conditions.

The factory default setting is "5 min."

Select "AUTO POWER SHUT-OFF TIMER" and press the [OK] key. The following screen will appear.

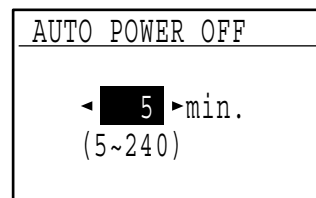

1 Select the desired time with the [◀] or [▶] key.

2 Press the [OK] key.

PREHEAT MODE

This program is used to set the duration of time until preheat mode, which automatically lowers the fusing unit temperature, activates when the operation panel is not used. Using this function helps conserve energy, preserve natural resources, and reduce environmental pollution. "1 min.", "5 min.", "30 min.", "60 min.", "120 min.", or "240 min." can be selected for the duration of time. Select a setting that suits your work conditions. The factory default setting is "1 min."

Select "PREHEAT MODE" and press the [OK] key. The following screen will appear.

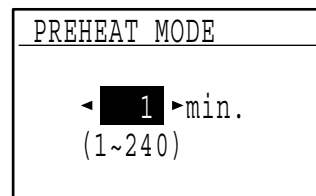

1 Select the desired time with the [◀] or [▶] key.

2 Press the [OK] key.

TONER SAVE MODE

The toner save mode will reduce toner consumption by approximately 10% in the automatic and text, exposure modes. Copies will be lighter but still adequate for general use. Selection of this mode has no effect on the photo mode.

The function is initially disabled (factory default setting).

To turn on the toner save mode, highlight "TONER SAVE MODE" and press the [OK] key to display a check mark in the check box.

To turn off the toner save mode, select this program and press the [OK] key again to clear the check mark in the check box.

COPY SETTINGS

These programs are used to enable various copy functions. To access one of these programs, select "COPIER" in the mode selection screen, select the desired program in the copy settings screen, and press the [OK] key.

EXPOSURE ADJUST

This program is used to adjust the exposure level when "AUTO" is used for the exposure mode. The auto exposure level can be set separately for the document glass and the SPF. One of five levels can be selected, with the left end of the scale the lightest level and the right end of the scale the darkest level. The factory default setting is the middle level.

Select "EXPOSURE ADJUST" and press the [OK] key. The following screen will appear.

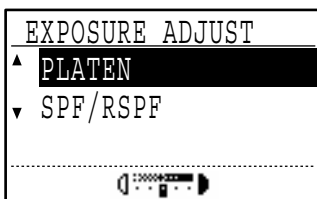

- 1 Select "PLATEN" or "SPF/RSPF" with the [▼] or [▲] key.
- 2 Press the [◀] or [▶] key to adjust the exposure.
- 3 Repeat steps 1 and 2 to adjust the other exposure.
- 4 Press the [OK] key.

MARGIN DEFAULT

(When the dual function board is installed)

This is used to set the default margin width. The factory default setting is "10 mm (1/2 inch)".

Select "MARGIN DEFAULT" and press the [OK] key. The following screen will appear.

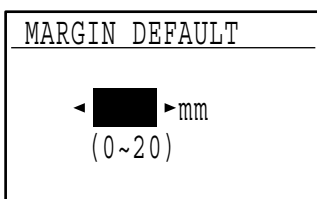

- 1 Adjust the default margin width with the [◀] or [▶] key.
The width can be set from 0 to 20 mm in increments of 5 mm (0" to 1" in increments of 1/4").
- 2 Press the [OK] key.

ERASE ADJUST

(When the dual function board is installed)

This is used to set the default erasure width. The factory default setting is "10 mm (1/2 inch)".

Select "ERASE ADJUST" and press the [OK] key. The following screen will appear.

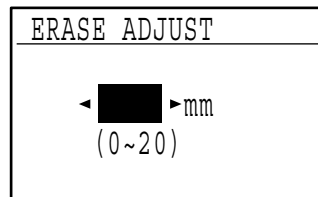

- 1 Adjust the edge erase and centre erase width with the [◀] or [▶] key.
The edge erase width and the centre erase width share the same default value, which can be set from 0 to 20 mm in increments of 5 mm (0" to 1" in increments of 1/4").
- 2 Press the [OK] key.

CARD SHOT DEFAULT

(When the dual function board is installed)

This program is used to set the default dimensions that appear when the card shot size entry screen is displayed. The factory default settings are 86 mm (3-3/8") for the width (X) and 54 mm (2-1/8") for the length (Y).

Select "CARD SHOT DEFAULT" and press the [OK] key. The following screen will appear.

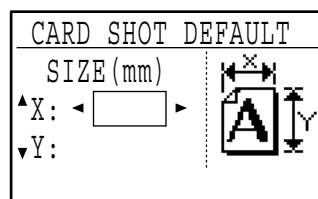

- 1 Select X or Y with the [▼] or [▲] key and adjust the corresponding default value with the [◀] or [▶] key.
- 2 Press the [OK] key.

DEFAULT TRAY SET

This program is used to set which tray is selected by default. Trays that appear for selection will vary depending on the optional trays that have been installed. The factory default setting is "TRAY 1".

Select "DEFAULT TRAY SET" and press the [OK] key. The following screen will appear.

DEFAULT TRAY SET	
▲	TRAY 1
	TRAY 2
	TRAY 3
▼	TRAY 4

- 1 Select the tray with the [▼] or [▲] key.
- 2 Press the [OK] key.

DEFAULT EXPOSURE

This program is used to select the exposure mode/level that is initially selected when the [EXPOSURE] key is pressed. The factory default setting is "AUTO".

Select "DEFAULT EXPOSURE" and press the [OK] key. The following screen will appear.

DEFAULT EXPOSURE	
▲	<input checked="" type="checkbox"/> AUTO
	<input type="checkbox"/> TEXT
▼	<input type="checkbox"/> PHOTO

- 1 Select the exposure mode with the [▼] or [▲] key.
- 2 If you selected "TEXT" or "PHOTO", set the exposure level with the [◀] or [▶] key.
- 3 Press the [OK] key.

STREAM FEEDING

When stream feeding mode is enabled, additional originals which are placed in the SPF within 5 seconds after the previous original was fed will be copied automatically. (If more than 5 seconds elapse, the [START] key (Ⓢ) must be pressed again.)

This function can be used when scanning originals in copy and scan modes.

The function is initially disabled (factory default setting).

To enable stream feeding, select "STREAM FEEDING" and press the [OK] key so that a checkmark appears in the checkbox.

To disable stream feeding, select "STREAM FEEDING" once again and press the [OK] key so that the checkmark is cleared from the checkbox.

ROTATION COPY

(When the dual function board is installed)

If the orientation of the original does not match that of the paper, the image can be rotated.

Rotation copy operates when automatic paper selection or automatic ratio selection operates. The function is initially enabled (factory default setting).



If the image is both rotated and reduced, the position of the copied image will vary depending on the orientations of the original and the paper.

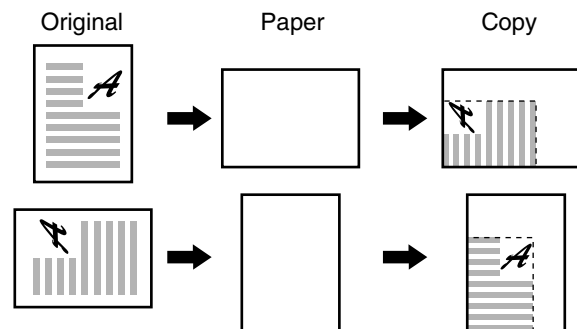

To enable rotation copy, select "ROTATION COPY" and press the [OK] key so that a checkmark appears in the checkbox.

To disable rotation copy, select "ROTATION COPY" once again and press the [OK] key so that the checkmark is cleared from the checkbox.

SORT AUTO SELECT

(When the dual function board is installed)

This program is used to select the default output mode when the SPF is used for copying. The initial factory setting is "SORT".

Select "SORT AUTO SELECT" and press the [OK] key. The following screen will appear.

SORT AUTO SELECT	
▲	NO SORT
▼	<input checked="" type="checkbox"/> SORT

- 1 Select the output mode with the [▼] or [▲] key.
- 2 Press the [OK] key.

RESOLUTION IN AUTO/TEXT MODE

This program is used to set the resolution used when the exposure mode is set to "AUTO" or "TEXT". When "300dpi" is selected, the first copy time is shorter than when "600dpi" is selected.

The factory default setting is "300dpi".

Select "RESOLUTION IN AUTO/TEXT MODE" and press the [OK] key. The following screen will appear.

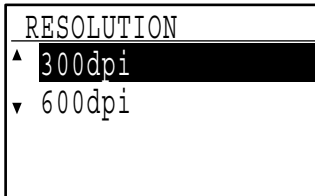

- 1** Press the [▼] or [▲] key to select the resolution.
- 2** Press the [OK] key.

PHOTO MODE DEFAULT

This program is used to select the method of expressing halftones when "PHOTO" is selected with the [EXPOSURE] key for a copy job. Select "PATTERN 1" or "PATTERN 2" for the method of expressing halftones.

"PATTERN 1" is recommended for printed photos, providing sharp images and good expression of outlines.

"PATTERN 2" is recommended for photos on photographic paper, providing a soft image. The factory default setting is "PATTERN 1".

Select "PHOTO MODE DEFAULT" and press the [OK] key. The following screen will appear.

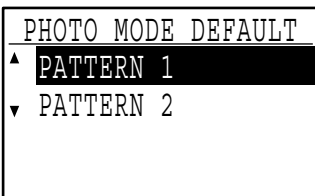

- 1** Select "PATTERN 1" or "PATTERN 2" with the [▼] or [▲] key.
- 2** Press the [OK] key.

LIMIT OF COPIES

This program is used to set the limit for the number of copies that can be set (and that can appear in the display) for one copy job.

The factory default setting is "999 copies".

Select "LIMIT OF COPIES" and press the [OK] key. The following screen will appear.

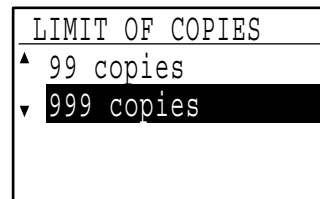

- 1** Select "99 copies" or "999 copies" with the [▼] or [▲] key.
- 2** Press the [OK] key.

DISABLE AUTO PAPER SELECTION

This program is used to disable automatic paper selection. When automatic paper selection is disabled, the most suitable paper is not selected automatically when an original is placed on the document glass or in the document feeder tray.

This function is initially disabled (factory default setting).

To disable auto paper selection, select "DISABLE AUTO PAPER SELECTION" and press the [OK] key so that a checkmark appears in the checkbox.

To re-enable auto paper selection, select "DISABLE AUTO PAPER SELECTION" once again and press the [OK] key so that the checkmark is cleared from the checkbox.

DISABLE 2-SIDED COPY

(Only on models that support two-sided printing)

Use this program when you wish to disable two-sided copying or when the two-sided function has failed. When this program is enabled, only one-sided printing is possible.

The function is initially disabled (factory default setting).

To disable two-sided copying, select "DISABLE 2-SIDED COPY" and press the [OK] key so that a checkmark appears in the checkbox.

To re-enable two-sided copying, select "DISABLE 2-SIDED COPY" once again and press the [OK] key so that the checkmark is cleared from the checkbox.

Date Revised : Aug.18, 2003

Date Issued : Jun. 1, 2003

MSDS No. F-01211

1.PRODUCT AND COMPANY IDENTIFICATION

Product Name : AR-202NT / AR-202T / AR-202ST / AR-202FT / AR-202ST-C / AR-203ST-C / AR-016T/ AR-016ST / AR-016FT / AR-016RT (Black Toner)

Supplier Identification : Sharp Corporation
22-22 Nagaike-cho, Abeno-ku, Osaka, Japan

Local suppliers are listed below. Please contact the nearest supplier for additional information.

Area	(Country)	(Name and Telephone Number)
North America	U.S.A.	Sharp Electronics Corporation Sharp Plaza, Mahwah, NJ Telephone number for information : 1-800-237-4277 Emergency telephone number : 1-800-255-3924
	Canada	Sharp Electronics of Canada Ltd. Telephone number for information : 905-890-2100 Emergency telephone number : 1-800-255-3924
Oceania	Australia	Sharp Corporation of Australia PTY. Ltd. No1 Huntingwood Drive Huntingwood Blacktown N.S.W. Telephone number for information : 1300-13-50-22
Europe	Germany	Sharp Electronics (Europe) GMBH Sonninstrasse 3, 20097 Hamburg Telephone number to access MSDS : 040-2376-2185 For more information : 040-2376-2613
	United Kingdom	Sharp Electronics (U. K.) Ltd. Telephone number for information : 08705-274-277
	France	Sharp Electronics France S.A. Telephone number for information : 01-49-90-34-00
	Austria	Sharp Electronics GMBH Telephone number for information : 01-727-19-0
	Italy	Sharp Electronics (Italy) S.P.A. Telephone number for information : 02895951
	Spain	Sharp Electronics (Espana) S.A. Telephone number for information : 93-581-97-00
	Netherlands	Sharp Electronics Benelux B.V. Telephone number for information : 30-6359500
	Sweden	Sharp Electronics Nordic AB Telephone number for information : 08-634-36-00
Middle East	U.A.E.	Sharp Electronics (Schweiz)AG Telephone number for information : 01-846-6111
		Sharp Middle East FZE P.O.Box 17115 Jebel Ali, Dubai Telephone number for information : 04-815311

2.COMPOSITION / INFORMATION ON INGREDIENTS

Substance[] Ingredient	Preparation[X] CAS No.	Proportion	OSHA PEL	ACGIH TLV	MAK-TWA	NOHSC-TWA
Styrene-Acrylate copolymer	29497-14-1	85-95 %	Not listed	Not listed	Not listed	Not listed
Carbon black	1333-86-4	5-10 %	3.5mg/m ³	3.5mg/m ³	Not listed	3mg/m ³
Iron oxide	1309-38-2	1-5 %	Not listed	Not listed	Not listed	Not listed
Metal Complex dye*	109125-51-1 84179-66-8	} < 2 %	0.5mg/m ³	0.5mg/m ³	Not listed	Not listed

* EC NO. : 400-110-2, Symbol letter : F, R Phrase : R11

Date Revised : Aug.18, 2003

Date Issued : Jun. 1, 2003

MSDS No. F-01211

3.HAZARDS IDENTIFICATION

Most Important Hazards and Effects of the Products

Human Health Effects : There are no anticipated carcinogenic effects from exposure based on animal tests performed using toner. When used as intended according to instructions, studies do not indicate any symptoms of fibrosis will occur.

Environmental Effects : No data are available.

Specific Hazards : Dust explosion (like most finely divided organic powders)

Directive 1999/45/EC(Europe) : Not classified as dangerous

4.FIRST-AID MEASURES

Route(s) of Entry : <u>Inhalation?</u>	<u>Skin?</u>	<u>Ingestion?</u>
Yes	No	Possible but very unusual.

Inhalation : Remove to fresh air. If symptoms occur, consult medical personnel.

Skin Contact : Wash with soap and water for 15 minutes or until particle is removed.
If irritation does occur, consult medical personnel.

Eye Contact : Flush eyes immediately with water for 15 minutes. If irritation does occur, consult medical personnel.

Ingestion : Rinse with water and drink several glasses of water. If irritation or discomfort does occur, consult medical personnel.

5.FIRE-FIGHTING MEASURES

Extinguishing Media : Water, CO₂, foam and dry chemicals

Special Fire Fighting Procedures : None

Fire and Explosion Hazards : Toner material, like most finely divided organic powders, may form an explosive mixture.

6.ACCIDENTAL RELEASE MEASURES

Personal Precautions : None

Environmental Precautions : None

Methods for Cleaning Up : Wipe off with paper or cloth. Do not use vacuum cleaner when a large amount is released. It, like most finely divided organic powders, is capable of creating a dust explosion.

7.HANDLING AND STORAGE

Handling

Technical Measures : None

Precautions : None

Safe Handling Advice : Use of a dust mask is recommended when handling a large quantity of toner or during long term exposure, as with any non-toxic dust. Try not to disperse the particles.

Storage

Technical Measures : None

Storage Conditions : Keep container closed and Store in a cool and dry place.
Keep out of the reach of children.

Incompatible Products : None

8.EXPOSURE CONTROLS / PERSONAL PROTECTION

Engineering Measures

Ventilation : Not required under intended use.

Date Revised : Aug.18, 2003

Date Issued : Jun. 1, 2003

MSDS No. F-01211

Exposure Limit Values

OSHA-PEL(USA) : 15mg/m³ (Total Dust), 5mg/m³ (Respirable Dust)
ACGIH-TLV(USA) : 10mg/m³ (Total Dust), 3mg/m³ (Respirable Dust)

Personal Protective Equipment

Respiratory Protection : Not required under intended use.
Hand Protection : Not required under intended use.
Eye Protection : Not required under intended use.
Skin Protection : Not required under intended use.
Other Protective Equipment : Use of a dust mask and goggles are recommended when handling a large quantity of toner or during long term exposure, as with any non-toxic dust.

9. PHYSICAL AND CHEMICAL PROPERTIES**Appearance**

Physical State : Solid Form : Powder Color : Black Odor : odorless

Ph : Not applicable

Boiling / Melting Point : Not applicable

Softening Point(°C) : 100 - 130

Flash Point(°C) : Not applicable

Ignition Point(°C) : > 350

Explosion Properties : No data

Density(g/cm³) : 1.1 (bulk density : 0.35)

Solubility in Water : Negligible

10. STABILITY AND REACTIVITY

Stability : Stable

Hazardous Reactions : Dust explosion, like most finely divided organic powders.

Conditions to Avoid : Electric discharge, throwing into fire.

Materials to Avoid : Oxidizing Materials

Hazardous Decomposition Products : CO, CO₂ and NO_x

Further Information : None

11. TOXICOLOGICAL INFORMATION**Acute Toxicity**

Ingestion(oral) : LD₅₀ > 2500mg/kg (Rats)

Inhalation : No Data

Eye irritation : Not an irritant (Rabbits)

Skin irritation : Not an irritant (Rabbits)

Skin sensitizer : No sensitization

Mutagenicity : Negative (Ames Test)

Carcinogenicity : In 1996 the IARC reevaluated carbon black as a Group 2B carcinogen (possible human carcinogen). This classification is given to chemicals for which there is inadequate human evidence, but sufficient animal evidence on which to base an opinion of carcinogenicity. The classification is based upon the development of lung tumors in rats receiving chronic inhalation exposures to free carbon black at levels that induce particle overload of the lung. Studies performed in animal models other than rats did not show any association between carbon black and lung tumors. Moreover, a two-year cancer bioassay using a typical toner preparation containing carbon black demonstrated no association between toner exposure and tumor development in rats.

Date Revised : Aug.18, 2003

Date Issued : Jun. 1, 2003

MSDS No. F-01211

Chronic Effect : In a study in rats of chronic inhalation exposure to a typical toner, a mild to moderate degree of lung fibrosis was observed in 92% of the rats in the high concentration (16mg/m³) exposure group, and a minimal to mild degree of fibrosis was noted in 22% of the animals in the middle (4mg/m³) exposure group, but no pulmonary change was reported in the lowest (1mg/m³) exposure group, the most relevant level to potential human exposures.

12.ECOLOGICAL INFORMATION

No data are available.

13.DISPOSAL CONSIDERATIONS

Waste from Residues : Waste material may be dumped or incinerated under conditions which meet all federal, state and local environmental regulations.

Contaminated Packaging : Waste may be disposed or incinerated under conditions which meet all federal, state and local environmental regulations.

14.TRANSPORT INFORMATION

UN Classification : None

Not classified as hazardous for transport.

15.REGULATORY INFORMATION

US Information

TSCA(Toxic Substances Control Act) :

All chemical substances in this product comply with all applicable rules or order under TSCA.

SARA(Superfund Amendments and Reauthorization Act) Title III

302 Extreme Hazardous Substance : None

311/312 Hazard Classification : None

EU Information

1999/45/EC and 67/548/EEC

Symbol & Indication : Not required

R-Phrase : Not required

76/769/EEC : All chemical substances in this product comply with all applicable rules or order under 76/769/EEC.

16.OTHER INFORMATION

NFPA Rating (USA) : Health=1 Flammability=1 Reactivity=0

WHMIS Legislation (Canada) : This product is not a controlled product.

List of R phrases : R11 : Highly flammable

References

IARC(1996) : IARC monographs on the Evaluation of the Carcinogenic Risk of Chemicals to Humans, Vol. 65, Printing Process And Printing Inks, Carbon Black and Some Nitro Compounds, Lyon, pp.149-261

H.Muhle, B.Bellmann, O.Creutzenberg, C.Dasenbrock, H.Ernst, R.Kilpper, J.C.MacKenzie, P.Morrow, U.Mohr, S.Takenaka, and R.Mermelstein(1991) Pulmonary Response to Toner upon Chronic Inhalation Exposure in Rats.

Fundamental and Applied Toxicology 17, pp.280-299.

The information on this data sheet represents our current data and best opinion as to the proper use in handling of this product under normal conditions. However, all materials may present unknown hazards and should be used with caution. Although certain hazards are described herein, we do not guarantee that these are the only hazards which exist.

Date Issued : Jun. 1, 2003
MSDS No. F-31211

1.PRODUCT AND COMPANY IDENTIFICATION

Product Name : AR-202ND / AR-202DV / AR-202SD / AR-202SD-C (Black Developer)
Supplier Identification : Sharp Corporation
22-22 Nagaike-cho, Abeno-ku, Osaka, Japan

Local suppliers are listed below. Please contact the nearest supplier for additional information.

Area	(Country)	(Name and Telephone Number)
North America	U.S.A.	Sharp Electronics Corporation Sharp Plaza, Mahwah, NJ Telephone number for information : 1-800-237-4277 Emergency telephone number : 1-800-255-3924
	Canada	Sharp Electronics of Canada Ltd. Telephone number for information : 905-890-2100 Emergency telephone number : 1-800-255-3924
Oceania	Australia	Sharp Corporation of Australia PTY. Ltd. No1 Huntingwood Drive Huntingwood Blacktown N.S.W. Telephone number for information : 1300-13-50-22
Europe	Germany	Sharp Electronics (Europe) GMBH Sonninstrasse 3, 20097 Hamburg Telephone number to access MSDS : 040-2376-2185 For more information : 040-2376-2613
	United Kingdom	Sharp Electronics (U. K.) Ltd. Telephone number for information : 08705-274-277
	France	Sharp Electronics France S.A. Telephone number for information : 01-49-90-34-00
	Austria	Sharp Electronics GMBH Telephone number for information : 01-727-19-0
	Italy	Sharp Electronics (Italy) S.P.A. Telephone number for information : 02895951
	Spain	Sharp Electronics (Espana) S.A. Telephone number for information : 93-581-97-00
	Netherlands	Sharp Electronics Benelux B.V. Telephone number for information : 30-6359500
	Sweden	Sharp Electronics Nordic AB Telephone number for information : 08-634-36-00
Middle East	Switzerland	Sharp Electronics(Schweiz)AG Telephone number for information : 01-846-6111
	U.A.E.	Sharp Middle East FZE P.O.Box 17115 Jebel Ali, Dubai Telephone number for information : 04-815311

2.COMPOSITION / INFORMATION ON INGREDIENTS

Substance[]	Preparation[X]					
Ingredient	CAS No.	Proportion	OSHA PEL	ACGIH TLV	MAK-TWA	NOHSC-TWA
Iron powder	7439-89-6	> 90 %	Not listed	Not listed	Not listed	Not listed
Styrene-Acrylate copolymer	29497-14-1	5-10 %	Not listed	Not listed	Not listed	Not listed
Carbon black	1333-86-4	< 1 %	3.5mg/m ³	3.5mg/m ³	Not listed	3mg/m ³

Date Issued : Jun. 1, 2003
MSDS No. F-31211

3. HAZARDS IDENTIFICATION

Most Important Hazards and Effects of the Products

Human Health Effects : There are no anticipated carcinogenic effects from exposure based on animal tests performed using toner. When used as intended according to instructions, studies do not indicate any symptoms of fibrosis will occur.

Environmental Effects : No data are available.

Specific Hazards : Dust explosion (like most finely divided organic powders)

Directive 1999/45/EC(Europe) : Not classified as dangerous

4. FIRST-AID MEASURES

Route(s) of Entry : Inhalation?

No

Skin?

No

Ingestion?

Possible but very unusual.

Inhalation : Remove to fresh air. If symptoms occur, consult medical personnel.

Skin Contact : Wash with soap and water for 15 minutes or until particle is removed.
If irritation does occur, consult medical personnel.

Eye Contact : Flush eyes immediately with water for 15 minutes. If irritation does occur, consult medical personnel.

Ingestion : Rinse with water and drink several glasses of water. If irritation or discomfort does occur, consult medical personnel.

5. FIRE-FIGHTING MEASURES

Extinguishing Media : Water, CO₂, foam and dry chemicals

Special Fire Fighting Procedures : None

Fire and Explosion Hazards : Toner material, like most finely divided organic powders, may form an explosive mixture.

6. ACCIDENTAL RELEASE MEASURES

Personal Precautions : None

Environmental Precautions : None

Methods for Cleaning Up : Wipe off with paper or cloth. Do not use vacuum cleaner when a large amount is released. It, like most finely divided organic powders, is capable of creating a dust explosion.

7. HANDLING AND STORAGE

Handling

Technical Measures : None

Precautions : None

Safe Handling Advice : Use of a dust mask is recommended when handling a large quantity of toner or during long term exposure, as with any non-toxic dust. Try not to disperse the particles.

Storage

Technical Measures : None

Storage Conditions : Keep container closed and Store in a cool and dry place.
Keep out of the reach of children.

Incompatible Products : None

8. EXPOSURE CONTROLS / PERSONAL PROTECTION

Engineering Measures

Ventilation : Not required under intended use.

Date Issued : Jun. 1, 2003
MSDS No. F-31211**Exposure Limit Values**OSHA-PEL(USA) : 15mg/m³ (Total Dust), 5mg/m³ (Respirable Dust)
ACGIH-TLV(USA) : 10mg/m³ (Total Dust), 3mg/m³ (Respirable Dust)**Personal Protective Equipment**Respiratory Protection : Not required under intended use.
Hand Protection : Not required under intended use.
Eye Protection : Not required under intended use.
Skin Protection : Not required under intended use.
Other Protective Equipment : Use of a dust mask and goggles are recommended when handling a large quantity of toner or during long term exposure, as with any non-toxic dust.**9. PHYSICAL AND CHEMICAL PROPERTIES****Appearance**

Physical State : Solid Form : Powder Color : Black Odor : odorless

Ph : Not applicable**Boiling / Melting Point** : Not applicable**Flash Point(°C)** : Not applicable**Ignition Point(°C)** : No data**Explosion Properties** : No data**Density(g/cm³)** : 7.3 (bulk density : 2.0)**Solubility in Water** : Negligible**10. STABILITY AND REACTIVITY****Stability** : Stable**Hazardous Reactions** : Dust explosion, like most finely divided organic powders.**Conditions to Avoid** : Electric discharge, throwing into fire.**Materials to Avoid** : Oxidizing Materials**Hazardous Decomposition Products** : CO, CO₂ and NO_x**Further Information** : None**11. TOXICOLOGICAL INFORMATION****Acute Toxicity**Ingestion(oral) : LD₅₀ > 2500mg/kg (Rats)

Inhalation : No data

Eye irritation : No data

Skin irritation : Not an irritant (Rabbits)

Skin sensitizer : No sensitization

Mutagenicity : Negative (Ames Test)**Carcinogenicity** : In 1996 the IARC reevaluated carbon black as a Group 2B carcinogen (possible human carcinogen). This classification is given to chemicals for which there is inadequate human evidence, but sufficient animal evidence on which to base an opinion of carcinogenicity. The classification is based upon the development of lung tumors in rats receiving chronic inhalation exposures to free carbon black at levels that induce particle overload of the lung. Studies performed in animal models other than rats did not show any association between carbon black and lung tumors. Moreover, a two-year cancer bioassay using a typical toner preparation containing carbon black demonstrated no association between toner exposure and tumor development in rats.

Date Issued :Jun. 1, 2003

MSDS No. F-31211

Chronic Effect : In a study in rats of chronic inhalation exposure to a typical toner, a mild to moderate degree of lung fibrosis was observed in 92% of the rats in the high concentration (16mg/m³) exposure group, and a minimal to mild degree of fibrosis was noted in 22% of the animals in the middle (4mg/m³) exposure group, but no pulmonary change was reported in the lowest (1mg/m³) exposure group, the most relevant level to potential human exposures.

12.ECOLOGICAL INFORMATION

No data are available.

13.DISPOSAL CONSIDERATIONS

Waste from Residues : Waste material may be dumped or incinerated under conditions which meet all federal, state and local environmental regulations.

Contaminated Packaging : Waste may be disposed or incinerated under conditions which meet all federal, state and local environmental regulations.

14.TRANSPORT INFORMATION

UN Classification : None

Not classified as hazardous for transport.

15.REGULATORY INFORMATION

US Information

TSCA(Toxic Substances Control Act) :

All chemical substances in this product comply with all applicable rules or order under TSCA.

SARA(Superfund Amendments and Reauthorization Act) Title III

302 Extreme Hazardous Substance : None

311/312 Hazard Classification : None

EU Information

1999/45/EC and 67/548/EEC

Symbol & Indication : Not required

R-Phrase : Not required

76/769/EEC : All chemical substances in this product comply with all applicable rules or order under 76/769/EEC.

16.OTHER INFORMATION

NFPA Rating (USA) : Health=1 Flammability=1 Reactivity=0

WHMIS Legislation (Canada) : This product is not a controlled product.

References

IARC(1996) : IARC monographs on the Evaluation of the Carcinogenic Risk of Chemicals to Humans, Vol. 65, Printing Process And Printing Inks, Carbon Black and Some Nitro Compounds, Lyon, pp.149-261

H.Muhle, B.Bellmann, O.Creutzenberg, C.Dasenbrock, H.Ernst, R.Kilpper, J.C.MacKenzie, P.Morrow, U.Mohr, S.Takenaka, and R.Mermelstein(1991) Pulmonary Response to Toner upon Chronic Inhalation Exposure in Rats. Fundamental and Applied Toxicology 17, pp.280-299.

The information on this data sheet represents our current data and best opinion as to the proper use in handling of this product under normal conditions. However, all materials may present unknown hazards and should be used with caution. Although certain hazards are described herein, we do not guarantee that these are the only hazards which exist.

INDEX

Symbols / Numbers

[*] key	15
2 in 1 / 4 in 1 copy	66
250-sheet paper feed unit / 2 x 250-sheet paper feed unit	41
[2-SIDED COPY] key	15
2-sided printing.....	18

A

[ACC.#-C] key	15, 23
Arrow keys	15
Auditing mode	23
Auto clear	17, 46, 83
[AUTO IMAGE] key	15
Auto paper select mode	47
Auto power shut-off	85
Auto power shut-off mode	17
Auto power shut-off timer	85
Auto tray switching	22, 49

B

[BACK] key	14
Base screen	18
Beep	84
Bypass tray	13, 18, 20, 61
Bypass tray extension	13, 20
Bypass tray guides	13, 20
Bypass tray paper feed roller	37

C

[C] key	14, 46
[CA] key.....	15, 18
Card shot.....	71
Centre tray	12
Charger cleaner	12, 38
Checking the total output count.....	36
Cleaning the machine	
- Bypass tray paper feed roller	37
- Document glass and SPF/document cover.....	37
- Transfer charger	38
Cleaning the transfer charger.....	38
Copy functions	45
[COPY] key / indicator	14
Copy number display	14
[COPY RATIO] key	15

D

DATA indicator	14, 15
Default settings	18
Developer replacement required icon	28
Disable auto paper selection	88
Display	14, 16, 39
Document cover	13
- Cleaning.....	37
- Removing.....	47
Document feeder tray.....	13
Document glass	12, 45
- Cleaning.....	37
- Normal copying	45
- Two-sided copies of one-sided originals	58
Dual page copy	62

E

Envelopes	20
Erase copy	69
Exit area	13
Exposure	
- Making a copy darker or lighter	48
[EXPOSURE] key	15, 48

F

[FAX] key / indicator	15
[FAX STATUS] key	14
Features	10
Feeding roller cover	13, 29
Front cover	12
Fusing unit paper guide.....	13, 33
Fusing unit release levers	13, 32

G

Glass cleaner	12, 37
---------------------	--------

H

Handles	12
---------------	----

I

Indicators and display messages	28
Installation requirements	8
INTERRUPT indicator	14, 63
[INTERRUPT] key	14

J

Job separator tray kit.....	12
-----------------------------	----

K

Key operator code	75
Key operator program list	77
Key operator programs	75

L		R	
LINE indicator.....	15	[READ-END] key.....	15
LINE STATUS indicator	15	Reducing or enlarging a copy	
Loading paper	18	- Automatic ratio selection.....	52
Loading paper in the bypass tray.....	20	- Preset copy ratios/zoom.....	52
		- XY zoom copying	54
M		Removing the document cover	47
Main features	10	Replacing the toner cartridge	35
Maintenance icon	28	Reversing tray	13, 29
Manuals provided with the product	9	Right side cover	13, 29
Margin shift.....	68	Roller rotating knob	13, 31, 32
Message.....	28	Rotation copy	64
Misfeed removal.....	29	RSPF	
- Bypass tray	30	- One-sided copies of two-sided originals	60
- In the machine	31	- Two-sided copies of two-sided originals	59
- SPF	29		
- Tray 1	33	S	
- Tray 2.....	34	[SCAN] key / indicator	14
		Selecting the tray	49
N		Setting the number of copies	49
Normal copying		Side cover	13
- Copying from the document glass	45	Side cover handle	13
- Copying from the SPF.....	46	[SPECIAL FUNCTION] key	15
Numeric keys	14	Specifications	73
		SPF	46
O		- Acceptable originals	47
Offset function	63, 65	- Cleaning.....	37
[OK] key	14	- Original misfeed	29
ONLINE indicator	14	- Two-sided copying of one-sided originals	57
Operation in copy, print, scan, and fax modes.....	16	Standard sizes	50
Operation panel.....	12, 14	[START] indicator	15
Original guides	13, 46	[START] key.....	15, 46
Original misfeed	29	Storage of supplies	42
[OUTPUT] key.....	15	Stream feeding.....	87
		Stream feeding mode	46
P			
Paper.....	18	T	
[PAPER SELECT] key	15	Toner cartridge	13, 35
Parallel port	12	Toner cartridge lock release lever	13, 35
Part names and functions	12	Toner cartridge replacement required icon	28
Photoconductive drum	13	Top tray	12
Power off	17	Tray 1	12
Power on	17	Tray 2	12
Power save modes.....	17	Troubleshooting	
Power switch	12, 17	- Machine/copying problems	25
Preheat mode.....	17	Troubleshooting and maintenance	24
Press the [INTERRUPT] key.....	63	Two-sided copies using the bypass tray	61
[PRINT] key / indicator	14	Two-sided copying	56
Problem.....	25		
Product configurations	3	U	
		USB 1.1 port (USB-1).....	12
		USB 2.0 (Hi-Speed mode)	83
		USB 2.0 port (USB-2).....	12
		Z	
		Zoom	52

INDEX BY PURPOSE

Convenient copy functions

2 in 1 / 4 in 1 copy	66
Card shot.....	71
Erase copy	69
Margin shift.....	68
Rotation copy	64
Sort mode.....	64

Copying

Automatic ratio selection	52
Dual page copy	62
Interrupt copying	63
Making a copy darker or lighter	48
Manual ratio selection (preset copy ratios/zoom).....	52
Normal copying	
- Copying from the document glass	45
- Copying from the SPF.....	46
One-sided copies of two-sided originals	60
Placing the original	
- Document glass	45
- SPF	46
Reducing or enlarging a copy	52
Removing the document cover	47
Selecting the original size.	50
Selecting the tray.	49
Setting the number of copies	49
Two-sided copies of two-sided originals	59
Two-sided copies using the bypass tray	61
Two-sided copying of one-sided originals	57
Using the bypass tray to copy a special size original.....	51
XY zoom copying	54

Copying, starting

Document glass	45
SPF	46

Troubleshooting

Misfeed removal	
- Bypass tray	30
- In the machine	31
- SPF	29
- Tray 1	33
- Tray 2.....	34
Problem.....	25

KEY OPERATOR CODE NUMBER: FACTORY SETTING

The following is the factory setting of the Key Operator Code Number, which must be used to access the Key Operator Program.

Factory setting = 00000

This number must be entered when accessing the Key Operator Program for the first time. (Page 76)



- The Key Operator Code Number is an important security number allowing the Key Operator to configure the copier's functions and auditor's settings.
- You should register your own code number – different from the factory setting above – immediately after your copier is installed.
- Detach this page and store it in a safe place.

This equipment complies with the requirements of Directives 89/336/EEC and 73/23/EEC as amended by 93/68/EEC.

Dieses Gerät entspricht den Anforderungen der EG-Richtlinien 89/336/EWG und 73/23/EWG mit Änderung 93/68/EWG.

Ce matériel répond aux exigences contenues dans les directives 89/336/CEE et 73/23/CEE modifiées par la directive 93/68/CEE.

Dit apparaat voldoet aan de eisen van de richtlijnen 89/336/EEG en 73/23/EEG, gewijzigd door 93/68/EEG.

Dette udstyr overholder kravene i direktiv nr. 89/336/EEC og 73/23/EEC med tillæg nr. 93/68/EEC.

Quest' apparecchio è conforme ai requisiti delle direttive 89/336/EEC e 73/23/EEC, come emendata dalla direttiva 93/68/EEC.

Este equipamento obedece às exigências das directivas 89/336/CEE e 73/23/CEE, na sua versão corrigida pela directiva 93/68/CEE.

Este aparato satisface las exigencias de las Directivas 89/336/CEE y 73/23/CEE, modificadas por medio de la 93/68/CEE.

Denna utrustning uppfyller kraven enligt riktlinjerna 89/336/EEC och 73/23/EEC så som kompletteras av 93/68/EEC.

Dette produktet oppfyller betingelsene i direktivene 89/336/EEC og 73/23/EEC i endringen 93/68/EEC.

Tämä laite täyttää direktiivien 89/336/EEC ja 73/23/EEC vaatimukset, joita on muutettu direktiivillä 93/68/EEC.

Η συσκευή αυτή πληρεί τις πρόνοιες των Οδηγιών 89/336/ΕΟΚ και 73/23/ΕΟΚ του Συμβουλίου όπως έχουν τροποποιηθεί από την Οδηγία 93/68/ΕΟΚ του Συμβουλίου.

Bu cihaz Konsey Direktifi 93/68/EEC tarafından düzeltilen 89/336/EEC ve 73/23/EEC Konsey Direktiflerinin gerekliliklerine uygundur.

Tento přístroj je v souladu s požadavky směrníc rady 89/336/EEC a 73/23/EEC, tak jak byly upraveny směrníci rady 93/68/EEC.

See seade on vastavuses Nõukogu Direktiivis nr 89/336/EEC ja 73/23/EEC esitatud nõuetega, vastavalt Nõukogu Direktiivis nr 93/68/EEC esitatud parandustele.

Ez a készülék megfelel a Tanács által kiadott, 89/336/EGK és 73/23/EGK Irányelveknek és az utóbbi módosító 93/68/EGK Irányelvnek.

Ši ierice atbilst tehniskam prasibam pec 89/336/EEC un 73/23/EEC direktivam papildinats ar direktivu 93/68/EEC.

Šis prietaisas atitinka ES Tarybos direktyvu 89/336/EEC ir 73/23/EEC patikslintos direktyvos 93/68/EEC reikalavimus.

To urządzenie spełnia wymagania dyrektyw 89/336/EEC i 73/23/EEC wraz z poprawkami dyrektywy 93/68/EEC.

Tento přístroj je v súlade s požiadavkami smerníc rady 89/336/EEC a 73/23/EEC tak ako boli upravené smernicou rady 93/68/EEC.

Ta aparat je v skladu z zahtevami Direktiv Sveta 89/336/EEC in 73/23/EEC kot je navedeno v dopolnilu k Direktivi Sveta 93/68/EEC.

The CE mark logo label is affixed on an equipment in case that the directives described in the above sentence are applicable to the product. (This sentence is not applicable in any country where the above directives are not required.)

SHARP®

SHARP CORPORATION