



POSEICO SPA
Power SEmiconductors Italian COrporation

POSEICO SPA
Via N. Lorenzi 8, 16152 Genova - ITALY
Tel. ++ 39 010 6556234 - Fax ++ 39 010 6557519
Sales Office:
Tel. ++ 39 010 6556775 - Fax ++ 39 010 6442510

RECTIFIER DIODE

AR2004

Repetitive voltage up to **2400 V**
Mean forward current **2525 A**
Surge current **28 kA**

FINAL SPECIFICATION

nov 02 - ISSUE : 05

| Symbol | Characteristic | Conditions | T _j [°C] | Value | Unit |
|----------------------|-------------------------------------|--|------------------------|-------------|------------------|
| BLOCKING | | | | | |
| V _{RRM} | Repetitive peak reverse voltage | | 175 | 2400 | V |
| V _{RSM} | Non-repetitive peak reverse voltage | | 175 | 2500 | V |
| I _{RRM} | Repetitive peak reverse current | V=VRRM | 175 | 50 | mA |
| CONDUCTING | | | | | |
| I _{F(AV)} | Mean forward current | 180° sin ,50 Hz, Th=55°C, double side cooled | | 2525 | A |
| I _{F(AV)} | Mean forward current | 180° sin ,50 Hz, Tc=85°C, double side cooled | | 2485 | A |
| I _{FSM} | Surge forward current | Sine wave, 10 ms without reverse voltage | 175 | 28 | kA |
| I ² t | I ² t | | | 3920 x 1E3 | A ² s |
| V _{FM} | Forward voltage | Forward current = 3400 A | 25 | 1.30 | V |
| V _{F(TO)} | Threshold voltage | | 175 | 0.80 | V |
| r _F | Forward slope resistance | | 175 | 0.165 | mohm |
| SWITCHING | | | | | |
| t _{rr} | Reverse recovery time | | 175 | | µs |
| Q _{rr} | Reverse recovery charge | | | | µC |
| I _{rr} | Peak reverse recovery current | | | | A |
| MOUNTING | | | | | |
| R _{th(j-h)} | Thermal impedance, DC | Junction to heatsink, double side cooled | | 26 | °C/kW |
| R _{th(c-h)} | Thermal impedance | Case to heatsink, double side cooled | | 6 | °C/kW |
| T _j | Operating junction temperature | | | -30 / 175 | °C |
| F | Mounting force | | | 18.0 / 20.0 | kN |
| | Mass | | | 500 | g |

ORDERING INFORMATION : AR2004 S 24

standard specification VRRM/100

DISSIPATION CHARACTERISTICS

SQUARE WAVE

Th [°C]

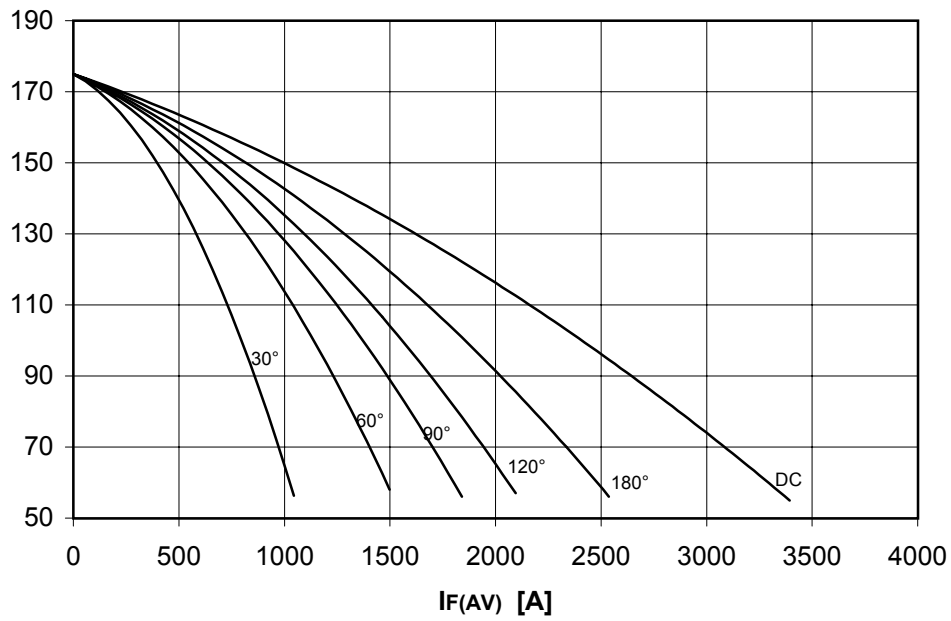

PF(AV) [W]

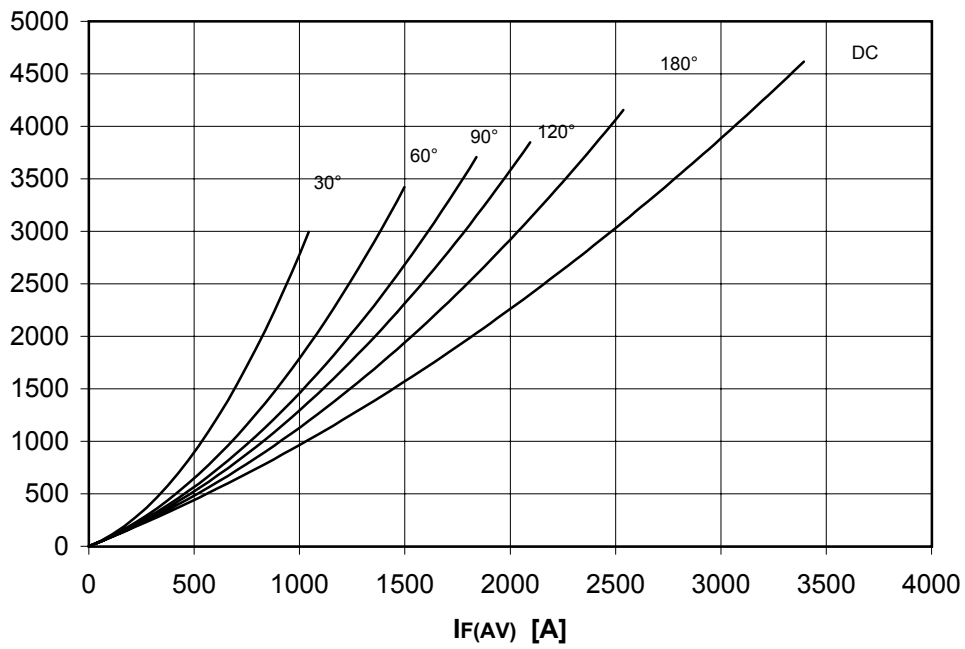

DISSIPATION CHARACTERISTICS

SINE WAVE

Th [°C]

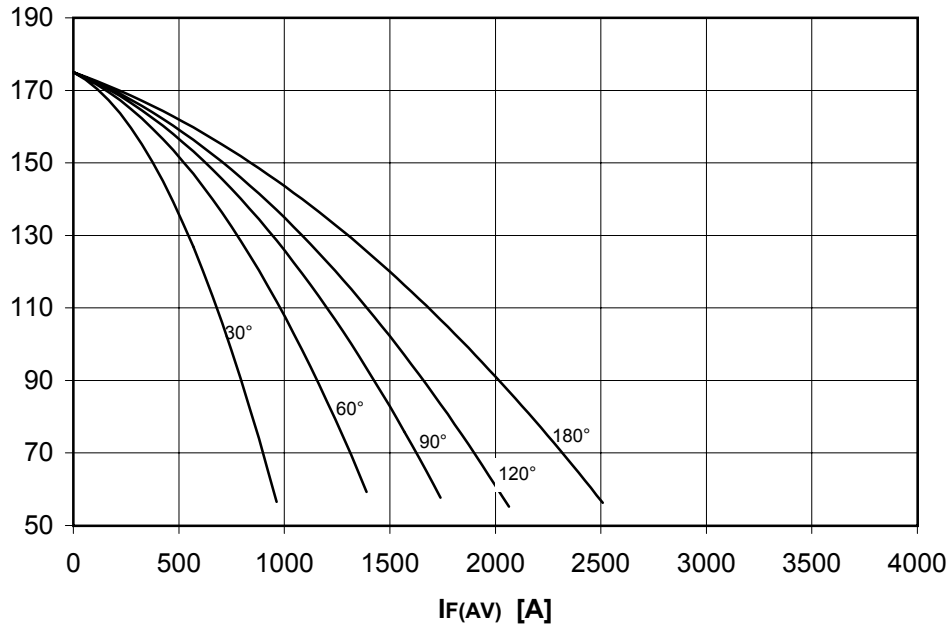

PF(AV) [W]

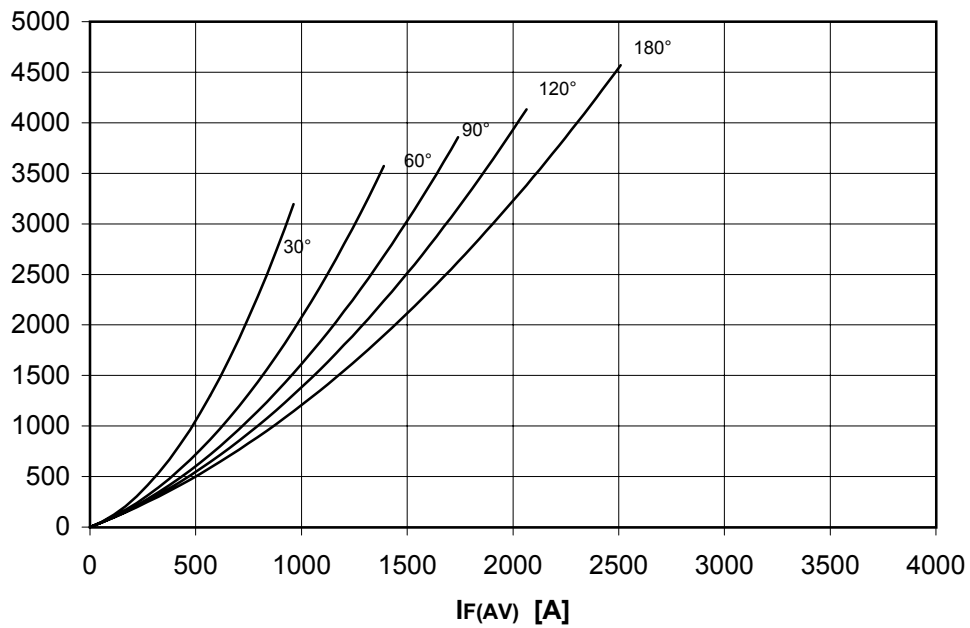

AR2004 RECTIFIER DIODE

FINAL SPECIFICATION nov 02 - ISSUE : 05

FORWARD CHARACTERISTIC
 $T_J = 175^\circ\text{C}$

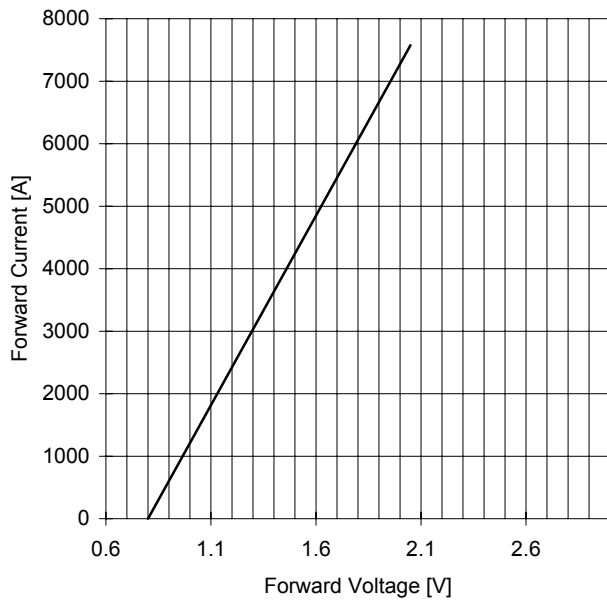

SURGE CHARACTERISTIC
 $T_J = 175^\circ\text{C}$

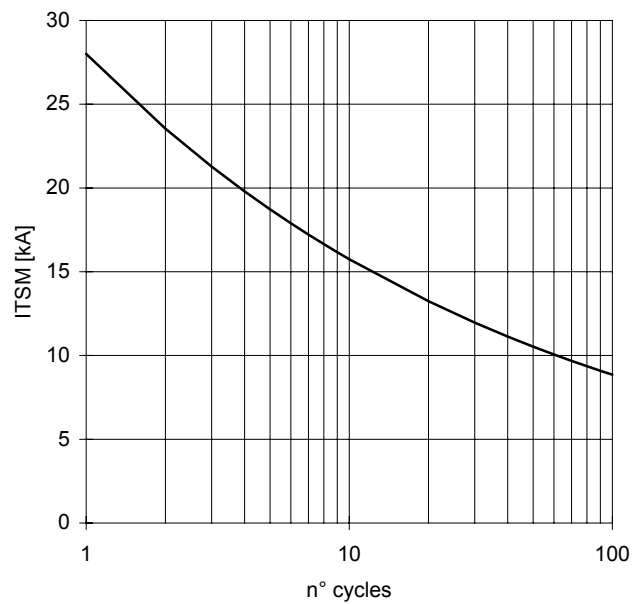

TRANSIENT THERMAL IMPEDANCE
DOUBLE SIDE COOLED

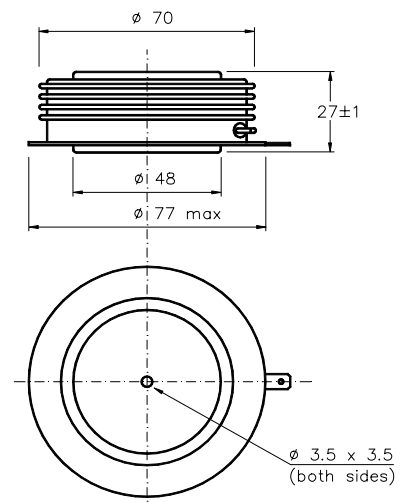
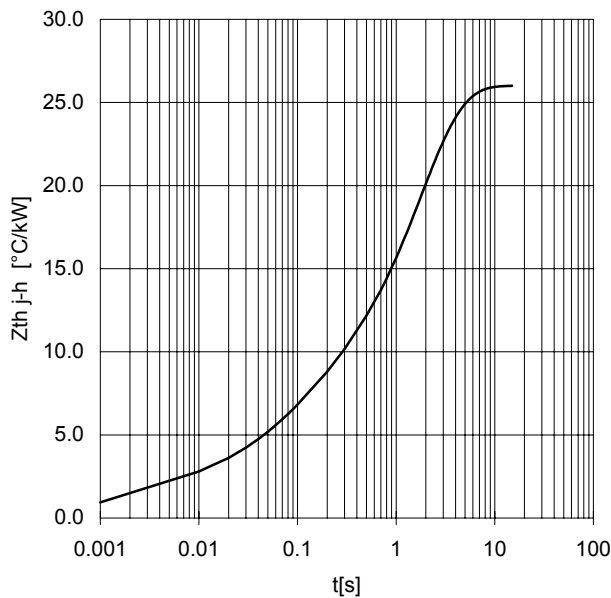

Dimensions
in mm



All the characteristics given in this data sheet are guaranteed only with uniform clamping force, cleaned and lubricated heatsink, surfaces with flatness $< .03 \mu\text{m}$ and roughness $< 2 \mu\text{m}$.

In the interest of product improvement POSEICO Spa reserves the right to change any data given in this data sheet at any time without previous notice.

If not stated otherwise the maximum value of ratings (symbols over shaded background) and characteristics is reported.

Distributed by

