

Description

The AR30N60 is a high-performance Active/Synchronous Rectifier used for secondary-side synchronous rectification with the output voltage at less than 10V.

By integrating MOSFET and controller, the AR30N60 emulates the characteristics of a near-ideal diode rectifier. The combination not only reduces the energy consumption of the secondary-side synchronous rectifier, it also improves the power dissipation of the sub-system on the primary side.

The SYNC feature allows the embedded MOSFET of the AR30N60 to immediately turn OFF as soon as the primary-side switch turns ON, preventing the unfavorable reverse condition of the synchronous rectifier. The AR30N60 is ideally suited for AC/DC power converters implemented in either the flyback or the LLC-resonant topology. For the ease of use, the design of AR30N60 is flexible enough to facilitate operation in one of the following modes: Discontinuous Conduction (DCM), Continuous Conduction (CCM), Quasi Resonant (QR).

To further improve conversion efficiency and to ensure system integrity, AR30N60 integrates many innovative features. These include: light-load detection to reduce standby power consumption, TON and TOFF/EN pins to prevent run-away ON-time due to the open-circuit or short-circuit fault conditions, SFB pin to provide over-temperature protection, low $R_{DS(ON)}$ of the embedded MOSFET, and wide output voltage (V_{CC}) range.

The small footprint of the V-DFN6040-22 package makes it ideally suited for space constrained applications.

Features

- Secondary-side synchronous rectification
- Low Turn-OFF threshold at -4mV
- Wide operating temperature range from -40°C to +150°C
- Supports DCM, CCM, and QR (Quasi-Resonant) operating modes
- Built-in fault handling mechanism to provide high level of system stability: over-temperature (OTP) and over-voltage (OVP) protection under-voltage lock-out (UVLO)
- Light-load detection to reduce the standby power consumption
- **Totally Lead-free & Fully RoHS Compliant (Notes 1 & 2)**
- **Halogen and Antimony Free. "Green" Device (Note 3)**

- Notes:
1. No purposely added lead. Fully EU Directive 2002/95/EC (RoHS) & 2011/65/EU (RoHS 2) compliant.
 2. See http://www.diodes.com/quality/lead_free.html for more information about Diodes Incorporated's definitions of Halogen- and Antimony-free, "Green" and Lead-free.
 3. Halogen- and Antimony-free "Green" products are defined as those which contain <900ppm bromine, <900ppm chlorine (<1500ppm total Br + Cl) and <1000ppm antimony compounds.

Pin Assignments

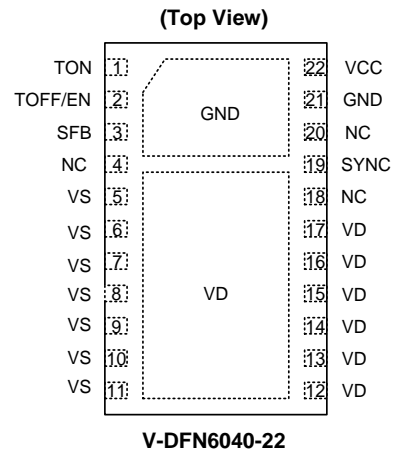

Applications

- Switched-mode power supply (SMPS) in consumer products (e.g. FPTV), web servers, and storage servers
- Power adapter and charger with either fixed or variable output voltage (e.g. USB Type-C, PD, fast charging, ...) in notebook PCs, desktop PCs, All-In-One PCs, tablets, smartphones, and network clients
- Industrial and measuring equipment

Typical Application Circuit

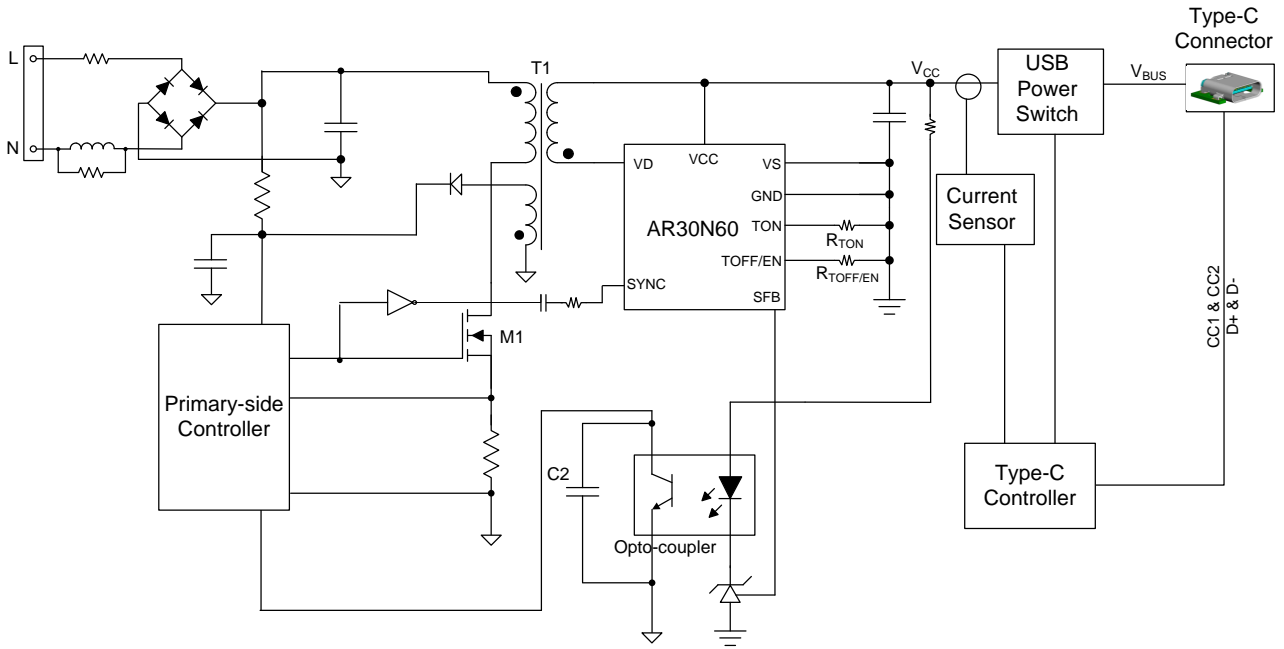

Figure 1. USB Type-C Charger with Secondary-side Regulation (SSR)

Pin Description

Pin Number	Pin Name	Function
1	TON	Minimum ON-time Control Input. The resistor, R_{TON} , shall be connected between this pin and GND to create a voltage reference for the circuit inside the device.
2	TOFF/EN	Minimum OFF-time / Enable Control Input. It combines the functions of setting the Minimum OFF-time as well as chip enable. The resistor, $R_{TOFF/EN}$, shall be connected between this pin and GND.
3	SFB	Secondary-side Feedback Output. It is connected to the internal resistor network for feedback purpose.
4,18,20	NC	No Connection.
5-11	VS	Embedded MOSFET Source Terminal Input. It shall be connected to GND.
12-17, VD Pad	VD	Embedded MOSFET Drain Terminal Input. It shall be connected as close as possible to the transformer.
19	SYNC	Synchronization Input. This must be connected, through a RC filter, to either the output of the gate driver to the embedded MOSFET of the primary-side, or to the drain terminal of the MOSFET of the primary-side.
21,GND Pad	GND	Ground Pin.
22	VCC	IC Supply Voltage Input. A ceramic capacitor of 10 μ F shall be connected between this pin and GND.

Functional Block Diagram

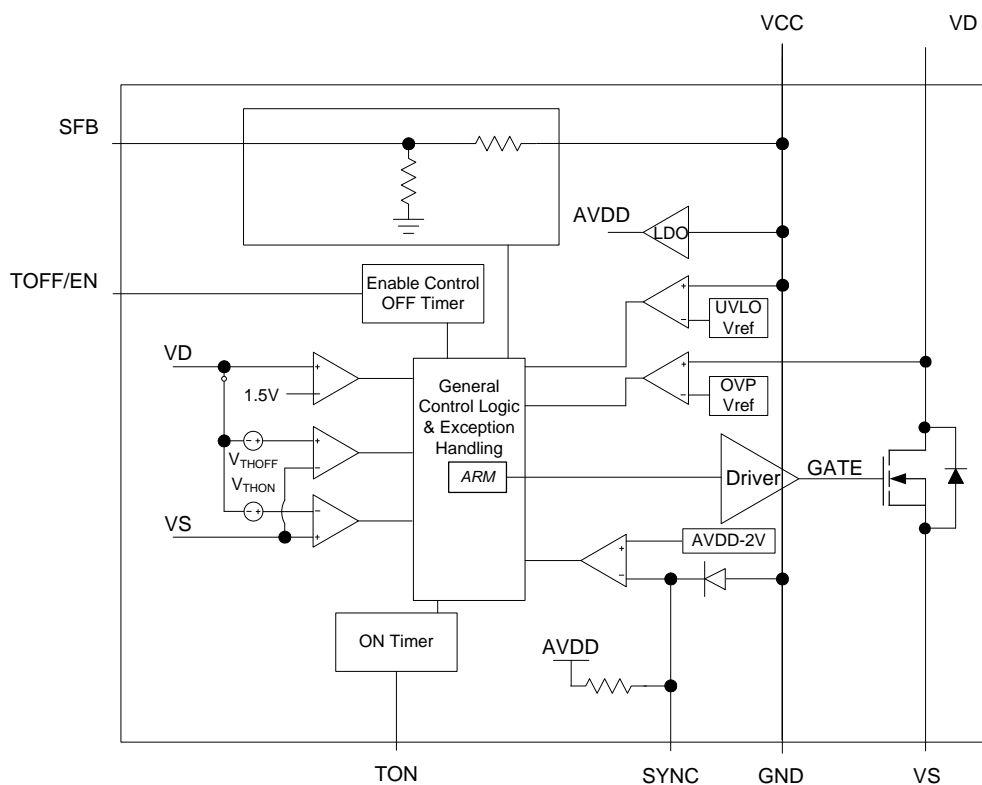

Figure 2. Internal Functional Block Diagrams of AR30N60

Absolute Maximum Ratings (@ $T_A = +25^\circ\text{C}$, unless otherwise specified.) (Note 4)

Symbol	Parameter	Ratings	Unit
V_{CC}	Supply Voltage	-0.3 to 10.0	V
V_{DS}	Voltage Across Drain and Source	-1 to 60	V
$V_{TOFF/EN}, V_{TON}$	Voltage on TOFF/EN, TON Pins	-0.3 to 6.0	V
T_{MJ}	Maximum Junction Temperature	+150	$^\circ\text{C}$
T_{ST}	Storage Temperature	-65 to +150	$^\circ\text{C}$
ESD	Human Body Model, JESD22-A114	3.0	KV
	Machine Model, JESD22-A115-A	0.25	
	Charged Device Model, JESD22-C101	1.0	

Note: 4. These are stress ratings only. Operation outside the absolute maximum ratings may cause device failure. Operation at the absolute maximum rating for extended periods may reduce device reliability.

Package Thermal Data (@ $T_A = +25^\circ\text{C}$, unless otherwise specified.)

Symbol	Parameter	Rating	Unit
P_D	Power Dissipation (Note 5)	2.39	W
θ_{JA}	Thermal Resistance, Junction-to-Ambient (Note 6)	52.2	$^\circ\text{C}/\text{W}$
θ_{JC}	Thermal Resistance, Junction-to-Case (Note 7)	2.3	$^\circ\text{C}/\text{W}$

Notes: 5. Device mounted on FR-4 PCB, 2oz with minimum recommended pad layout.
 6. Device mounted on 25mm x 25mm 2oz copper board.
 7. Device mounted on 50mm x 50mm 2oz copper board.

Recommended Operating Conditions

Symbol	Parameter	Min	Max	Unit
V_{CC}	Supply Voltage Range	3.5	9.0	V
V_{DS}	Voltage across Drain and Source	-0.6	60.0	
F_{SW}	Switching Frequency	20	600	KHz
R_{TON}	TON Resistor	5	125	K Ω
$R_{TOFF/EN}$	TOFF/EN Resistor w/ SYNC	100	125	
T_J	Operating Junction Temperature	-40	+125	$^\circ\text{C}$

Electrical Characteristics (@ T_A = +25°C, unless otherwise specified.)

Symbol	Parameter	Conditions	Min	Typ	Max	Unit
V _{AVDD}	Internal Regulator Output	V _{CC} = 5V	–	4.5	–	V
I _{CC_START}	Supply Current (Under-voltage)	V _{CC} = 2.6V	–	160	–	μA
I _{CC_STANDBY}	Supply Current (Disabled)	V _{CC} = 5V, R _{TOFF/EN} = 0Ω	–	380	500	
I _{CC_ON}	Supply Current (Enabled)	V _{CC} = 5V, R _{TOFF/EN} = 100kΩ	–	2.9	3.8	mA
V _{EN_ON}	TOFF/EN Turn-on Threshold, Rising	TOFF/EN Driven, V _{TON} > 0.6V	1.3	1.4	1.5	V
V _{EN_OFF}	TOFF/EN Turn-off Threshold, Falling	TOFF/EN Driven, V _{TON} < 0.2V	0.55	0.60	0.65	
I _{EN_START}	TOFF/EN Input Current, device during startup	R _{TOFF/EN} = 50KΩ	-22	-20	-18	μA
I _{EN_ON}	TOFF/EN Input Current, device enabled	R _{TOFF/EN} = 100KΩ	-10.7	-10.0	-9.3	
Under-voltage Lock-out (UVLO)						
UVLO _{TH}	VCC Under-voltage Lock-out Threshold Rising	–	2.8	3.0	3.2	V
UVLO _{HYS}	VCC Under-voltage Lock-out Threshold Hysteresis	–	–	200	–	mV
MOSFET Voltage Sensing						
V _{THARM}	Arming Threshold	V _D to GND, Rising	1.3	1.5	1.7	V
V _{THON}	MOSFET Turn-ON Threshold	(V _D - V _S) Falling, V _S = GND = 0V	-200	-130	-70	mV
V _{THOFF}	MOSFET Turn-OFF Threshold	(V _D - V _S) Rising, V _S = GND = 0V, V _{CC} ≥ 4.2V	–	-4	–	mV
		(V _D - V _S) Rising, V _S = GND = 0V, 2.8V < V _{CC} < 4.2V	-30	-20	-10	mV
TD _{ON}	MOSFET Turn-ON Propagation Delay	V _{THON} to 20% Level on Rising of V _{GS} of Embedded MOSFET	–	30	–	ns
TD _{OFF}	MOSFET Turn-OFF Propagation Delay	V _{THOFF} to 80% Level on Falling of V _{GS} of Embedded MOSFET	–	30	–	
MOSFET Static Characteristics						
R _{DS(ON)}	Drain Source ON Resistance	V _{CC} = 5V, I _D = 10A	–	15	30	mΩ
Minimum ON-time						
T _{ON}	Minimum ON-time	R _{TON} = 8.25KΩ	0.26	0.34	0.42	μs
		R _{TON} = 100KΩ	2.25	3.00	3.75	
Minimum OFF-time						
T _{OFF}	Minimum OFF-time w/ SYNC	R _{TOFF/EN} = 100KΩ	–	0.5	–	μs
		R _{TOFF/EN} = 125KΩ	–	0.9	–	
		V _{TOFF} = 4V	–	1.0	–	
Synchronization						
V _{THSYNC}	SYNC Falling Threshold		V _{AVDD} - 2.4	V _{AVDD} - 2.0	V _{AVDD} - 1.6	V
T _{SDLY}	SYNC Propagation Delay	SYNC Falling 50% to MOSFET Turn-OFF	–	40	70	ns
R _{SYNC}	SYNC Pull-up Resistor to V _{AVDD}		–	2.0	–	KΩ
Exception Handling						
T _{OTP}	Over-temperature	–	–	+150	–	°C
T _{RECOVER}	Temperature to Recover from Over-temperature Exception	–	–	+125	–	
Fault Detection	Minimum ON-time Resistance Fault	–	–	–	5	KΩ
		150	–	–	–	

Typical Performance Characteristics

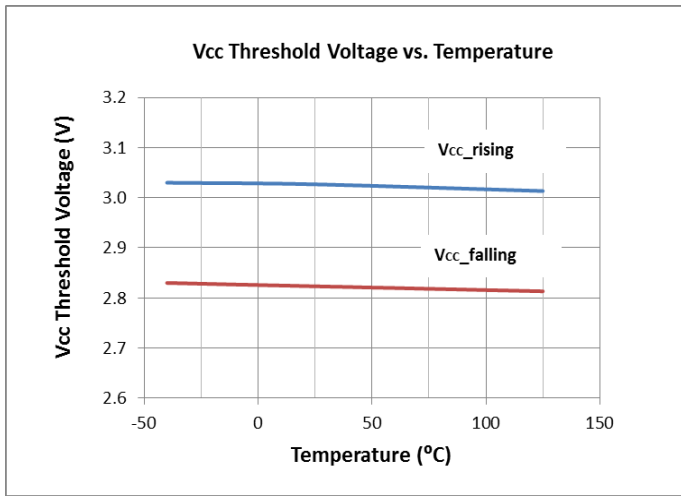

Figure 3

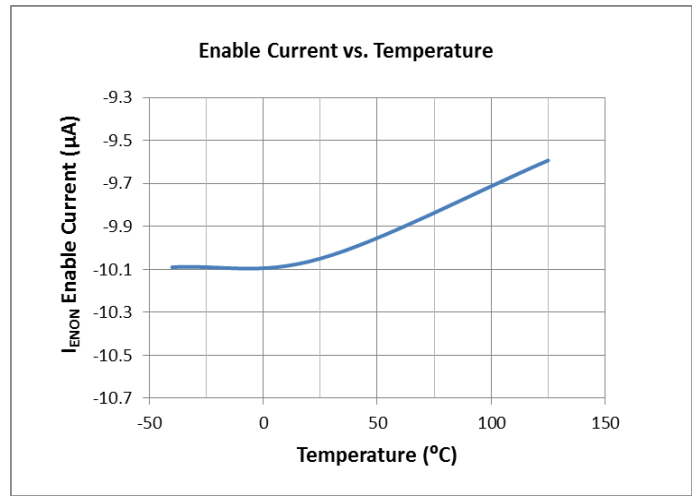

Figure 4

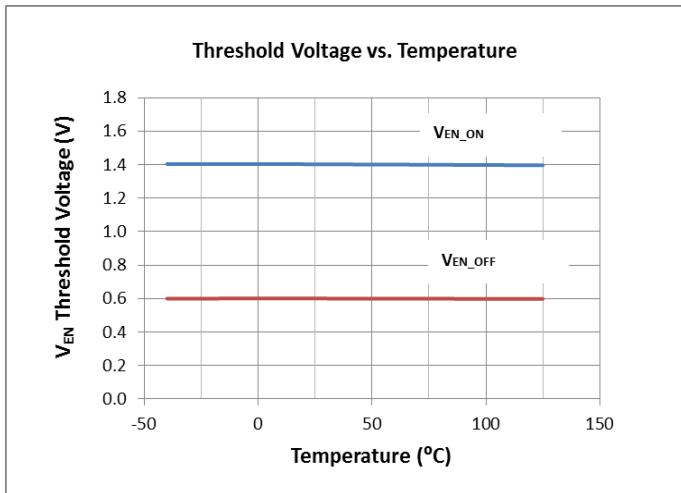

Figure 5

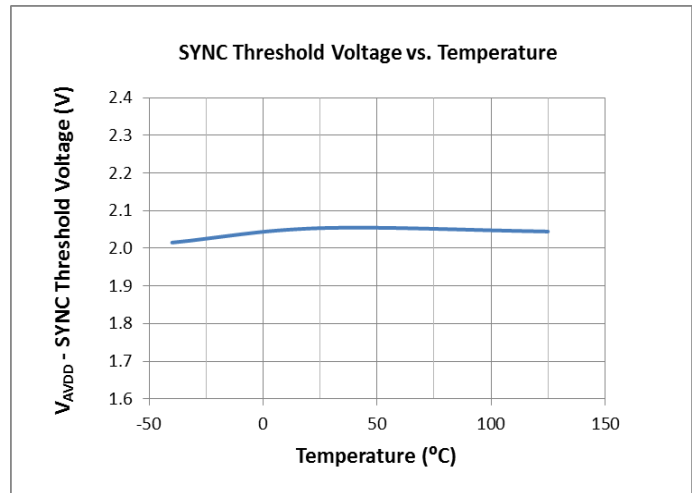

Figure 6

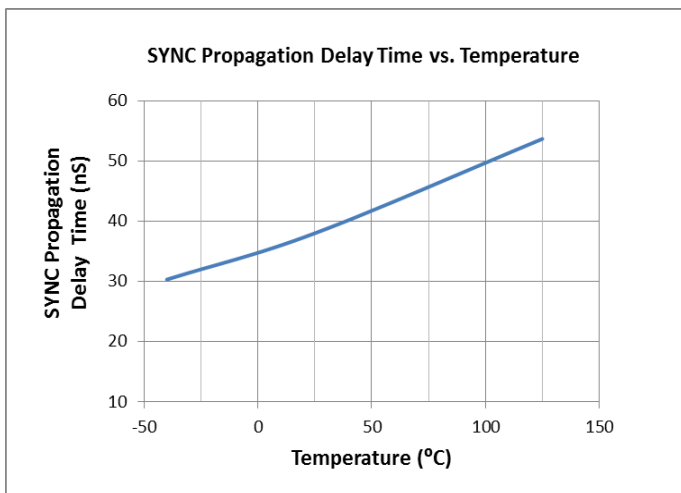

Figure 7

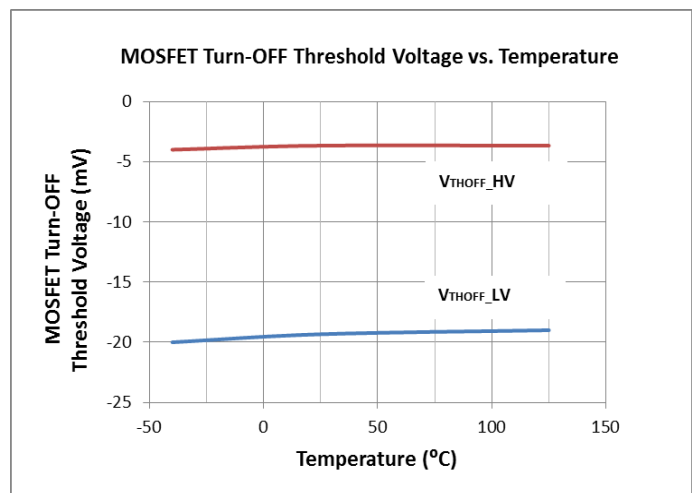

Figure 8

Typical Performance Characteristics (Cont.)

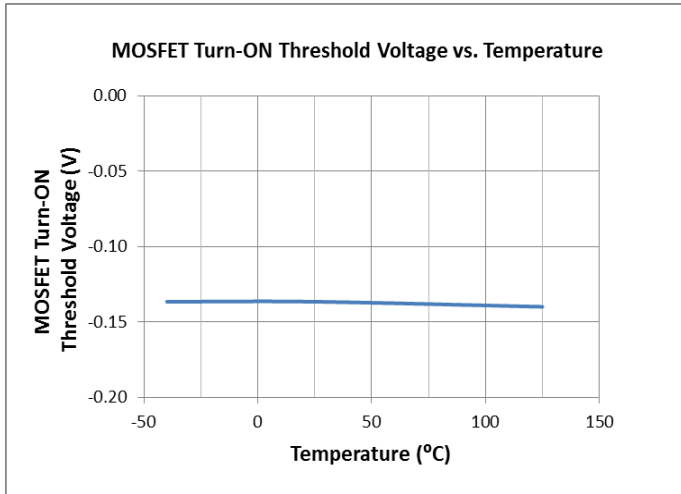

Figure 9

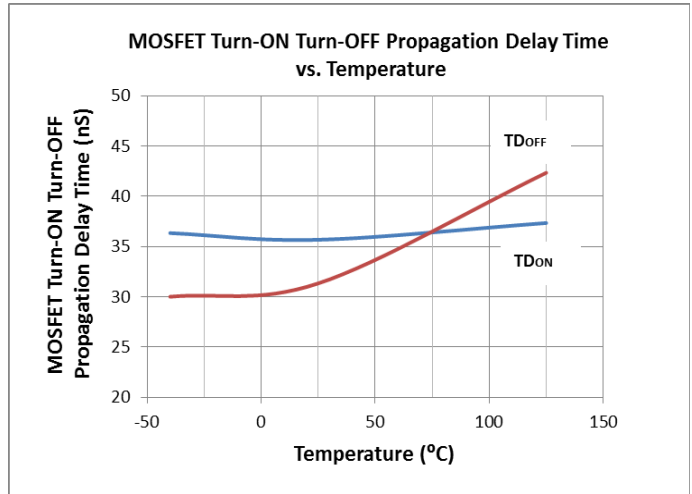

Figure 10

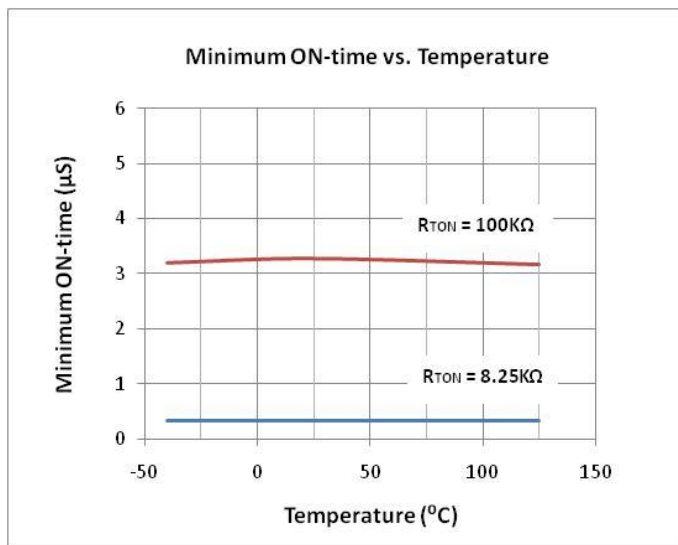

Figure 11

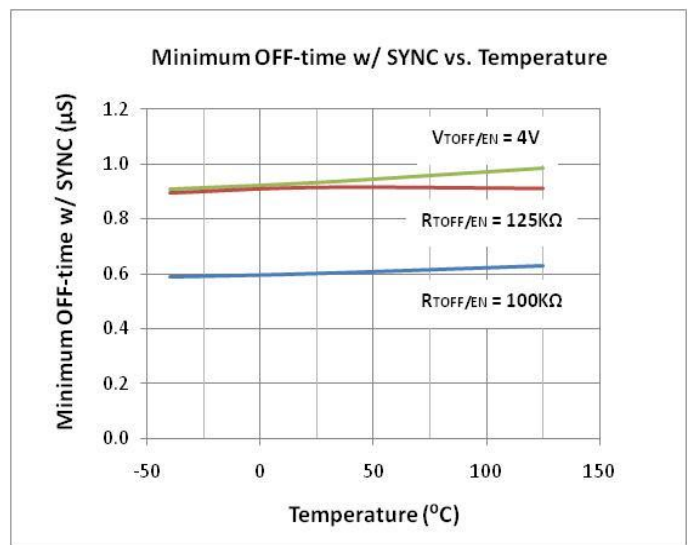

Figure 12

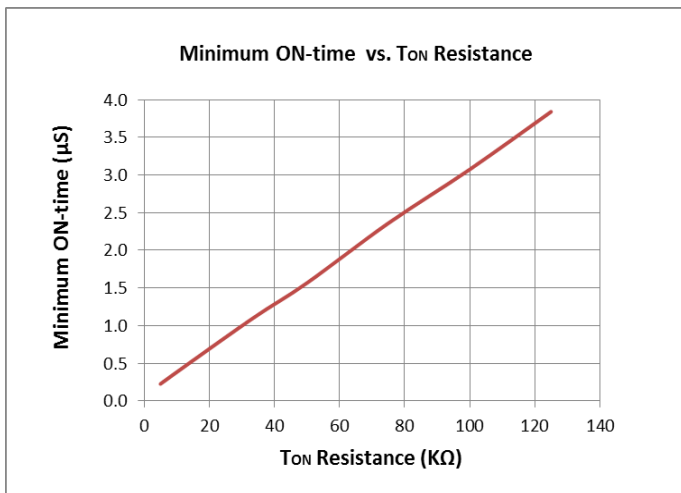

Figure 13

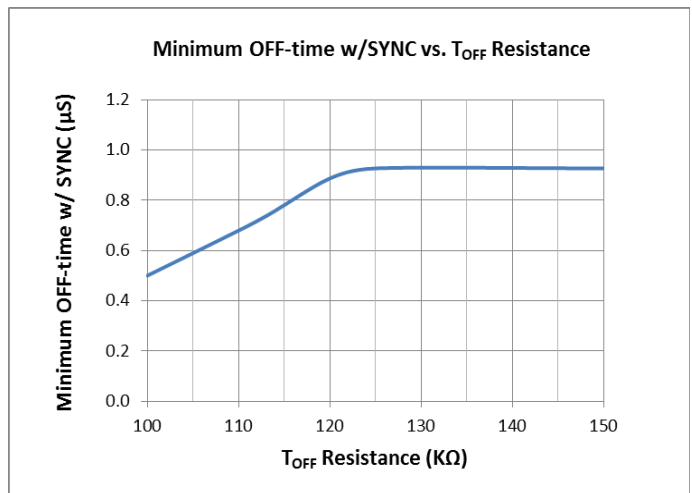

Figure 14

Application Information

General Description

The AR30N60 is an Active/Synchronous Rectifier with embedded MOSFET. Together, with a primary-side controller of the typical flyback architecture, a compact AC/DC power conversion system with high efficiency can be built. The AR30N60 is applicable to both the PSR implementation where space is at a premium and the SSR implementation where the highest possible efficiency is often needed.

Operating under the SSR mode, the AR30N60 provides the necessary feedback to the primary-side controller via the highly popular AS431 and the widely available opto-coupler. Innovative techniques like near-zero voltage detection are incorporated into the design to extend the ON time of the embedded MOSFET to maximize the power conversion efficiency. In addition, the AR30N60 also works in exact synchronization to the primary-side controller through the SYNC pin to mitigate the risk of shoot-through.

If the output of the voltage differentiator ($V_{DS} = V_D - V_S$) falls below the turn-OFF threshold (V_{THOFF}) of the embedded MOSFET within the minimum ON-time period (T_{ON}), the AR30N60 will transition into the Light-load Mode at the next cycle. When the load condition changes such that $V_{DS} \approx V_{THOFF}$, the AR30N60 reverts to its nominal mode of operation after the T_{ON} timer expires.

Before the embedded MOSFET can be set, the voltage level of V_{DS} must be greater than the arming threshold (V_{THARM}) and the Minimum OFF-time (T_{OFF}) timer must be reset. Once these conditions are met and the voltage internally sensed over the VD pin is 150mV lower than the VS pin, the embedded MOSFET is turned ON, and the T_{ON} timer starts decrementing. The embedded MOSFET will remain ON for at least the length of the T_{ON} period. This can only be overridden when a negative pulse is detected over the SNYC pin. After the T_{ON} timer expires, the embedded MOSFET remains ON until $V_{DS} \approx V_{THOFF}$, at which point the embedded MOSFET is turned OFF. As iterated before, if the condition [$V_{DS} \approx V_{THOFF}$] becomes true before the T_{ON} timer expires, the AR30N60 will enter the Light-load Mode. Consequently, the embedded MOSFET shall stay OFF at the next cycle. When the drain voltage V_D increases to 1.5V, the T_{OFF} timer shall start decrementing, during which the embedded MOSFET is prevented from being turning ON.

The SYNC pin is pulled-up internally through a 2K Ω resistor to the AVDD. It is nominally at 4.5V. The pin is typically driven by the primary-side controller to turn ON/OFF the embedded MOSFET. Once the voltage level at the SYNC pin falls by more than 2V, the embedded MOSFET inside the AR30N60 shall be turned OFF. Note that an external resistor should be used to limit the input current to less than 2mA.

When the AR30N60 operates under CCM, shoot-through between the MOSFET on the primary-side and the embedded MOSFET on the secondary-side must be avoided. That is, one MOSFET must be turned OFF before the other one is going to be turned ON. In Figures 1 & 2, the recommended connection for the SYNC pin is shown. Whenever the gate of primary-side controller pulls 'H', a pulse signal shall be transmitted via an RC filter to the SYNC pin as a "pull-down signal". As a result, the embedded MOSFET is turned OFF before the MOSFET on the primary-side can be fully turned ON. To avoid the fault condition while the MOSFET on the primary-side is still ON, the T_{OFF} timer shall start decrementing whenever the SYNC pin is "pulled down". After the T_{OFF} timer expires, the AR30N60 starts responding to the V_{DS} signal at the next cycle.

In summary, the SYNC pin shall always be terminated in the application circuit on the primary-side to ensure proper system operation. In addition, the protection and fault detection schemes like UVLO and OTP are incorporated in the AR30N60 to guarantee system reliability.

Modes of Operation

Sleep Mode

The Sleep Mode is a low-power operating mode. Entry is triggered when the voltage level appearing at the TOFF/EN pin becomes lower than the $V_{TOFF/EN}$ threshold. Under the Sleep Mode, current consumed by the AR30N60 is close to $I_{CC_STANDBY}$ while the overall power consumption is down to 1mW or less.

Upon entry into Sleep Mode, the embedded MOSFET along with the other blocks are turned OFF to minimize the power consumption. Once the voltage level at the TOFF/EN pin rises above the V_{EN_ON} , the AR30N60 shall exit Sleep Mode and transition into the Light-Load Mode. This transition typically takes around 25 μ s during which the internal circuits are powered up in an orderly manner.

Regardless of the mode at which the AR30N60 is operating, the AR30N60 can be forced into the Sleep Mode whenever the voltage level at the TOFF/EN pin drops to zero. The transition shall be immediate.

Application Information (Cont.)

Light-Load Mode

When the inductor current on the secondary-side is small, the body-diode of the embedded MOSFET likely conducts for a time period much less than T_{ON} . As long as the conduction time is less than T_{ON} , the embedded MOSFET shall stay OFF. The voltage across the body-diode, V_{DS} , is being monitored continuously. If the body-diode conduction time is larger than T_{ON} , the AR30N60 shall transition into the Active Mode at the next cycle.

Active Mode

This is the normal operation mode under which the inductor current is large enough and the body-diode conduction time is larger than T_{ON} . During the ON time, V_{DS} is masked from affecting the operating status of the embedded MOSFET. At the expiration of the T_{ON} timer, monitoring of the V_{DS} resumes. As soon as $V_{DS} \approx V_{THOFF}$, the embedded MOSFET is turned OFF. At the next cycle, the embedded MOSFET shall be turned ON if and only if:

- 1) the ON time of the embedded MOSFET in the previous cycle is larger than T_{ON} and
- 2) $V_{DS} < V_{THON}$

If the ON time of the embedded MOSFET at the last cycle becomes (for whatever reason), less than the T_{ON} , AR30N60 shall transition into the Light-load Mode at the next immediate cycle. In general, the embedded MOSFET alternates between the ON and OFF states in accordance to the values of the following parameters: V_{DS} , T_{ON} , T_{OFF} , voltage level at the SYNC pin.

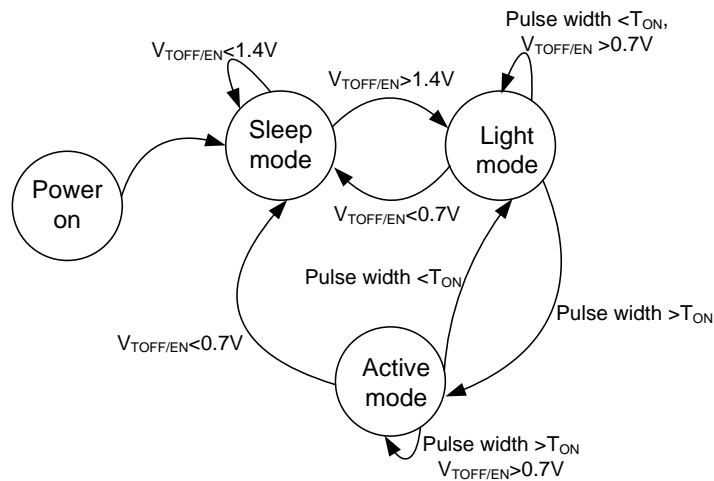

Figure 16 State Diagram

Fault Detection and System Protection

Over-temperature Protection

When the temperature of the AR30N60 rises above T_{OTP} , the output of the SFB pin shall be pulled up. As a result, the primary-side controller is informed of the abnormal condition via the typical opto-coupler. The primary-side controller typically responds by shutting down the whole operation. Note that the OTP protection mechanism has a built-in hysteresis of $+25^{\circ}\text{C}$ to minimize false triggering.

UVLO Protection

Whenever the voltage level at the VCC pin falls below 2.8V (i.e. $UVLO_{TH} - UVLO_{HYS}$), the UVLO protection shall be invoked. The embedded MOSFET is then turned OFF. Once the voltage level at the VCC pin rises above the $UVLO_{TH}$, the AR30N60 will return to the normal operation at the next cycle.

Application Information (Cont.)

Device Power-On

When $V_{CC} < UVLO_{TH}$, the AR30N60 transitions into the Sleep Mode. At this time, the TOFF/EN pin is connected to ground through an internal resistor.

When the V_{CC} rises above $UVLO_{TH}$, an internal current source starts to operate and eventually delivers $20\mu A$ (I_{EN_START}) to the external resistor, $R_{TOFF/EN}$, which is connected to the TOFF/EN pin. Assuming a typical value of $R_{TOFF/EN} \geq 70K\Omega$, the $V_{TOFF/EN}$ eventually reaches $1.4V$ (V_{EN_ON}) and above. Then, the AR30N60 shall exit the Sleep Mode and transition into the Light-load Mode. Thereafter, the internal current source shall reduce the output current to $10\mu A$ (I_{EN_ON}).

ON Timer Setting

The T_{ON} period is set by adding a resistor between the TON pin and ground. During typical operation, the OFF/ON of the embedded MOSFET is typically followed by successive oscillation in declining amplitude, i.e. ringing. This is caused by the parasitic existed on the printed circuit board. Activating the T_{ON} timer prevents the AR30N60 from responding to the ringing. Once the T_{ON} timer starts decrementing, the voltage level of V_{DS} is ignored. After the T_{ON} timer expires, the value of V_{DS} shall be checked continuously. Eventually, one of the following two situations shall become true:

- 1) If $V_{DS} \geq V_{THOFF}$, the embedded MOSFET is turned OFF. The AR30N60 shall enter the Light-load Mode at the next cycle.
- 2) If the voltage level of the V_{DS} remains substantially lower than the V_{THOFF} , the embedded MOSFET shall remain ON. When $V_{DS} \geq V_{THOFF}$, the AR30N60 shall be turned OFF. If, for whatever reason, V_{DS} remains lower than V_{THOFF} , the primary-side controller eventually shall turn OFF the AR30N60. Regardless, the AR30N60 will enter the Active Mode at the next cycle.

$$T_{ON} (\mu S) = 0.028\mu S/K\Omega \times R_{TON} + 0.1\mu S; \text{ where } 0.24\mu S \leq T_{ON} \leq 4.3\mu S, 5K\Omega \leq R_{TON} \leq 125K\Omega$$

OFF Timer Setting

In the typical applications of AR30N60 as illustrated in Figures 1 & 2, the SYNC pin is connected to the primary-side controller. The embedded MOSFET is turned OFF whenever one of the following conditions becomes true:

- 1) $V_{DS} \approx V_{THOFF}$
- 2) The voltage level at the SYNC pin is pulled low

While the T_{OFF} timer ensures that the embedded MOSFET stays OFF when the primary-side is conducting, the value of T_{OFF} is set by an external resistor, $R_{TOFF/EN}$. The value of $R_{TOFF/EN}$ can be calculated from the following equation,

$$T_{OFF} (\mu S) = [0.019\mu S/K\Omega \times R_{TOFF/EN} (K\Omega)] - 1.4\mu S; \text{ where } 0.5\mu S \leq T_{OFF} \leq 1.0\mu S, 100K\Omega \leq R_{TOFF/EN} \leq 125K\Omega$$

Application Information (Cont.)

MOSFET Turn-ON/OFF Control Sequence

DCM Operation with SYNC-pin Connected

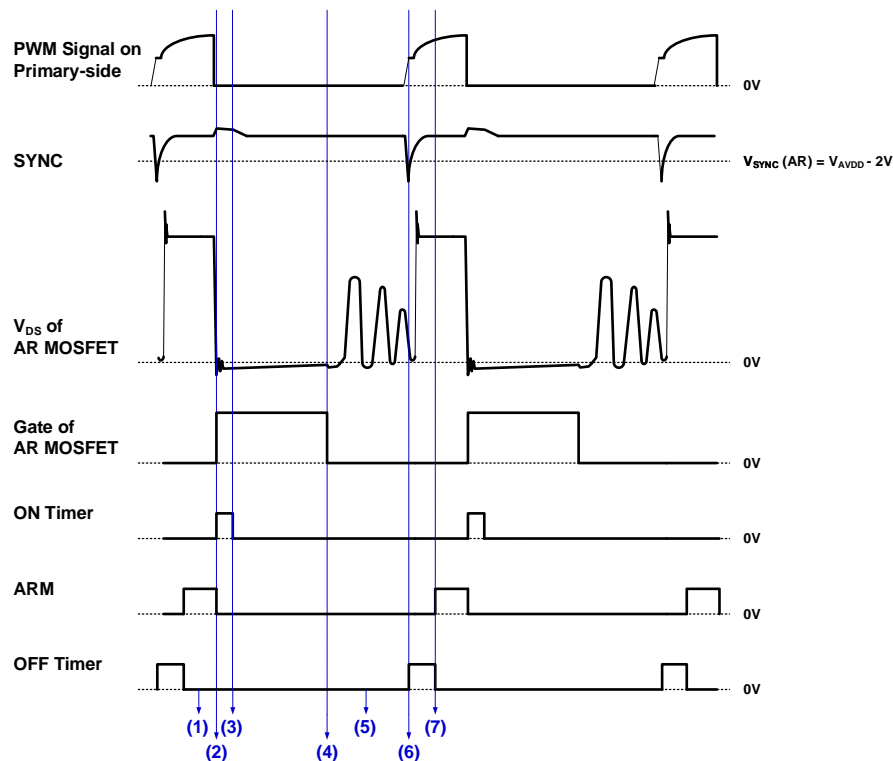

Steps of Operation

- (1) At the logic 'H' of the internal signal ARM, the voltage level of V_{DS} shall be checked continuously. At this time, no current should flow through the embedded MOSFET (neither its body-diode).
- (2) When the primary-side controller stops conducting, the transfer of energy to the secondary-side commences. At this time, the current flowing through the body-diode of embedded MOSFET shall rise rapidly. When $V_{\text{DS}} \leq V_{\text{THON}}$ (-130mV typical), the embedded MOSFET is turned ON, the T_{ON} timer starts decrementing, and the ARM signal is reset. Before the T_{ON} timer expires, the embedded MOSFET shall remain ON.
- (3) Now, the T_{ON} timer expires. If V_{DS} is still lower than V_{THOFF} , the embedded MOSFET shall remain ON.
- (4) Eventually, the current flowing through the embedded MOSFET falls to zero. Once $V_{\text{DS}} \approx V_{\text{THOFF}}$, the embedded MOSFET shall be turned OFF.
- (5) Because the ARM signal remains at the OFF state, the embedded MOSFET is kept at the OFF state even if $V_{\text{DS}} \leq V_{\text{THON}}$. That is, the value of V_{DS} is ignored.
- (6) The primary-side controller starts conducting. This causes the signal at the input of the SYNC pin to be pulled down. As soon as the condition $[V_{\text{SYNC}} < (V_{\text{AVDD}} - 2V)]$ becomes true, the T_{OFF} timer starts decrementing.
- (7) After the T_{OFF} timer expires, the AR30N60 starts to monitor the voltage level of V_{DS} as soon as the ARM signal becomes 'H'.

Application Information (Cont.)

CCM Operation with SYNC-pin Connected

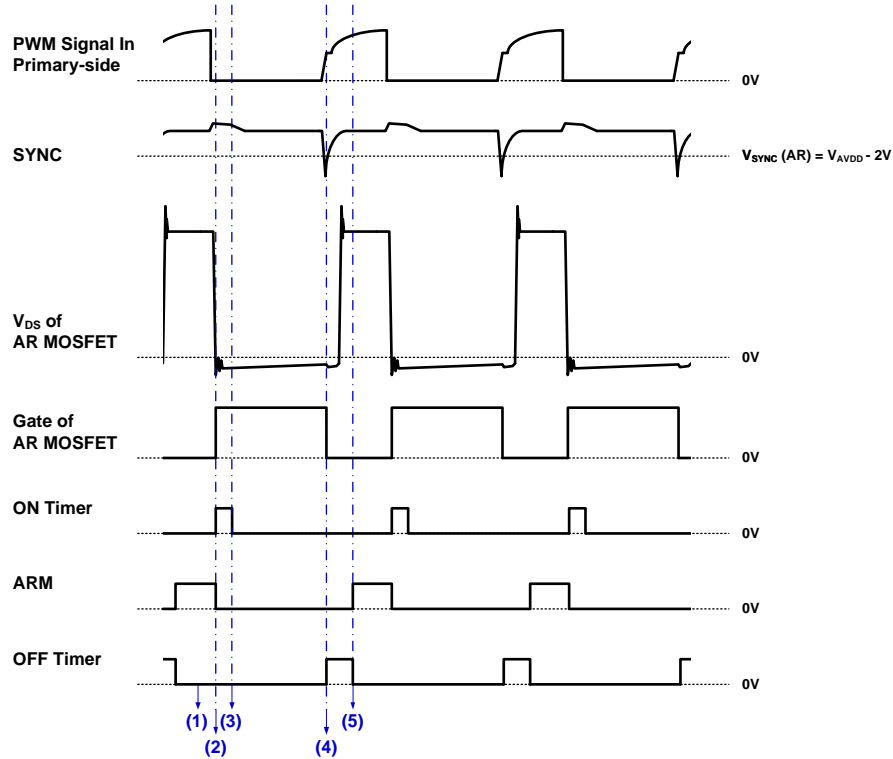

Steps of Operation

- (1) At the logic 'H' of the internal signal ARM, the voltage level of V_{DS} shall be checked continuously. At this time, no current shall flow through the embedded MOSFET (neither its body-diode).
- (2) When the primary-side controller stops conducting, the transfer of energy to the secondary-side commences. At this time, the current flowing through the body-diode of embedded MOSFET shall rise rapidly. When $V_{DS} \leq V_{THON}$ (-130mV typical), the embedded MOSFET is turned ON, the T_{ON} timer starts decrementing, and the ARM signal is reset. Before the T_{ON} timer expires, the embedded MOSFET shall remain ON.
- (3) Now, the T_{ON} timer expires. If V_{DS} is still lower than V_{THOFF} , the embedded MOSFET shall remain ON.
- (4) In contrast to the operation under DCM, the current flowing through the embedded MOSFET never falls to zero. As a result, the voltage level of V_{DS} can never reach the V_{THOFF} (-4mV typical). Therefore, unlike in the case of the DCM operation, the embedded MOSFET shall remain ON until the primary-side controller starts conducting. To avoid any possibility of shoot-through, the embedded MOSFET is turned OFF as soon as the condition [$V_{SYNC} < (V_{AVDD} - 2V)$] becomes true. When the embedded MOSFET is turned OFF, the remaining energy starts to flow through the body-diode. This creates a voltage drop far smaller than V_{THON} . Therefore, the T_{ON} timer is activated to prevent the embedded MOSFET from being turned ON.
- (5) After the T_{OFF} timer expires, the level of the ARM signal shall be checked continuously. As soon as it goes 'H', the voltage level of V_{DS} is checked and step #1 repeats.

Ordering Information (Note 8)

Note: 8. For packaging details, please visit our website at <http://www.diodes.com/products/packages.html>.

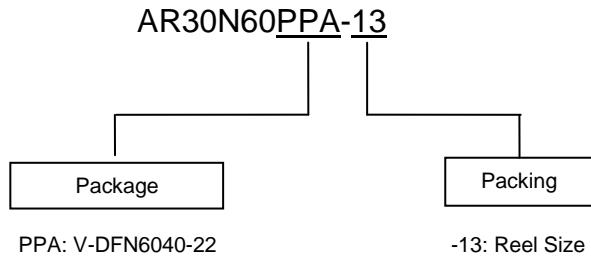

Product	Marking	Reel Size (inches)	Tape Width (mm)	13" Tape and Reel	
				Quantity	Part Number Suffix
AR30N60PPA-13	AR30N60	13	12	3,000/Tape & Reel	-13

Marking Information

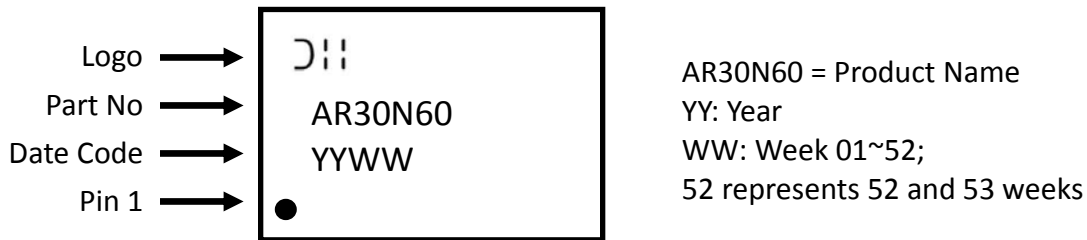

Package Outline Dimensions (All dimensions in mm.)

Please see <http://www.diodes.com/package-outlines.html> for the latest version.

V-DFN6040-22

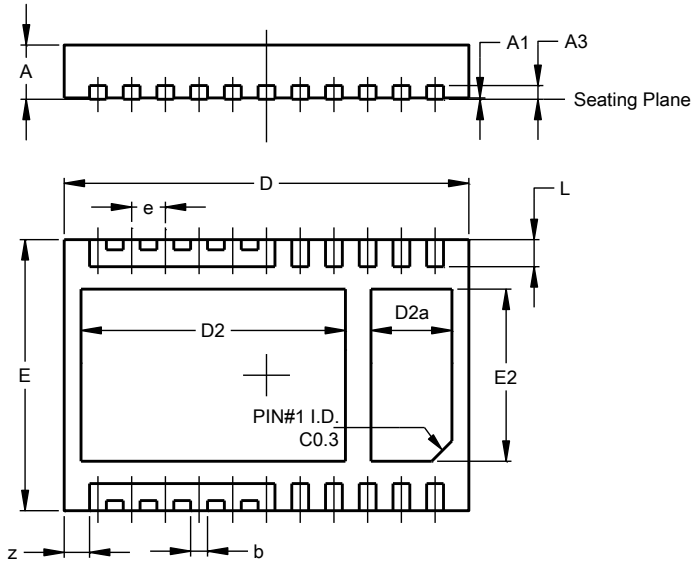

V-DFN6040-22			
Dim	Min	Max	Typ
A	0.75	0.85	0.80
A1	0.00	0.05	0.02
A3	0.203 BSC		
b	0.20	0.30	0.25
D	5.95	6.05	6.00
D2	3.82	4.02	3.92
D2a	1.10	1.30	1.20
E	3.95	4.05	4.00
E2	2.44	2.64	2.54
e	0.50 BSC		
L	0.35	0.45	0.40
z	0.375 TYP		
All Dimensions in mm			

Suggested Pad Layout

Please see <http://www.diodes.com/package-outlines.html> for the latest version.

V-DFN6040-22

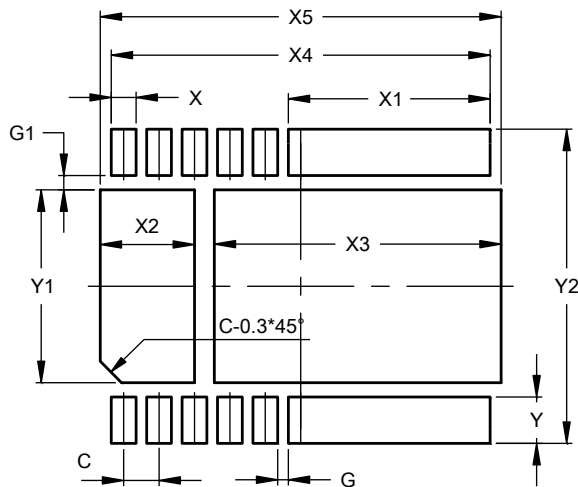

Dimensions	Value (in mm)
C	0.500
G	0.150
G1	0.200
X	0.350
X1	2.850
X2	1.330
X3	4.050
X4	5.350
X5	5.660
Y	0.650
Y1	2.700
Y2	4.400

IMPORTANT NOTICE

DIODES INCORPORATED MAKES NO WARRANTY OF ANY KIND, EXPRESS OR IMPLIED, WITH REGARDS TO THIS DOCUMENT, INCLUDING, BUT NOT LIMITED TO, THE IMPLIED WARRANTIES OF MERCHANTABILITY AND FITNESS FOR A PARTICULAR PURPOSE (AND THEIR EQUIVALENTS UNDER THE LAWS OF ANY JURISDICTION).

Diodes Incorporated and its subsidiaries reserve the right to make modifications, enhancements, improvements, corrections or other changes without further notice to this document and any product described herein. Diodes Incorporated does not assume any liability arising out of the application or use of this document or any product described herein; neither does Diodes Incorporated convey any license under its patent or trademark rights, nor the rights of others. Any Customer or user of this document or products described herein in such applications shall assume all risks of such use and will agree to hold Diodes Incorporated and all the companies whose products are represented on Diodes Incorporated website, harmless against all damages.

Diodes Incorporated does not warrant or accept any liability whatsoever in respect of any products purchased through unauthorized sales channel.

Should Customers purchase or use Diodes Incorporated products for any unintended or unauthorized application, Customers shall indemnify and hold Diodes Incorporated and its representatives harmless against all claims, damages, expenses, and attorney fees arising out of, directly or indirectly, any claim of personal injury or death associated with such unintended or unauthorized application.

Products described herein may be covered by one or more United States, international or foreign patents pending. Product names and markings noted herein may also be covered by one or more United States, international or foreign trademarks.

This document is written in English but may be translated into multiple languages for reference. Only the English version of this document is the final and determinative format released by Diodes Incorporated.

LIFE SUPPORT

Diodes Incorporated products are specifically not authorized for use as critical components in life support devices or systems without the express written approval of the Chief Executive Officer of Diodes Incorporated. As used herein:

A. Life support devices or systems are devices or systems which:

1. are intended to implant into the body, or
2. support or sustain life and whose failure to perform when properly used in accordance with instructions for use provided in the labeling can be reasonably expected to result in significant injury to the user.

B. A critical component is any component in a life support device or system whose failure to perform can be reasonably expected to cause the failure of the life support device or to affect its safety or effectiveness.

Customers represent that they have all necessary expertise in the safety and regulatory ramifications of their life support devices or systems, and acknowledge and agree that they are solely responsible for all legal, regulatory and safety-related requirements concerning their products and any use of Diodes Incorporated products in such safety-critical, life support devices or systems, notwithstanding any devices- or systems-related information or support that may be provided by Diodes Incorporated. Further, Customers must fully indemnify Diodes Incorporated and its representatives against any damages arising out of the use of Diodes Incorporated products in such safety-critical, life support devices or systems.

Copyright © 2016, Diodes Incorporated

www.diodes.com