



POSEICO SPA  
POwer SEMiconductors Italian COrporation

POSEICO SPA  
Via N. Lorenzi 8, 16152 Genova - ITALY  
Tel. ++ 39 010 6556234 - Fax ++ 39 010 6557519  
Sales Office:  
Tel. ++ 39 010 6556775 - Fax ++ 39 010 6442510

## RECTIFIER DIODE

# AR749LT

Repetitive voltage up to **2500 V**  
Mean forward current **5180 A**  
Surge current **70 kA**

### FINAL SPECIFICATION

nov 02 - ISSUE : 02

Symbol	Characteristic	Conditions	T <sub>j</sub> [°C]	Value	Unit
<b>BLOCKING</b>					
V <sub>RRM</sub>	Repetitive peak reverse voltage		175	2500	V
V <sub>RSM</sub>	Non-repetitive peak reverse voltage		175	2600	V
I <sub>RRM</sub>	Repetitive peak reverse current	V=VRRM	175	150	mA
<b>CONDUCTING</b>					
I <sub>F(AV)</sub>	Mean forward current	180° sin ,50 Hz, Th=55°C, double side cooled		5180	A
I <sub>F(AV)</sub>	Mean forward current	180° sin ,50 Hz, Tc=85°C, double side cooled		5030	A
I <sub>FSM</sub>	Surge forward current	Sine wave, 10 ms without reverse voltage	175	70	kA
I <sup>2</sup> t	I <sup>2</sup> t			24500 x 1E3	A <sup>2</sup> s
V <sub>FM</sub>	Forward voltage	Forward current = 3000 A	25	1.30	V
V <sub>F(TO)</sub>	Threshold voltage		175	0.65	V
r <sub>F</sub>	Forward slope resistance		175	0.140	mohm
<b>SWITCHING</b>					
t <sub>rr</sub>	Reverse recovery time		175		μs
Q <sub>rr</sub>	Reverse recovery charge				μC
I <sub>rr</sub>	Peak reverse recovery current				A
<b>MOUNTING</b>					
R <sub>th(j-h)</sub>	Thermal impedance, DC	Junction to heatsink, double side cooled		9.5	°C/kW
R <sub>th(c-h)</sub>	Thermal impedance	Case to heatsink, double side cooled		2	°C/kW
T <sub>j</sub>	Operating junction temperature			-30 / 175	°C
F	Mounting force			46.0 / 54.0	kN
	Mass			1150	g

### ORDERING INFORMATION : AR749LT S 25

standard specification   VRRM/100

## DISSIPATION CHARACTERISTICS

### SQUARE WAVE

Th [°C]

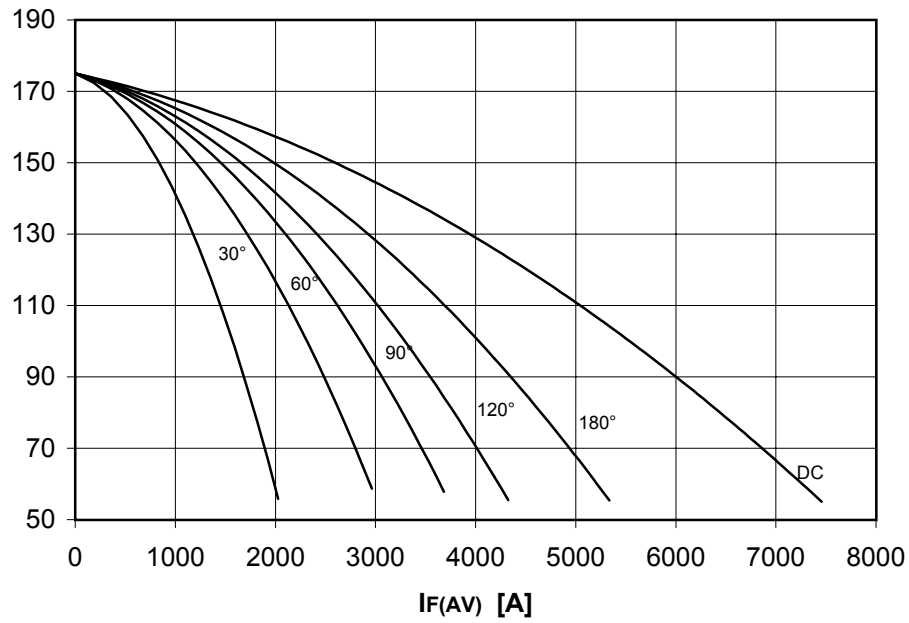

PF(AV) [W]

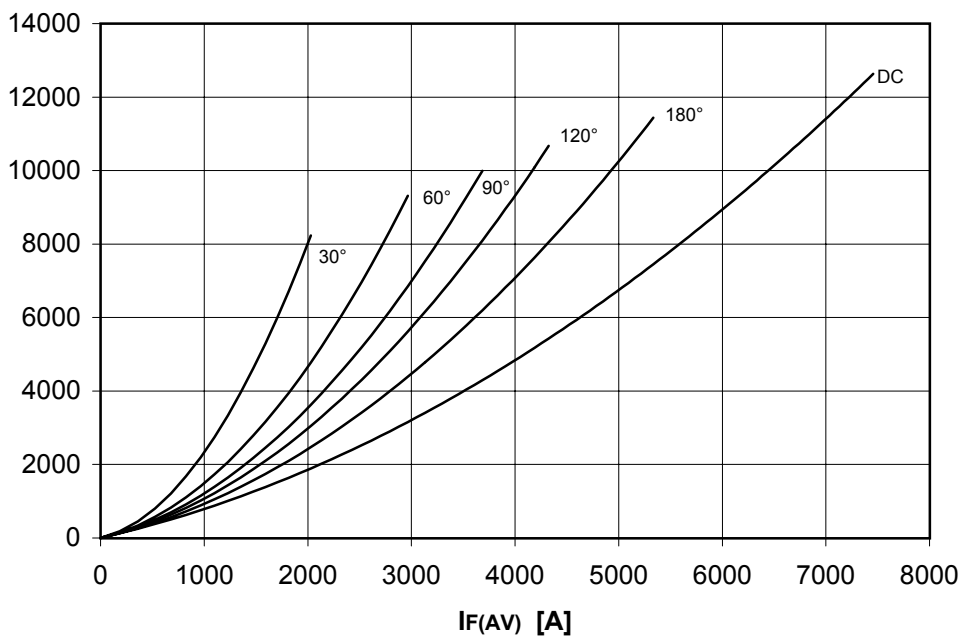

## DISSIPATION CHARACTERISTICS

SINE WAVE

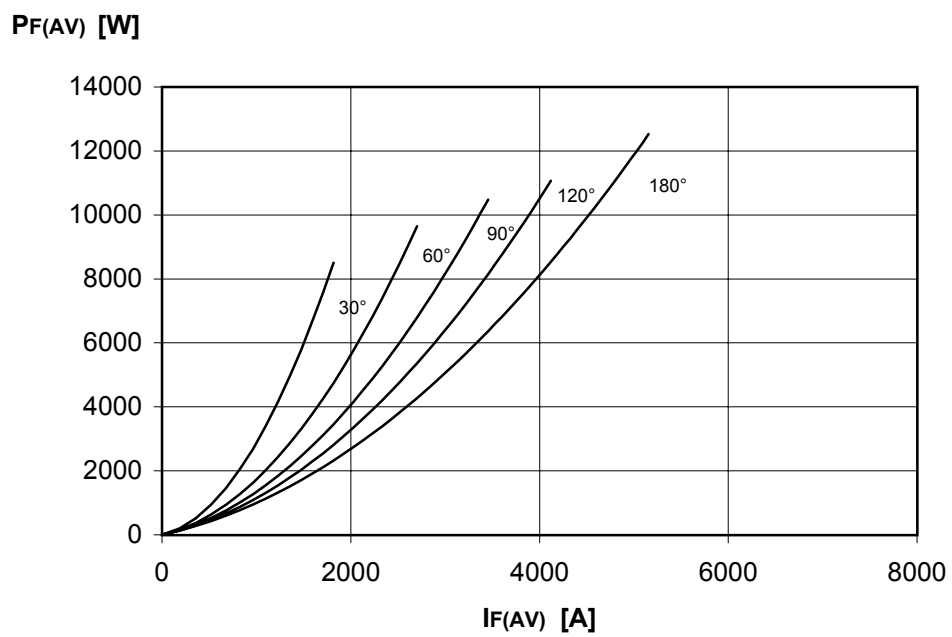
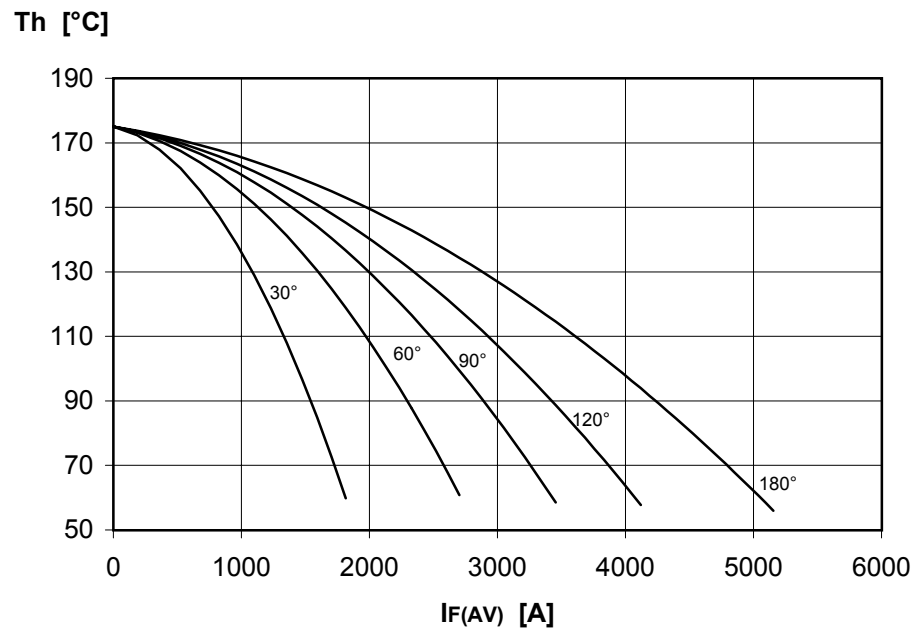

# AR749LT RECTIFIER DIODE

FINAL SPECIFICATION nov 02 - ISSUE : 02

FORWARD CHARACTERISTIC  
T<sub>j</sub> = 175 °C

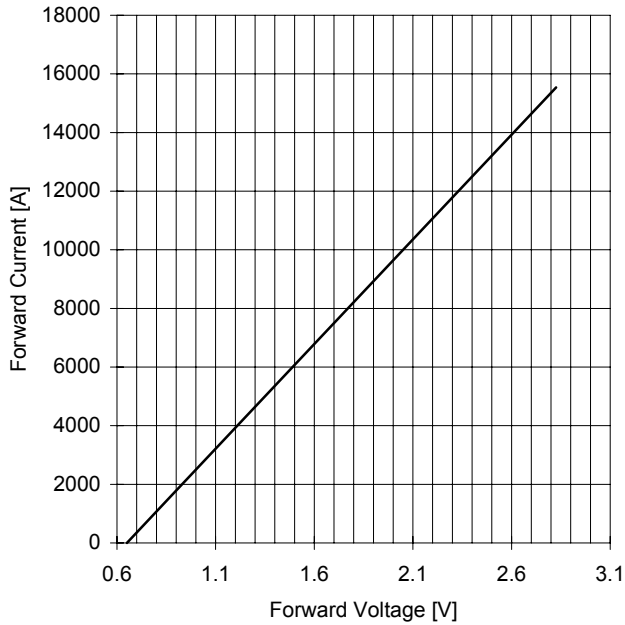

SURGE CHARACTERISTIC  
T<sub>j</sub> = 175 °C

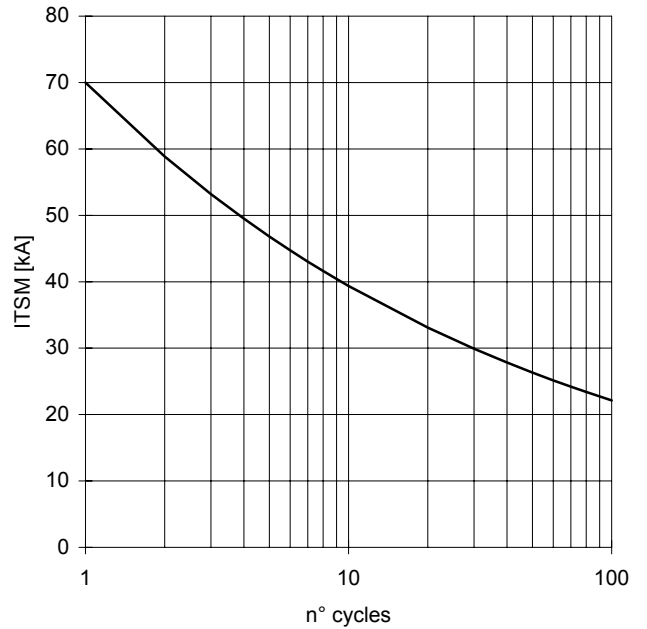

TRANSIENT THERMAL IMPEDANCE  
DOUBLE SIDE COOLED

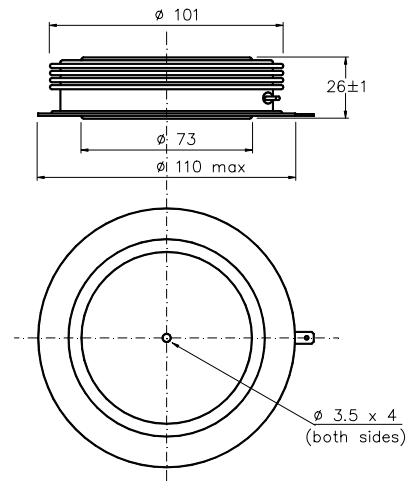
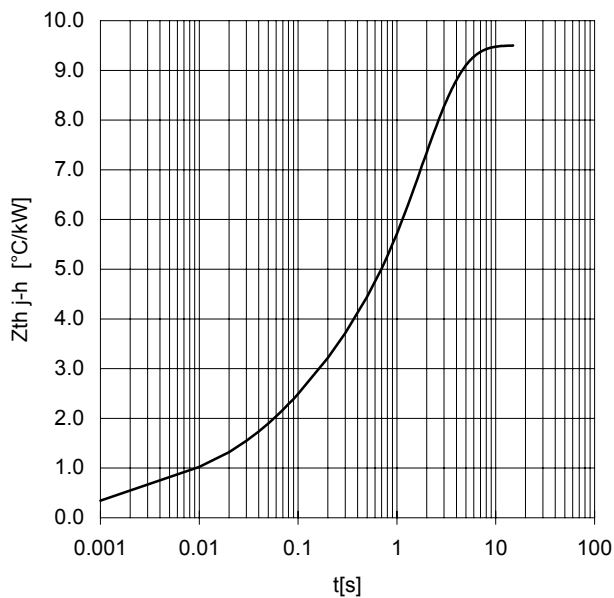

Dimensions  
in mm

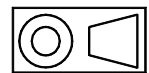

All the characteristics given in this data sheet are guaranteed only with uniform clamping force, cleaned and lubricated heatsink, surfaces with flatness < .03 mm and roughness < 2 μm.

In the interest of product improvement POSEICO reserves the right to change any data given in this data sheet at any time without previous notice.

If not stated otherwise the maximum value of ratings (symbols over shaded background) and characteristics is reported.

Distributed by

