



POSEICO SPA  
Power SEMiconductors Italian COrporation

POSEICO SPA  
Via N. Lorenzi 8, 16152 Genova - ITALY  
Tel. ++ 39 010 6556234 - Fax ++ 39 010 6557519  
Sales Office:  
Tel. ++ 39 010 6556775 - Fax ++ 39 010 6442510

**RECTIFIER DIODE**

**AR770HT**

Repetitive voltage up to **4500 V**  
Mean forward current **3870 A**  
Surge current **50 kA**

**FINAL SPECIFICATION**

Iug 02 - ISSUE : 02

Symbol	Characteristic	Conditions	Tj [°C]	Value	Unit
<b>BLOCKING</b>					
V <sub>RRM</sub>	Repetitive peak reverse voltage		150	4500	V
V <sub>RSM</sub>	Non-repetitive peak reverse voltage		150	4600	V
I <sub>RRM</sub>	Repetitive peak reverse current	V=VRRM	150	200	mA
<b>CONDUCTING</b>					
I <sub>F(AV)</sub>	Mean forward current	180° sin ,50 Hz, Th=55°C, double side cooled		3870	A
I <sub>F(AV)</sub>	Mean forward current	180° sin ,50 Hz, Tc=85°C, double side cooled		3465	A
I <sub>FSM</sub>	Surge forward current	Sine wave, 10 ms without reverse voltage	150	50	kA
I <sup>2</sup> t	I <sup>2</sup> t			12500 x 1E3	A <sup>2</sup> s
V <sub>FM</sub>	Forward voltage	Forward current = 3000 A	25	1,28	V
V <sub>F(TO)</sub>	Threshold voltage		150	0,80	V
r <sub>F</sub>	Forward slope resistance		150	0,150	mohm
<b>SWITCHING</b>					
t <sub>rr</sub>	Reverse recovery time	I= 1600 A			µs
Q <sub>rr</sub>	Reverse recovery charge	di/dt= 2A/µs	150	3500	µC
I <sub>rr</sub>	Peak reverse recovery current				A
<b>MOUNTING</b>					
R <sub>th(j-h)</sub>	Thermal impedance, DC	Junction to heatsink, double side cooled		11	°C/kW
R <sub>th(c-h)</sub>	Thermal impedance	Case to heatsink, double side cooled		2	°C/kW
T <sub>j</sub>	Operating junction temperature			-30 / 150	°C
F	Mounting force			46.0 / 54.0	kN
	Mass			1700	g

**ORDERING INFORMATION : AR770HT S 45**

standard specification   VRRM/100

## DISSIPATION CHARACTERISTICS

SQUARE WAVE

Th [°C]

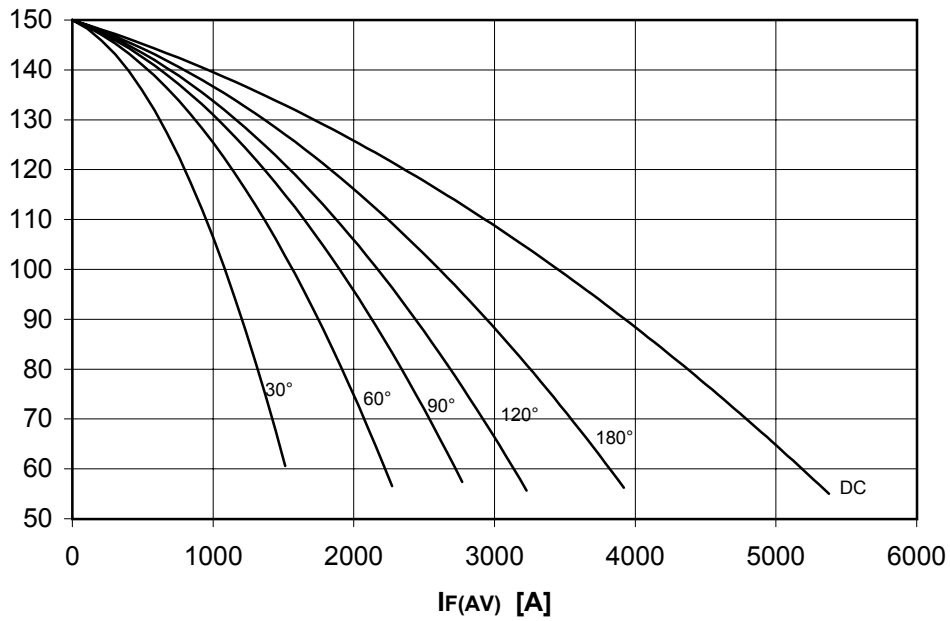

PF(AV) [W]

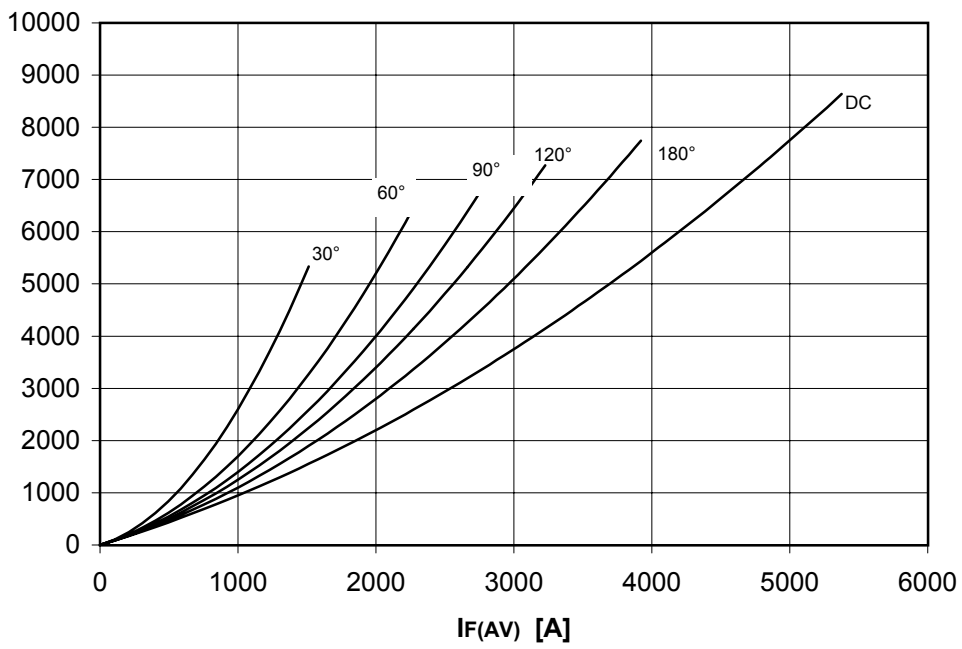

## DISSIPATION CHARACTERISTICS

SINE WAVE

Th [°C]

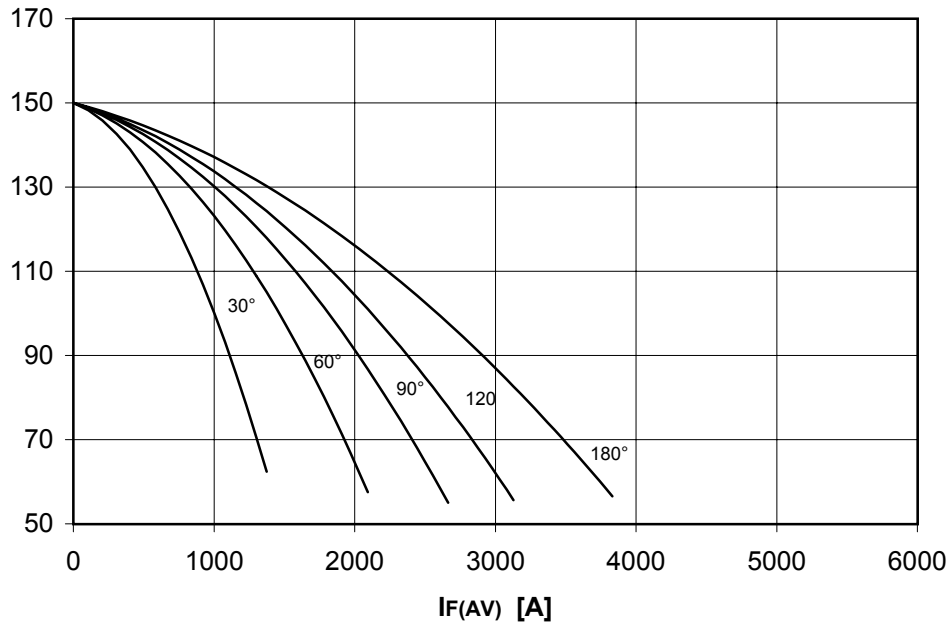

PF(AV) [W]

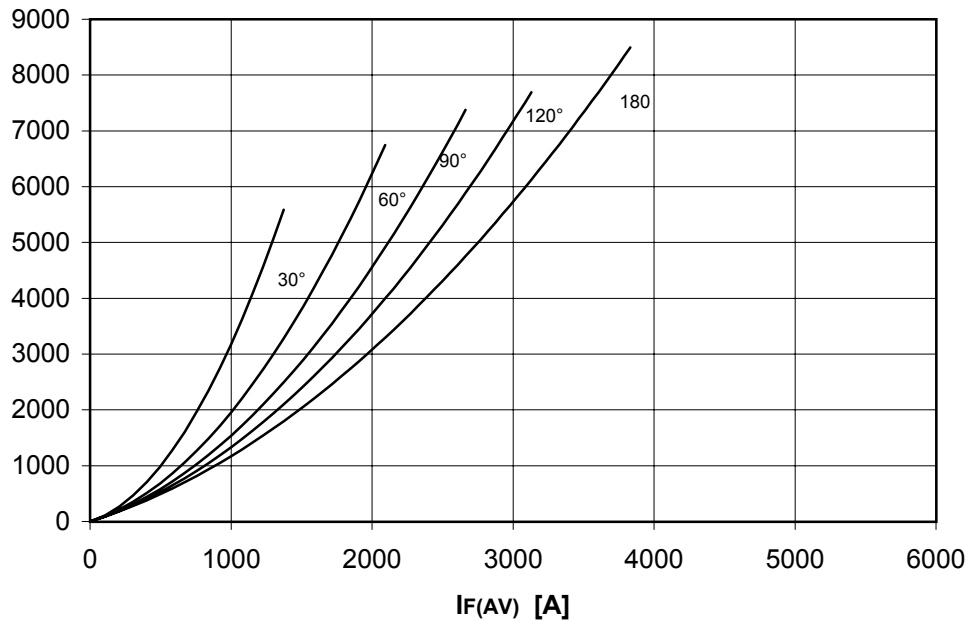

# AR770HT RECTIFIER DIODE

FINAL SPECIFICATION Iug 02 - ISSUE : 02

FORWARD CHARACTERISTIC  
 $T_j = 150\text{ }^\circ\text{C}$

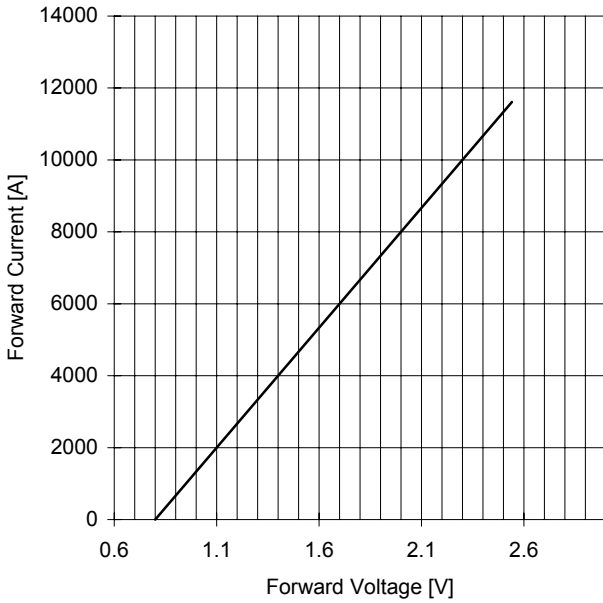

SURGE CHARACTERISTIC  
 $T_j = 150\text{ }^\circ\text{C}$

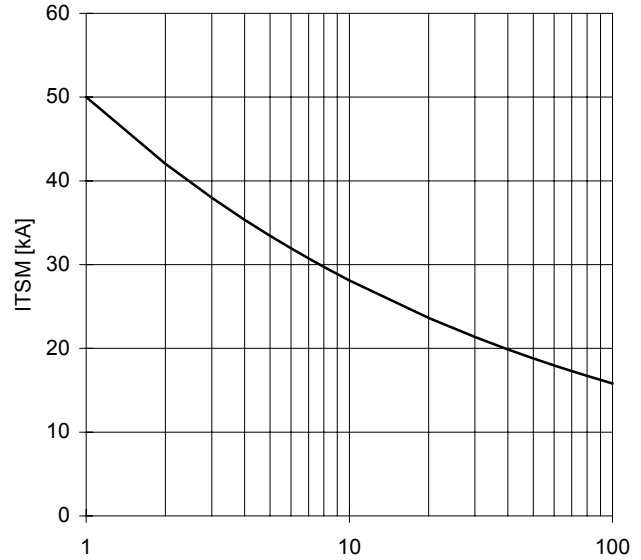

TRANSIENT THERMAL IMPEDANCE  
 DOUBLE SIDE COOLED

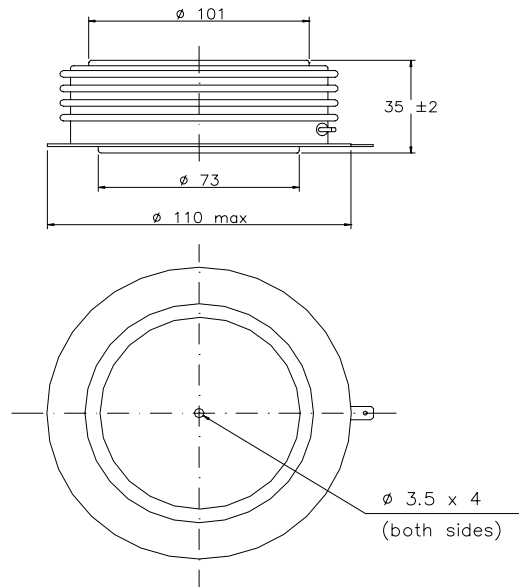
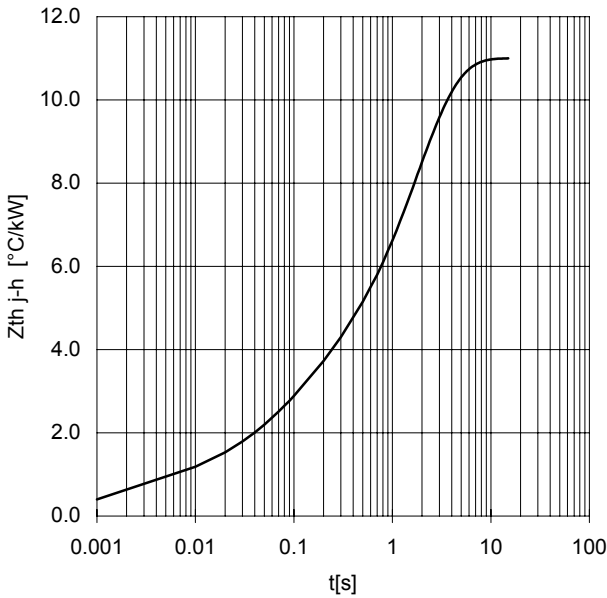

Dimensions  
in mm



All the characteristics given in this data sheet are guaranteed only with uniform clamping force, cleaned and lubricated heatsink, surfaces with flatness < .03 mm and roughness < 2  $\mu\text{m}$ .

In the interest of product improvement POSEICO reserves the right to change any data given in this data sheet at any time without previous notice.

If not stated otherwise the maximum value of ratings (symbols over shaded background) and characteristics is reported.

Distributed by

