



POSEICO SPA
Power SEMiconductors Italian COrporation

POSEICO SPA
Via N. Lorenzi 8, 16152 Genova - ITALY
Tel. ++ 39 010 6556234 - Fax ++ 39 010 6557519
Sales Office:
Tel. ++ 39 010 6556775 - Fax ++ 39 010 6442510

RECTIFIER DIODE

AR771HT

Repetitive voltage up to **4500 V**
Mean forward current **3680 A**
Surge current **50 kA**

FINAL SPECIFICATION

Iug 02 - ISSUE : 02

Symbol	Characteristic	Conditions	Tj [°C]	Value	Unit
BLOCKING					
V _{RRM}	Repetitive peak reverse voltage		150	4500	V
V _{RSM}	Non-repetitive peak reverse voltage		150	4600	V
I _{RRM}	Repetitive peak reverse current	V=VRRM	150	200	mA
CONDUCTING					
I _{F(AV)}	Mean forward current	180° sin ,50 Hz, Th=55°C, double side cooled		3680	A
I _{F(AV)}	Mean forward current	180° sin ,50 Hz, Tc=85°C, double side cooled		3300	A
I _{FSM}	Surge forward current	Sine wave, 10 ms without reverse voltage	150	50	kA
I ² t	I ² t			12500 x 1E3	A ² s
V _{FM}	Forward voltage	Forward current = 3000 A	25	1.28	V
V _{F(TO)}	Threshold voltage		150	0.80	V
r _F	Forward slope resistance		150	0.170	mohm
SWITCHING					
t _{rr}	Reverse recovery time	I= 1600 A			µs
Q _{rr}	Reverse recovery charge	di/dt= 2A/µs	150	3500	µC
I _{rr}	Peak reverse recovery current				A
MOUNTING					
R _{th(j-h)}	Thermal impedance, DC	Junction to heatsink, double side cooled		11	°C/kW
R _{th(c-h)}	Thermal impedance	Case to heatsink, double side cooled		2	°C/kW
T _j	Operating junction temperature			-30 / 150	°C
F	Mounting force			46.0 / 54.0	kN
	Mass			1700	g

ORDERING INFORMATION : AR771HT S 45

standard specification VRRM/100

DISSIPATION CHARACTERISTICS

SQUARE WAVE

Th [°C]

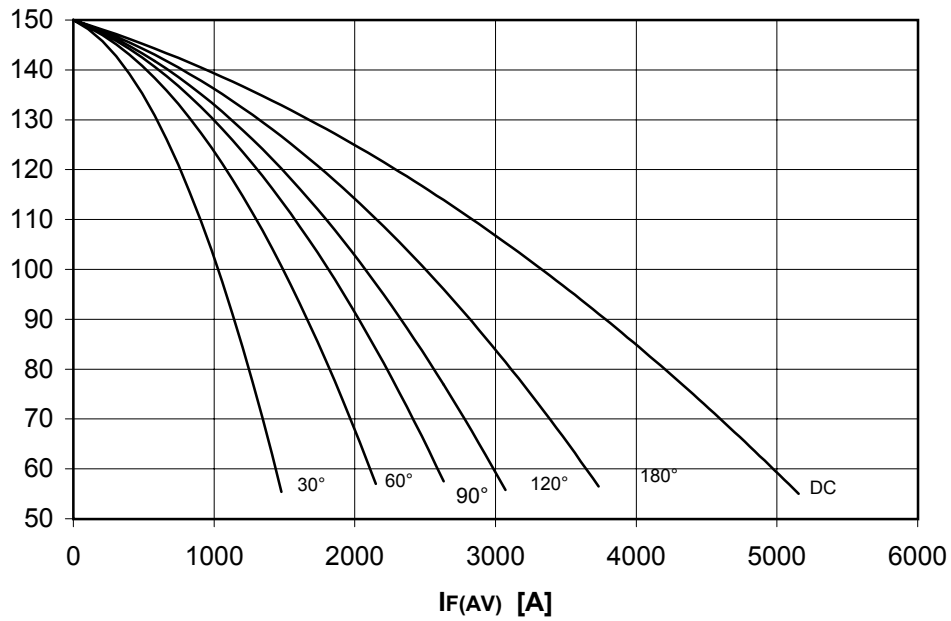

PF(AV) [W]

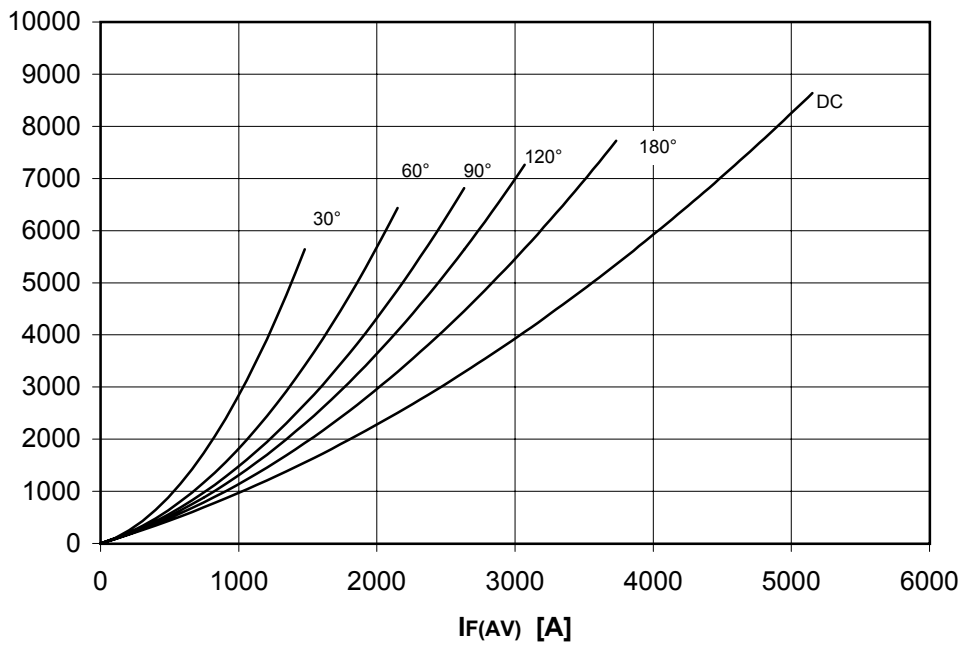

DISSIPATION CHARACTERISTICS

SINE WAVE

Th [°C]

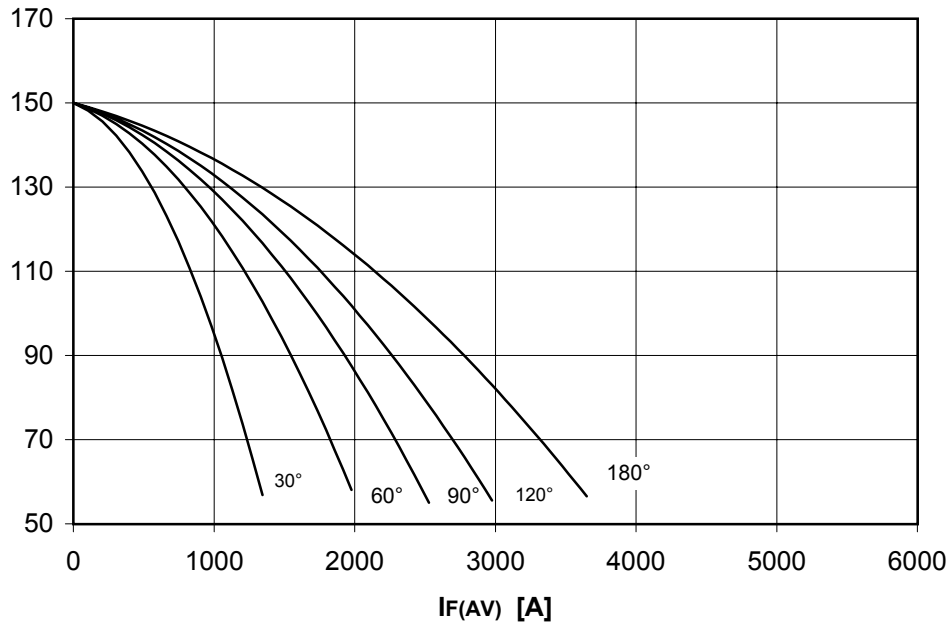

PF(AV) [W]

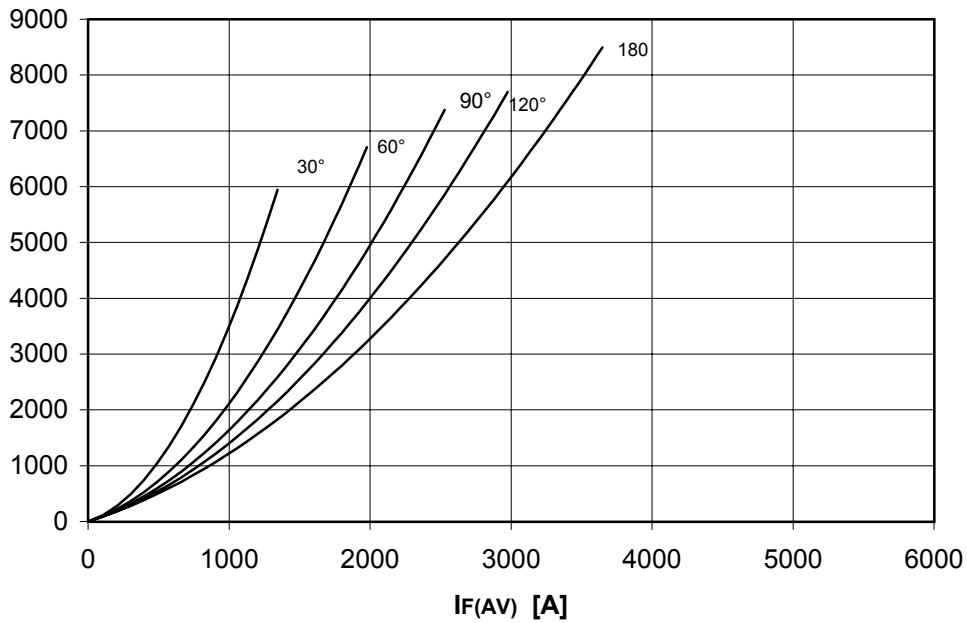

AR771HT RECTIFIER DIODE

FINAL SPECIFICATION lug 02 - ISSUE : 02

FORWARD CHARACTERISTIC
 $T_j = 150\text{ }^\circ\text{C}$

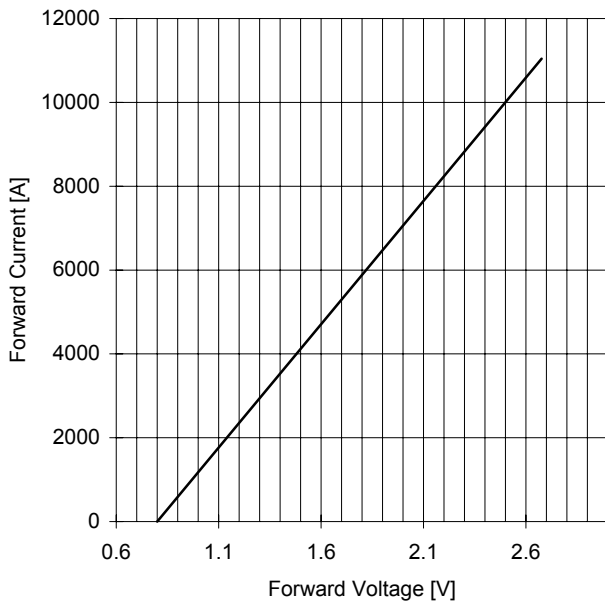

SURGE CHARACTERISTIC
 $T_j = 150\text{ }^\circ\text{C}$

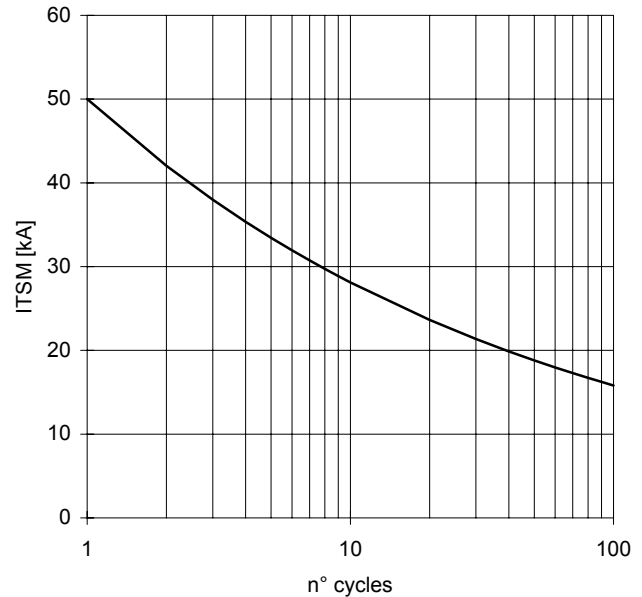

TRANSIENT THERMAL IMPEDANCE
DOUBLE SIDE COOLED

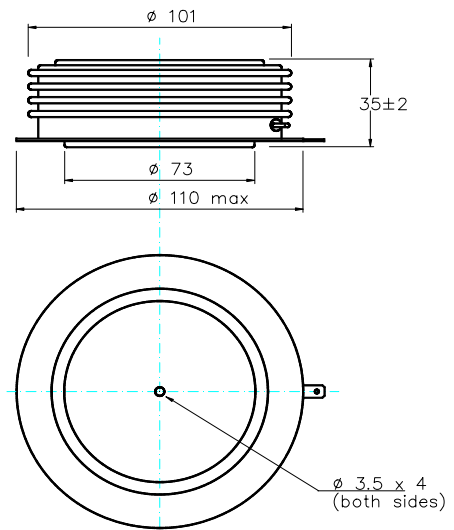
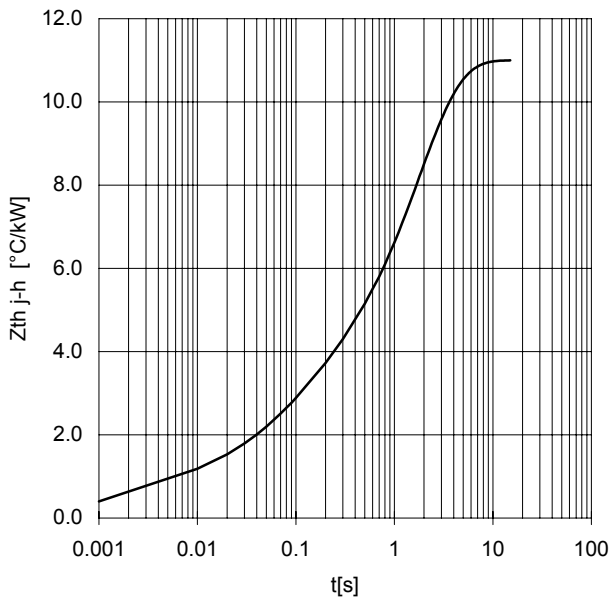

Dimensions
in mm



All the characteristics given in this data sheet are guaranteed only with uniform clamping force, cleaned and lubricated heatsink, surfaces with flatness $< .03\text{ }\mu\text{m}$ and roughness $< 2\text{ }\mu\text{m}$.
In the interest of product improvement POSEICO reserves the right to change any data given in this data sheet at any time without previous notice.
If not stated otherwise the maximum value of ratings (symbols over shaded background) and characteristics is reported.

Distributed by

