



POSEICO SPA
POwer SEMiconductors Italian Corporation

POSEICO SPA
Via N. Lorenzi 8, 16152 Genova - ITALY
Tel. ++ 39 010 6556234 - Fax ++ 39 010 6557519
Sales Office:
Tel. ++ 39 010 6556775 - Fax ++ 39 010 6442510

RECTIFIER DIODE

AR912

Repetitive voltage up to **5600 V**
Mean forward current **645 A**
Surge current **6.3 kA**

FINAL SPECIFICATION

nov 02 - ISSUE : 05

Symbol	Characteristic	Conditions	T _j [°C]	Value	Unit
BLOCKING					
V _{RRM}	Repetitive peak reverse voltage		150	5600	V
V _{RSM}	Non-repetitive peak reverse voltage		150	5700	V
I _{RRM}	Repetitive peak reverse current	V=VRRM	150	50	mA
CONDUCTING					
I _{F(AV)}	Mean forward current	180° sin ,50 Hz, Th=55°C, double side cooled		645	A
I _{F(AV)}	Mean forward current	180° sin ,50 Hz, Tc=85°C, double side cooled		580	A
I _{FSM}	Surge forward current	Sine wave, 10 ms without reverse voltage	150	6.3	kA
I ² t	I ² t			198 x 1E3	A ² s
V _{FM}	Forward voltage	Forward current = 1200 A	25	2.10	V
V _{F(TO)}	Threshold voltage		150	1.00	V
r _F	Forward slope resistance		150	1.150	mohm
SWITCHING					
t _{rr}	Reverse recovery time				μs
Q _{rr}	Reverse recovery charge		150		μC
I _{rr}	Peak reverse recovery current				A
MOUNTING					
R _{th(j-h)}	Thermal impedance, DC	Junction to heatsink, double side cooled		52	°C/kW
R _{th(c-h)}	Thermal impedance	Case to heatsink, double side cooled		10	°C/kW
T _j	Operating junction temperature			-30 / 150	°C
F	Mounting force			8.4 / 9.4	kN
	Mass			280	g

ORDERING INFORMATION : AR912 S 56

standard specification VRRM/100

DISSIPATION CHARACTERISTICS

SQUARE WAVE

Th [°C]

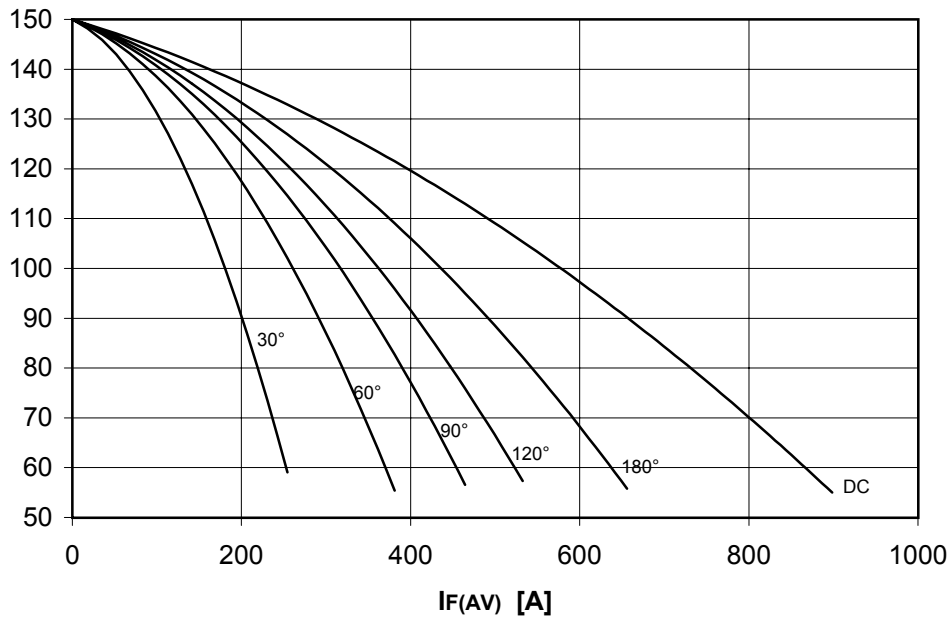

PF(AV) [W]

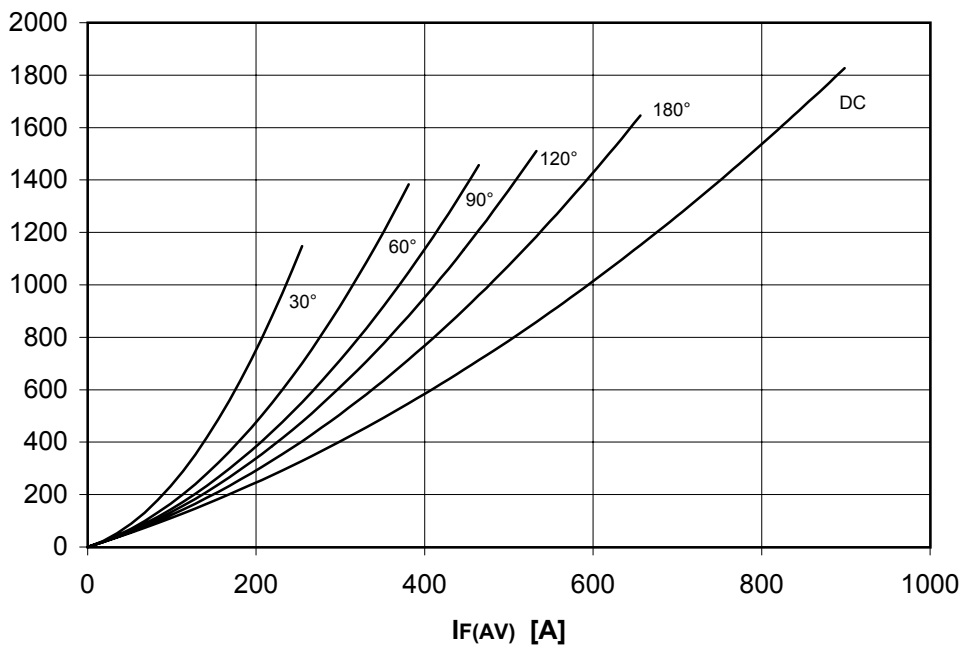

DISSIPATION CHARACTERISTICS

SINE WAVE

Th [°C]

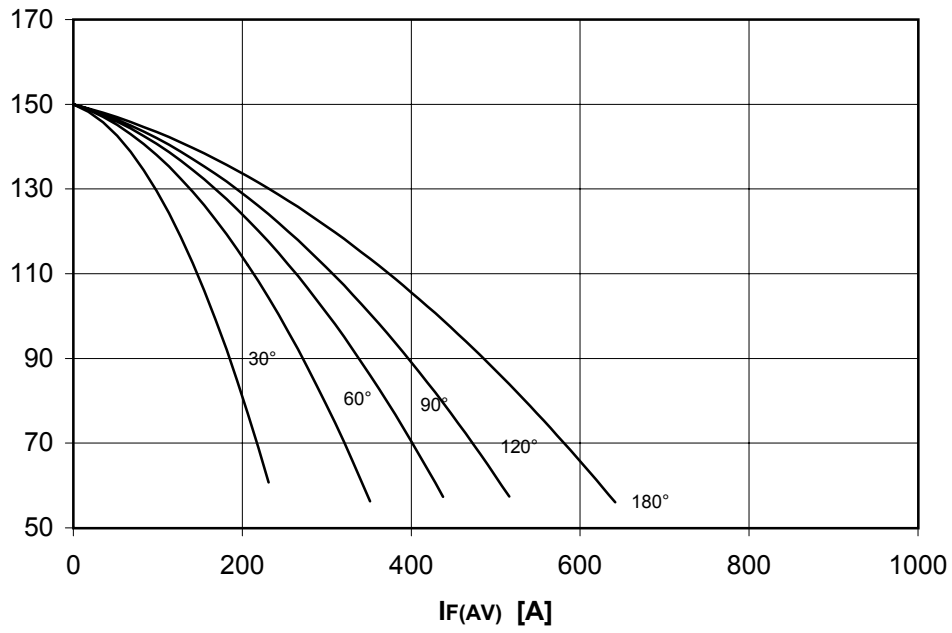

PF(AV) [W]

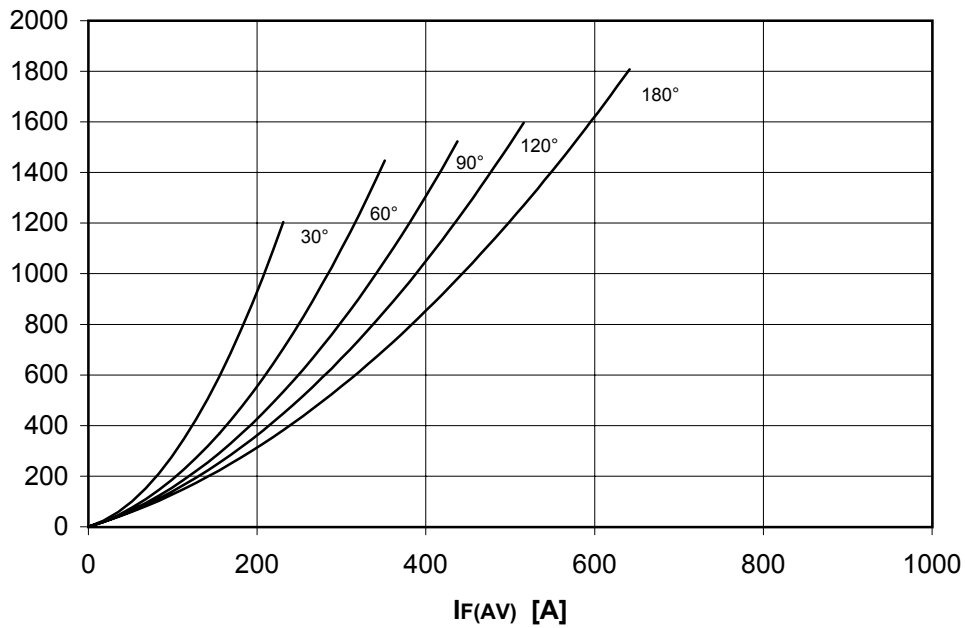

AR912 RECTIFIER DIODE

FINAL SPECIFICATION nov 02 - ISSUE : 05

FORWARD CHARACTERISTIC
 $T_j = 150\text{ }^\circ\text{C}$

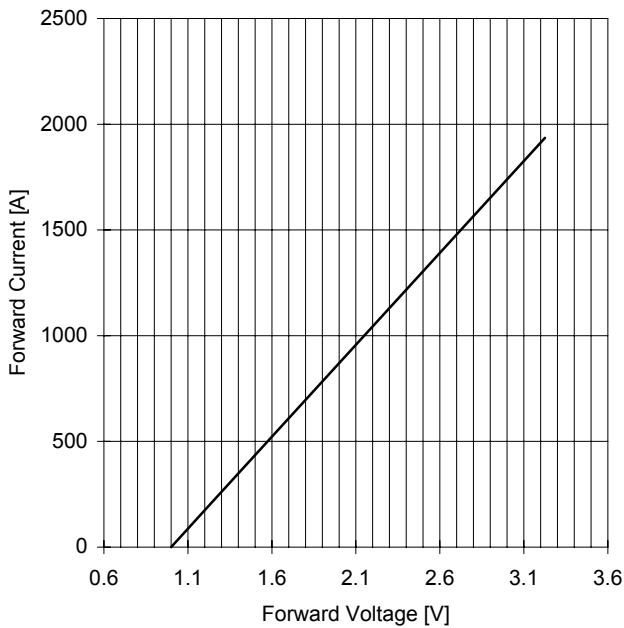

SURGE CHARACTERISTIC
 $T_j = 150\text{ }^\circ\text{C}$

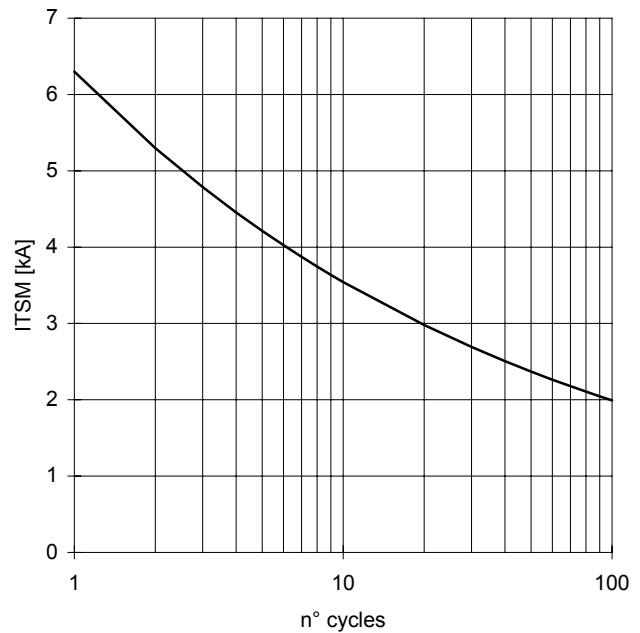

TRANSIENT THERMAL IMPEDANCE
DOUBLE SIDE COOLED

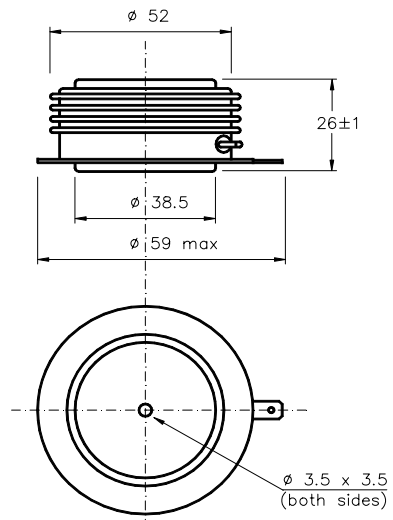
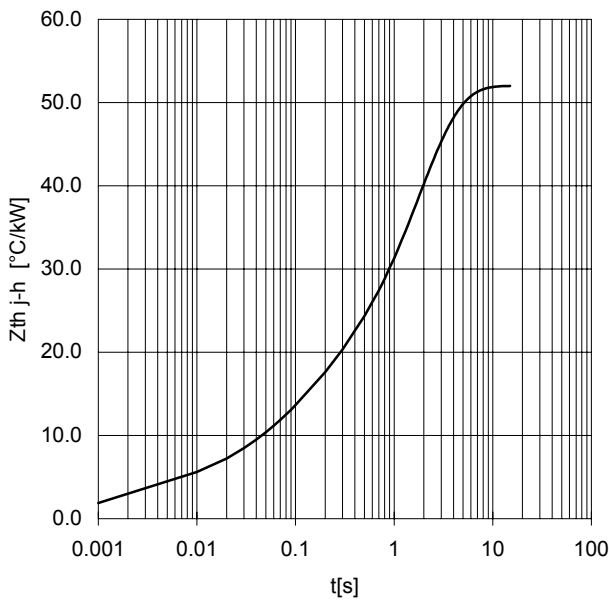

Dimensions
in mm



All the characteristics given in this data sheet are guaranteed only with uniform clamping force, cleaned and lubricated heatsink, surfaces with flatness < .03 mm and roughness < 2 μm .

In the interest of product improvement POSEICO SpA reserves the right to change any data given in this data sheet at any time without previous notice.

If not stated otherwise the maximum value of ratings (symbols over shaded background) and characteristics is reported.

Distributed by

