

**ANSALDO****Ansaldo Trasporti s.p.a.**  
**Unita' Semiconduttori**Via N. Lorenzi 8 - I 16152 GENOVA - ITALY  
Tel. int. +39/(0)10 6556549 - (0)10 6556488  
Fax Int. +39/(0)10 6442510  
Tx 270318 ANSUSE I -**FAST RECOVERY DIODE****ARF221**

Repetitive voltage up to	<b>1400 V</b>
Mean forward current	<b>415 A</b>
Surge current	<b>5 kA</b>

**FINAL SPECIFICATION**

ott 97 - ISSUE : 02

Symbol	Characteristic	Conditions	T <sub>j</sub> [°C]	Value	Unit
<b>BLOCKING</b>					
V <sub>RRM</sub>	Repetitive peak reverse voltage		125	1400	V
V <sub>RSM</sub>	Non-repetitive peak reverse voltage		125	1500	V
I <sub>RRM</sub>	Repetitive peak reverse current	V=VRRM	125	50	mA
<b>CONDUCTING</b>					
I <sub>F(AV)</sub>	Mean forward current	180° sin ,50 Hz, Th=55°C, double side cooled		415	A
I <sub>F(AV)</sub>	Mean forward current	180° square,50 Hz,Th=55°C,double side cooled		410	A
I <sub>FSM</sub>	Surge forward current	Sine wave, 10 ms	125	4.5	kA
I <sup>2</sup> t	I <sup>2</sup> t	reapplied reverse voltage up to 50% VRSM		101 x1E3	A <sup>2</sup> s
V <sub>FM</sub>	Forward voltage	Forward current : 600 A	125	1.47	V
V <sub>F(TO)</sub>	Threshold voltage		125	1.05	V
r <sub>F</sub>	Forward slope resistance		125	0.70	mohm
<b>SWITCHING</b>					
t <sub>rr</sub>	Reverse recovery time	I <sub>F</sub> = 200 A di/dt = 40 A/μs V <sub>R</sub> = 50 V	125	2.0	μs
Q <sub>rr</sub>	Reverse recovery charge			50	μC
I <sub>rr</sub>	Peak reverse recovery current			50	A
s	Softness (s-factor), min				
V <sub>FR</sub>	Peak forward recovery				V
<b>MOUNTING</b>					
R <sub>th(j-h)</sub>	Thermal impedance	Junction to heatsink, double side cooled		95	°C/kW
T <sub>j</sub>	Operating junction temperature			-30 / 125	°C
F	Mounting force			4.5 / 5.0	kN
	Mass			55	g

**ORDERING INFORMATION : ARF221 S 14**standard specification   VRRM/100

DISSIPATION CHARACTERISTICS

SQUARE WAVE

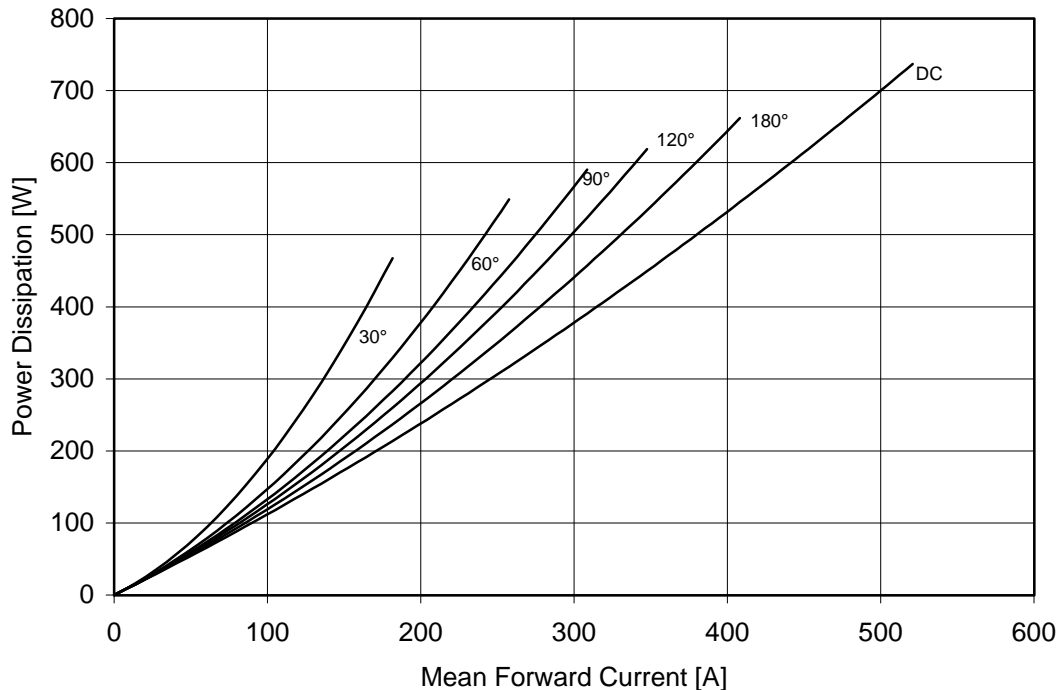

SINE WAVE

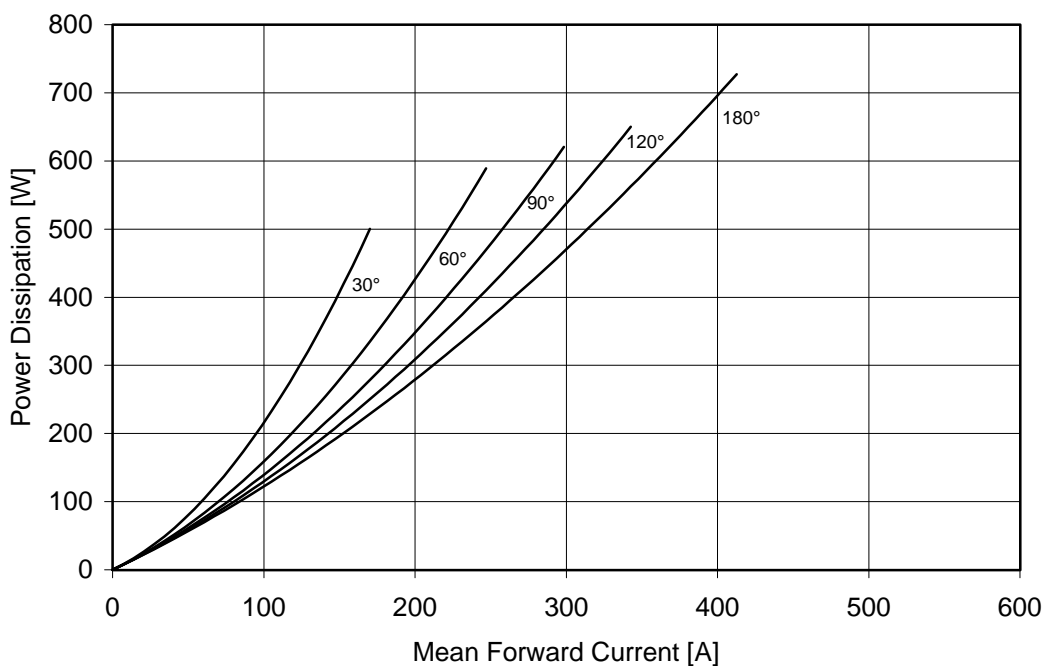

## SWITCHING CHARACTERISTICS

FORWARD RECOVERY VOLTAGE

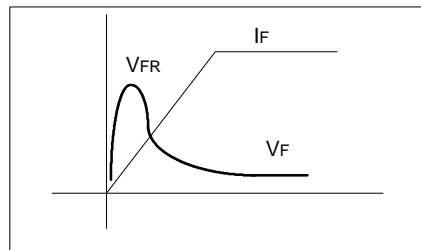
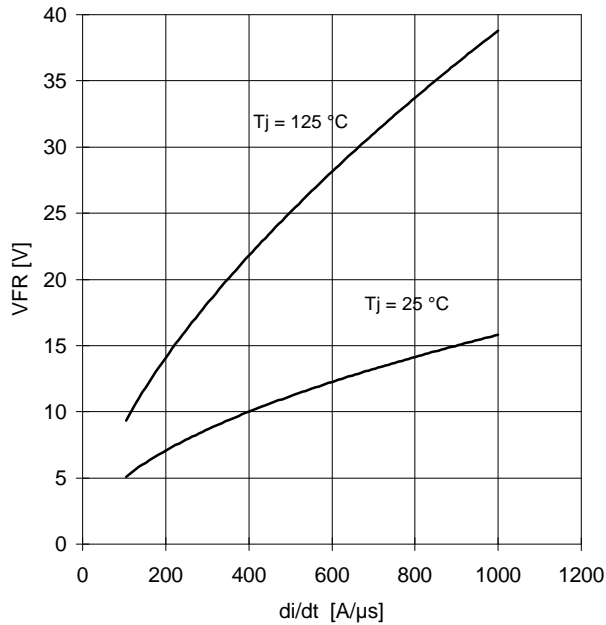

REVERSE RECOVERY CHARGE  
Tj = 125 °C

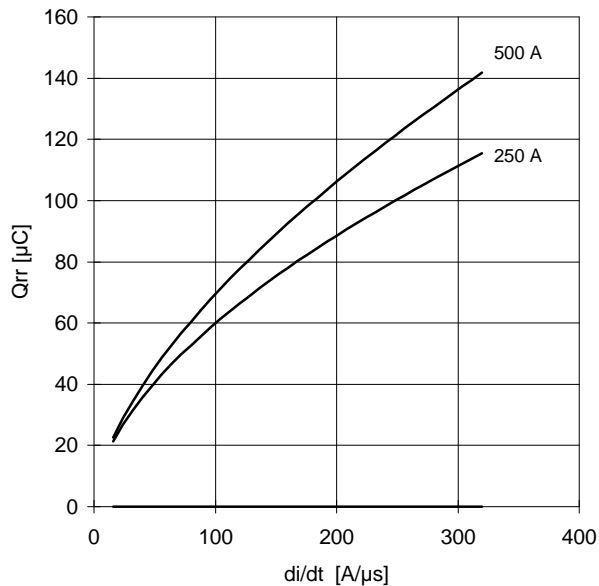

REVERSE RECOVERY CURRENT  
Tj = 125 °C

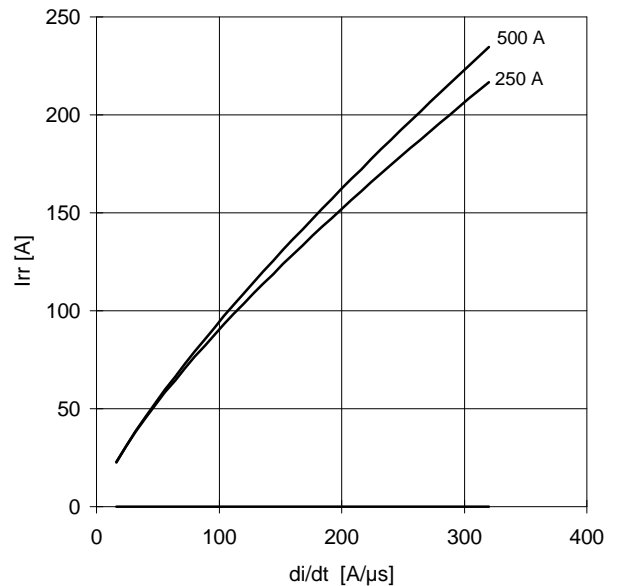

$$t_a = I_{rr} / (di/dt) \quad t_b = t_{rr} - t_a$$

$$\text{Softness (s factor)} \quad s = t_b / t_a$$

$$\text{Energy dissipation during recovery } E_r = V_r \cdot (Q_{rr} - I_{rr} \cdot t_a / 2)$$

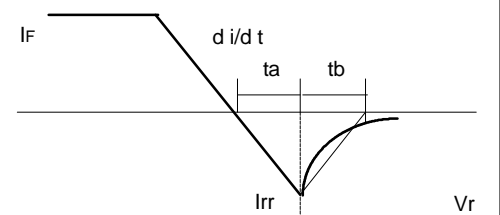

FORWARD CHARACTERISTIC  
T<sub>j</sub> = 125 °C

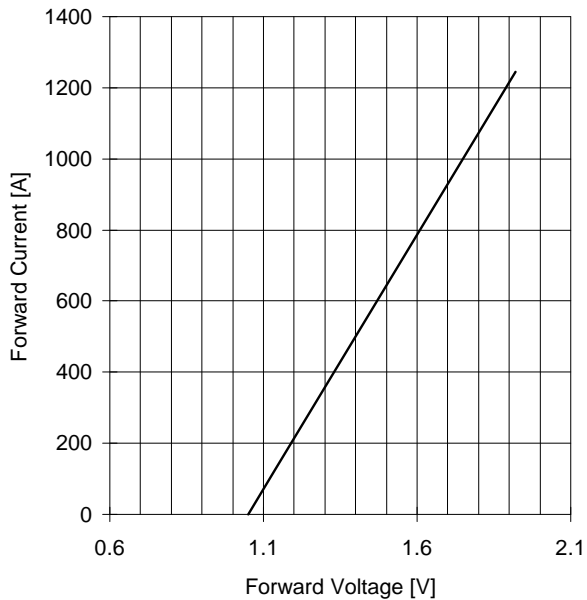

SURGE CHARACTERISTIC  
T<sub>j</sub> = 125 °C

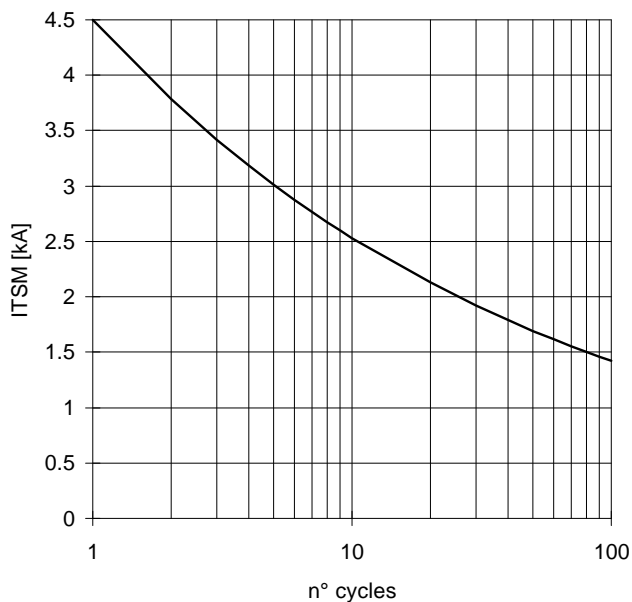

TRANSIENT THERMAL IMPEDANCE  
DOUBLE SIDE COOLED

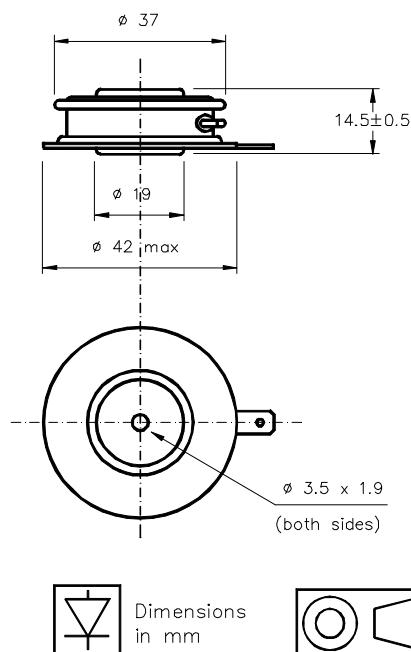
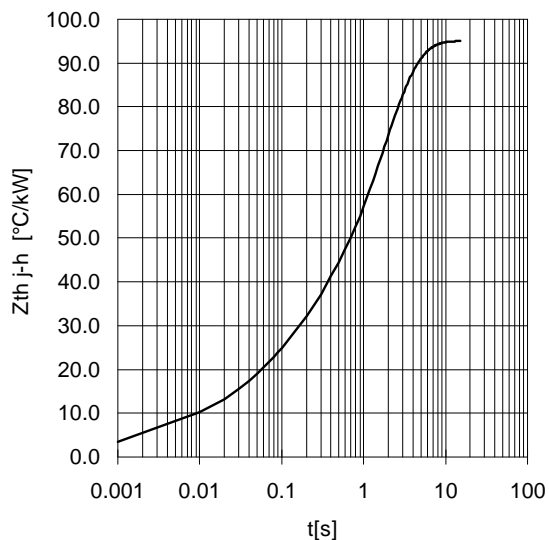

All the characteristics given in this data sheet are guaranteed only with uniform clamping force, cleaned and lubricated heatsink, surfaces with flatness < .03 mm and roughness < 2 μm.

In the interest of product improvement ANSALDO reserves the right to change any data given in this data sheet at any time without previous notice.

If not stated otherwise the maximum value of ratings (symbols over shaded background) and characteristics is reported.

Distributed by

