

AS1301

Data Sheet

5V/50mA Low Noise Inductorless Boost Converter

www.datasheet4u.com

1 General Description

The AS1301 is a 50mA inductorless boost converter using a double H-bridge charge-pump topology with two external flying capacitors.

The AS1301 runs on a 1MHz fixed frequency and is utilized with a low noise regulation scheme to allow usage together with sensitive RF circuitry from the same battery supply.

Designed to reside in portable and space limited equipment the 1MHz charge pump converts a 2.7 to 5.25V input to regulated 5V output with 5% accuracy.

The shutdown function reduces the supply current to $<5\mu\text{A}$ and disconnects the load from the output. The integrated soft-start circuitry prevents current spikes being drawn from the battery during start-up.

The AS1301 is available in TDFN (3x3x0.8mm) 10-pin and WL-CSP 8-bumps packages.

2 Key Features

- Up to 92% Efficiency
- 2.7 to 5.25V Input Voltage
- Regulated 5V Output
- Automatic Mode Up-Switching
- $<5\mu\text{A}$ Shutdown Current
- 5V Tolerant Enable Signal
- Up to 50mA Load Current
- Overload Protection
- Output Disconnected During Shutdown
- Soft Start
- No Inductor Required
- Small External Components Required ($C_{\text{OUT}} \leq 2.2\mu\text{F}$, $C_{\text{FLY}} \leq 220\text{nF}$)
- Low Noise Fixed Frequency 1MHz Charge Pump:
 - 1:1 Battery Feed Through Mode
 - 2:3 Single Phase Mode
 - 1:2 Dual Phase Mode
- Package Options:
 - TDFN (3x3x0.8mm) 10-pin
 - WL-CSP 8-bumps with 0.5mm pitch

3 Applications

The device is ideal for dual/triple AA cells or single Li-Ion battery cell to 5V conversion, mobile phones, portable instruments, microprocessor based systems, remote data-acquisition systems, inductorless DC-DC conversion.

Figure 1. Block Diagram

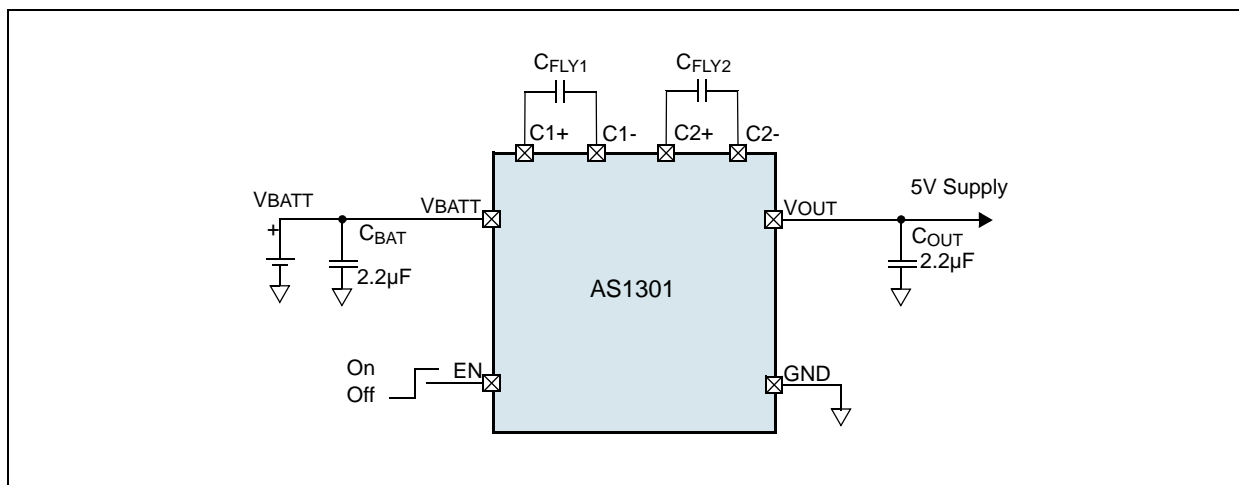

4 Pin Assignments

Figure 2. Pin Assignments (Through View)

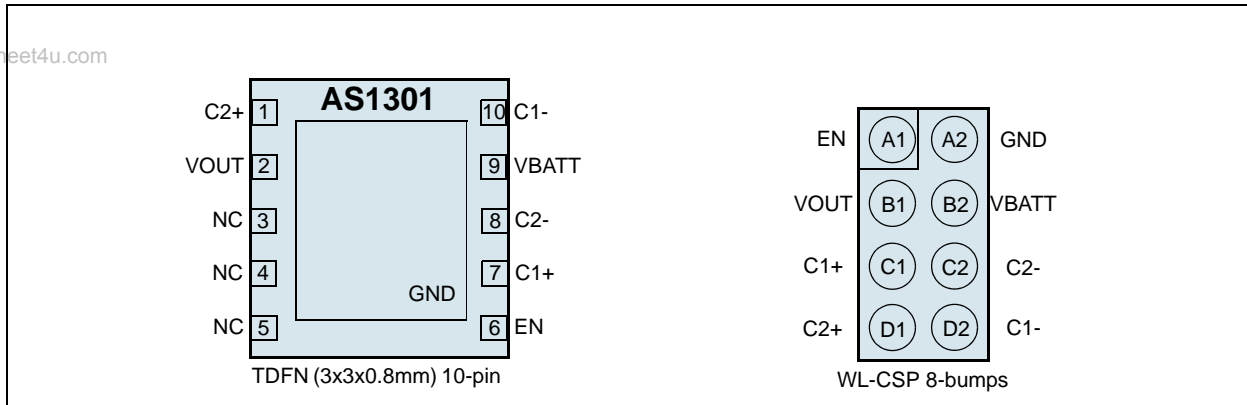

Pin Descriptions

Table 1. Pin Descriptions

Pin Name	WLP Pinout	TDFN Pin Number	Description
EN	A1	6	Enable (operating if EN=1)
VOUT	B1	2	Output voltage of the charge pump
C1+	C1	7	Connector to flying Cap 1
C1-	D2	10	Connector to flying Cap 1
C2-	C2	8	Connector to flying Cap 2
C2+	D1	1	Connector to flying Cap 2
VBATT	B2	9	Supply voltage
GND	A2	Exposed Pad	Ground
NC	-	3	Leave open or connect to GND
NC	-	4	Leave open or connect to GND
NC	-	5	Leave open or connect to GND

5 Absolute Maximum Ratings

Stresses beyond those listed in [Table 2](#) may cause permanent damage to the device. These are stress ratings only, and functional operation of the device at these or any other conditions beyond those indicated in [Section 6 Electrical Characteristics on page 4](#) is not implied. Exposure to absolute maximum rating conditions for extended periods may affect device reliability.

Table 2. Absolute Maximum Ratings

Parameter	Min	Max	Units	Notes
All pins to GND	-0.3	+7.0	V	
Operating Temperature Range	-40	+85	°C	
Storage Temperature Range	-65	+125	°C	
ESD	2		kV	HBM MIL-Std. 883E 3015.7 methods
Package Body Temperature	+260		°C	The reflow peak soldering temperature (body temperature) specified is in accordance with IPC/JEDEC J-STD-020C "Moisture/Reflow Sensitivity Classification for Non-Hermetic Solid State Surface Mount Devices". The lead finish for Pb-free leaded packages is matte tin (100% Sn).

6 Electrical Characteristics

$V_{IN} = 2.7$ to $5.25V$, $V_{OUT} = 5V$, $C_{OUT} = C_{BAT} = 2.2\mu F$, $C_{FLY1} = C_{FLY2} = 220nF$ $T_{AMB} = -40$ to $+85^{\circ}C$. Typical values are at $T_{AMB} = +25^{\circ}C$. Unless otherwise specified.

www.datasheet.com Table 3. Electrical Characteristics

Symbol	Parameter	Conditions	Min	Typ	Max	Units
V_{ON}	Startup Voltage, Rising V_{BATT}			2.8	2.865	V
V_{OFF}	Startup Voltage, Falling V_{BATT}		2.505	2.7	2.8	V
V_{BATT}	Battery Supply Voltage		V_{ON}/V_{OFF}	3.6	5.25	V
V_{CP5}	Settled Average Output Voltage	$V_{OUT} = 5.1V$ typ @ no load	4.75	5.0	5.25	V
I_{OUT}	Load Current	after startup of 1ms	0		50	mA
V_{ripple}	Output Voltage Ripple	$C_{OUT} = 2.2\mu F$, 50mA load		15		mV _{PP}
t_{START}	Start-up Time				1	ms
I_{inr}	Inrush Current				500	mA
$\Delta V_O/I_{O11}$	Load Regulation in 1:1 Mode	$V_{BATT} = 5V$, $I_{OUT} = 10\text{--}50mA$		2		mV/mA
$\Delta V_O/I_{O23}$	Load Regulation in 2:3 Mode	$V_{BATT} = 4.5V$, $I_{OUT} = 10\text{--}50mA$		3		
$\Delta V_O/I_{O12}$	Load Regulation in 1:2 Mode	$V_{BATT} = 3.1V$, $I_{OUT} = 10\text{--}50mA$		3		
η_{12}	Efficiency in Switching Mode	$V_{BATT} = 3.1V$, $I_{OUT} = 30mA$		90		%
η_{23}	Efficiency in Switching Mode	$V_{BATT} = 3.5V$, $I_{OUT} = 30mA$		90		%
fOSC	Oscillator Frequency	optional selectable		1		MHz
t_{debup}	Up Switching Debounce Time			256		μs
I_{OP12}	Operating Quiescent Current	1:2 mode without load		1.5	3.5	mA
I_{OP23}	Operating Quiescent Current	2:3 mode without load		1.3	3	
I_{OP11}	Operating Current 1:1 Mode	without load		0.1	0.3	
I_{OFF}	Shut Down Current	EN = 0V		0.7	5	μA
T_{OFFL}	Temperature Shut-down	Mode off		145		$^{\circ}C$
T_{OFFH}	Temperature Shut-down	Mode on		170		$^{\circ}C$
Input Levels						
V_{IH}	Input High level	Pin EN	1.5		5.5	V
V_{IL}	Input Low level		0.0		0.5	V

7 Typical Operating Characteristics

$V_{IN} = 2.7$ to 5.25 V, $V_{OUT} = 5$ V, $C_{OUT} = C_{BAT} = 2.2\mu\text{F}$, $C_{FLY1} = C_{FLY2} = 220\text{nF}$, $T_{AMB} = +25^\circ\text{C}$. Unless otherwise specified

Figure 3. Efficiency vs. Input Voltage, $I_{LOAD} = 10\text{mA}$

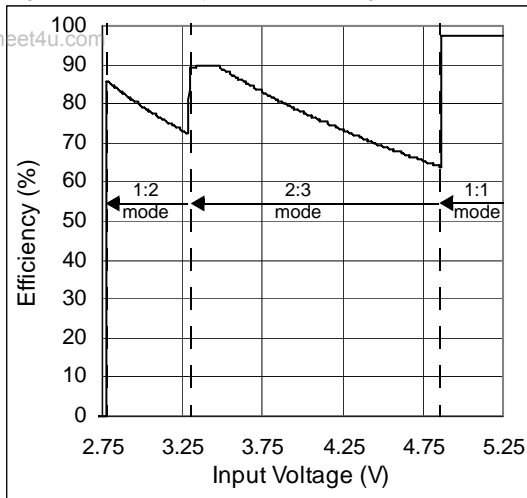

Figure 4. Efficiency vs. Input Voltage, $I_{LOAD} = 20\text{mA}$

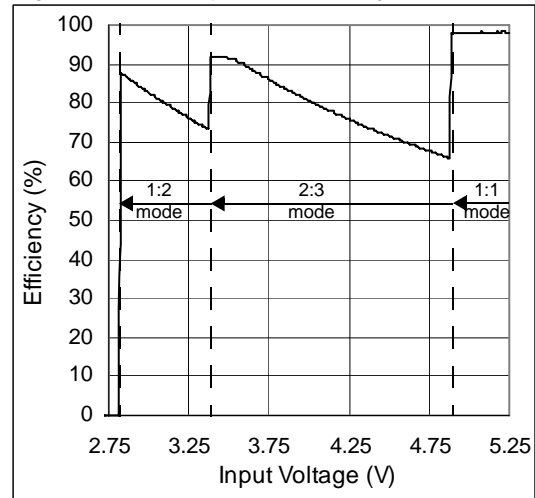

Figure 5. Efficiency vs. Input Voltage, $I_{LOAD} = 30\text{mA}$

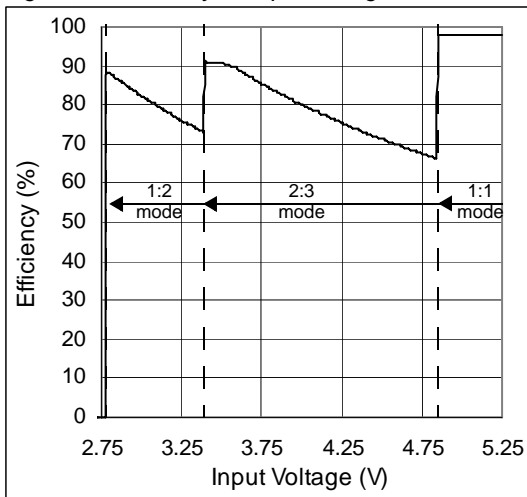

Figure 6. Efficiency vs. Input Voltage, $I_{LOAD} = 40\text{mA}$

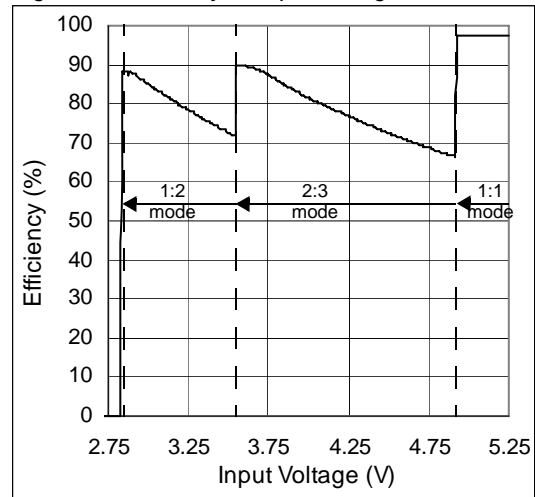

Figure 7. Efficiency vs. Input Voltage, $I_{LOAD} = 50\text{mA}$

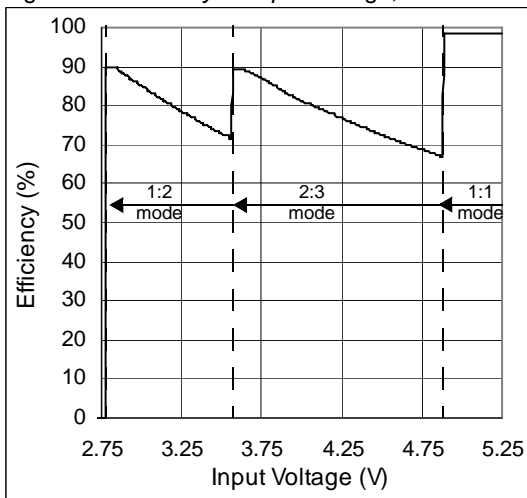

Figure 8. Quiescent Current vs. Input Voltage

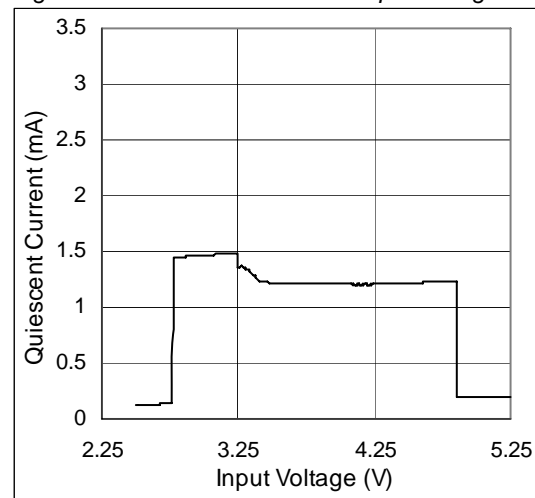

Figure 9. Output Voltage vs. Output Current

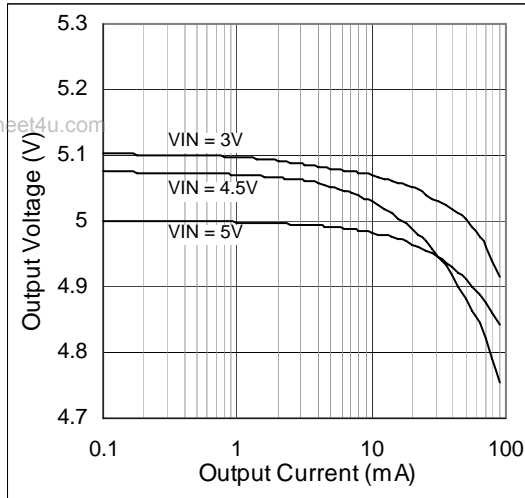

Figure 10. Output Voltage vs. Output Current

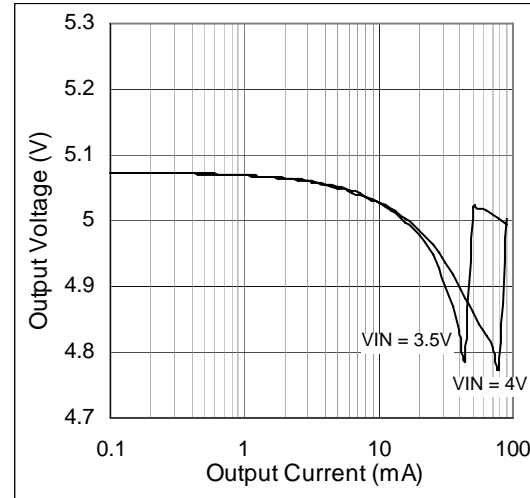

Figure 11. Output Voltage vs. Input Voltage

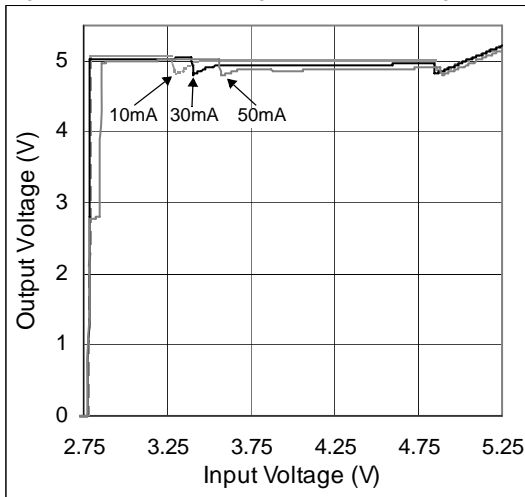

Figure 12. Output Voltage vs. Temp., $I_{OUT} = 0.1mA$

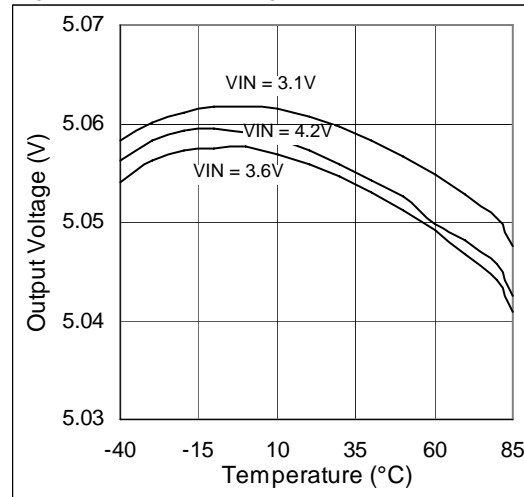

Figure 13. Output Voltage vs. Temp., $I_{OUT} = 10mA$

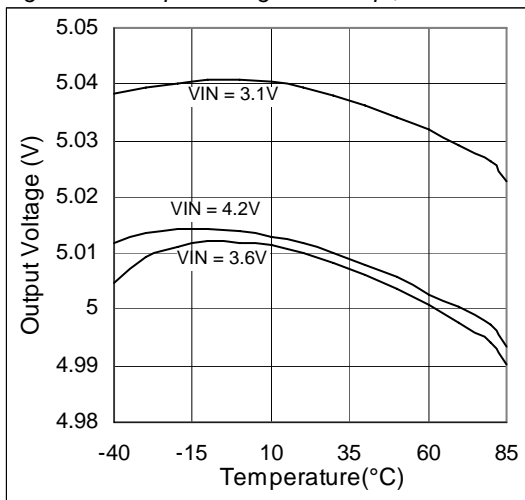

Figure 14. Output Voltage vs. Temp., $I_{OUT} = 30mA$

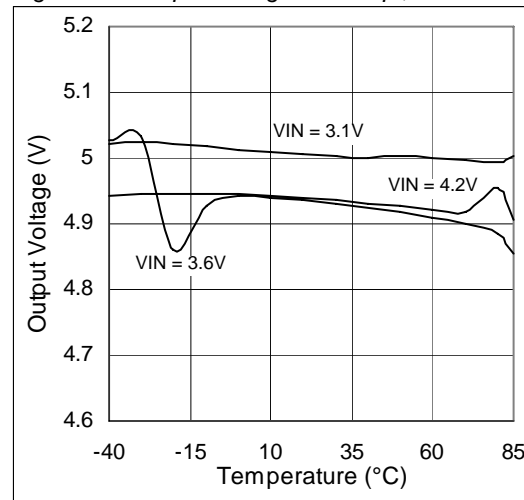

Figure 15. Efficiency vs. Output Current, $V_{IN} = 3V$

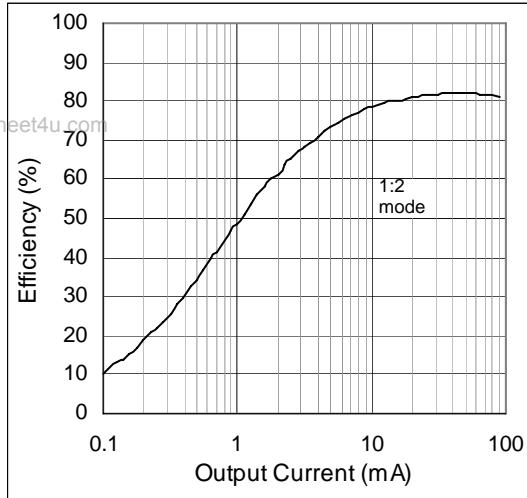

Figure 16. Efficiency vs. Output Current, $V_{IN} = 3.3V$

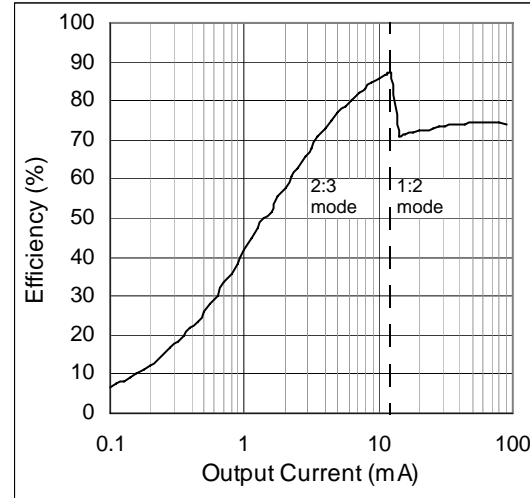

Figure 17. Efficiency vs. Output Current, $V_{IN} = 3.5V$

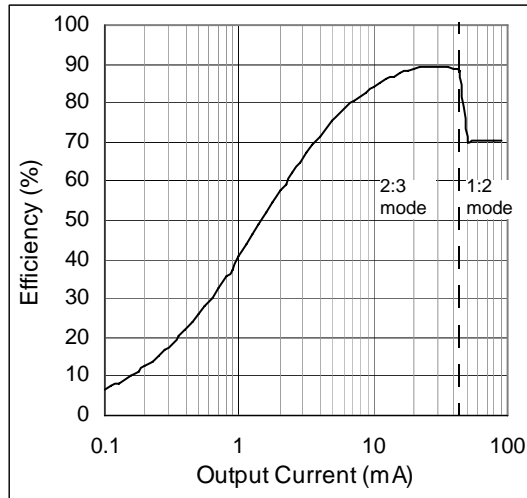

Figure 18. Efficiency vs. Output Current, $V_{IN} = 4V$

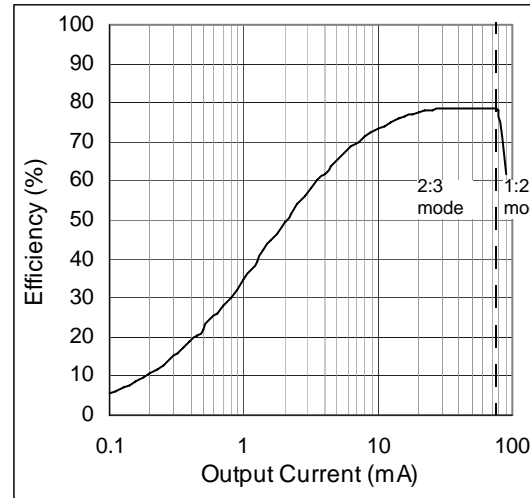

Figure 19. Efficiency vs. Output Current, $V_{IN} = 4.3V$

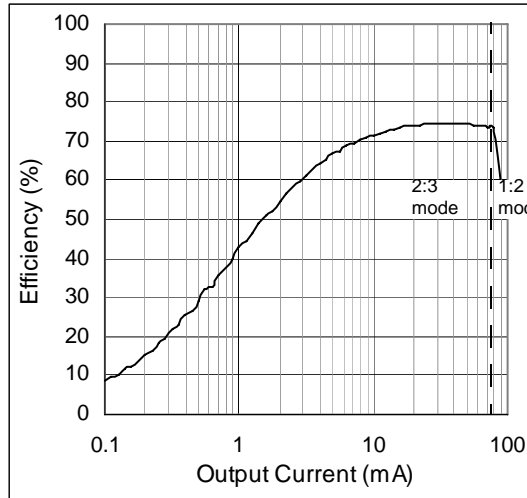

Figure 20. Efficiency vs. Output Current, $V_{IN} = 4.7V$

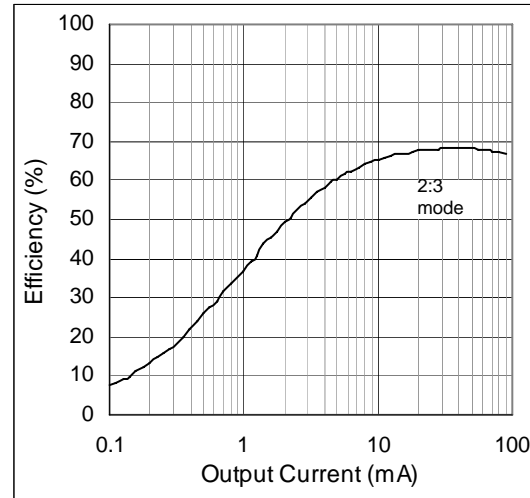

Figure 21. Load Transient, $V_{IN} = 5.2V$

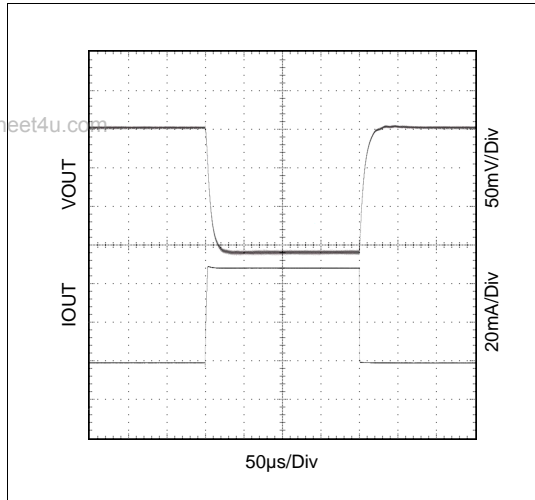

Figure 22. Load Transient, $V_{IN} = 3.6V$

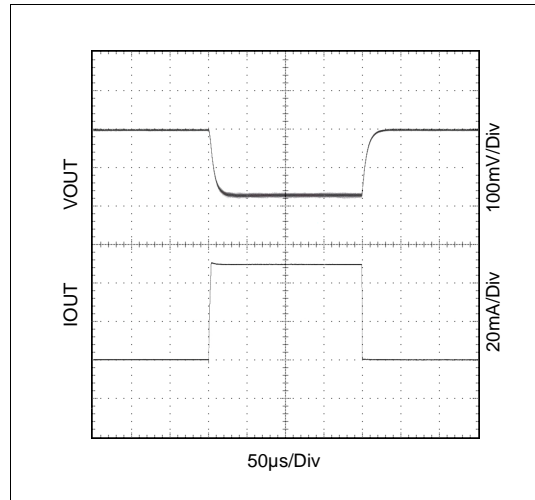

Figure 23. Start-Up Time, $V_{IN} = 3V$

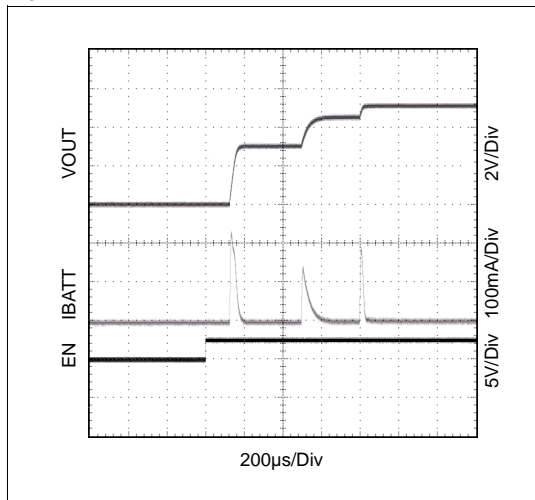

Figure 24. Start-Up Time, $V_{IN} = 5.25V$

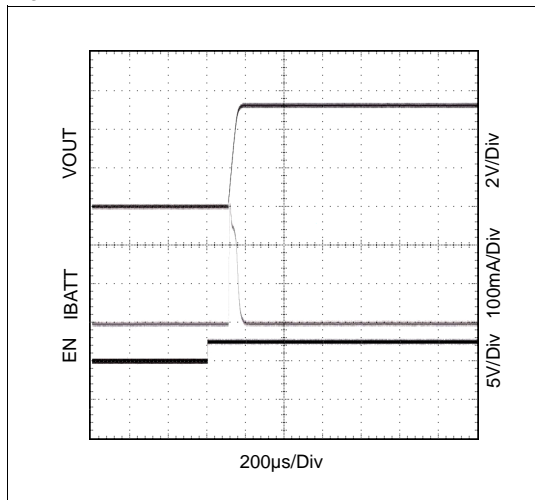
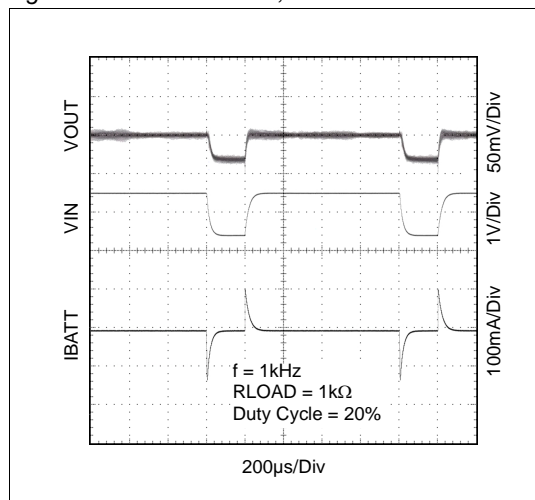

Figure 25. Line Transient, $V_{IN} = 4.5V$ to $3.5V$



8 Detailed Description

Operating Principle

www.datash... Functional Description

The AS1301 is a high efficiency and low noise switched capacitor DC/DC converter that is capable of boost operation. It is equipped with two built-in coupled H-bridge type switch configurations. Based on the value of the output voltage the system automatically initiates mode up-switching to achieve the highest possible efficiency. The regulation of the output voltage is achieved by a regulation loop, which modulates the on-resistance of the power transistors so that the amount of charge transferred from the input to the output at each clock cycle is controlled and is equal to the charge needed by the load.

Regulation Loop

The AS1301 operates at constant frequency at any load. For the regulation loop power transistors, a resistor divider, and an error amplifier is used to keep the output voltage within the allowed limits. The error amplifier, including loop-filter and compensation ramp, takes feedback and reference as inputs and generates the error voltage signal. The error voltage is then used as the gate voltage of the power transistor which modulates the on-resistance of the latter. The modulated transistor on-resistance controls the charge transferred from the input to the output and therefore the regulation of the output is realized. Based on adjusting of the amount of charge transferred, this regulation concept delivers the smallest voltage ripple possible.

Figure 26. Functional Block Diagram

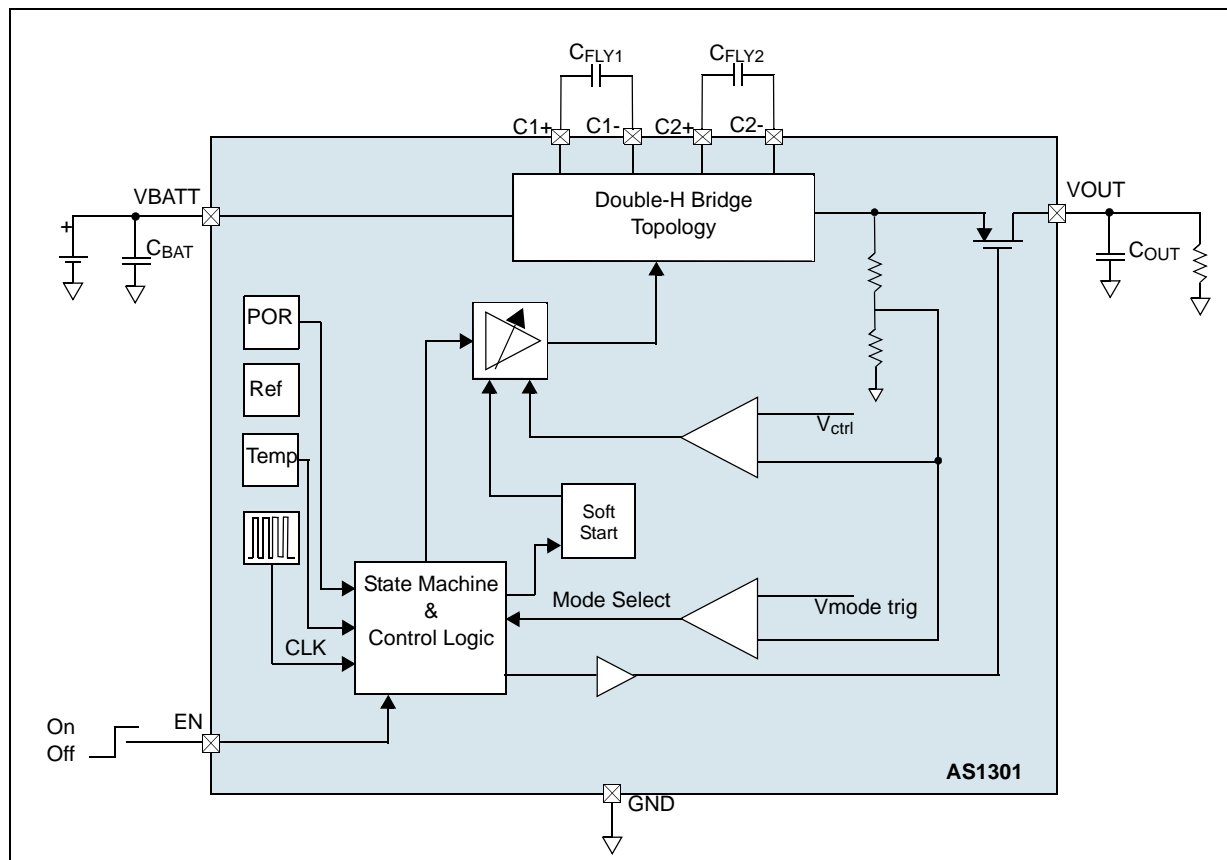

Switch Configuration

The AS1301 has nine built-in power switches in the shape of two coupled H-bridge topologies. The system features 1:2 and 2:3 operation mode as well as an 1:1 operation where the input is directly connected to the output. This feedthrough mode is suitable for input voltages higher than the output voltage.

In 2:3 operation mode two flying capacitors are placed in series and each capacitor is charged to a half of the input voltage. In pumping phase the flying capacitors are placed in parallel. The bottom-plate of the parallel flying capacitors C_{FLY1} and C_{FLY2} is then connected to the input voltage so that the voltage at the top-plate of the parallel flying capacitors is boosted to a voltage equal to $V_{BATT} + V_{BATT}/2$. By connecting the top-plate of the capacitors to the output, the output voltage in 2:3 mode can be up to one and a half of V_{BATT} . If the top-plate voltage is higher than 5V, the regulation loop adapts the power transistor's on-resistance to drop some voltage. The 2:3 operation mode runs in single-phase operation only.

Figure 27. 2:3 Single Phase Operating Mode

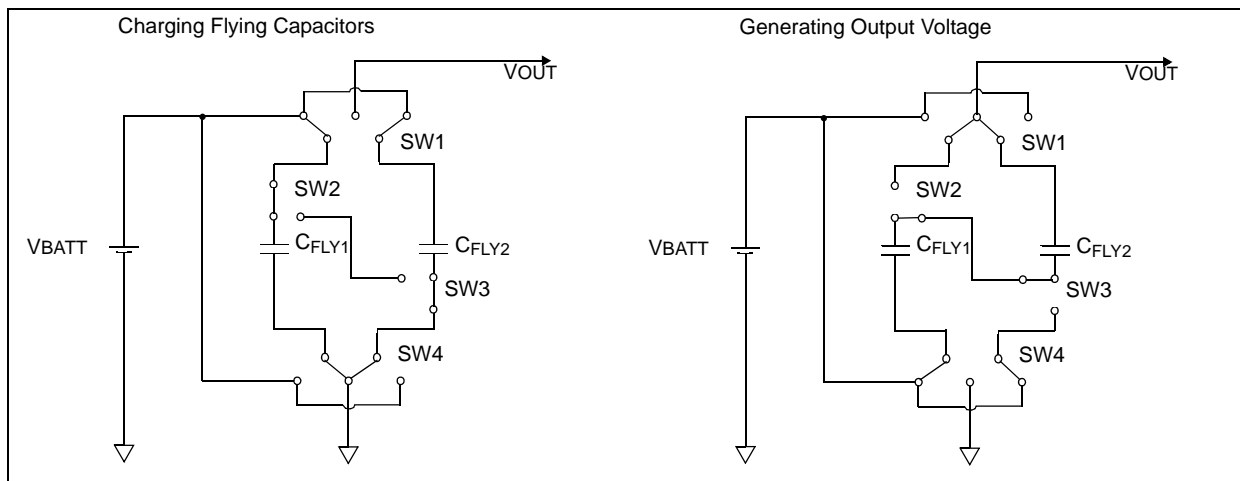

In 1:2 operation mode just one of both flying capacitors is placed in series to the input voltage, and therefore charged to the input voltage. During pumping phase the input voltage is connected to the bottom of the charged flying capacitor C_{FLY} . The voltage at the top-plate of the capacitor is now boosted to $2V_{BATT}$. By connecting the top-plate of the capacitor to the output, the output can be charged to double of V_{BATT} . If the top-plate voltage is higher than 5V the regulation loop limits the charge transfer to the output. In collaboration with the second flying capacitor this mode features dual-phase operation.

Figure 28. 1:2 Dual Phase Operating Mode

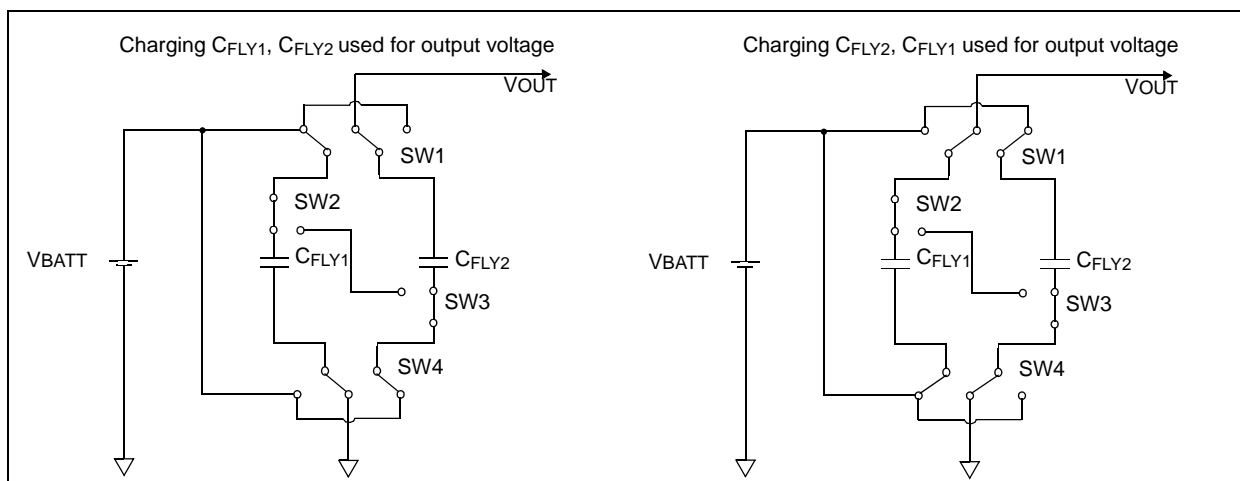

Overload Protection

When the output voltage drops about 200mV below battery voltage due to very high load the AS1301 enters overload protection condition. In this condition the output is connected to the input via a current limiting connection. Once the overload is removed, the device enters soft start periode and ramps up to the nominal output voltage.

www.datasheet4u.com

Undervoltage Lockout

The AS1301 is equipped with an undervoltage lockout functionality. If the battery voltage drops below 2.7V (typ) the device enters the undervoltage lockout condition. The device remains in this condition until the battery voltage is high enough to enter the soft start period. An internal hysteresis of 100mV will prevent ringing during startup. If the input voltage climbs back to 2.8V (typ) after such a condition the device will turn-on automatically again.

Shutdown Mode

The AS1301 enters low-power shutdown mode when EN is logic low. In shutdown the charge-pump action is halted, the output is completely disconnected from the input and V_{OUT} will drop to 0V. During shutdown the output voltage can be forced higher then the input voltage, because the permanent monitoring of the input- and output voltage will prevent an erroneous current form the output back to the input during shutdown.

Thermal Shutdown

The AS1301 offers thermal shutdown, which prevents eventual damage due to an over-temperature condition. Thermal shutdown will be initiated if the junction temperature exceeds 145°C. If the temperature drops below this value, the thermal shutdown will be released automatically and the device will resume operation.

9 Application Information

External Component Selection

The high internal oscillator frequency of 1MHz permits the use of small capacitors for both the flying capacitors and the output capacitors. For any given load value of the flying- and output capacitors as well as their ESR are affecting the output voltage performance.

In general, the capacitor's ESR is inversely proportional to its physical size. Larger capacitances and higher voltage ratings tend to reduce ESR. The ESR is a function of the frequency too, so it must be rated at the devices operating frequency. Another factor affecting capacitor ESR is temperature.

Note: Many capacitors have a huge capacity variation over temperature. This can be compensated by choosing a capacitor with a better thermal coefficient or by choosing a larger nominal value to ensure proper operation over temperature.

Input and Output Capacitor Selection

It is not critical which type of input bypass capacitor C_{BAT} and output filter capacitor C_{OUT} is used, but it will still affect the performance of the charge-pump. Low ESR capacitors should be used to minimize V_{OUT} ripple. Multi-layer ceramic capacitors are recommended since they have extremely low ESR and are available in small footprints.

Input Capacitor

An 1.2 μ F/2.2 μ F input bypass low ESR capacitor such as tantalum or ceramic is recommended to reduce noise and supply transients. During startup and mode change it supplies part of the peak input current drawn by the device.

Table 4. Recommended Input Capacitor

Part Number	C	TC Code	Rated Voltage	Dimensions (L/W/T)	Manufacturer
GRM21BR71A225KA01	2.2 μ F	X7R	10V	2x1.2x1.35mm	Murata www.murata.com

Output Capacitor

The output capacitor is charged to the V_{OUT} voltage during pumping phase. The ESR of the output capacitor introduces steps in the output voltage waveform whenever the charge pump charges C_{OUT} . These steps contribute to the ripple voltage of V_{OUT} . Therefore, ceramic or tantalum low ESR capacitors are recommended for C_{OUT} to minimize the output voltage ripple.

Table 5. Recommended Output Capacitor

Part Number	C	TC Code	Rated Voltage	Dimensions (L/W/T)	Manufacturer
GRM21BR71A225KA01	2.2 μ F	X7R	10V	2x1.2x1.35mm	Murata www.murata.com

Charge-Pump Capacitor Selection

To ensure the required output current and avoid high peak currents the values of the flying capacitors C_{FLY1} and C_{FLY2} are very critical. A 120nF capacitor is sufficient for most applications. Dependent on the operation mode the AS1301 alternately charges and discharges the $C_{FLY1/2}$. While the ESR of the output capacitor produces part of the output voltage ripple, the voltage drop caused by the ESR of the flying capacitors affects the maximum available output voltage. Therefore low ESR capacitors, e.g. tantalum or ceramic, are recommended for the flying capacitors as well.

Table 6. Recommended Charge-Pump Capacitor

Part Number	C	TC Code	Rated Voltage	Dimensions (L/W/T)	Manufacturer
GRM188R71E224KA88	220nF	X7R	25V	1.6x0.8x0.87mm	Murata www.murata.com

10 Package Drawings and Markings

The device is available in a TDFN (3x3x0.8mm) 10-pin and WL-CSP 8-bumps package.

Figure 29. TDFN (3x3x0.8mm) 10-pin package Diagram

www.datasheet4u.com

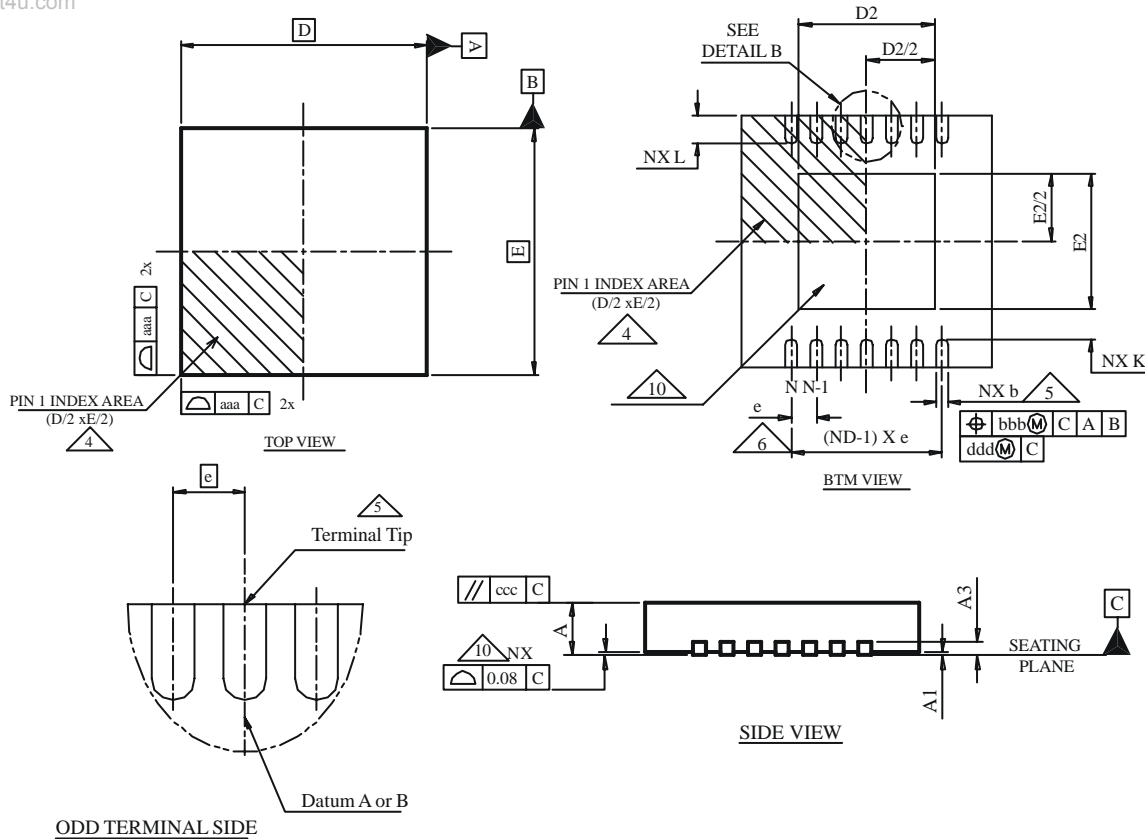

Table 7. TDFN (3x3x0.8mm) 10-pin package Dimensions

Symbol	Min	Typ	Max	Symbol	Min	Typ	Max
A	0.70	0.75	0.80	D BSC		3.00	
A1	0.00	0.02	0.05	E BSC		3.00	
A3		0.20 REF		D2	2.20		2.70
L1	0.03		0.15	E2	1.40		1.75
L2			0.13	L	0.30	0.40	0.50
aaa		0.15		θ	0°		
bbb		0.10		k	0.20		
ccc		0.10		b	0.18	0.25	0.30
ddd		0.05		e		0.50	
eee		0.08		N		10	
ggg		0.10		ND		5	

Note:

1. Dimensioning and tolerancing conform to ASME Y14.5M-1994.
2. All dimensions are in millimeters, angle is in degrees.
3. N is the total number of terminals.

Figure 30. WL-CSP 8-bumps Package Diagram

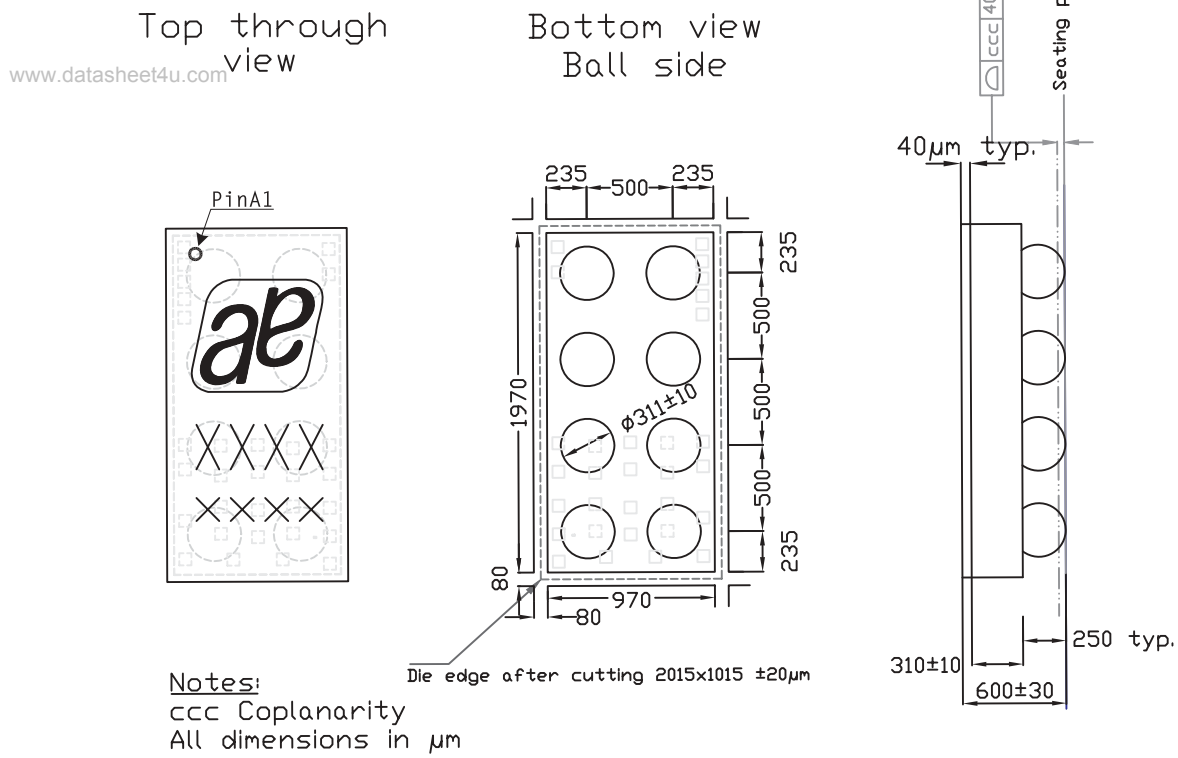

11 Ordering Information

Table 8. Ordering Information

Part	Marking	Description	Delivery Form	Package
AS1301A-BWLT	ASO4	5V/50mA Low Noise Inductorless Boost Converter	T&R	WL-CSP 8-bumps
AS1301A-BTDT	ASO4	5V/50mA Low Noise Inductorless Boost Converter	T&R	TDFN (3x3x0.8mm) 10-pin

Copyrights

Copyright © 1997-2007, austriamicrosystems AG, Schloss Premstaetten, 8141 Unterpemstaetten, Austria-Europe. Trademarks Registered ®. All rights reserved. The material herein may not be reproduced, adapted, merged, translated, stored, or used without the prior written consent of the copyright owner.

www.datasheet4u.com

All products and companies mentioned are trademarks or registered trademarks of their respective companies.

Disclaimer

Devices sold by austriamicrosystems AG are covered by the warranty and patent indemnification provisions appearing in its Term of Sale. austriamicrosystems AG makes no warranty, express, statutory, implied, or by description regarding the information set forth herein or regarding the freedom of the described devices from patent infringement. austriamicrosystems AG reserves the right to change specifications and prices at any time and without notice. Therefore, prior to designing this product into a system, it is necessary to check with austriamicrosystems AG for current information. This product is intended for use in normal commercial applications. Applications requiring extended temperature range, unusual environmental requirements, or high reliability applications, such as military, medical life-support or life-sustaining equipment are specifically not recommended without additional processing by austriamicrosystems AG for each application. For shipments of less than 100 parts the manufacturing flow might show deviations from the standard production flow, such as test flow or test location.

The information furnished here by austriamicrosystems AG is believed to be correct and accurate. However, austriamicrosystems AG shall not be liable to recipient or any third party for any damages, including but not limited to personal injury, property damage, loss of profits, loss of use, interruption of business or indirect, special, incidental or consequential damages, of any kind, in connection with or arising out of the furnishing, performance or use of the technical data herein. No obligation or liability to recipient or any third party shall arise or flow out of austriamicrosystems AG rendering of technical or other services.



Contact Information

Headquarters

austriamicrosystems AG
A-8141 Schloss Premstaetten, Austria

Tel: +43 (0) 3136 500 0
Fax: +43 (0) 3136 525 01

For Sales Offices, Distributors and Representatives, please visit:

<http://www.austriamicrosystems.com/contact>