

GaAs IC Reflective SPDT with Driver 3–6 GHz



AS210-321

Features

- T_X/R_X Switch for IEEE 802.11a Wireless LAN Applications
- Positive CMOS Level Control (0, +3 V)
- Low Loss (< 1.3 dB)
- Low DC Power Consumption
- QFN-12 3 x 3 mm Package
- Low Cost
- No External Components Needed

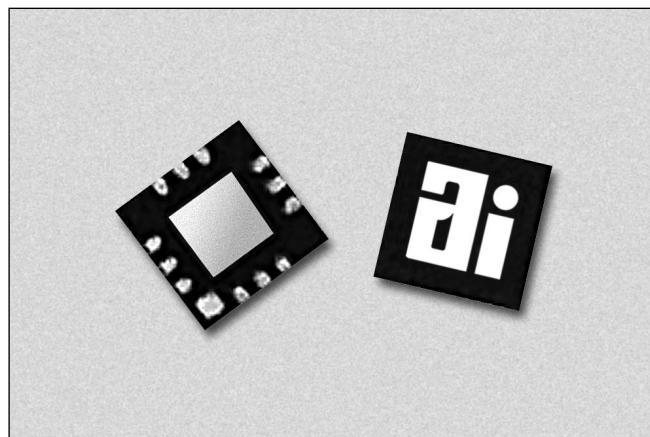

Description

The AS210-321 is a GaAs PHEMT SPDT reflective switch that has been designed for WLAN T_X/R_X applications. This device has been optimized to provide excellent performance from 3–6 GHz. The AS210-321's low insertion loss make it an ideal choice for the 802.11a and 3.5 GHz fixed wireless LAN applications.

Absolute Maximum Ratings

Characteristic	Value
RF Input Power	1 W Max. > 500 MHz
Supply Voltage	-0.2 V, +6 V
Control Voltage	-0.2 V, +6 V
Operating Temperature	-40°C to +85°C
Storage Temperature	-65°C to +150°C

Electrical Specifications at 25°C (0, +3 V)

Parameter	Frequency	Min.	Typ.	Max.	Unit
Insertion Loss	3–4 GHz		1.5	1.8	dB
	5–6 GHz		1.0	1.5	dB
Isolation	3–5 GHz	23	27		dB
	5–6 GHz	25	29		dB
Return Loss (On State)	3–6 GHz	7.5	12		dB

Operating Characteristics at 25°C (0, +3 V)

Parameter	Condition	Frequency	Min.	Typ.	Max.	Unit
Switching Characteristics	Rise, Fall (10/90% or 90/10% RF)			100		ns
	On, Off (50% CTL to 90/10% RF)			150		ns
	Video Feedthru			25		mV
Input Intermodulation Intercept Point (IIP3)	0/+3 V	5–6 GHz		50		dBm
Control Voltages (C ₁)	C ₁ = "0" with @ 700 μA Max.		0		0.4	V
	C ₁ = "1" with @ 500 μA Max.		2.4		5.0	V
Supply Voltage (V _S)			3.0		5.0	V
Supply Current				400	700	μA

Typical Performance Data at 25°C

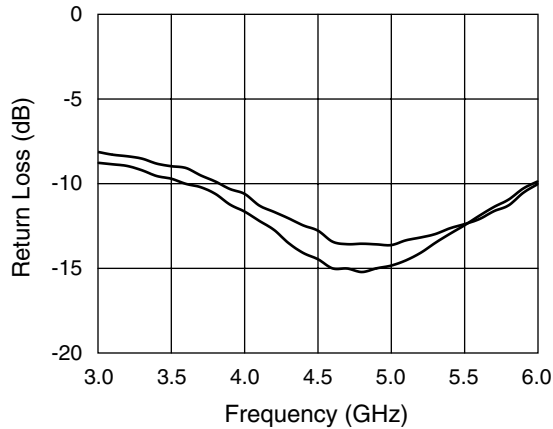

Return Loss vs. Frequency

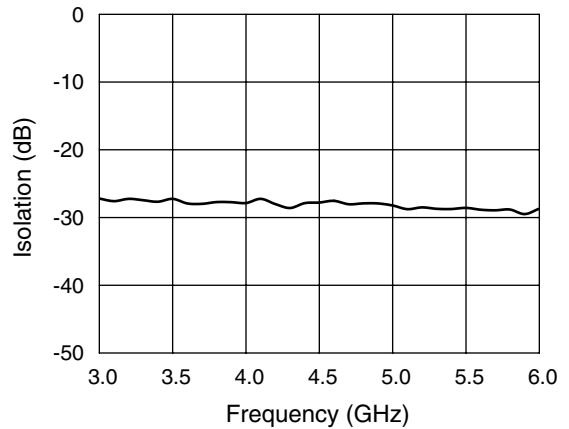

Isolation vs. Frequency

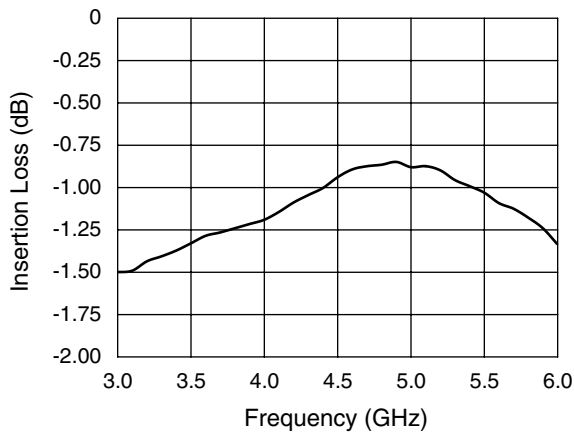

Insertion Loss vs. Frequency

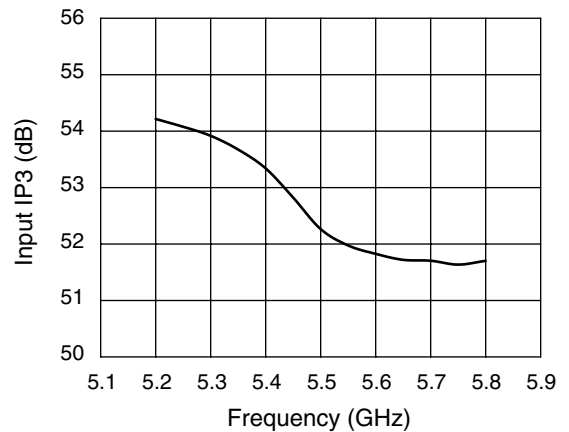

Input IP3 vs. Frequency

Truth Table

C ₁	J ₁ -J ₂	J ₂ -J ₃
0	Isolation	Insertion Loss
1	Insertion Loss	Isolation

Pin Out (Top View)

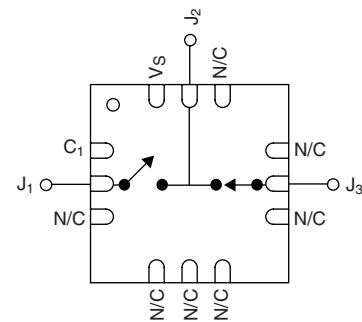

Ground is connected to paddle on bottom.

Evaluation Board Layout

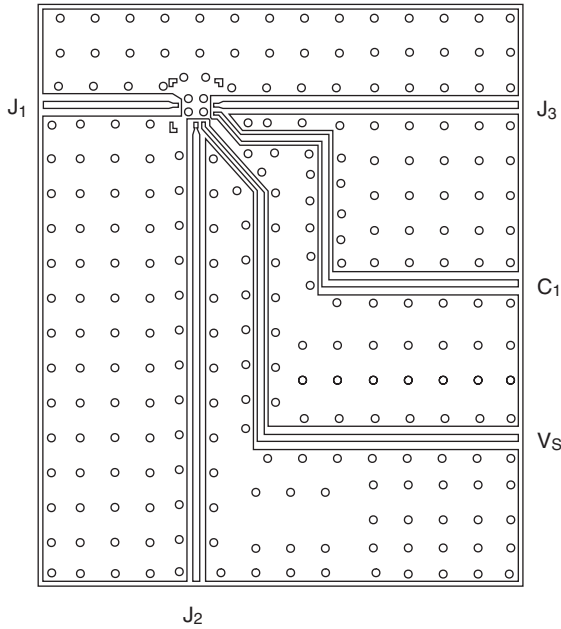

QFN-12

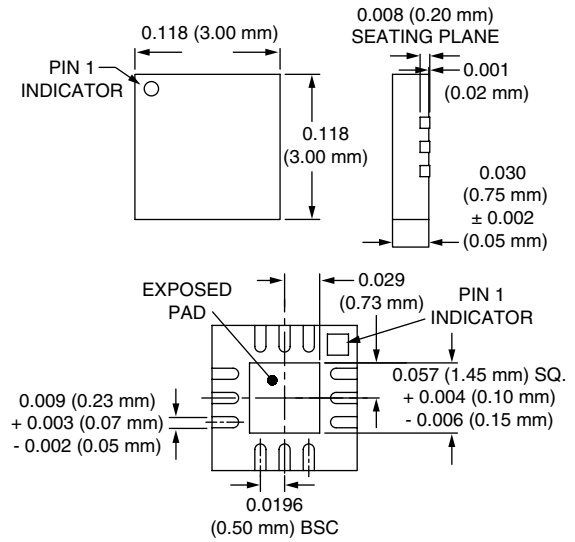

Typical S-Parameters (Control Voltage 0/+3 V)

Insertion Loss State # GHz S MA R 50									Isolation State # GHz S MA R 50							
Freq. (GHz)	S ₁₁	S _{11a}	S ₂₁	S _{21a}	S ₁₂	S _{12a}	S ₂₂	S _{22a}	S ₁₁	S _{11a}	S ₂₁	S _{21a}	S ₁₂	S _{12a}	S ₂₂	S _{22a}
3.0	0.39	261.74	0.84	71.69	0.86	71.02	0.36	216.00	0.80	204.12	0.044	80.43	0.044	80.60	0.37	214.92
3.5	0.36	192.95	0.85	15.37	0.87	14.18	0.33	146.47	0.77	126.78	0.043	29.93	0.043	29.95	0.32	147.00
4.0	0.29	126.56	0.86	-39.06	0.86	-39.01	0.26	72.34	0.76	51.10	0.040	-11.65	0.040	-11.09	0.25	77.55
4.5	0.23	72.00	0.89	266.35	0.89	266.77	0.19	-18.71	0.72	-27.26	0.041	-56.14	0.041	-56.39	0.18	-3.67
5.0	0.21	21.24	0.90	211.21	0.90	211.52	0.18	241.37	0.70	249.53	0.039	248.64	0.039	250.86	0.17	256.52
5.5	0.24	-52.64	0.89	155.77	0.89	155.87	0.24	165.97	0.71	170.47	0.037	208.18	0.037	208.61	0.25	172.76
6.0	0.32	215.58	0.85	99.29	0.85	100.14	0.32	107.90	0.74	101.73	0.037	171.03	0.037	170.45	0.34	104.97

Measured S-Parameters include the evaluation board.