



AS2880

8A Low Dropout Voltage Regulator Adjustable & Fixed 3.3V

FEATURES

- Adjustable Output Down to 1.2V or Fixed 3.3V & 5V
- Output Current of 8A
- Low Dropout Voltage
- Extremely Tight Load and Line Regulation
- Current & Thermal Limiting
- Standard 3-Terminal Low Cost TO-220
- Similar to Industry Standard LT1083/LT1584

APPLICATIONS

- Powering Intel Pentium™ μ P from +5V Supplies
- Power PC™ Supplies
- SMPS Post-Regulator
- High Efficiency "Green" Computer Systems
- High Efficiency Linear Power Supplies
- Portable Instrumentation
- Constant Current Regulators
- Adjustable Power Supplies
- Battery Charger

PRODUCT DESCRIPTION

The AS2880 is a low power 8A Adjustable Voltage Regulator that is very easy to use. It requires only 2 external resistors to set the output voltage. This device is an excellent choice when using Powering Intel™ Microprocessor to convert from +5V to 3.3V supplies, and as a post regulator for switching supplies applications. The AS2880 features low dropout of a maximum 1.5 volts.

The AS2880 offers full protection against over-current faults, reversed input polarity, reversed load insertion, over temperature operation, and positive and negative transient voltage. On-Chip trimming adjusts the reference voltage to 1%. The I_Q of this device flows into the load, which increases efficiency.

The AS2880 is offered in a 3-pin TO-220 package compatible with older 3-terminal regulators. When using ALPHA Semiconductor design, processing and testing techniques make AS2880 superior over similar products on the market. For a 5A low dropout regulator refer to the AS2850 datasheet.

ORDERING INFORMATION

TO-220
3-PIN
AS2880AU

X = Output Voltage (i.e. 3.3 for 3.3V, 5.0 for 5.0V etc.)

Y = Output Tolerance, A for 1%

Blank for 2%

Consult factory for other fixed voltages.

PIN CONNECTIONS

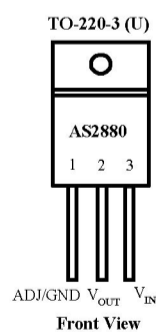

AS2880

ABSOLUTE MAXIMUM RATINGS

Power Dissipation..... Internally Limited
 Lead Temp. (Soldering, 10 Seconds)..... 300°C
 Storage Temperature Range -65° to +150°C
 Operating Junction Temperature Range
 AS2880 Control Section.....0C° to +125°C
 AS2880 Power Transistor.....0C° to +150°C

Input Supply Voltage +10V
 Input to Output Voltage Differential 8.8V

ELECTRICAL CHARACTERISTICS (Note 1) at $I_{OUT} = 10\text{mA}$, $T_A = 25^\circ\text{C}$, unless otherwise specified.

Parameter	Conditions	AS2880A			AS2880		Units
		Typ	Min	Max	Min	Max	
3.3V Version							
Output Voltage (Note 2)	AS2880-3.3V, $0 \leq I_{OUT} \leq 1.5\text{A}$, $4.75\text{V} \leq V_{IN} \leq 7\text{V}$	3.3 3.3	3.270 3.240	3.330 3.360	3.230 3.201	3.370 3.399	V
5.0V Version							
Output Voltage (Note 2)	AS2880-3.3V, $0 \leq I_{OUT} \leq 1.5\text{A}$, $6.5\text{V} \leq V_{IN} \leq 7\text{V}$	5.0 5.0	4.950 4.900	5.050 5.100	4.900 4.650	5.100 5.150	
All Voltage Options							
Reference Voltage	$10\text{mA} \leq I_{OUT} \leq I_{FULLLOAD}$ $3.3\text{V} \leq (V_{IN} - V_{OUT}) \leq V_{IN\text{MAX}} - V_{OUT\text{MAX}}$	1.250 1.250	1.238 1.225	1.262 1.270	1.238 1.225	1.262 1.270	V
Mid Load Current	$(V_{IN} - V_{OUT}) = V_{IN\text{MAX}} - V_{OUT\text{MAX}}$	5		10		10	mA
Line Regulation	$1.5\text{V} \leq V_{IN} - V_{OUT} \leq V_{IN\text{MAX}} - V_{OUT\text{MAX}}$ $I_{LOAD} = 10\text{mA}$	0.015 0.05		0.2 0.5		0.2 0.5	%
Load Regulation	$10\text{mA} \leq I_{OUT} \leq I_{FULLLOAD}$ $(V_{IN} - V_{OUT}) = 3\text{V}$	0.1 0.2		0.3 0.4		0.3 0.4	%
Dropout Voltage	$I_{OUT} = I_{FULLLOAD}$, $\Delta V_{REF} = 1\%$	1.1		1.2		1.2	V
Current Limit	$V_{IN} - V_{OUT} = 5\text{V}$	9.5	8.0		8.0		A
Long Term Stability	$T_A = 125^\circ\text{C}$, 1000Hrs.	0.3		1		1	%
Adjust Pin Current	$T_A = 25^\circ\text{C}$	55		90		90	μA
Adjust Pin Current Change		0.2		5		5	μA
Thermal Regulation	30ms pulse	0.003		0.01		0.01	%/W
Temperature Stability		0.5					%
Ripple Rejection Ratio	$V_{IN} - V_{OUT} = 3\text{V}$ $I_{OUT} = 3\text{A}$, $C_{OUT} = 25\mu\text{F}$, $C_{ADJ} = 25\mu\text{F}$, $f = 120\text{Hz}$	75	60		60		dB
Output Noise, RMS	10Hz to 10kHz	0.003					% V_O
Thermal Resistance Junction-to-Case	TO-220 Junction to Tab Junction to Ambient			2.7 0.65		2.7 0.65	$^\circ\text{C}/\text{W}$

The Bold specifications apply to the full operating temperature range.

Note 1: Changes in output voltage due to heating effects are covered under the specification for thermal regulation.

Note 2: A 10 μF output capacitor is required on AS2880

TYPICAL CHARACTERISTICS

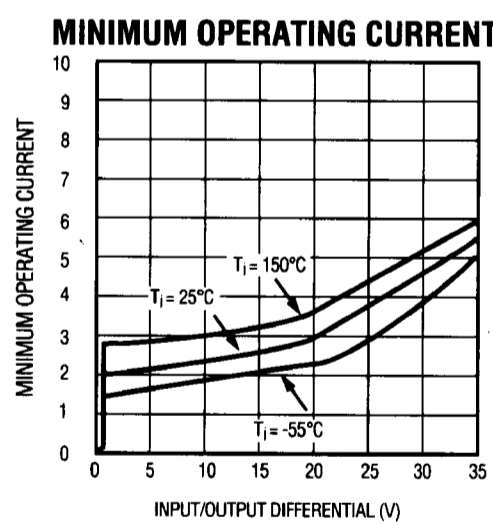
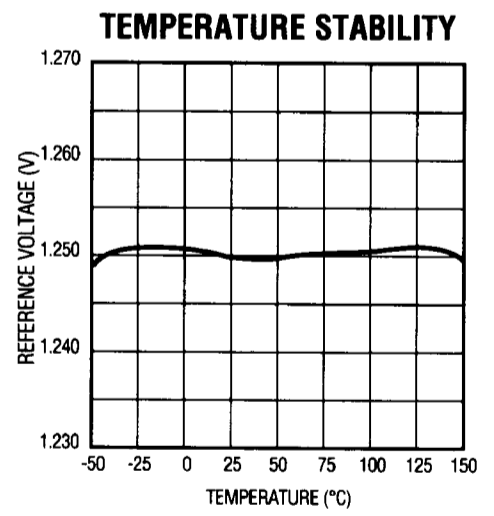
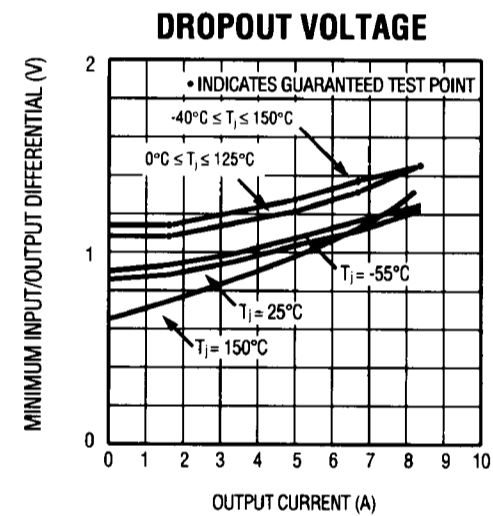
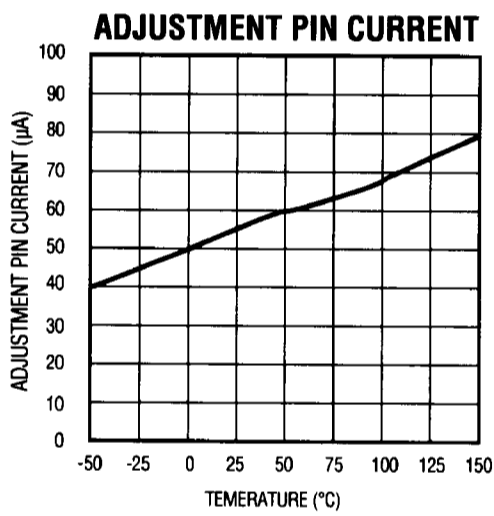
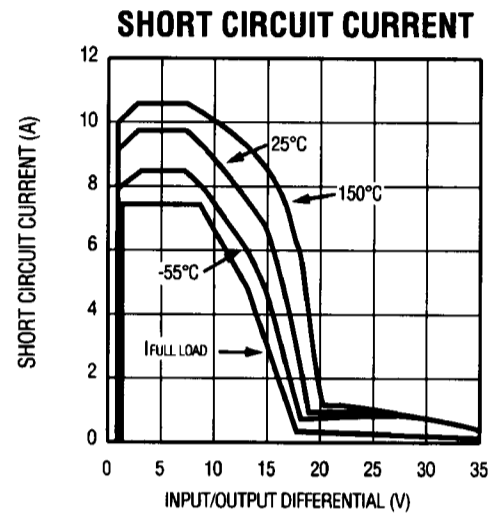
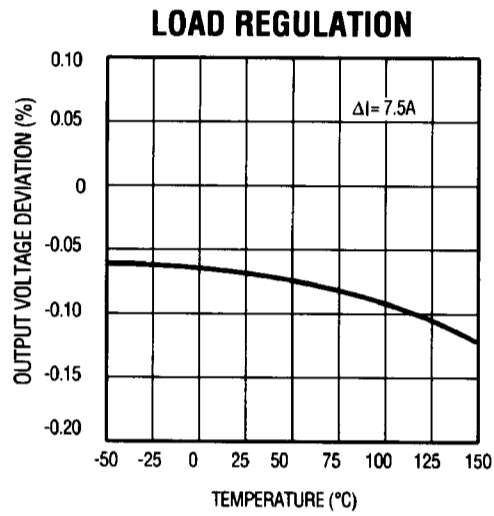

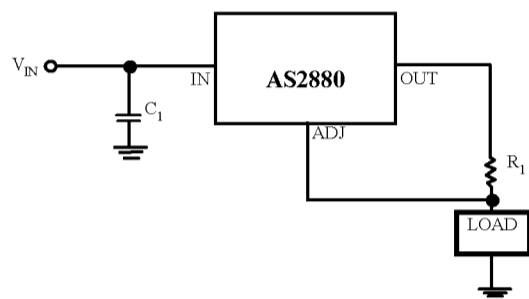
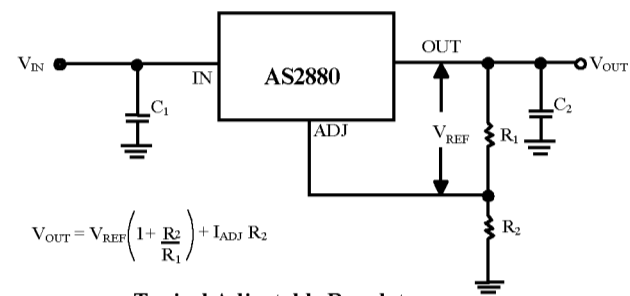
TYPICAL APPLICATIONS**8A Current Output Regulator**

$$V_{OUT} = V_{REF} \left(1 + \frac{R_2}{R_1} \right) + I_{ADJ} R_2$$

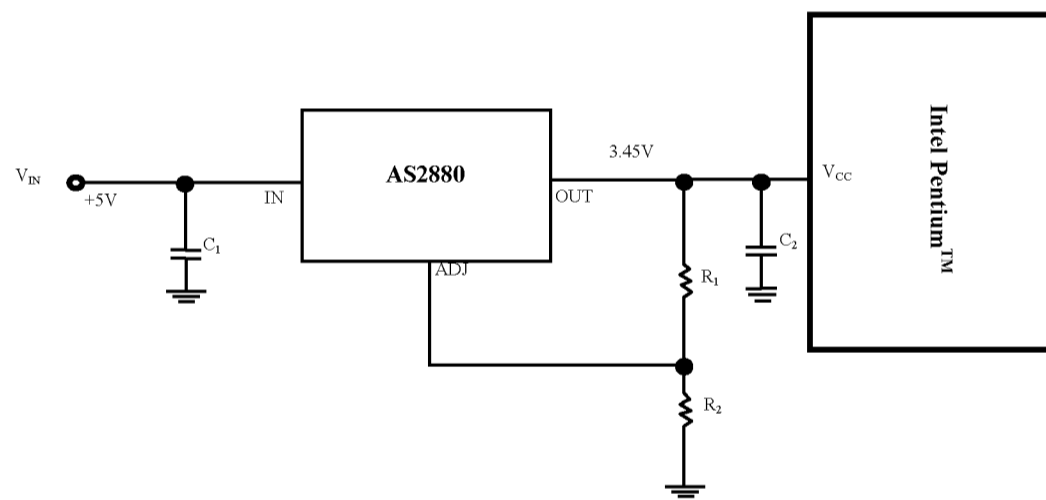
Typical Adjustable Regulator**Powering Intel Pentium™ with AS2880**

Pentium Processor is a trademark of Intel Corp. Power PC is a trademark of IBM Corp.