

REVISION H

NOTES:

1. FILL ROWS 3, 4, 7, 8 ONLY, NOT AVAILABLE AS STANDARD.
2. Ⓢ REPRESENTS A CRITICAL DIMENSION.
3. MINIMUM PUSHOUT FORCE: .75 LB.
4. PARTS TO BE PACKAGED IN TAPE & REEL.
5. TAPE AND REEL WILL BE SUPPLIED WHETHER OR NOT -TR IS SPECIFIED
6. FOR QUANTITIES UP TO 49 PIECES, NO LEADER, TRAILER OR REEL WILL BE SUPPLIED. FOR QUANTITIES OF 50-124 NO LEADER OR TRAILER WILL BE SUPPLIED

DO NOT SCALE FROM THIS PRINT

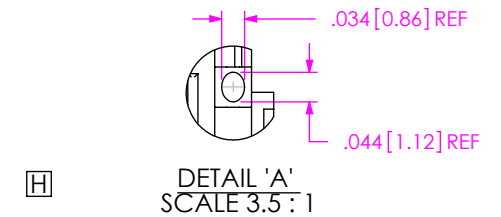
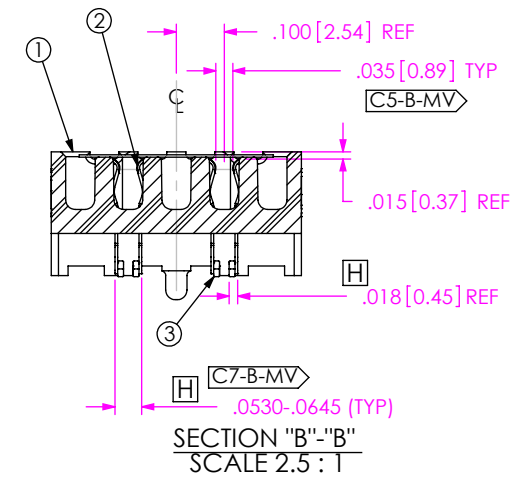
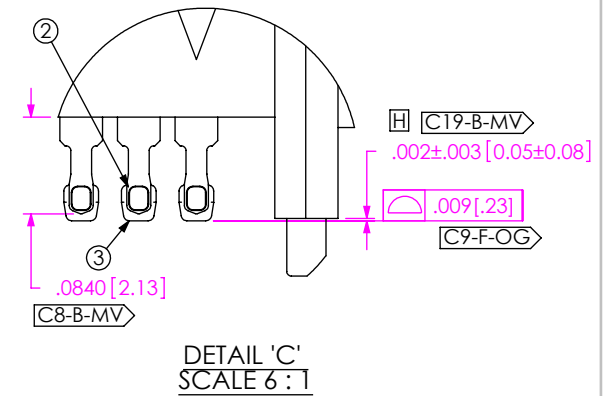
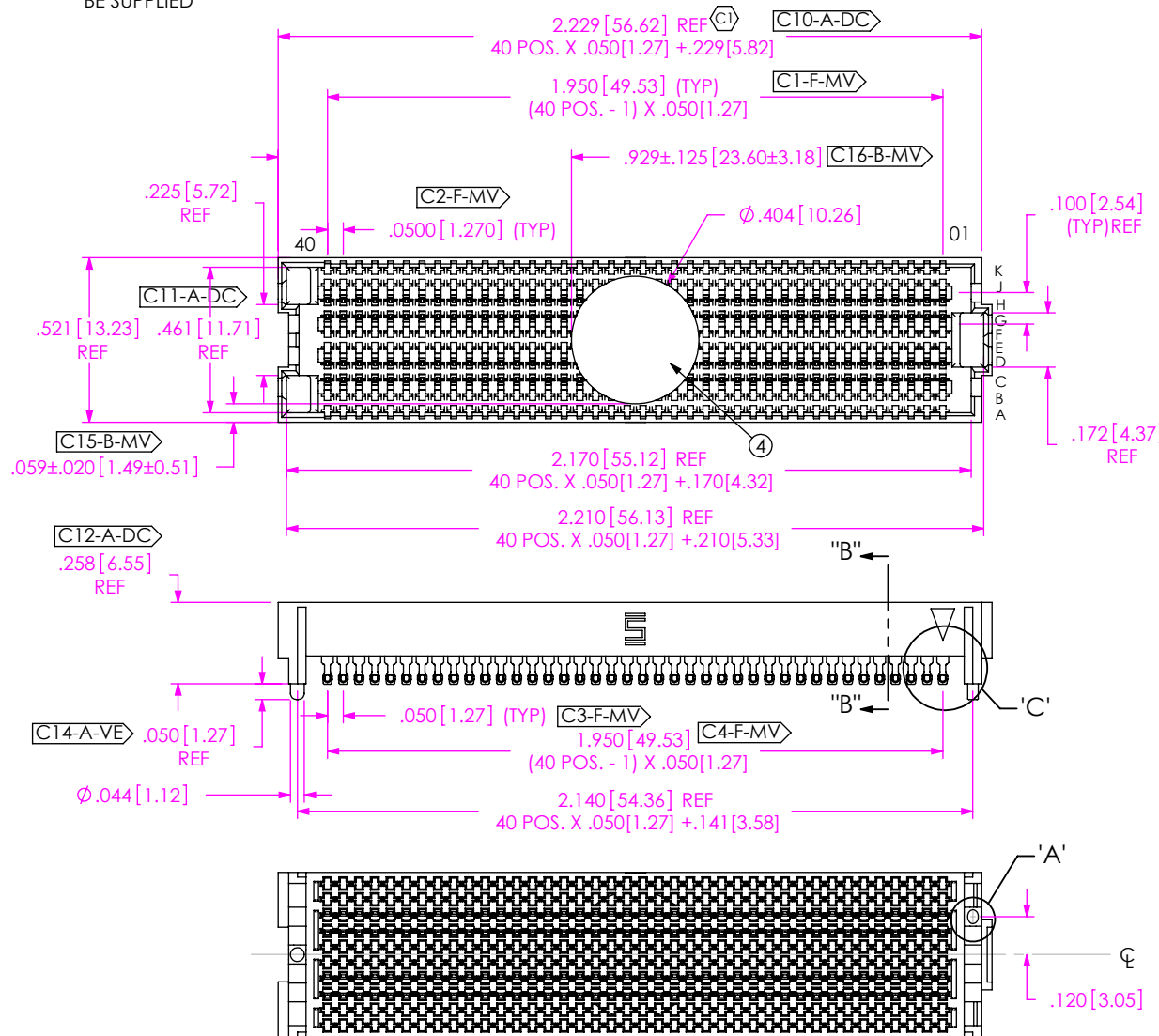

ACCEPTANCE OF DRAWING
ACCEPTED WITH DEVIATIONS LISTED

DATE: _____
 COMPANY: _____
 CUSTOMER SIGNATURE: _____
 PRINTED NAME: _____
 PHONE No.: _____
 FAX No.: _____

| ITEM NO. | PART NUMBER | QUANTITY | MATERIAL |
|----------|----------------------|----------|--------------------------------------|
| 1 | SEAF-40-06.5-10-A | 1.0000 | LCP UL 94 VO, COLOR: BLACK |
| 2 | C-209-06.5-S | 160.00 | BRUSH ALLOY 390 HT |
| 3 | SDT-645-012-02 | 160.00 | SOLDER (95.5% TIN/3.8% /0.7% COPPER) |
| 4 | K-DOT-.404-.500-.005 | 1.0000 | POLYIMIDE FILM |
| 5 | CT-SEAF028MS | 1.0000 | CONDUCTIVE POLYMER |

UNLESS OTHERWISE SPECIFIED, DIMENSIONS ARE IN INCHES. TOLERANCES ARE:
 DECIMALS ANGLES
 .XX: ±.01 [.3] 2°
 .XXX: ±.005 [.13]
 .XXXX: ±.0020 [.051]

PROPRIETARY NOTE
 THIS DOCUMENT CONTAINS INFORMATION CONFIDENTIAL AND PROPRIETARY TO SAMTEC, INC. AND SHALL NOT BE REPRODUCED OR TRANSFERRED TO OTHER DOCUMENTS OR DISCLOSED TO OTHERS OR USED FOR ANY PURPOSE OTHER THAN THAT WHICH IT WAS OBTAINED WITHOUT THE EXPRESSED WRITTEN CONSENT OF SAMTEC, INC.

DO NOT SCALE DRAWING SHEET SCALE: 1:0.333333

PLATING:
 CONTACT AREA: .000030 GOLD OVER .000050 NICKEL
 REMAINDER: .000200 REF TIN OVER .000050 NICKEL

F:\DWG\MISC\MKTG\ASP-134603-01-MKT.SLDDRW

samtec

520 PARK EAST BLVD, NEW ALBANY, IN 47150
 PHONE: 812-944-6733 FAX: 812-948-5047
 e-Mail: info@SAMTEC.com code: 55322

DESCRIPTION:
 .050 PITCH SOCKET ARRAY ASSEMBLY

DWG. NO. ASP-134603-01

Free Datasheet <http://www.samtec.com/>

BY: S. SELLE 10/31/2007 SHEET 1 OF 4

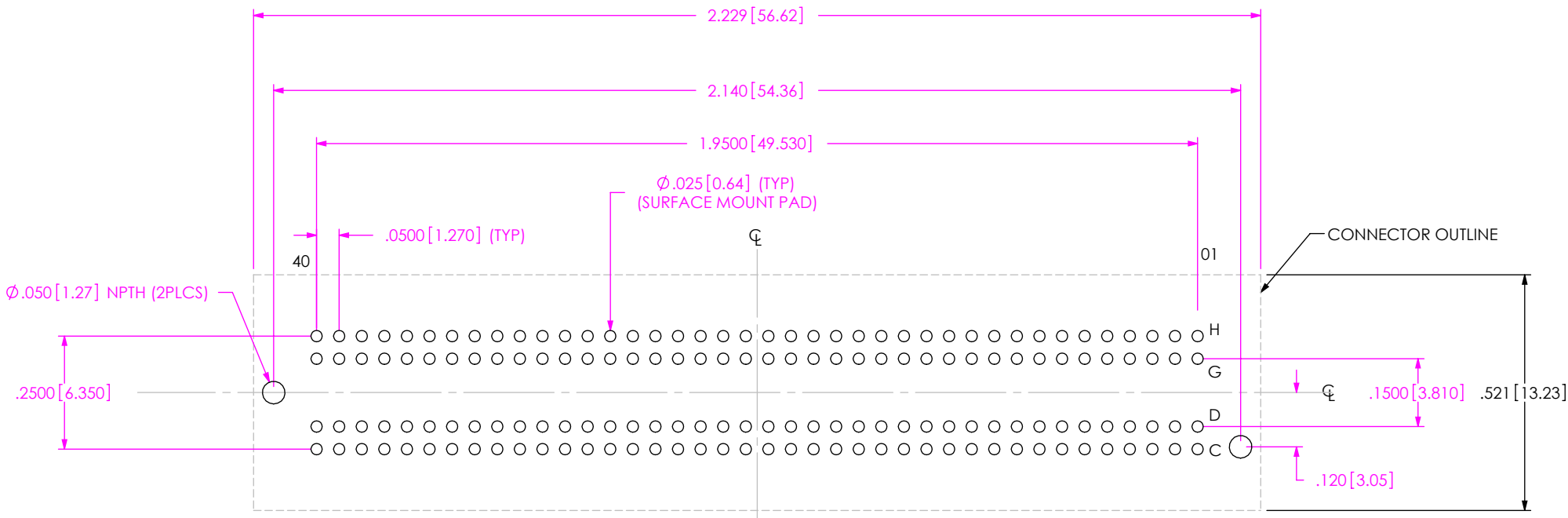

(ALL DIMENSIONS SYMMETRIC ABOUT THE CENTERLINE)

PROPRIETARY NOTE

THIS DOCUMENT CONTAINS INFORMATION CONFIDENTIAL AND PROPRIETARY TO SAMTEC, INC. AND SHALL NOT BE REPRODUCED OR TRANSFERRED TO OTHER DOCUMENTS OR DISCLOSED TO OTHERS OR USED FOR ANY PURPOSE OTHER THAN THAT WHICH IT WAS OBTAINED WITHOUT THE EXPRESSED WRITTEN CONSENT OF SAMTEC, INC.



520 PARK EAST BLVD., NEW ALBANY, IN 47150
 PHONE: 812-944-6733 FAX: 812-948-5047
 e-Mail: info@SAMTEC.com code: 55322

SHEET SCALE: 1:1

DESCRIPTION:
 .050 PITCH SOCKET ARRAY ASSEMBLY

DWG. NO. ASP-134603-01

Free Datasheet <http://www.samtec.com/>

NOTE:
STENCIL TO BE .006[.15] THICK

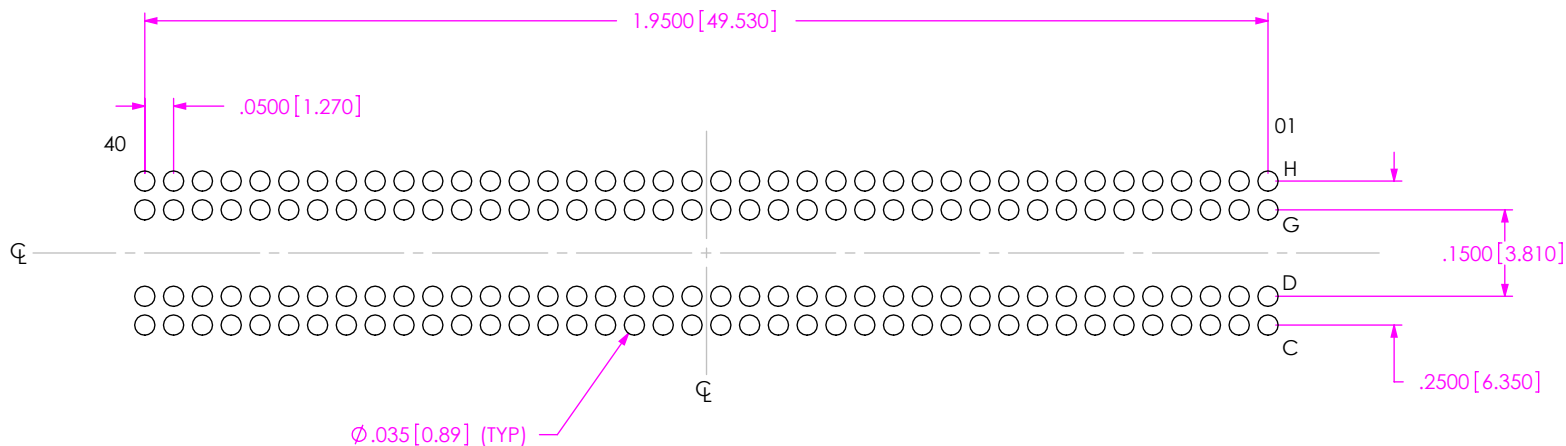

(ALL DIMENSIONS SYMMETRIC ABOUT THE CENTERLINE)

PROPRIETARY NOTE

THIS DOCUMENT CONTAINS INFORMATION CONFIDENTIAL AND PROPRIETARY TO SAMTEC, INC. AND SHALL NOT BE REPRODUCED OR TRANSFERRED TO OTHER DOCUMENTS OR DISCLOSED TO OTHERS OR USED FOR ANY PURPOSE OTHER THAN THAT WHICH IT WAS OBTAINED WITHOUT THE EXPRESSED WRITTEN CONSENT OF SAMTEC, INC.



520 PARK EAST BLVD., NEW ALBANY, IN 47150
PHONE: 812-944-6733 FAX: 812-948-5047
e-Mail: info@SAMTEC.com code: 55322

SHEET SCALE: 1:1

DESCRIPTION:
.050 PITCH SOCKET ARRAY ASSEMBLY

DWG. NO. ASP-134603-01
Free Datasheet <http://www.samtec.com>

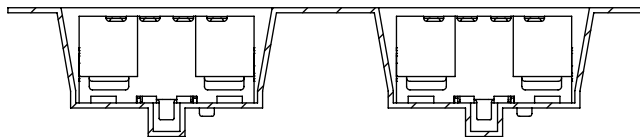
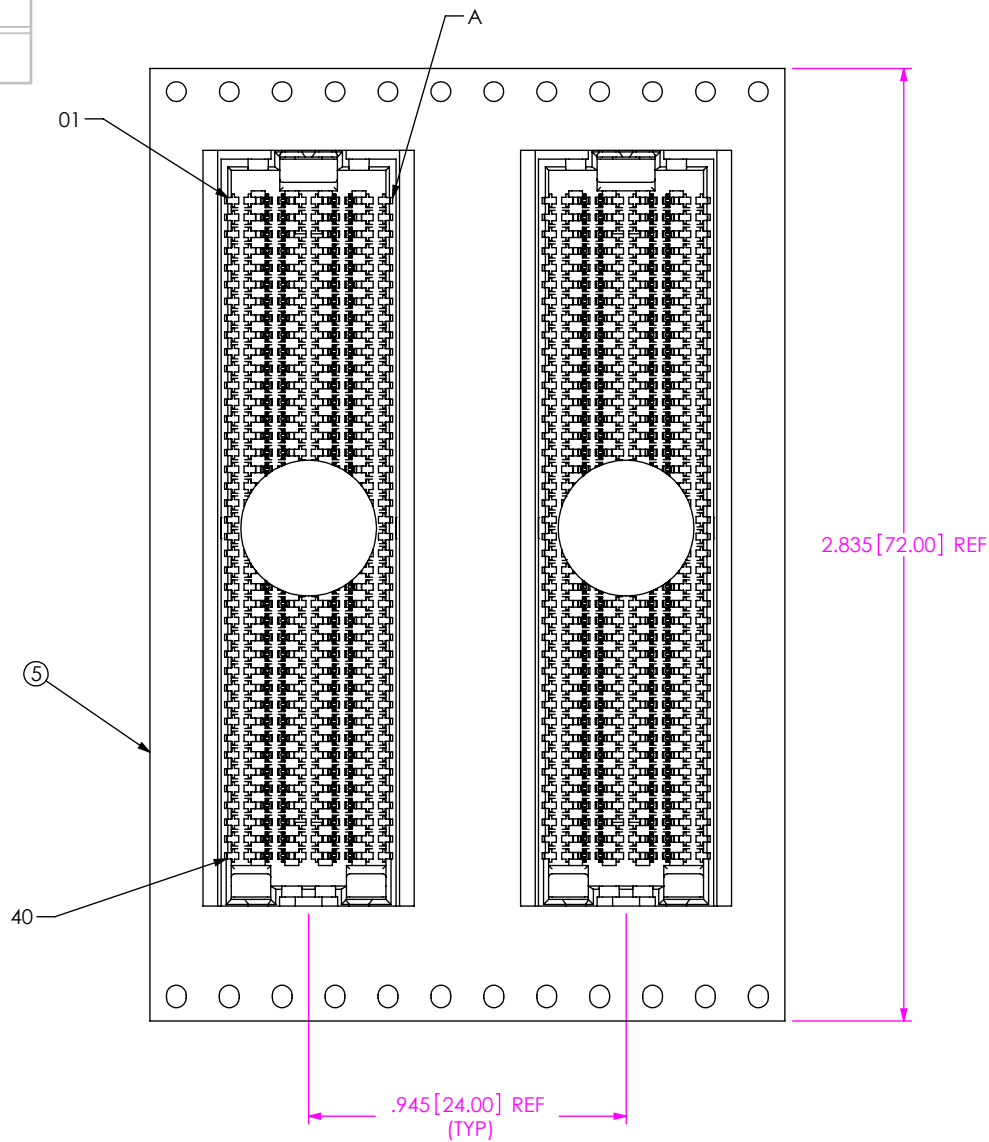

USER DIRECTION OF UNREELING →
POCKET NOT DETAILED

PACKAGING VIEW

PROPRIETARY NOTE

THIS DOCUMENT CONTAINS INFORMATION CONFIDENTIAL AND PROPRIETARY TO SAMTEC, INC. AND SHALL NOT BE REPRODUCED OR TRANSFERRED TO OTHER DOCUMENTS OR DISCLOSED TO OTHERS OR USED FOR ANY PURPOSE OTHER THAN THAT WHICH IT WAS OBTAINED WITHOUT THE EXPRESSED WRITTEN CONSENT OF SAMTEC, INC.



520 PARK EAST BLVD, NEW ALBANY, IN 47150
PHONE: 812-944-6733 FAX: 812-948-5047
e-Mail: info@SAMTEC.com code: 55322

SHEET SCALE: 1:2

DESCRIPTION:
.050 PITCH SOCKET ARRAY ASSEMBLY

DWG. NO. ASP-134603-01
Free Datasheet <http://www.samtec.com/>