

Voltage Variable Absorptive Attenuator, 30 dB 0.5 - 2 GHz

AT-110

V 2.00

Features

- Single Positive Voltage Control 0 to +5 Volts
- 30 dB Voltage Variable Attenuation
- ± 2 dB Linearity from BSL
- Low DC Power Consumption
- Temperature Range: -40°C to $+85^{\circ}\text{C}$
- Low-Cost SOIC 8 Plastic Package
- Tape and Reel Packaging Available
- Fast Switching Speed

Description

M/A-COM's AT-110 is a linear GaAs MMIC voltage variable absorptive attenuator in a low-cost SOIC 8-lead surface mount plastic package. The AT-110 has a faster switching speed than the AT-108 or AT-109. The AT-110 is ideally suited for use where linear attenuation fine tuning and very low power consumption are required. Typical applications include radio, cellular, GPS equipment and automatic gain/level control circuits.

The AT-110 is fabricated with a monolithic GaAs MMIC using a mature 1-micron process. The process features full chip passivation for increased performance and reliability.

Typical Electrical Specifications¹, $T_A = +25^{\circ}\text{C}$

Parameter	Test Conditions	Units	Min.	Typ.	Max.
Insertion Loss	0.5 - 1.0 GHz	dB		2.8	3.0
	1.0 - 2.0 GHz	dB		3.3	3.6
Attenuation	0.5 - 16 GHz	dB	30		
	1.0 - 26 GHz	dB	25		
Flatness (Peak-to-Peak)	0.5 - 1.0 GHz	dB		± 0.5	± 0.8
	1.0 - 2.0 GHz	dB		± 1.2	± 1.5
VSWR				2:1	
Trise, Tfall	10% to 90% RF, 90% to 10% RF	μS		0.2	
Ton, Toff	50% Control to 90% RF, Control to 10% RF	μS		0.2	
Transients	In-band	mV		70	

1. All measurements at 1 GHz in a 50- Ω system, unless otherwise specified. The RF ports must be blocked outside of the package from ground or any other voltage.

SO-8

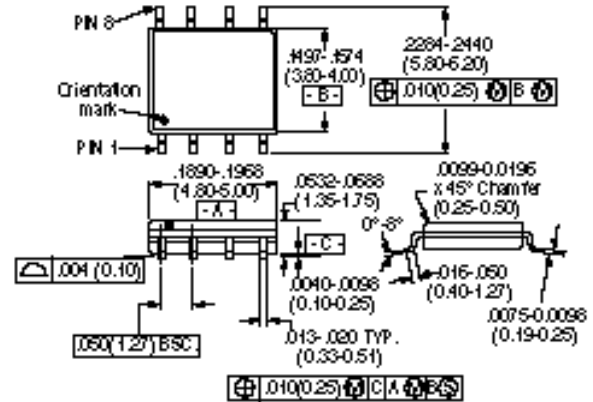

8-Lead SOP outline dimensions
Narrow body .150
(All dimensions per JEDEC No. MS-012-AA, Issue C)
Dimensions in () are in mm.
Unless Otherwise Noted: xxx = ± 0.010 (xxx = ± 0.25)
xxx = ± 0.02 (x = ± 0.5)

Ordering Information

Part Number	Package
AT-110	SOIC 8-Lead Plastic Package
AT-110TR	Forward Tape & Reel*
AT-110RTR	Reverse Tape & Reel*

* If specific reel size is required, consult factory for part number assignment.

Absolute Maximum Ratings 1

Parameter	Absolute Maximum
Maximum Input Power	+21 dBm
Supply Voltage V_{CC}	-1 V, +8 V
Control Voltage V_C	-1 V, $V_{CC} + 0.5$ V
Operating Temperature	-40°C to +85°C
Storage Temperature	-65°C to +150°C

1. Operation of this device above any one of these parameters may cause permanent damage.

Functional Schematic

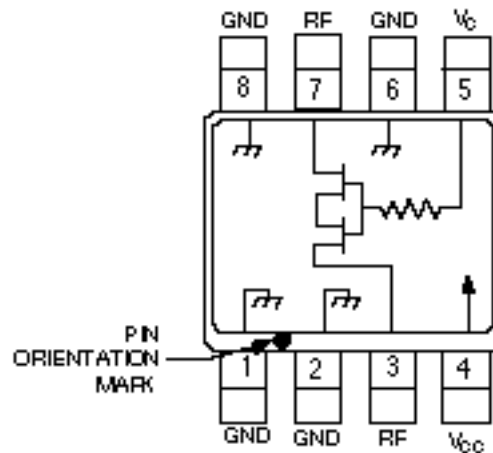

$V_{CC} = +5$ VDC \pm 0.5 VDC @ 300 μ A max.

$V_C = 0$ VDC to +5 VDC @ 6 mA max.

External DC blocking capacitors are required on all RF ports.

Typical Performance

RELATIVE ATTENUATION vs CONTROL VOLTAGE
@ +25°C, F = 1800 MHz

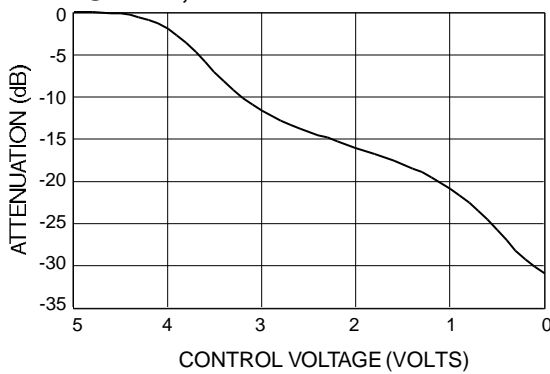

INSERTION LOSS vs FREQUENCY

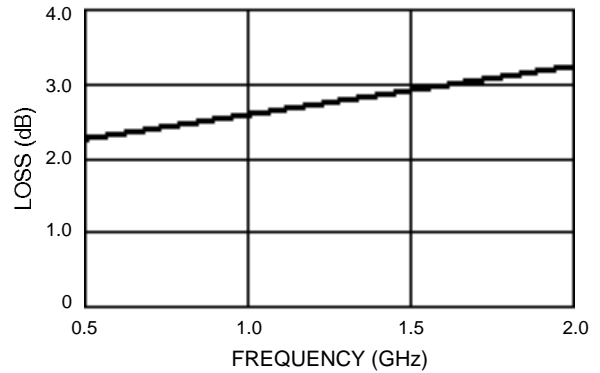

ATTENUATION vs CONTROL VOLTAGE
@ +25°C, F = 900 MHz

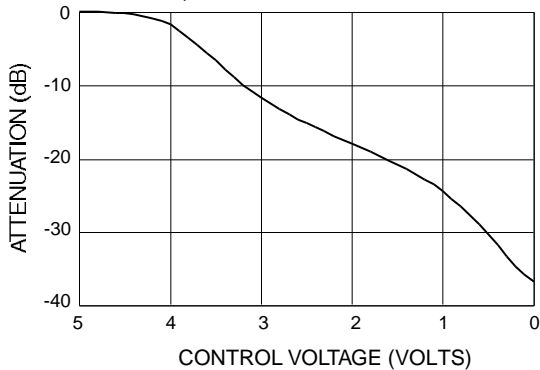

ATTENUATION vs TEMPERATURE, NORMALIZED TO +25°C, F = 900 MHz

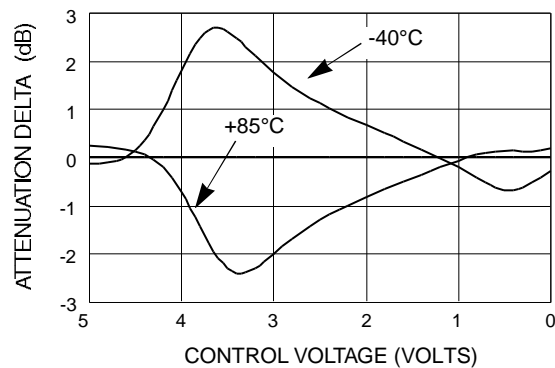

RETURN LOSS vs CONTROL VOLTAGE
@ +25°C, F = 900 MHz

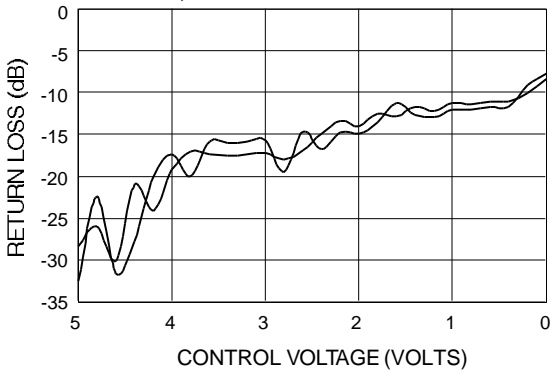

1dB COMPRESSION vs CONTROL VOLTAGE
@ +25°C, F = 900 MHz

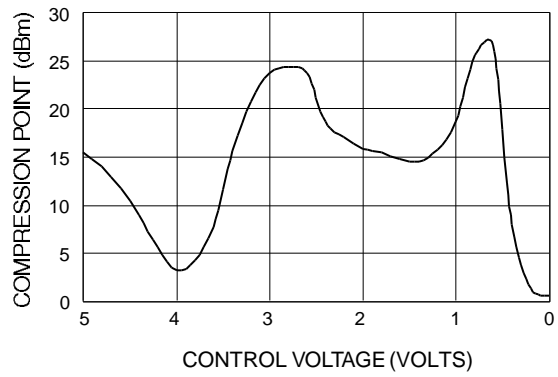

IP₃ vs CONTROL VOLTAGE

