

AT-32032

Low Current, High Performance
NPN Silicon Bipolar Transistor



Data Sheet



Description

Avago's AT-32032 is a high performance NPN bipolar transistor that has been optimized for maximum f_t at low voltage operation, making it ideal for use in battery powered applications in cellular/PCS and other wireless markets. The AT-32032 uses the miniature 3 lead SOT-323 (SC-70) plastic package.

Optimized performance at 2.7 V makes this device ideal for use in 900 MHz, 1.8 GHz, and 2.4 GHz systems. Typical amplifier design at 900 MHz yields 1 dB noise figures with 15 dB associated gain at 2.7 V and 5 mA bias condition, with noise performance being relatively insensitive to input match. High gain capability at 1 V and 1 mA makes this device a good fit for 900 MHz pager applications. Moreover, voltage breakdown is high enough for use at 5 V.

The AT-32032 belongs to Avago's AT-3XXXX series bipolar transistors. It exhibits excellent device uniformity, performance and reliability as a result of ion-implantation, self-alignment techniques, and gold metalization in the fabrication process.

Features

- High Performance Bipolar Transistor Optimized for Low Current, Low Voltage Applications at 900 MHz, 1.8 GHz, and 2.4 GHz
- Performance at 2.7 V, 5 mA:
900 MHz: 1 dB NF, 15 dB G_A
1800 MHz: 1.3 dB NF, 11 dB G_A
2400 MHz: 1.4 dB NF, 7.5 dB G
- Characterized for End-Of-Life Battery Use (2.7 V)
- Miniature 3-lead SOT-323 (SC-70) Plastic Package
- Lead-free

Applications

- LNA, Oscillator, Driver Amplifier, Buffer Amplifier, and Down Converter for Cellular and PCS Handsets and Cordless Telephones
- LNA, Oscillator, Mixer, and Gain Amplifier for Pagers
- Power Amplifier and Oscillator for RF-ID Tag
- LNA and Gain Amplifier for GPS
- LNA for CATV Set-Top Box

3-Lead SC-70 (SOT-323)

Surface Mount Plastic Package

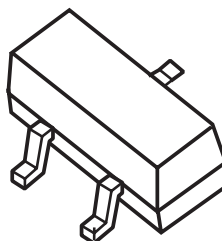

Pin Configuration

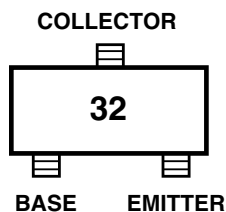

AT-32032 Absolute Maximum Ratings

Symbol	Parameter	Units	Absolute Maximum ^[1]
V _{EBO}	Emitter-Base Voltage	V	1.5
V _{CBO}	Collector-Base Voltage	V	11
V _{CEO}	Collector-Emitter Voltage	V	5.5
I _C	Collector Current	mA	40
P _T	Power Dissipation ^[2, 3]	mW	200
T _j	Junction Temperature	°C	150
T _{STG}	Storage Temperature	°C	-65 to 150

Thermal Resistance^{[2]:}
 $\theta_{jc} = 350^{\circ}\text{C}/\text{W}$

Notes:

1. Operation of this device above any one of these parameters may cause permanent damage.
2. T_{MOUNTING SURFACE} = 25°C.
3. Derate at 2.86 mW/°C for T_{MOUNTING SURFACE} > 80°C.

Electrical Specifications, T_A = 25°C

Symbol	Parameters and Test Conditions	Units	Min.	Typ.	Max.
NF	Noise Figure V _{CE} = 2.7 V, I _C = 5 mA	f = 0.9 GHz f = 1.8 GHz		1.0 1.25	1.3
G _A	Associated Gain V _{CE} = 2.7 V, I _C = 5 mA	f = 0.9 GHz f = 1.8 GHz	13.5	15.0 10.5	
h _{FE}	Forward Current Transfer Ratio V _{CE} = 2.7 V, I _C = 5 mA	–	70		300
I _{CBO}	Collector Cutoff Current V _{CB} = 3 V	μA			0.2
I _{EBO}	Emitter Cutoff Current V _{EB} = 1 V	μA			1.5

AT-32032 Characterization Information, T_A = 25°C

Symbol	Parameters and Test Conditions	Units	Typ.
P _{1dB}	Power at 1 dB Gain Compression (opt tuning) V _{CE} = 2.7 V, I _C = 20 mA	f = 0.9 GHz	dBm
G _{1dB}	Gain at 1 dB Gain Compression (opt tuning) V _{CE} = 2.7 V, I _C = 20 mA	f = 0.9 GHz	dB
IP ₃	Output Third Order Intercept Point (opt tuning) V _{CE} = 2.7 V, I _C = 20 mA	f = 0.9 GHz	dBm
S ₂₁ ²	Gain in 50 Ω System V _{CE} = 2.7 V, I _C = 2 mA	f = 0.9 GHz	dB

AT-32032 Typical Performance

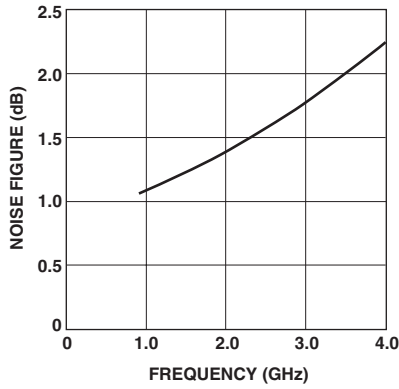

Figure 1. AT-32032 Typical Noise Figure vs. Frequency at 1V, 1 mA.

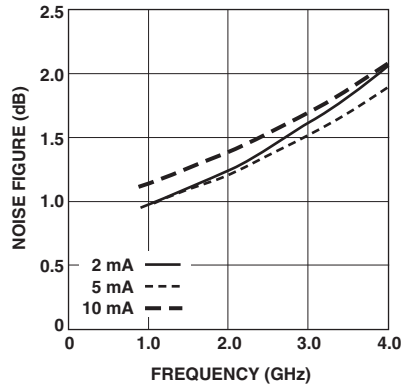

Figure 2. AT-32032 Typical Noise Figure vs. Frequency and Current at 2.7V.

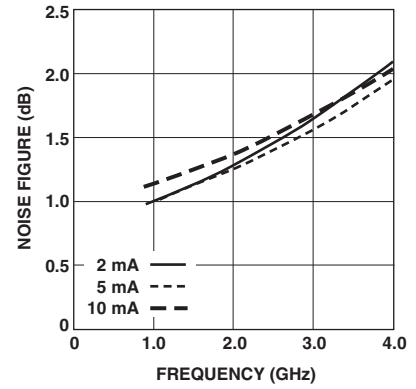

Figure 3. AT-32032 Typical Noise Figure vs. Frequency and Current at 5V.

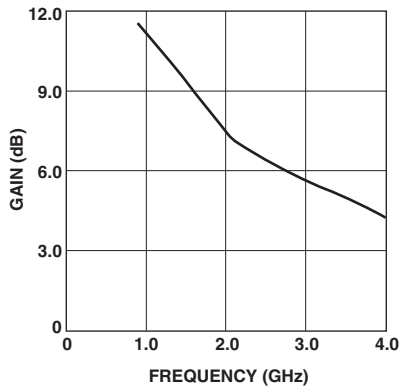

Figure 4. AT-32032 Associated Gain vs. Frequency at 1V, 1 mA.

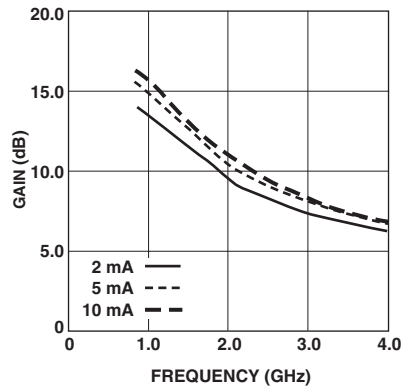

Figure 5. AT-32032 Associated Gain vs. Frequency and Current at 2.7V.

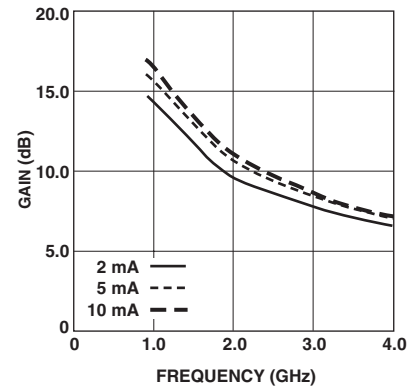

Figure 6. AT-32032 Associated Gain vs. Frequency and Current at 5V.

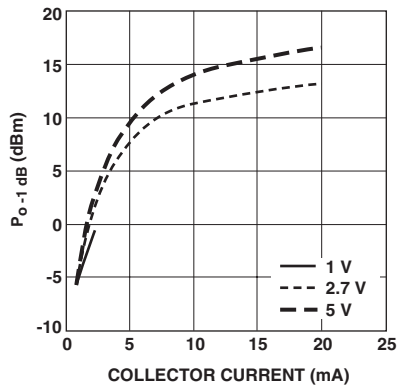

Figure 7. AT-32032 $P_{1\text{ dB}}$ vs. Collector Current and Voltage (valid up to 2.4 GHz).

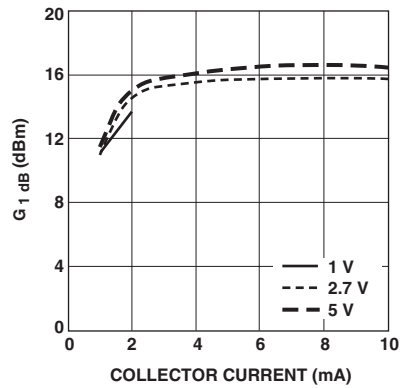

Figure 8a. $G_{1\text{ dB}}$ vs. Collector Current and Voltage (at 900 MHz).

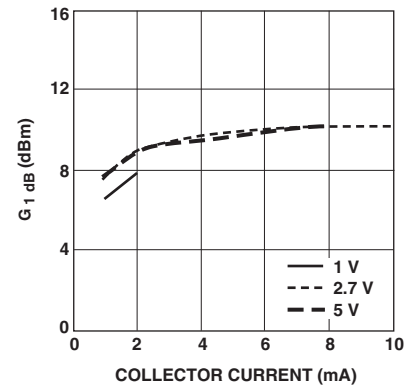

Figure 8b. $G_{1\text{ dB}}$ vs. Collector Current and Voltage (at 1.8 GHz).

AT-32032 Typical Scattering Parameters, Common Emitter, $Z_O = 50 \Omega$, $V_{CE} = 1 \text{ V}$, $I_C = 1 \text{ mA}$

Freq. GHz	S ₁₁			S ₂₁			S ₁₂		S ₂₂	
	Mag	Ang	dB	Mag	Ang	dB	Mag	Ang	Mag	Ang
0.5	0.852	-51	9.61	3.024	137	-20.65	0.093	59	0.895	-21
0.75	0.760	-74	8.68	2.717	119	-18.39	0.120	48	0.821	-29
1.0	0.655	-94	7.68	2.420	104	-17.35	0.136	40	0.756	-35
1.5	0.523	-130	5.75	1.939	79	-16.68	0.147	32	0.665	-44
2.0	0.451	-161	4.11	1.606	60	-16.52	0.149	31	0.615	-52
3.0	0.403	147	1.76	1.224	30	-14.42	0.190	43	0.565	-71
4.0	0.419	104	0.20	1.023	7	-10.21	0.309	42	0.527	-96
5.0	0.459	69	-0.92	0.899	-11	-6.58	0.469	26	0.478	-127
6.0	0.497	45	-1.56	0.836	-26	-4.22	0.615	5	0.411	-168
7.0	0.529	27	-1.84	0.809	-41	-2.85	0.720	-18	0.379	141
8.0	0.561	13	-2.07	0.788	-56	-2.33	0.765	-40	0.425	96
9.0	0.590	-2	-2.34	0.764	-72	-2.28	0.769	-60	0.495	63
10.0	0.626	-17	-2.74	0.729	-87	-2.57	0.744	-79	0.555	38

AT-32032 Typical Noise Parameters,

Common Emitter, $Z_O = 50 \Omega$, $V_{CE} = 1 \text{ V}$, $I_C = 1 \text{ mA}$

Freq. GHz	F _{min} dB	Γ _{opt}		R _n ohms	G _{assoc} dB
		Mag	Ang		
0.9	1.1	0.48	63	14.5	11.5
1.8	1.3	0.51	129	6.8	8.3
2.0	1.4	0.52	143	5.2	7.4
2.5	1.6	0.54	177	2.9	6.4
3.0	1.8	0.57	-153	4.9	5.7
3.5	2.0	0.61	-125	12.7	5.0
4.0	2.2	0.65	-102	26.0	4.2

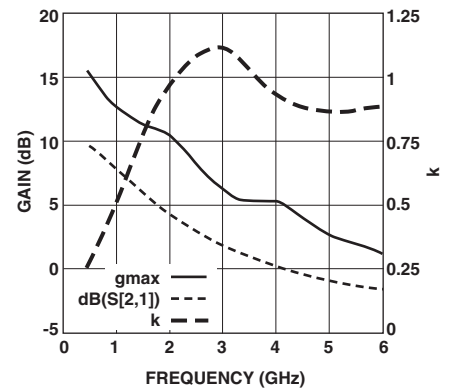

Figure 9. Gain vs. Frequency at 1 V, 1 mA.

Note: $\text{dB}(|S_{21}|) = 20 * \log(|S_{21}|)$

g_{max} = maximum available gain (MAG) if $k > 1$

g_{max} = maximum stable gain (MSG) if $k < 1$

k = stability factor

$$\text{MAG} = \left| \frac{S_{21}}{S_{12}} \right| (k \pm \sqrt{k^2 - 1})$$

$$\text{MSG} = |S_{21}| / |S_{12}|$$

$$k = \frac{1 - |S_{11}|^2 - |S_{22}|^2 + |D|^2}{2 * |S_{12}| |S_{21}|}; D = S_{11}S_{22} - S_{12}S_{21}$$

AT-32032 Typical Scattering Parameters, Common Emitter, $Z_O = 50 \Omega$, $V_{CE} = 2.7 \text{ V}$, $I_C = 2 \text{ mA}$

Freq. GHz	S_{11}			S_{21}			S_{12}		S_{22}	
	Mag	Ang	dB	Mag	Ang	dB	Mag	Ang	Mag	Ang
0.5	0.744	-57	14.37	5.232	130	-23.72	0.065	60	0.839	-22
0.75	0.609	-78	12.86	4.394	112	-21.73	0.082	52	0.755	-28
1.0	0.489	-96	11.40	3.714	98	-20.58	0.094	49	0.694	-31
1.5	0.351	-129	8.86	2.774	77	-19.05	0.112	48	0.625	-37
2.0	0.280	-158	6.93	2.221	61	-17.56	0.133	49	0.592	-43
3.0	0.236	149	4.28	1.636	34	-14.08	0.198	50	0.561	-59
4.0	0.258	105	2.58	1.346	11	-10.62	0.295	44	0.541	-78
5.0	0.317	72	1.36	1.170	-8	-7.54	0.420	30	0.510	-103
6.0	0.387	51	0.43	1.051	-26	-5.11	0.555	13	0.447	-135
7.0	0.455	34	-0.24	0.973	-42	-3.28	0.686	-8	0.373	-178
8.0	0.516	19	-0.80	0.913	-58	-2.24	0.772	-30	0.367	129
9.0	0.563	3	-1.39	0.852	-74	-1.86	0.807	-52	0.431	86
10.0	0.610	-14	-2.00	0.794	-89	-2.00	0.795	-73	0.504	55

AT-32032 Typical Noise Parameters,

Common Emitter, $Z_O = 50 \Omega$, $V_{CE} = 2.7 \text{ V}$, $I_C = 2 \text{ mA}$

Freq. GHz	F_{min} dB	Γ_{opt}		R_n ohms	G_{assoc} dB
		Mag	Ang		
0.9	0.9	0.38	57	10.6	14.0
1.8	1.2	0.41	124	6.2	10.5
2.0	1.2	0.42	136	5.3	9.4
2.5	1.4	0.44	176	3.4	8.4
3.0	1.6	0.47	-152	4.9	7.5
3.5	1.8	0.52	-123	10.5	6.9
4.0	2.1	0.57	-100	20.6	6.2

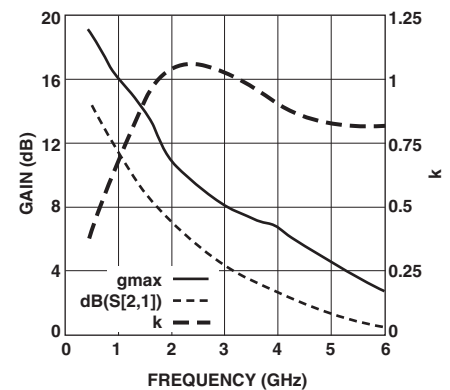

Figure 10. Gain vs. Frequency at 2.7 V, 2 mA.

Note: $\text{dB}(|S_{21}|) = 20 * \log(|S_{21}|)$

g_{max} = maximum available gain (MAG) if $k > 1$

g_{max} = maximum stable gain (MSG) if $k < 1$

k = stability factor

$$\text{MAG} = \left| \frac{S_{21}}{S_{12}} \right| (k \pm \sqrt{k^2 - 1})$$

$$\text{MSG} = |S_{21}| / |S_{12}|$$

$$k = \frac{1 - |S_{11}|^2 - |S_{22}|^2 + |D|^2}{2 * |S_{12}| |S_{21}|}; D = S_{11}S_{22} - S_{12}S_{21}$$

AT-32032 Typical Scattering Parameters, Common Emitter, $Z_0 = 50 \Omega$, $V_{CE} = 2.7 \text{ V}$, $I_C = 5 \text{ mA}$

Freq. GHz	S_{11}			S_{21}			S_{12}		S_{22}	
	Mag	Ang	dB	Mag	Ang	dB	Mag	Ang	Mag	Ang
0.5	0.484	-70	18.65	8.559	113	-25.51	0.053	62	0.680	-26
0.75	0.344	-88	16.04	6.339	98	-23.25	0.069	61	0.602	-28
1.0	0.257	-103	13.98	5.000	87	-21.46	0.085	61	0.561	-29
1.5	0.165	-130	10.90	3.509	70	-18.59	0.118	60	0.522	-33
2.0	0.124	-160	8.76	2.740	57	-16.29	0.153	57	0.502	-39
3.0	0.112	143	5.93	1.979	33	-12.69	0.232	48	0.477	-55
4.0	0.144	100	4.19	1.620	13	-9.89	0.320	37	0.454	-73
5.0	0.209	72	3.01	1.414	-7	-7.55	0.419	24	0.418	-95
6.0	0.296	57	2.14	1.279	-25	-5.58	0.526	8	0.353	-124
7.0	0.394	43	1.43	1.179	-43	-3.94	0.636	-10	0.275	-166
8.0	0.489	28	0.70	1.084	-61	-2.79	0.725	-30	0.270	137
9.0	0.564	10	-0.12	0.986	-78	-2.18	0.778	-50	0.355	91
10.0	0.627	-9	-1.05	0.886	-94	-2.10	0.786	-71	0.455	58

AT-32032 Typical Noise Parameters,

Common Emitter, $Z_0 = 50 \Omega$, $V_{CE} = 2.7 \text{ V}$, $I_C = 5 \text{ mA}$

Freq. GHz	F_{min} dB	Γ_{opt}		R_n ohms	G_{assoc} dB
		Mag	Ang		
0.9	0.9	0.23	71	7.5	15.6
1.8	1.2	0.295	138	5.1	11.5
2.0	1.2	0.31	152	4.6	10.4
2.5	1.3	0.35	-173	4.1	9.1
3.0	1.5	0.41	-142	5.8	8.2
3.5	1.7	0.47	-114	11.0	7.4
4.0	1.9	0.54	-93	20.0	6.7

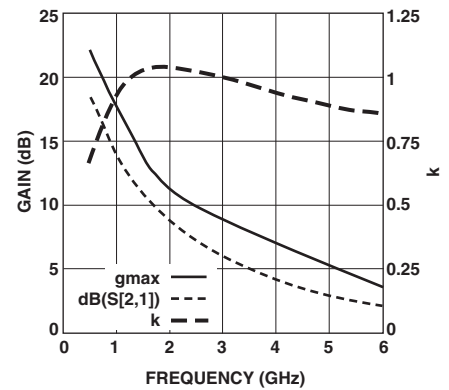

Figure 11. Gain vs. Frequency at 2.7 V, 5 mA.

Note: $\text{dB}(|S_{21}|) = 20 * \log(|S_{21}|)$

g_{max} = maximum available gain (MAG) if $k > 1$

g_{max} = maximum stable gain (MSG) if $k < 1$

k = stability factor

$$\text{MAG} = \left| \frac{S_{21}}{S_{12}} \right| (k \pm \sqrt{k^2 - 1})$$

$$\text{MSG} = |S_{21}| / |S_{12}|$$

$$k = \frac{1 - |S_{11}|^2 - |S_{22}|^2 + |D|^2}{2 * |S_{12}| |S_{21}|}; D = S_{11}S_{22} - S_{12}S_{21}$$

AT-32032 Typical Scattering Parameters, Common Emitter, $Z_O = 50 \Omega$, $V_{CE} = 2.7 V$, $I_C = 10 mA$

Freq. GHz	S_{11}			S_{21}			S_{12}		S_{22}	
	Mag	Ang	dB	Mag	Ang	dB	Mag	Ang	Mag	Ang
0.5	0.292	-76.768	20.197	10.230	102.252	-26.558	0.047	68.475	0.577	-23.850
0.75	0.194	-89.611	17.121	7.179	90.014	-23.688	0.065	68.467	0.528	-24.315
1.0	0.139	-100.612	14.850	5.527	81.084	-21.463	0.085	67.769	0.504	-25.449
1.5	0.081	-126.165	11.624	3.813	66.997	-18.160	0.124	64.256	0.481	-30.013
2.0	0.057	-160.808	9.409	2.954	54.862	-15.735	0.163	59.458	0.467	-36.600
3.0	0.064	131.034	6.523	2.119	33.080	-12.174	0.246	48.003	0.443	-52.023
4.0	0.103	91.686	4.750	1.728	13.099	-9.551	0.333	35.089	0.418	-70.196
5.0	0.169	69.993	3.580	1.510	-5.823	-7.424	0.425	21.009	0.378	-92.177
6.0	0.258	58.339	2.719	1.368	-24.160	-5.668	0.521	5.600	0.309	-119.643
7.0	0.362	46.145	2.042	1.265	-42.430	-4.173	0.619	-11.469	0.224	-160.597
8.0	0.466	31.083	1.334	1.166	-60.668	-3.083	0.701	-30.211	0.217	138.234
9.0	0.553	13.235	0.533	1.063	-78.273	-2.402	0.758	-50.020	0.307	91.480
10.0	0.628	-5.840	-0.404	0.955	-95.268	-2.236	0.773	-69.960	0.419	58.813

AT-32032 Typical Noise Parameters,

Common Emitter, $Z_O = 50 \Omega$, $V_{CE} = 2.7 V$, $I_C = 10 mA$

Freq. GHz	F_{min} dB	Γ_{opt}		R_n ohms	G_{assoc} dB
		Mag	Ang		
0.9	1.1	0.15	87	7.6	16.2
1.8	1.3	0.23	159	5.6	11.9
2.0	1.4	0.26	173	5.3	11.0
2.5	1.5	0.32	-156	5.7	9.5
3.0	1.7	0.38	-128	8.6	8.4
3.5	1.9	0.45	-105	14.8	7.6
4.0	2.0	0.52	-84	25.0	6.8

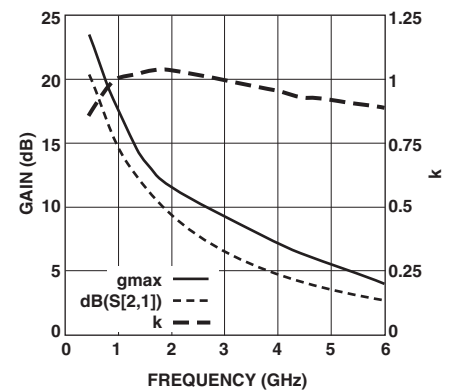

Figure 12. Gain vs. Frequency at 2.7 V, 10 mA.

Note: $dB(|S_{21}|) = 20 * \log(|S_{21}|)$

g_{max} = maximum available gain (MAG) if $k > 1$

g_{max} = maximum stable gain (MSG) if $k < 1$

k = stability factor

$$MAG = \left| \frac{S_{21}}{S_{12}} \right| (k \pm \sqrt{k^2 - 1})$$

$$MSG = |S_{21}| / |S_{12}|$$

$$k = \frac{1 - |S_{11}|^2 - |S_{22}|^2 + |D|^2}{2 * |S_{12}| |S_{21}|}; D = S_{11}S_{22} - S_{12}S_{21}$$

AT-32032 Typical Scattering Parameters, Common Emitter, $Z_O = 50 \Omega$, $V_{CE} = 5 \text{ V}$, $I_C = 2 \text{ mA}$

Freq. GHz	S_{11}			S_{21}			S_{12}		S_{22}	
	Mag	Ang	dB	Mag	Ang	dB	Mag	Ang	Mag	Ang
0.1	0.940	-13	17.5	7.500	167	-36.0	0.016	83	0.981	-5
0.5	0.732	-56	14.9	5.588	129	-23.8	0.064	60	0.842	-22
0.9	0.518	-87	12.4	4.165	104	-21.1	0.088	51	0.714	-29
1.0	0.484	-93	11.6	3.814	99	-20.6	0.093	50	0.699	-30
1.5	0.342	-124	9.0	2.824	78	-19.0	0.112	49	0.632	-36
1.8	0.291	-142	7.8	2.466	67	-18.1	0.125	49	0.606	-40
2.0	0.265	-153	7.1	2.267	61	-17.5	0.134	50	0.596	-43
3.0	0.212	151	4.5	1.670	34	-14.0	0.199	50	0.566	-58
4.0	0.238	103	2.7	1.367	11	-10.7	0.293	43	0.549	-77
5.0	0.306	70	1.5	1.186	-8	-7.6	0.416	30	0.515	-102
6.0	0.383	50	0.6	1.067	-26	-5.2	0.550	13	0.453	-134
7.0	0.456	34	-0.1	0.990	-43	-3.3	0.682	-8	0.375	-177
8.0	0.523	19	-0.7	0.918	-59	-2.3	0.771	-31	0.373	130
9.0	0.573	2	-1.3	0.857	-75	-1.9	0.805	-53	0.437	86
10.0	0.620	-14	-2.0	0.792	-90	-2.0	0.791	-73	0.515	54

AT-32032 Typical Noise Parameters,

Common Emitter, $Z_O = 50 \Omega$, $V_{CE} = 5 \text{ V}$, $I_C = 2 \text{ mA}$

Freq. GHz	F_{min} dB	Γ_{opt}		R_n ohms	G_{assoc} dB
		Mag	Ang		
0.9	1.0	0.48	50	14.7	14.8
1.8	1.2	0.445	118	7.4	10.1
2.0	1.3	0.44	134	5.8	9.5
2.5	1.5	0.43	172	3.7	8.5
3.0	1.7	0.47	-154	5.0	7.7
3.5	1.9	0.53	-123	11.3	7.0
4.0	2.1	0.58	-98	23.7	6.4

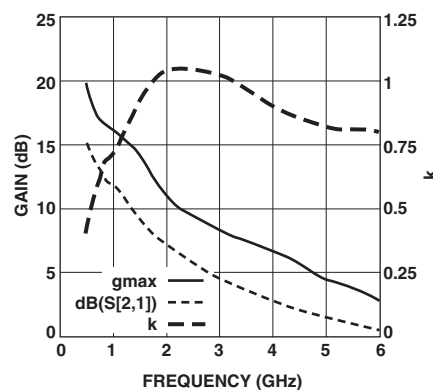

Figure 13. Gain vs. Frequency at 5 V, 2 mA.

Note: $\text{dB}(|S_{21}|) = 20 * \log(|S_{21}|)$

g_{max} = maximum available gain (MAG) if $k > 1$

g_{max} = maximum stable gain (MSG) if $k < 1$

k = stability factor

$$\text{MAG} = \left| \frac{S_{21}}{S_{12}} \right| (k \pm \sqrt{k^2 - 1})$$

$$\text{MSG} = |S_{21}| / |S_{12}|$$

$$k = \frac{1 - |S_{11}|^2 - |S_{22}|^2 + |D|^2}{2 * |S_{12}| |S_{21}|}; D = S_{11}S_{22} - S_{12}S_{21}$$

AT-32032 Typical Scattering Parameters, Common Emitter, $Z_O = 50 \Omega$, $V_{CE} = 5 \text{ V}$, $I_C = 5 \text{ mA}$

Freq. GHz	S ₁₁			S ₂₁			S ₁₂		S ₂₂	
	Mag	Ang	dB	Mag	Ang	dB	Mag	Ang	Mag	Ang
0.1	0.860	-19	23.8	15.523	160	-36.4	0.015	80	0.949	-9
0.5	0.496	-67	18.8	8.705	114	-25.4	0.054	63	0.690	-25
0.9	0.298	-90	14.9	5.569	92	-22.0	0.079	61	0.580	-28
1.0	0.269	-96	14.1	5.067	88	-21.4	0.085	61	0.570	-29
1.5	0.168	-119	11.0	3.558	71	-18.5	0.119	59	0.530	-33
1.8	0.133	-135	9.7	3.046	63	-17.1	0.140	58	0.514	-36
2.0	0.116	-146	8.9	2.782	58	-16.2	0.154	57	0.508	-39
3.0	0.086	150	6.1	2.011	34	-12.7	0.232	48	0.483	-54
4.0	0.121	98	4.3	1.640	13	-9.9	0.319	37	0.461	-72
5.0	0.194	70	3.1	1.434	-6	-7.6	0.417	23	0.422	-95
6.0	0.287	57	2.3	1.300	-25	-5.7	0.521	8	0.354	-124
7.0	0.390	43	1.6	1.198	-44	-4.0	0.631	-10	0.274	-166
8.0	0.491	28	0.8	1.101	-62	-2.8	0.722	-30	0.273	137
9.0	0.570	10	0	0.997	-79	-2.2	0.774	-51	0.361	91
10.0	0.640	-9	-1.0	0.891	-95	-2.1	0.781	-72	0.464	57

AT-32032 Typical Noise Parameters,

Common Emitter, $Z_O = 50 \Omega$, $V_{CE} = 5 \text{ V}$, $I_C = 5 \text{ mA}$

Freq. GHz	F _{min} dB	Γ_{opt}		R _n ohms	G _{assoc} dB
		Mag	Ang		
0.9	1.0	0.38	52	11.7	16.1
1.8	1.2	0.335	124	6.3	11.2
2.0	1.3	0.33	140	5.3	10.5
2.5	1.4	0.35	179	4.3	9.2
3.0	1.6	0.40	-146	5.9	8.2
3.5	1.8	0.47	-118	11.5	7.5
4.0	2.0	0.54	-92	22.0	6.8

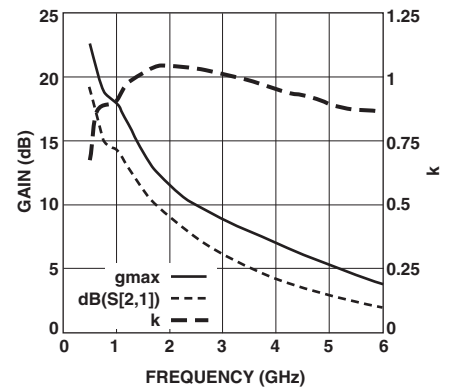

Figure 14. Gain vs. Frequency at 5 V, 5 mA.

Note: $\text{dB}(|S_{21}|) = 20 * \log(|S_{21}|)$

g_{max} = maximum available gain (MAG) if $k > 1$
 g_{max} = maximum stable gain (MSG) if $k < 1$
 k = stability factor

$$\text{MAG} = \left| \frac{S_{21}}{S_{12}} \right| (k \pm \sqrt{k^2 - 1})$$

$$\text{MSG} = |S_{21}| / |S_{12}|$$

$$k = \frac{1 - |S_{11}|^2 - |S_{22}|^2 + |D|^2}{2 * |S_{12}| |S_{21}|}; D = S_{11}S_{22} - S_{12}S_{21}$$

AT-32032 Typical Scattering Parameters, Common Emitter, $Z_O = 50 \Omega$, $V_{CE} = 5 \text{ V}$, $I_C = 10 \text{ mA}$

Freq. GHz	S_{11}			S_{21}			S_{12}		S_{22}	
	Mag	Ang	dB	Mag	Ang	dB	Mag	Ang	Mag	Ang
0.1	0.751	-26	27.7	24.169	152	-37.1	0.014	78	0.898	-13
0.5	0.322	-70	20.3	10.383	103	-26.4	0.048	68	0.584	-24
0.9	0.181	-84	15.9	6.208	85	-22.1	0.078	68	0.514	-25
1.0	0.160	-88	15.0	5.623	82	-21.3	0.086	67	0.508	-26
1.5	0.094	-102	11.8	3.885	68	-18.1	0.125	64	0.483	-30
1.8	0.068	-114	10.4	3.304	60	-16.5	0.149	61	0.473	-34
2.0	0.055	-123	9.6	3.012	56	-15.6	0.165	59	0.468	-37
3.0	0.032	146	6.7	2.161	34	-12.1	0.248	47	0.444	-52
4.0	0.075	86	4.9	1.759	14	-9.5	0.334	34	0.419	-70
5.0	0.148	67	3.7	1.538	-5	-7.5	0.424	20	0.375	-92
6.0	0.243	58	2.9	1.397	-24	-5.7	0.517	5	0.301	-120
7.0	0.354	47	2.2	1.292	-42	-4.3	0.613	-12	0.214	-162
8.0	0.464	32	1.5	1.190	-61	-3.2	0.695	-31	0.214	136
9.0	0.555	14	0.7	1.083	-79	-2.5	0.751	-51	0.311	89
10.0	0.636	-5	-0.3	0.967	-96	-2.3	0.765	-71	0.426	57

AT-32032 Typical Noise Parameters,

Common Emitter, $Z_O = 50 \Omega$, $V_{CE} = 5 \text{ V}$, $I_C = 10 \text{ mA}$

Freq. GHz	F_{min} dB	Γ_{opt}		R_n ohms	G_{assoc} dB
		Mag	Ang		
0.9	1.1	0.29	69	10.0	17.0
1.8	1.3	0.25	143	6.1	11.8
2.0	1.4	0.26	159	5.6	11.0
2.5	1.5	0.31	-165	5.5	9.6
3.0	1.7	0.37	-133	8.1	8.5
3.5	1.9	0.45	-106	14.6	7.7
4.0	2.1	0.52	-84	25.7	6.9

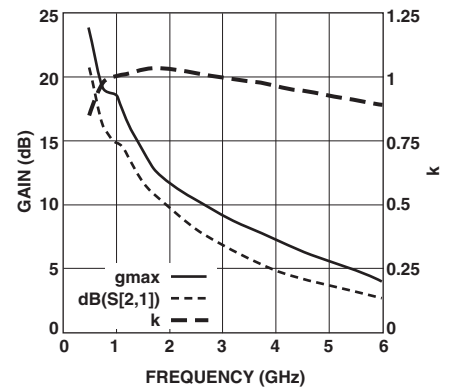

Figure 15. Gain vs. Frequency at 5 V, 10 mA.

Note: $\text{dB}(|S_{21}|) = 20 * \log(|S_{21}|)$

g_{max} = maximum available gain (MAG) if $k > 1$
 g_{max} = maximum stable gain (MSG) if $k < 1$
 k = stability factor

$$\text{MAG} = \left| \frac{S_{21}}{S_{12}} \right| (k \pm \sqrt{k^2 - 1})$$

$$\text{MSG} = |S_{21}| / |S_{12}|$$

$$k = \frac{1 - |S_{11}|^2 - |S_{22}|^2 + |D|^2}{2 * |S_{12}| |S_{21}|}; D = S_{11}S_{22} - S_{12}S_{21}$$

AT-32032 Application Information

The AT-32032 is described in a low noise amplifier for use in the 800 to 900 MHz frequency range. The amplifier is designed for use with .032 inch thickness FR-4 printed circuit board material.

900 MHz LNA Design

The amplifier is designed for a V_{ce} of 2.7 volts and I_c of 5 mA, and a nominal power supply voltage of 3 volts. The amplifier schematic is shown in Figure 16.

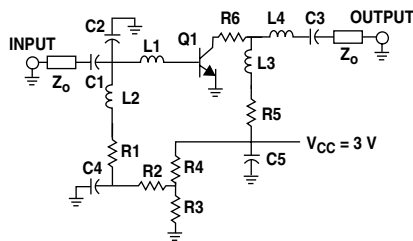

Figure 16. Schematic Diagram.

C1,C3	10 pF chip capacitor
C2	Open circuited stub .275 inch long
C4,C5	1000 pF chip capacitor
L1	8 nH chip inductor (Coilcraft 1008CS-080)
L2	Optional (see R1)
L3	56 nH chip inductor (Coilcraft 1008CS-560)
L4	15 nH chip inductor (Coilcraft 1008CS-150)
Q1 Silicon	Agilent AT-32032 Bipolar Transistor
R1	10 K Ω chip resistor (may want to substitute a 180 nH chip inductor and 50 W resistor for lower noise figure, better low freq stability, the readjust R2)
R2	26.1 K Ω chip resistor (adjust for rated I_c)
R3	3.32 K Ω chip resistor
R4	3.32 K Ω chip resistor
R5	51.1 Ω chip resistor
R6	13 Ω chip resistor (see text)
Zo	50 Ω microstripline

Figure 17. Component Parts List.

A component list is shown in Figure 17. The artwork including component placement is shown in Figure 18.

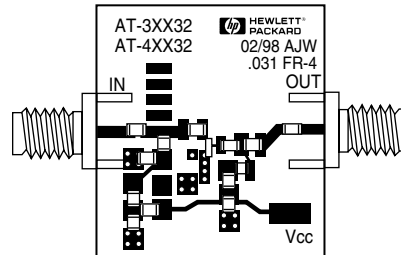

Figure 18. 1X Artwork showing Component Placement.

The input matching network uses a shunt C series L input impedance matching circuit for low noise. The shunt C is accomplished with an open circuited stub while a chip inductor is used for the series element. The output impedance matching network consists of a series chip inductor. Bias insertion is accomplished by the use of small inductors suitably bypassed. A resistor is placed in series with the output bias decoupling inductor to de-Q the network and improve in-band and low frequency stability. Surface mount Coilcraft inductors were chosen for their small size. Resistor R6 enhances broad band stability especially in the 9 to 10 GHz frequency range.

Biasing

The bias network is designed for a nominal power supply voltage of 3 volts. Resistors R1 and R2 are used to adjust collector current. Resistor R4 can be attached to the junction of R5 and C5 to improve bias point stability.

Performance

The measured gain of the completed amplifier is shown in Figure 19. The gain varies

from 15.5 to 16.5 dB over the 800 to 900 MHz frequency range. Noise figure versus frequency is shown in Figure 20. Best performance occurs at 950 MHz providing a 1.1 dB noise figure.

Measured input and output return loss is shown in Figure 21. The input return loss is 7 dB at 900 MHz and can be improved to 9 dB with a 0.1 dB increase in noise figure by increasing the amount of capacitance at C2. Additional capacitance at C2 increases the input return loss even further with increased noise figure. Output return loss is a nominal 12 to 15 dB.

Output intercept point, IP_3 , was measured at 900 MHz to be +14.3 dBm. This could be improved in two ways. The output resistors R5 and R6 could be varied in value. Increasing the value of R5 and decreasing the value of R6 will improve IP_3 although circuit stability may be sacrificed. The second method would be to optimize the output match for power as opposed to matching for lowest VSWR.

Using the AT-32032 at Other Frequencies

The demo board and design techniques presented here can be used to build low noise amplifiers for other frequencies in the VHF through 1.9 GHz frequency range.

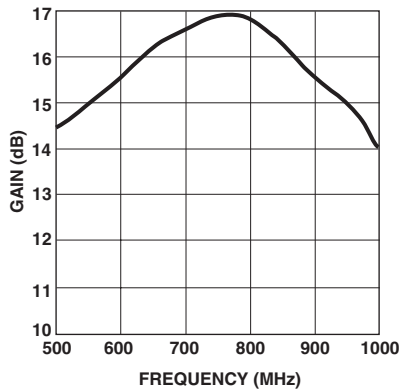

Figure 19. Gain vs Frequency.

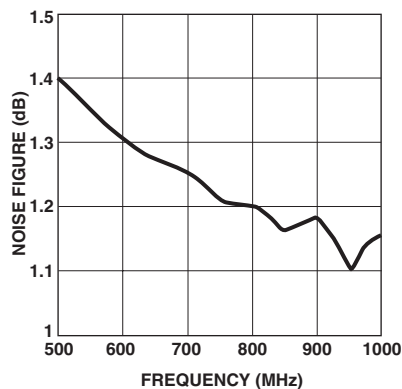

Figure 20. Noise Figure vs Frequency.

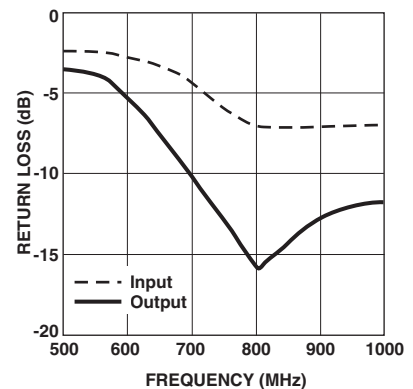

Figure 21. Input/Output Return Loss.

Ordering Information

Part Numbers	No. of Devices	Comments
AT-32032-BLK	100	Bulk
AT-32032-BLKG	100	Bulk
AT-32032-TR1	3000	7" Reel
AT-32032-TR1G	3000	7" Reel
AT-32032-TR2	10000	13" Reel
AT-32032-TR2G	10000	13" Reel

Note: Order part number with a "G" suffix if lead-free option is desired.

Package Dimensions SOT-323 Plastic Package

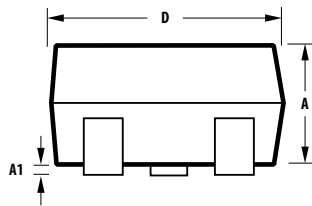
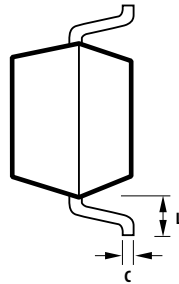
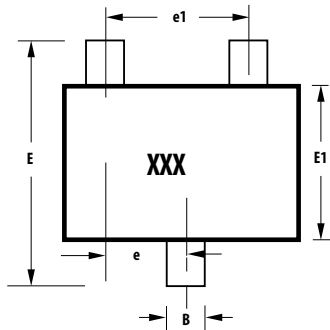

Notes:

XXX-package marking

Drawings are not to scale

SYMBOL	DIMENSIONS (mm)	
	MIN.	MAX.
A	0.80	1.00
A1	0.00	0.10
B	0.15	0.40
C	0.08	0.25
D	1.80	2.25
E1	1.10	1.40
e	0.65 typical	
e1	1.30 typical	
E	1.80	2.40
L	0.26	0.46

**Tape Dimensions and Product Orientation
For Outline SOT-323 (SC-70 3 Lead)**

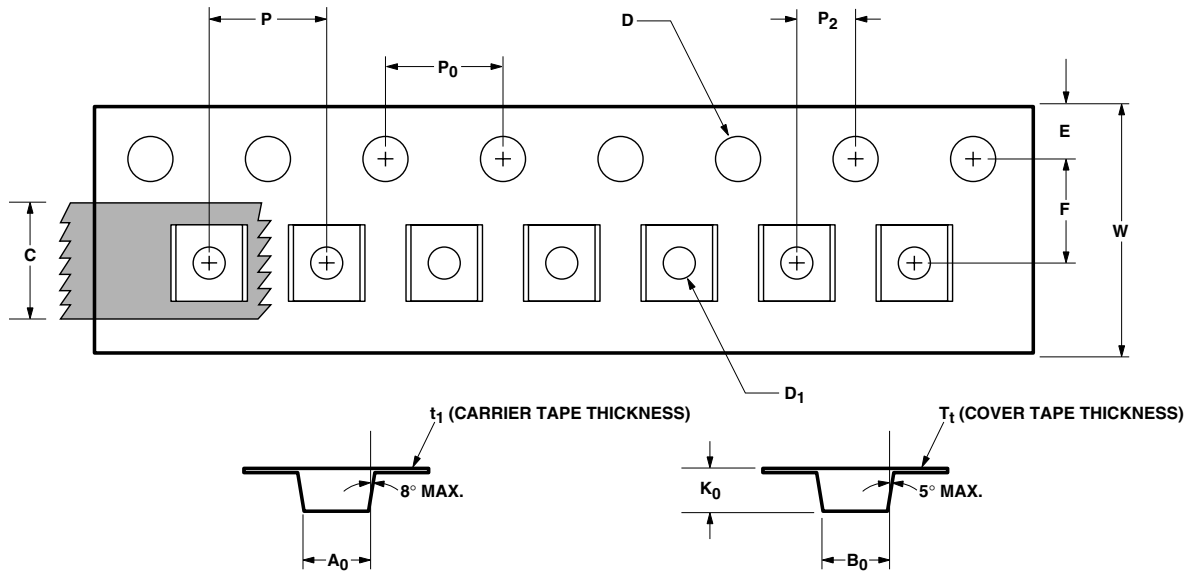

DESCRIPTION		SYMBOL	SIZE (mm)	SIZE (INCHES)
CAVITY	LENGTH	A ₀	2.24 ± 0.10	0.088 ± 0.004
	WIDTH	B ₀	2.34 ± 0.10	0.092 ± 0.004
	DEPTH	K ₀	1.22 ± 0.10	0.048 ± 0.004
	PITCH	P	4.00 ± 0.10	0.157 ± 0.004
	BOTTOM HOLE DIAMETER	D ₁	1.00 + 0.25	0.039 + 0.010
PERFORATION	DIAMETER	D	1.55 ± 0.05	0.061 ± 0.002
	PITCH	P ₀	4.00 ± 0.10	0.157 ± 0.004
	POSITION	E	1.75 ± 0.10	0.069 ± 0.004
CARRIER TAPE	WIDTH	W	8.00 ± 0.30	0.315 ± 0.012
	THICKNESS	t ₁	0.255 ± 0.013	0.010 ± 0.0005
COVER TAPE	WIDTH	C	5.4 ± 0.10	0.205 ± 0.004
	TAPE THICKNESS	T _t	0.062 ± 0.001	0.0025 ± 0.00004
DISTANCE	CAVITY TO PERFORATION (WIDTH DIRECTION)	F	3.50 ± 0.05	0.138 ± 0.002
	CAVITY TO PERFORATION (LENGTH DIRECTION)	P ₂	2.00 ± 0.05	0.079 ± 0.002

For product information and a complete list of distributors, please go to our web site: www.avagotech.com

Avago, Avago Technologies, and the A logo are trademarks of Avago Technologies in the United States and other countries. Data subject to change. Copyright © 2005-2009 Avago Technologies. All rights reserved. Obsoletes 5989-2644EN AV02-1963EN - June 9, 2009

