

# **INNOLUX DISPLAY CORPORATION**

## **LCD MODULE**

# **SPECIFICATION**

**Customer:**

**Model Name:** AT070TN07 V.C

**SPEC NO.:** A070-07-TT-C1

**Date:** 2009/03/26

**Version:** 01

**Preliminary Specification**

**Final Specification**

**For Customer's Acceptance**

<b>Approved by</b>	<b>Comment</b>

<b>Approved by</b>	<b>Reviewed by</b>	<b>Prepared by</b>
<b>Joe Lin</b>  2009/03/31	<b>James Yu Jack Huang Charlie Chou</b>  2009/03/31	<b>David Lee</b>  2009/03/26

The copyright belongs to InnoLux. Any unauthorized use is prohibited.

### Record of Revision

Version	Revise Date	Page	Content
Pre-spec. 01	2009/03/26		Initial release.

極機密文件

**Contents:**

1. General Specifications ..... 1

2. Pin Assignment ..... 2

    2.1. TFT LCD Panel Driving Section ..... 2

    2.2. Backlight Unit Section ..... 4

3. Operation Specifications ..... 5

    3.1. Absolute Maximum Rating ..... 5

        3.1.1. Typical Operation Conditions ..... 6

        3.1.2. Current Consumption ..... 7

        3.1.3. Backlight Driving Conditions ..... 7

    3.2. Power Sequence ..... 8

    3.3. Timing Characteristics ..... 9

        3.3.1. Timing Conditions ..... 9

        3.3.2. Timing Diagram ..... 11

4. Optical Specifications ..... 16

5. Reliability Test Items ..... 20

6. General Precautions ..... 20

    6.1. Safety ..... 21

    6.2. Handling ..... 21

    6.3. Static Electricity ..... 21

    6.4. Storage ..... 21

    6.5. Cleaning ..... 21

7. Mechanical Drawing ..... 22

8. Package Drawing ..... 23

    8.1. Packaging Material Table ..... 23

    8.2. Packaging Quantity ..... 23

    8.3. Packaging Drawing ..... 24

# 1. General Specifications

No.	Item	Specification	Remark
1	LCD size	7.0 inch	
2	Driver element	a-Si TFT active matrix	
3	Resolution	480 × 3(RGB) × 234	
4	Display mode	Normally White, Transmissive	
5	Dot pitch	0.107(W) × 0.370(H) mm	
6	Active area	154.08(W) × 86.58(H) mm	
7	Module size	164.9(W) × 100.0(H) × 5.7(D) mm	Note 1
8	Surface treatment	Anti-Glare	
9	Color arrangement	RGB-stripe	
10	Interface	Analog	
11	Backlight power consumption	1.116W (Typ.)	
12	Panel power consumption	0.111W (Typ.)	
13	Weight	(166g)	

Note 1: Refer to Mechanical Drawing.

## 2. Pin Assignment

### 2.1. TFT LCD Panel Driving Section

FPC Connector is used for the module electronics interface. The recommended model is FH19S-26S-0.5SH (51) manufactured by Hirose.

Pin No.	Symbol	I/O	Function	Remark
1	GND	P	Ground	
2	V <sub>CC</sub>	P	Supply voltage for scan driver	
3	V <sub>GL</sub>	P	Negative power for scan driver	
4	V <sub>GH</sub>	P	Positive power for scan driver	
5	STVD	I/O	Vertical start pulse	Note 1
6	STVU	I/O	Vertical start pulse	Note 1
7	CKV	I	Shift clock input for scan driver	
8	U/D	I	UP/DOWN scan control input	Note 1, 2
9	OEV	I	Output enable control for scan driver	
10	V <sub>COM</sub>	I	Common electrode driving signal	
11	V <sub>COM</sub>	I	Common electrode driving signal	
12	L/R	I	LEFT/RIGHT scan control input	Note 1, 2
13	MOD	I	Sequential sampling and simultaneous sampling setting	
14	OEH	I	Output enable control for data driver	
15	STHL	I/O	Start pulse for horizontal scan line	Note 1
16	STHR	I/O	Start pulse for horizontal scan line	Note 1
17	CPH3	I	Sampling and shifting clock pulse for data driver	
18	CPH2	I	Sampling and shifting clock pulse for data driver	
19	CPH1	I	Sampling and shifting clock pulse for data driver	

20	V <sub>CC</sub>	P	Supply voltage for scan driver	
21	GND	P	Ground	
22	V <sub>R</sub>	I	Alternated video signal (Red)	
23	V <sub>G</sub>	I	Alternated video signal (Green)	
24	V <sub>B</sub>	I	Alternated video signal (Blue)	
25	AV <sub>DD</sub>	P	Supply voltage for analog circuit	
26	AV <sub>SS</sub>	P	Ground for analog circuit	

I: input, O: output, P: Power

Note 1: Selection of scanning mode

Setting of scan control input		IN/OUT state for start pulse				Scanning direction
U/D	L/R	STVD	STVU	STHR	STHL	
GND	V <sub>CC</sub>	O	I	O	I	Up to down, left to right
V <sub>CC</sub>	GND	I	O	I	O	Down to up, right to left
GND	GND	O	I	I	O	Up to down, right to left
V <sub>CC</sub>	V <sub>CC</sub>	I	O	O	I	Down to up, left to right

Note 2: Definition of scanning direction.  
Refer to the figure as below:

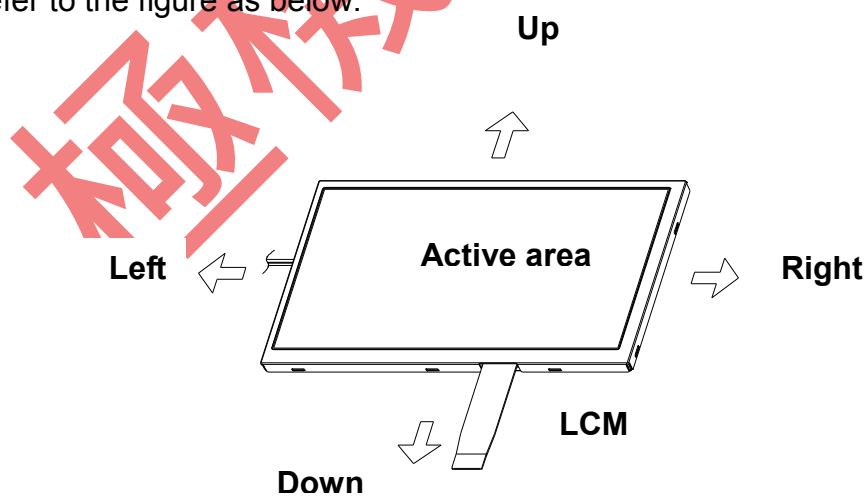

Note 3: MOD=H: Simultaneous sampling.  
MOD=L: Sequential sampling.  
Please set CPH2 and CPH3 to GND when MOD=H.

## 2.2. Backlight Unit Section

LED Light Bar Connector is used for the integral backlight system.  
The recommended model is BHSR-02VS-1 manufactured by JST.

Pin No.	Symbol	I/O	Function	Remark
1	V <sub>LED+</sub>	P	Power for LED backlight anode	Pink
2	V <sub>LED-</sub>	P	Power for LED backlight cathode	White

極機密文件

### 3. Operation Specifications

#### 3.1. Absolute Maximum Rating

( Note 3 )

Item	Symbol	Values		Unit	Remark
		Min.	Max.		
Power voltage	$V_{CC}$	-0.3	7	V	
	$AV_{DD}$	-0.3	7	V	
	$V_{GH}$	-0.3	18	V	
	$V_{GL}$	-15	0.3	V	
	$V_{GH}-V_{GL}$	-	33	V	
Input signal voltage	$V_i$	-0.2	$AV_{DD}+0.2$	V	Note 1
	$V_i$	-0.3	$V_{CC}+0.3$	V	Note 2
Operation temperature	$T_{OP}$	-30	85	°C	
Storage temperature	$T_{ST}$	-30	85	°C	
LED Reverse Voltage	$V_R$	-	1.2	V	Each LED
LED Forward Current	$I_F$	-	25	mA	Each LED

Note 1:  $V_R, V_G, V_B$ .

Note 2:  $STHL, STHR, OEH, L/R, CPH1\sim CPH3, STVR, STVL, OEV, CKV, U/D$ .

Note 3: The absolute maximum rating values of the module should not be exceeded. Once exceeded absolute maximum rating values, the characteristics of the module may not be recovered. Even in an extreme condition, may result in module permanently destroyed.

Note 4:  $V_R$  Conditions: Zener Diode 20mA.



**3.1.1. Typical Operation Conditions**

( Note 4)

Item	Symbol	Values			Unit	Remark
		Min.	Typ.	Max.		
Power voltage	V <sub>CC</sub>	3.1	3.3	3.5	V	Note 5
		4.8	5	5.2		
	AV <sub>DD</sub>	4.8	5	5.2	V	
	V <sub>GH</sub>	14.3	15	15.7	V	
	V <sub>GL</sub>	-10.5	-10	-9.5	V	
Video signal amplitude (V <sub>R</sub> , V <sub>G</sub> , V <sub>B</sub> )	V <sub>iA</sub>	0.2	-	AV <sub>DD</sub> -0.2	V	Note 1
	V <sub>iAC</sub>	-	3	-	V	AC component
	V <sub>iDC</sub>	-	AV <sub>DD</sub> /2	-	V	DC component
V <sub>COM</sub>	V <sub>CAC</sub>	3.5	5.6	6.5	V	Note 2
	V <sub>CDC</sub>	1.55	1.75	1.95	V	DC component
Input logic high voltage	V <sub>IH</sub>	0.8V <sub>CC</sub>	-	V <sub>CC</sub>	V	Note 3
Input logic low voltage	V <sub>IL</sub>	0	-	0.2V <sub>CC</sub>	V	

Note 1: Refer to Fig.3-3-(a).

Note 2: The brightness of LCD panel could be changed by adjusting the AC component of V<sub>COM</sub>.

Note 3: STHL, STHR, OEHL, L/R, CPH1~CPH3, STVD, STVU, OEV, CKV, U/D.

Note 4: GND, V<sub>CC</sub>, and V<sub>GL</sub> are applied to LCD first and then V<sub>GH</sub> is applied.

Note 5: V<sub>CC</sub> setting should match the signals output voltage (refer to Note 3) of customer's system board.

Item	Min.	Max.	Unit
Signal High Level (VCC=5V)	4	5	V
Signal Low Level (VCC=5V)	0	1	V
Signal High Level (VCC=3.3V)	2.5	3.3	V
Signal Low Level (VCC=3.3V)	0	0.6	V

**3.1.2. Current Consumption**

Item	Symbol	Values			Unit	Remark
		Min.	Typ.	Max.		
Current for Driver	I <sub>GH</sub>	-	0.2	0.5	mA	V <sub>GH</sub> =15.0V
	I <sub>GL</sub>	-	0.8	1.5	mA	V <sub>GL</sub> = -10.0V
	I <sub>CC</sub>	-	3.0	6.0	mA	V <sub>CC</sub> =5.0V
	I <sub>DD</sub>	-	17	30	mA	V <sub>DD</sub> =5.0V

**3.1.3. Backlight Driving Conditions**

Item	Symbol	Values			Unit	Remark
		Min.	Typ.	Max.		
Voltage for LED backlight	V <sub>L</sub>	8.4	9.3	10.5	V	Note 1
Current for LED backlight	I <sub>L</sub>	108	120	132	mA	Note 2
LED life time	-	20,000	-	-	Hr	Note 3

Note 1: The LED Supply Voltage is defined by the number of LED at Ta=25°C and I<sub>L</sub> =120mA. In the case of 3pcs LED, V<sub>L</sub>=3.1\*3=9.3V.

Note 2: The total current for LED backlight.

Note 3: The “LED life time” is defined as the module brightness decrease to 50% original brightness that the ambient temperature is 25°C and I<sub>L</sub> =120mA. The LED lifetime could be decreased if operating I<sub>L</sub> is larger than 120 mA.

### 3.2. Power Sequence

#### 1. Power on:

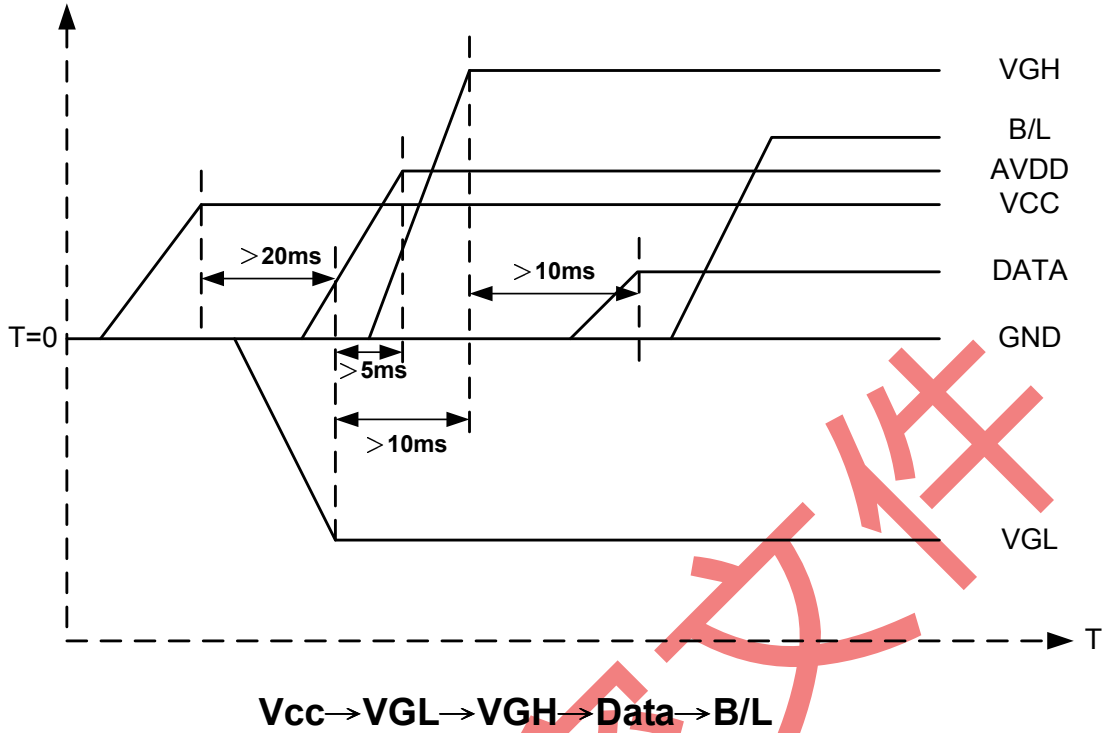

#### 2. Power off:

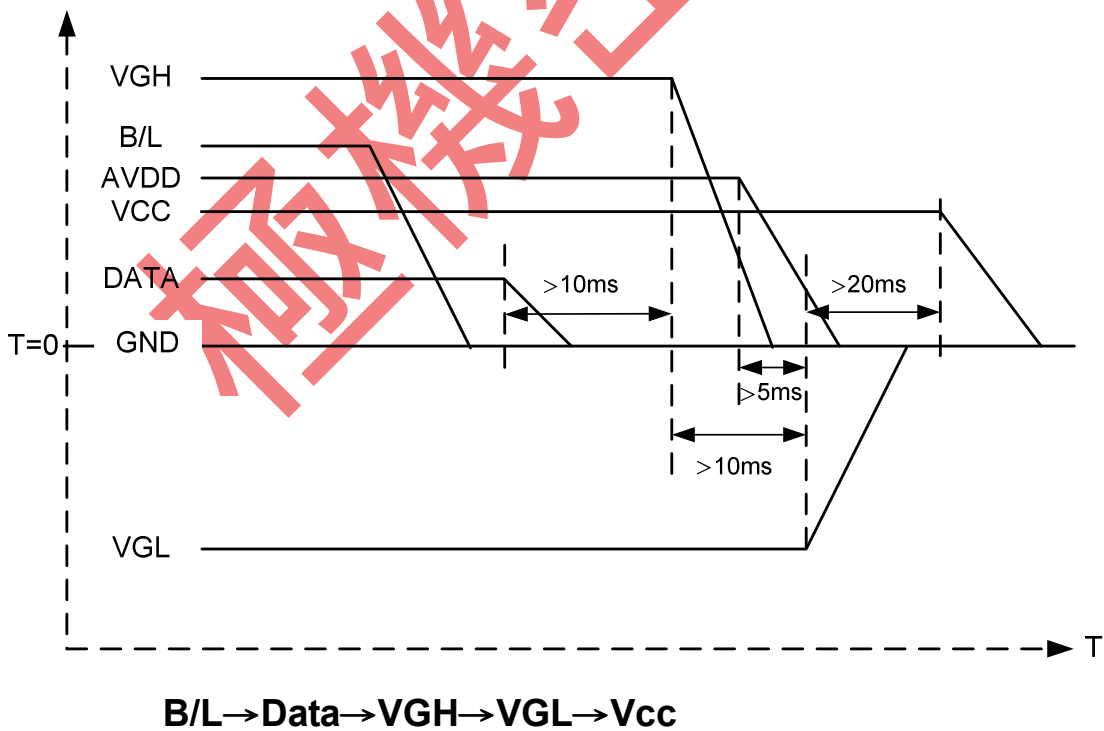

Note: Data include: STVD, STVU, CKV, OEH, STHL, STHR, CPH3, CPH2, CPH1, V<sub>R</sub>, V<sub>G</sub>, V<sub>B</sub>.

### 3.3. Timing Characteristics

#### 3.3.1. Timing Conditions

Item	Symbol	Values			Unit	Remark
		Min.	Typ.	Max.		
Rising time	$t_r$	-	-	10	ns	Note 1
Falling time	$t_f$	-	-	10	ns	Note 1
High and low level pulse width	$t_{CPH}$	99	103	107	ns	CPH1~CPH3
CPH pulse duty	$t_{CWH}$	40	50	60	%	CPH1~CPH3
CPH pulse delay	$t_{C12}$	30	$t_{CPH}/3$	$t_{CPH}/2$	ns	CPH1~CPH3
	$t_{C23}$					
	$t_{C31}$					
STH setup time	$t_{SUH}$	20	-	-	ns	STHR, STHL
STH hold time	$t_{HDH}$	20	-	-	ns	STHR, STHL
STH pulse width	$t_{STH}$	-	1	-	$t_{CPH}$	STHR, STHL
STH period	$t_H$	61.5	63.5	65.5	$\mu s$	STHR, STHL
OEH pulse width	$t_{OEH}$	-	1.22	-	$\mu s$	
Sample and hold disable time	$t_{DIS1}$	-	8.28	-	$\mu s$	
OEV pulse width	$t_{OEV}$	-	5.40	-	$\mu s$	
CKV pulse width	$t_{CKV}$	-	4.18	-	$\mu s$	
Clean enable time	$t_{DIS2}$	-	3.74	-	$\mu s$	
Horizontal display start	$t_{SH}$	-	0	-	$t_{CPH}/3$	
Horizontal display timing range	$t_{DH}$	-	1440	-	$t_{CPH}/3$	
STV setup time	$t_{SUV}$	400	-	-	ns	STVU, STVD
STV hold time	$t_{HDV}$	400	-	-	ns	STVU, STVD

STV pulse width	$t_{STV}$	-	-	1	$t_H$	STVU, STVD
Horizontal lines per field	$t_V$	256	262	268	$t_H$	Note 2
Vertical display start	$t_{SV}$	-	3	-	$t_H$	
Vertical display timing range	$t_{DV}$	-	234	-	$t_H$	
$V_{COM}$ rising time	$t_{rCOM}$	-	-	5	$\mu s$	
$V_{COM}$ falling time	$t_{fCOM}$	-	-	5	$\mu s$	
$V_{COM}$ delay time	$t_{DCOM}$	-	-	3	$\mu s$	
RGB delay time	$t_{DRGB}$	-	-	1	$\mu s$	

Note 1: For all of the logic signals

Note 2: Please don't use odd horizontal lines to drive LCD panel for both odd and even field simultaneously.

極機密文件

3.3.2. Timing Diagram

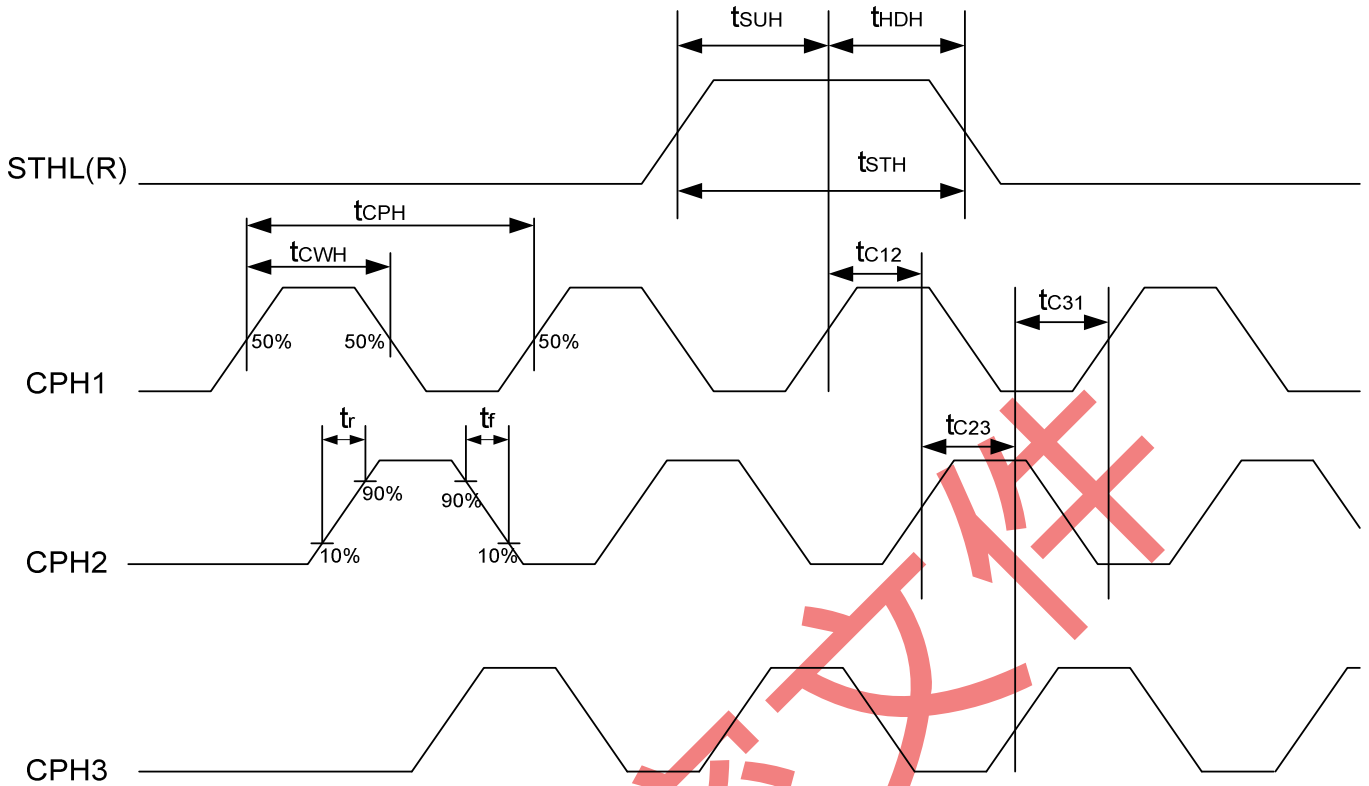

Fig.3-1 Sampling clock timing

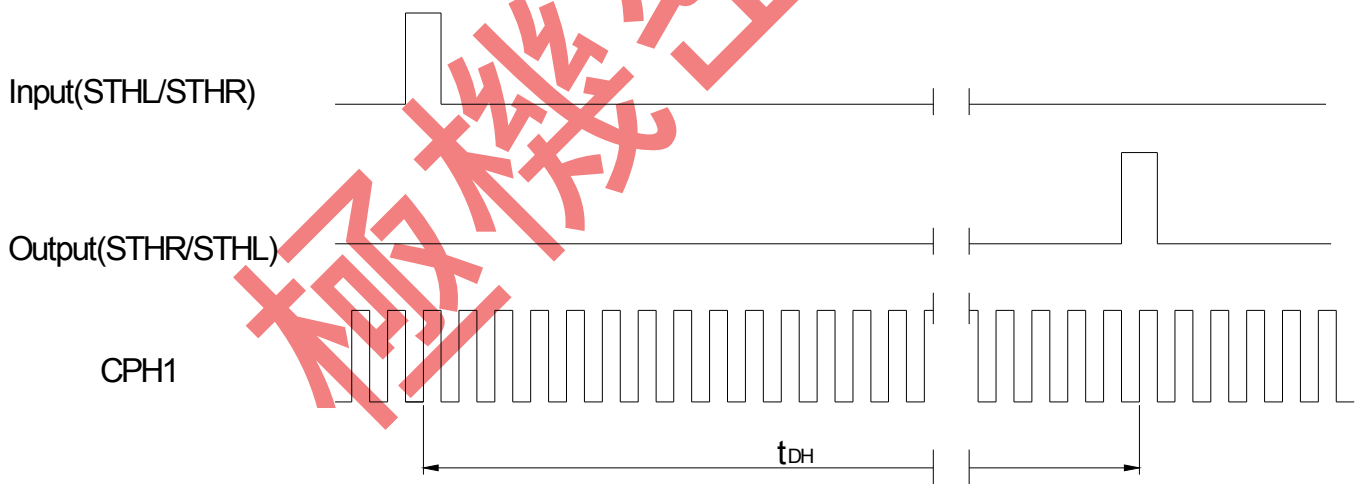

Fig.3-2 Horizontal display timing range

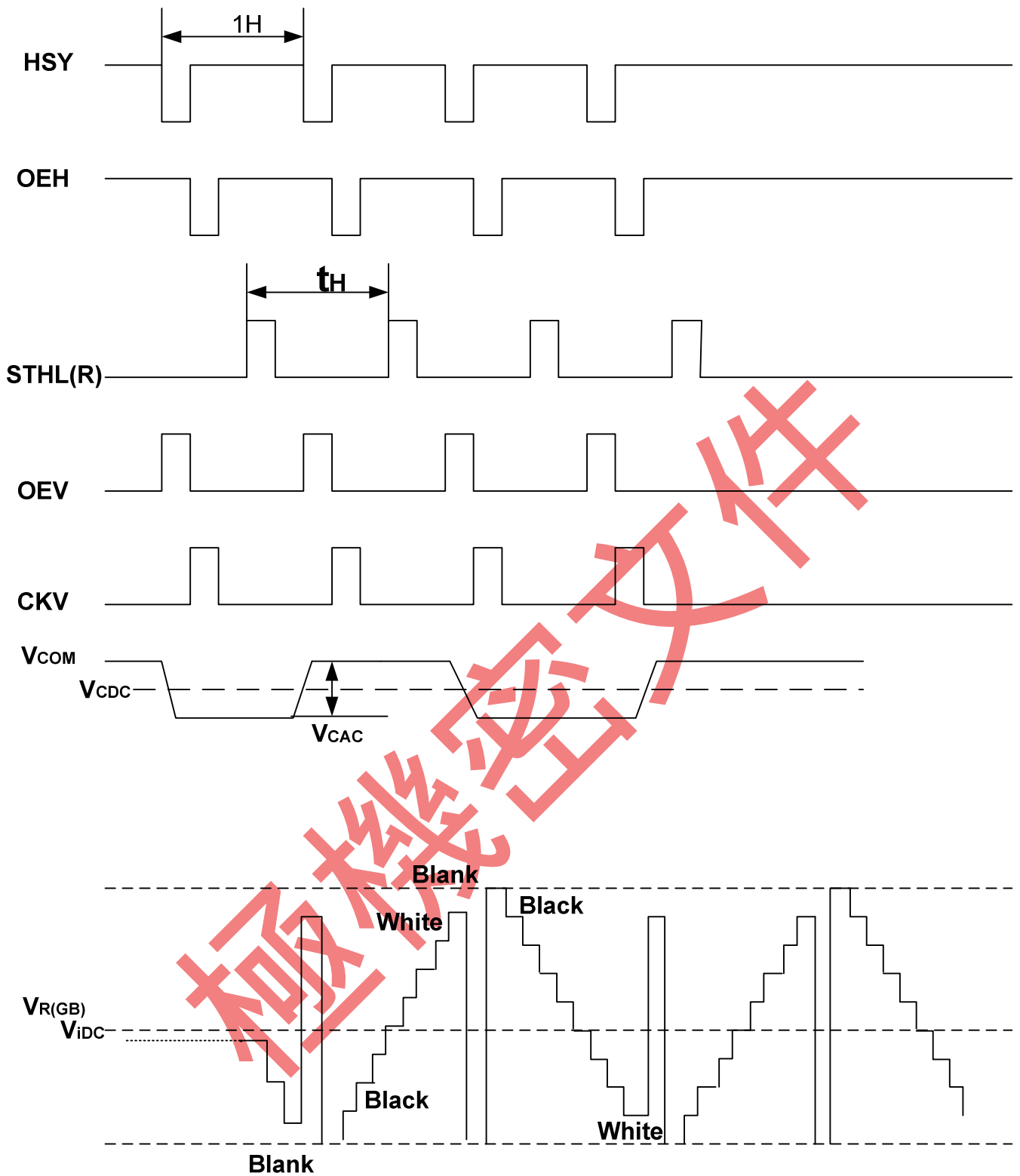

Fig.3-3-(a) Horizontal timing

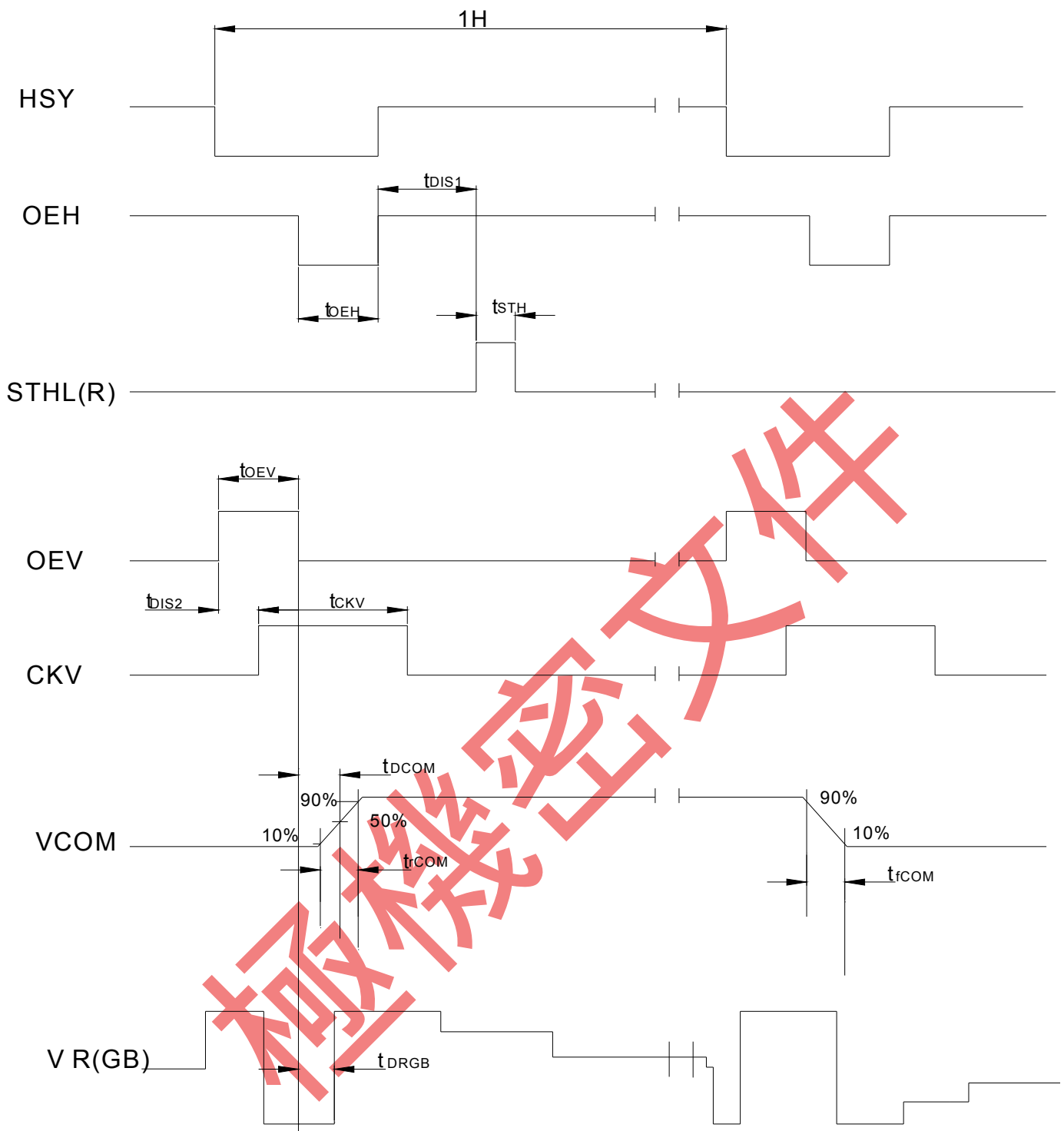

Fig.3-3-(b) Detail horizontal timing



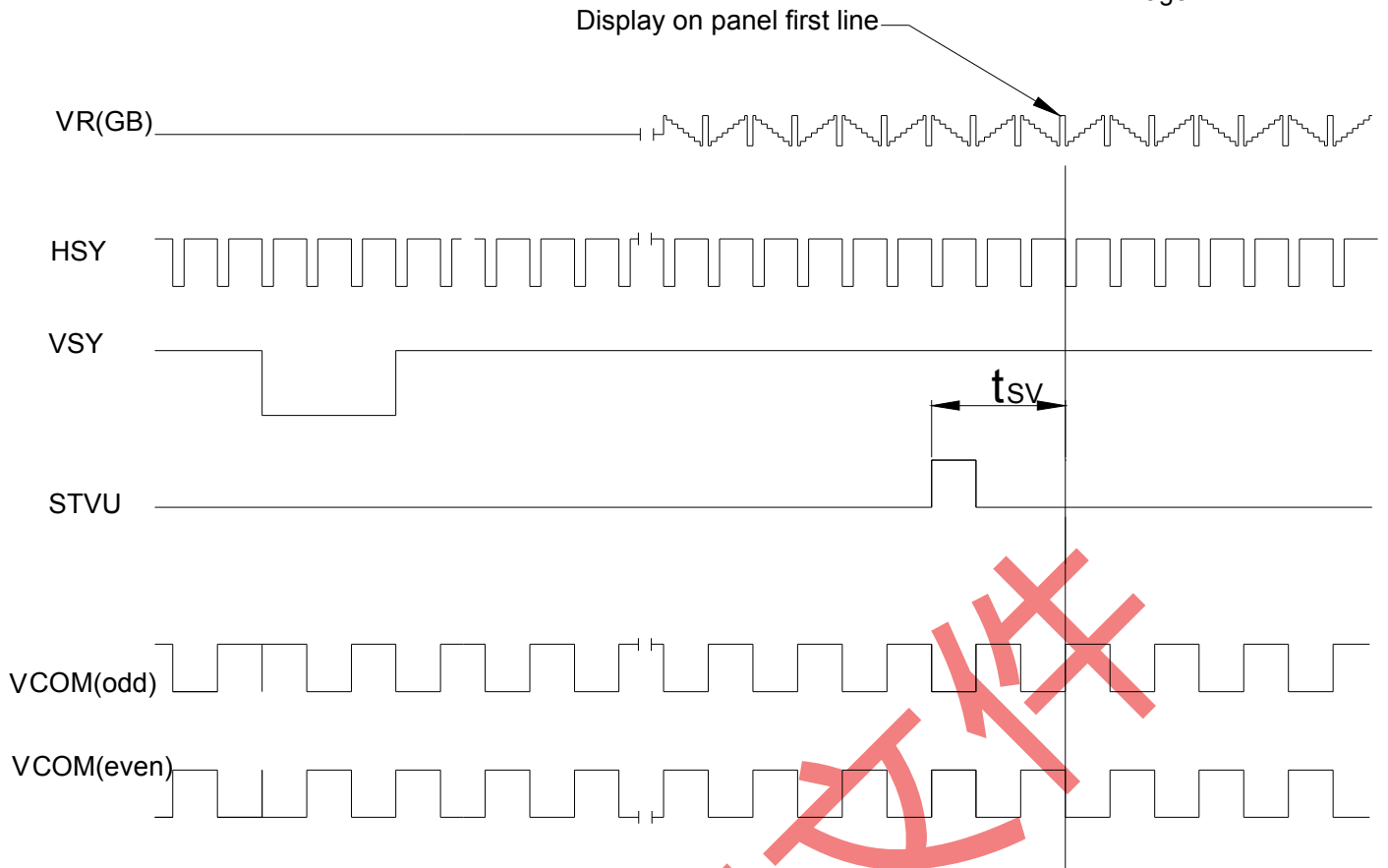

Fig.3-4(a) Vertical timing (from up to down)

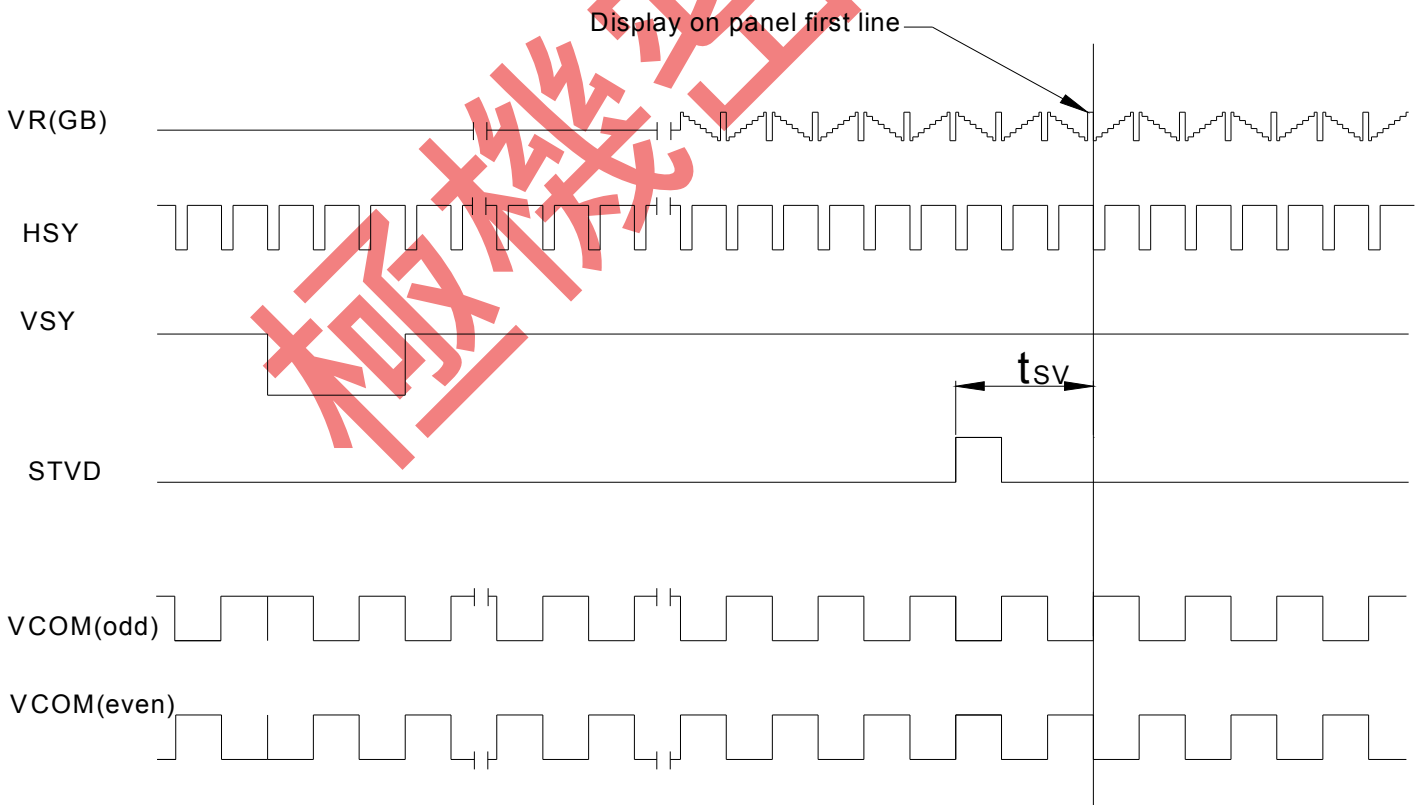

Fig.3-4(b) Vertical timing (from down to up)

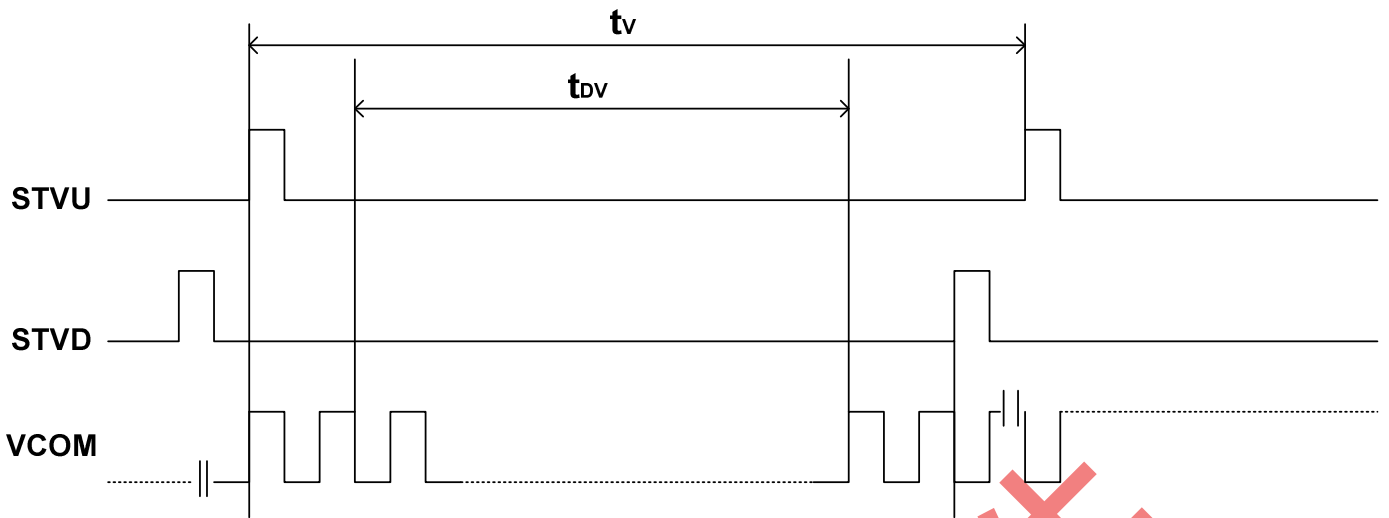

Fig.3-5 Vertical start pulse timing

極機密文件

## 4. Optical Specifications

Item	Symbol	Condition	Values			Unit	Remark
			Min.	Typ.	Max.		
Viewing angle (CR≥10)	$\theta_L$	$\Phi=180^\circ$ (9 o'clock)	50	60	-	degree	Note 1
	$\theta_R$	$\Phi=0^\circ$ (3 o'clock)	50	60	-		
	$\theta_T$	$\Phi=90^\circ$ (12 o'clock)	30	40	-		
	$\theta_B$	$\Phi=270^\circ$ (6 o'clock)	50	60	-		
Response time	$T_{ON}$	Normal $\theta=\Phi=0^\circ$	-	15	30	msec	Note 3
	$T_{OFF}$		-	20	40	msec	Note 3
Contrast ratio	CR		250	300	-	-	Note 4
Color chromaticity	$W_X$		0.26	0.31	0.36	-	Note 2 Note 5
	$W_Y$		0.28	0.33	0.38	-	Note 6
Luminance	L		450	500	-	cd/m <sup>2</sup>	Note 6
Luminance uniformity	$Y_U$		70	75	-	%	Note 7

**Test Conditions:**

1.  $V_{CC}=5V$ ,  $A_{V_{DD}}=5V$ ,  $I_L=120\text{ mA}$  (Backlight current), the ambient temperature is  $25^\circ\text{C}$ .
2. The test systems refer to Note 2.

Note 1: Definition of viewing angle range

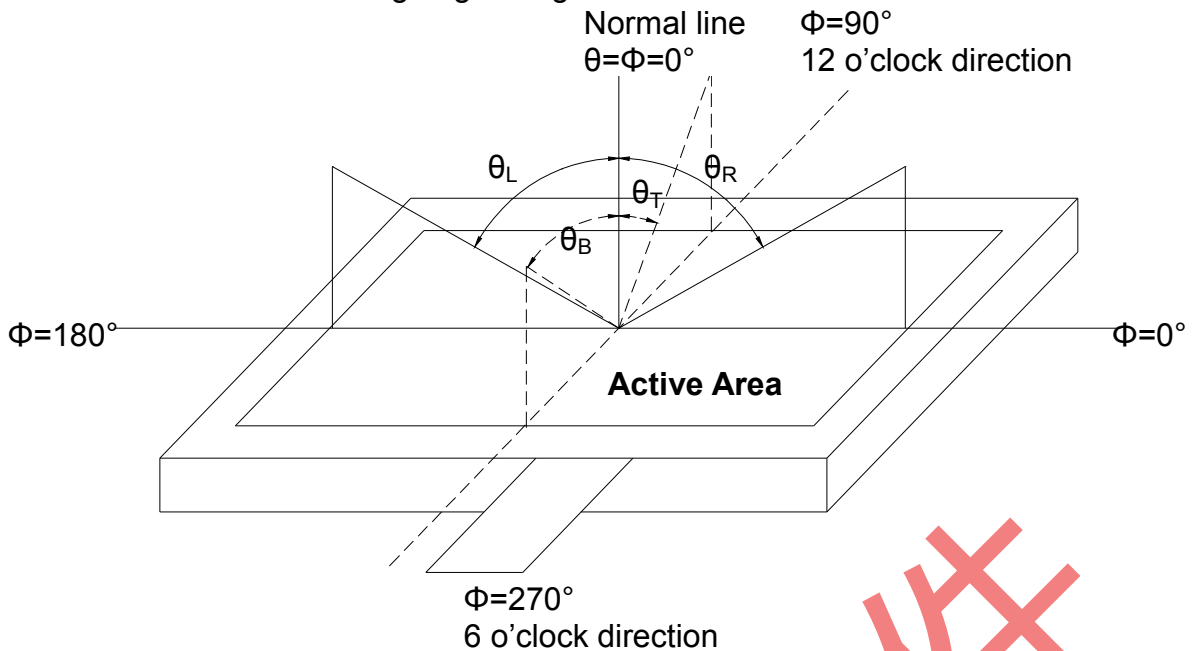

Fig. 4-1 Definition of viewing angle

Note 2: Definition of optical measurement system.

The optical characteristics should be measured in dark room. The optical properties are measured at the center point of the LCD screen. (Response time is measured by Photo detector TOPCON BM-7, other items are measured by BM-5A/Field of view: 1° /Height: 500mm.)

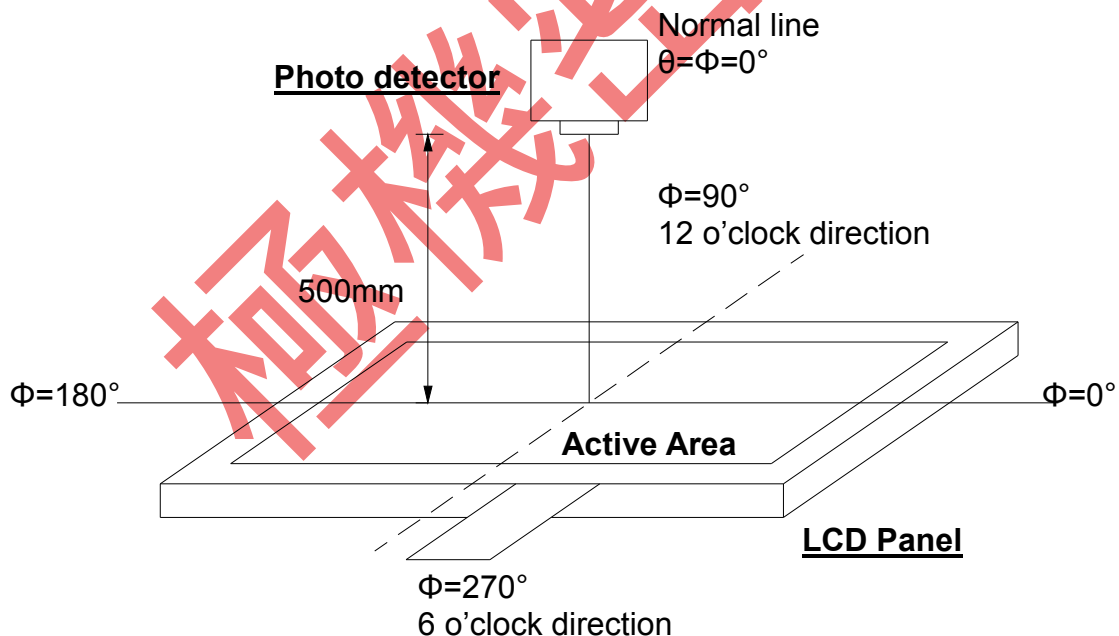

Fig. 4-2 Optical measurement system setup

Note 3: Definition of Response time

The response time is defined as the LCD optical switching time interval between "White" state and "Black" state. Rise time ( $T_{ON}$ ) is the time between photo detector output intensity changed from 90% to 10%. And fall time ( $T_{OFF}$ ) is the time between photo detector output intensity changed from 10% to 90%.

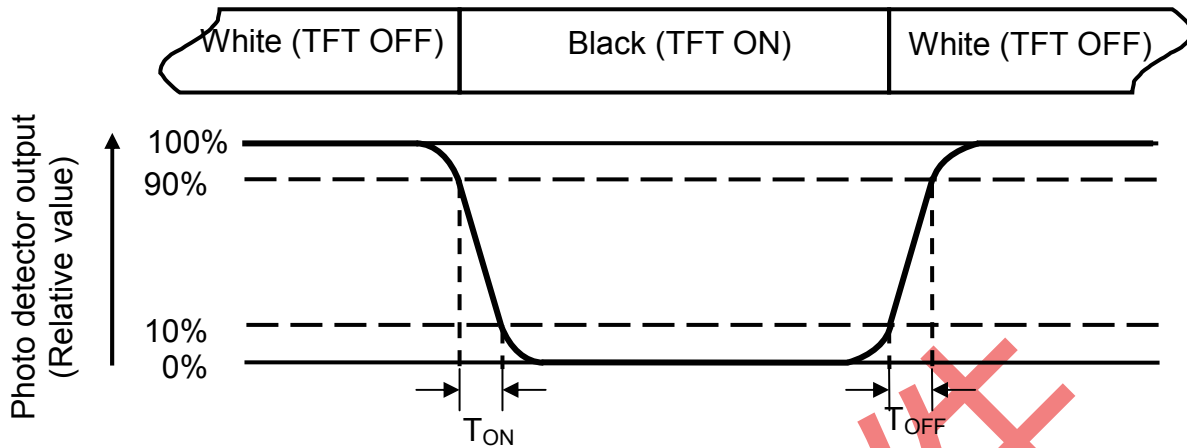

Fig. 4-3 Definition of response time

Note 4: Definition of contrast ratio

$$\text{Contrast ratio (CR)} = \frac{\text{Luminance measured when LCD is on the "White" state}}{\text{Luminance measured when LCD is on the "Black" state}}$$

White  $V_i = V_{i50\%} \pm 1.5 \text{ V}$

Black  $V_i = V_{i50\%} \mu 2.0 \text{ V}$

“±” means that the analog input signal swings in phase with  $V_{COM}$  signal.

“μ” means that the analog input signal swings out of phase with  $V_{COM}$  signal.

$V_{i50\%}$ : The analog input voltage when transmission is 50%

The 100% transmission is defined as the transmission of LCD panel when all the input terminals of module are electrically opened.

Note 5: Definition of color chromaticity (CIE1931)

Color coordinates measured at center point of LCD.

Note 6: All input terminals LCD panel must be ground while measuring the center area of the panel. The LED driving condition is  $I_L=120\text{mA}$  of total current for LED backlight.

Note 7: Definition of Luminance Uniformity

Active area is divided into 9 measuring areas (Refer to Fig. 4-4 ).Every measuring point is placed at the center of each measuring area.

$$\text{Luminance Uniformity (Yu)} = \frac{B_{min}}{B_{max}}$$

L-----Active area length      W----- Active area width

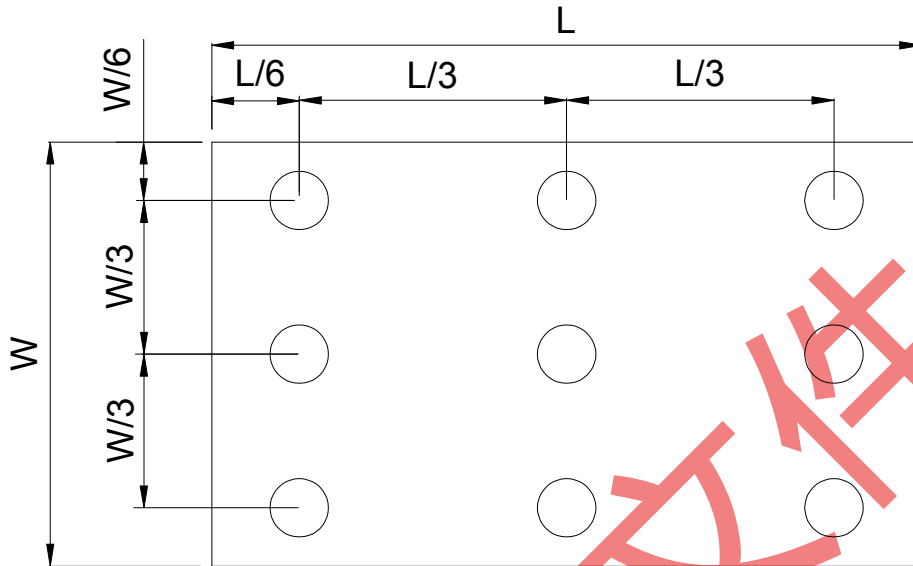

Fig. 4-4 Definition of measuring points

- B<sub>max</sub>**: The measured maximum luminance of all measurement position.
- B<sub>min</sub>**: The measured minimum luminance of all measurement position.

極機密文件

### 5. Reliability Test Items

(Note3)

Item	Test Conditions	Remark
High Temperature Storage	Ta = 85°C                          240 hrs	Note 1,Note 4
Low Temperature Storage	Ta = -30°C                          240hrs	Note 1,Note 4
High Temperature Operation	Ts = 85°C                          240hrs	Note 2,Note 4
Low Temperature Operation	Ta = -30°C                          240hrs	Note 1,Note 4
Operate at High Temperature and Humidity	+60°C, 90%RH max.                  240 hrs	Note 4
Thermal Shock	-30°C/30 min ~ +85°C/30 min for a total 100 cycles, Start with cold temperature and end with high temperature	Note 4
Vibration Test	Frequency range:10~55Hz Stroke:1.5mm Sweep:10Hz~55Hz~10Hz 2 hours for each direction of X. Y. Z. (6 hours for total)	
Mechanical Shock	100G 6ms,±X, ±Y, ±Z 3 times for each direction	
Package Vibration Test	Random Vibration : 0.015G*G/Hz from 5-200HZ, -6dB/Octave from 200-500HZ 2 hours for each direction of X. Y. Z. (6 hours for total)	
Package Drop Test	Height:60 cm 1 corner, 3 edges, 6 surfaces	
Electro Static Discharge	± 2KV, Human Body Mode, 100pF/1500Ω	

Note 1: Ta is the ambient temperature of samples.

Note 2: Ts is the temperature of panel's surface.

Note 3: In the standard condition, there shall be no practical problem that may affect the display function. After the reliability test, the product only guarantees operation, but doesn't guarantee all the cosmetic specification.

Note 4: Before cosmetic and function test, the product must have enough recovery time, at least 2 hours at room temperature.

## 6. General Precautions

### 6.1. Safety

Liquid crystal is poisonous. Do not put it in your mouth. If liquid crystal touches your skin or clothes, wash it off immediately by using soap and water.

### 6.2. Handling

1. The LCD panel is plate glass. Do not subject the panel to mechanical shock or to excessive force on its surface.
2. The polarizer attached to the display is easily damaged. Please handle it carefully to avoid scratch or other damages.
3. To avoid contamination on the display surface, do not touch the module surface with bare hands.
4. Keep a space so that the LCD panels do not touch other components.
5. Put cover board such as acrylic board on the surface of LCD panel to protect panel from damages.
6. Transparent electrodes may be disconnected if you use the LCD panel under environmental conditions where the condensation of dew occurs.
7. Do not leave module in direct sunlight to avoid malfunction of the ICs.

### 6.3. Static Electricity

1. Be sure to ground module before turning on power or operating module.
2. Do not apply voltage which exceeds the absolute maximum rating value.

### 6.4. Storage

1. Store the module in a dark room where must keep at  $+25\pm 10^{\circ}\text{C}$  and 65%RH or less.
2. Do not store the module in surroundings containing organic solvent or corrosive gas.
3. Store the module in an anti-electrostatic container or bag.

### 6.5. Cleaning

1. Do not wipe the polarizer with dry cloth. It might cause scratch.
2. Only use a soft sloth with IPA to wipe the polarizer, other chemicals might permanent damage to the polarizer.



# 7. Mechanical Drawing

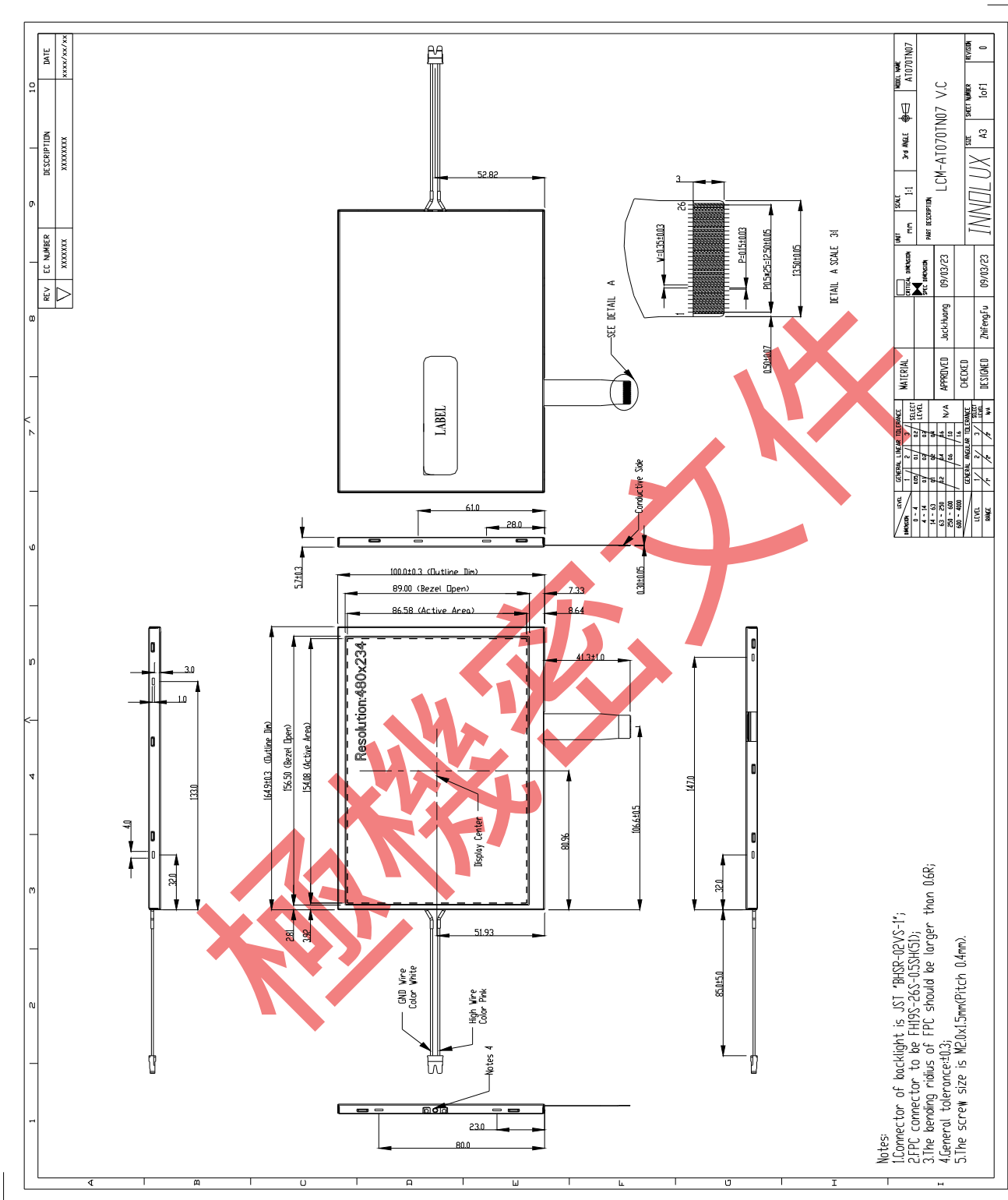

REV	EC NUMBER	DESCRIPTION	DATE
▽	XXXXXX	XXXXXXXX	XXXX/XX/XX

DATE	DESIGNER	CHECKER	APPROVED	DATE	SCALE	FIG. NO.	FIG. NAME	FIG. NO.	FIG. NAME
09/03/23	Zhuifengfu			09/03/23	A3	11	24 PAGE	11	A10701N07
MATERIAL		APPROVED		LCK-A10701N07 V.C		INNOLUX		A3	
CHECKED		DESIGNED		10F1		0			

## 8. Package Drawing

### 8.1. Packaging Material Table

No.	Item	Model (Material)	Dimensions(mm)	Unit Weight (kg)	Quantity	Remark
1	LCM Module	AT070TN07 V.C	164.9 × 100.0 × 5.7	(0.166)	50 pcs	
2	Partition	BC Corrugated paper	512 × 349 × 226	1.360	1 set	
3	Corrugated Bar	B Corrugated paper	512 × 11 × 3	0.032	4 set	
4	Dust-Proof Bag	PE	700 × 530	0.041	1 pcs	
5	A/S Bag	PE	180 × 133 × 0.2	0.002	50 pcs	
6	Carton	Corrugated paper	530 × 355 × 255	0.830	1 pcs	
7	Total weight	(10.759)± 5%Kg				

### 8.2. Packaging Quantity

Total LCM quantity in Carton: no. of Partition	2 Rows x	quantity per Row	25	= 50
--	----------	------------------	----	------

### 8.3. Packaging Drawing

