

INNOLUX DISPLAY CORPORATION

LCD MODULE

SPECIFICATION

Customer: _____
Model Name: AT070TN84 V.1
SPEC NO.: A070-84-TT-11
Date: 2008/07/21
Version: 01

- Preliminary Specification
 Final Specification

For Customer's Acceptance

Approved by	Comment

Approved by	Reviewed by	Prepared by
Joe Lin	Hans Chen	Kevin Chen
2008/07/31	2008/07/31	2008/07/31

版權屬於群創所有，禁止任何未經授權的使用
The copyright belongs to InnoLux. Any unauthorized use is prohibited.

The copyright belongs to INNOLUX. Any unauthorized use is prohibited.

<http://www.BDTIC.com/InnoLux>

Record of Revision

Version	Revise Date	Page	Content
Pre-spec. 01	2008/07/21		Initial release.

Contents

1. General Specifications	1
2. Pin Assignment	2
2.1. TFT LCD Panel Driving Section	2
2.2. Backlight Unit Section	5
3. Operation Specifications	6
3.1. Absolute Maximum Ratings	6
3.2. Typical Operation Conditions	7
3.2.1. Current Consumption	8
3.2.2. Backlight Driving Conditions	8
3.3. Power Sequence	9
3.4. Timing Characteristics	10
3.4.1. Timing Conditions	10
3.4.2. Timing Diagram	12
4. Optical Specifications	19
5. Reliability Test Items	23
6. General Precautions	24
6.1. Safety	24
6.2. Handling	24
6.3. Static Electricity	24
6.4. Storage	24
6.5. Cleaning	24
7. Mechanical Drawing	25
8. Package Drawing	26
8.1. Packaging Material Table	26
8.2. Packaging Quantity	26
8.3. Packaging Drawing	27

1. General Specifications

No.	Item	Specification	Remark
1	LCD size	7.0 inch(Diagonal)	
2	Driver element	a-Si TFT active matrix	
3	Resolution	800 × 3(RGB) × 480	
4	Display mode	Normally white, Transmissive	
5	Dot pitch	0.0635(W) × 0.1905(H) mm	
6	Active area	152.4 (W) × 91.44 (H) mm	
7	Module size	165(W) × 104(H) × 5.5(D) mm	Note1
8	Surface treatment	Anti-Glare	
9	Color arrangement	RGB-stripe	
10	Interface	Digital	
11	Backlight power consumption	(1.782W) (Typ.)	
12	Panel power consumption	0.437W (Typ.)	
13	Weight	TBD	

Note1: Refer to Mechanical Drawing.

2. Pin Assignment

2.1. TFT LCD Panel Driving Section

FPC Connector is used for the module electronics interface. The recommended model is P-TWO "AF 730L-A2G1T" manufactured by P-TWO.

Pin No.	Symbol	I/O	Function	Remark
1	POL	I	Polarity selection	
2	STVD	I/O	Vertical start pulse input when U/D= H	Note 1
3	OEV	I	Output enable	
4	CKV	I	Vertical clock	
5	STVU	I/O	Vertical start pulse input when U/D= L	Note 1
6	GND	P	Power Ground	
7	EDGSL	I	Select rising edge or falling edge	
8	DV _{DD}	P	Power Voltage for Digital Circuit	
9	V9	I	Gamma voltage level 9	
10	V _{GL}	P	Gate OFF voltage	
11	V2	I	Gamma voltage level 2	
12	V _{GH}	P	Gate ON voltage	
13	V6	I	Gamma voltage level 6	
14	U/D	I	Up/down selection	Note 1,2
15	V _{COM}	I	Common voltage	
16	GND	P	Power Ground	
17	AV _{DD}	P	Power Voltage for Analog Circuit	
18	V14	I	Gamma voltage level 14	
19	V11	I	Gamma voltage level 11	

版權屬於群創所有，禁止任何未經授權的使用

The copyright belongs to InnoLux. Any unauthorized use is prohibited.

<http://www.BDTIC.com/InnoLux>

20	V8	I	Gamma voltage level 8	
21	V5	I	Gamma voltage level 5	
22	V3	I	Gamma voltage level 3	
23	GND	P	Power Ground	
24	R5	I	Red data(MSB)	
25	R4	I	Red data	
26	R3	I	Red data	
27	R2	I	Red data	
28	R1	I	Red data	
29	R0	I	Red data(LSB)	
30	GND	P	Power Ground	
31	GND	P	Power Ground	
32	G5	I	Green data(MSB)	
33	G4	I	Green data	
34	G3	I	Green data	
35	G2	I	Green data	
36	G1	I	Green data	
37	G0	I	Green data(LSB)	
38	STHL	I/O	Horizontal start pulse input when R/L = L	Note 1
39	REV	I	Control signal are inverted or not	Note3
40	GND	I	Power Ground	
41	DCLK	I	Sample clock	
42	DV _{DD}	P	Power Voltage for Digital Circuit	
43	STHR	I/O	Horizontal start pulse input when R/L =H	Note 1
44	LD	I	Latches the polarity of outputs and Switches the new data to outputs	

45	B5	I	Blue data (MSB)	
46	B4	I	Blue data	
47	B3	I	Blue data	
48	B2	I	Blue data	
49	B1	I	Blue data	
50	B0	I	Blue data (LSB)	
51	R/L	I	Right/ left selection	Note 1,2
52	V1	I	Gamma voltage level 1	
53	V4	I	Gamma voltage level 4	
54	V7	I	Gamma voltage level 7	
55	V10	I	Gamma voltage level 10	
56	V12	I	Gamma voltage level 12	
57	V13	I	Gamma voltage level 13	
58	AV _{DD}	P	Power Voltage for Analog Circuit	
59	GND	P	Power Ground	
60	V _{COM}	I	Common voltage	

I: input, O: output, P: Power

Note 1: Selection of scanning mode

Setting of scan control input		IN/OUT state for start pulse				Scanning direction
U/D	R/L	STVD	STVU	STHR	STHL	
GND	DV _{DD}	O	I	I	O	Up to down, left to right
DV _{DD}	GND	I	O	O	I	Down to up, right to left
GND	GND	O	I	O	I	Up to down, right to left
DV _{DD}	DV _{DD}	I	O	I	O	Down to up, left to right

版權屬於群創所有，禁止任何未經授權的使用

The copyright belongs to InnoLux. Any unauthorized use is prohibited.

<http://www.BDTIC.com/InnoLux>

Note 2: Definition of scanning direction.
Refer to the figure as below:

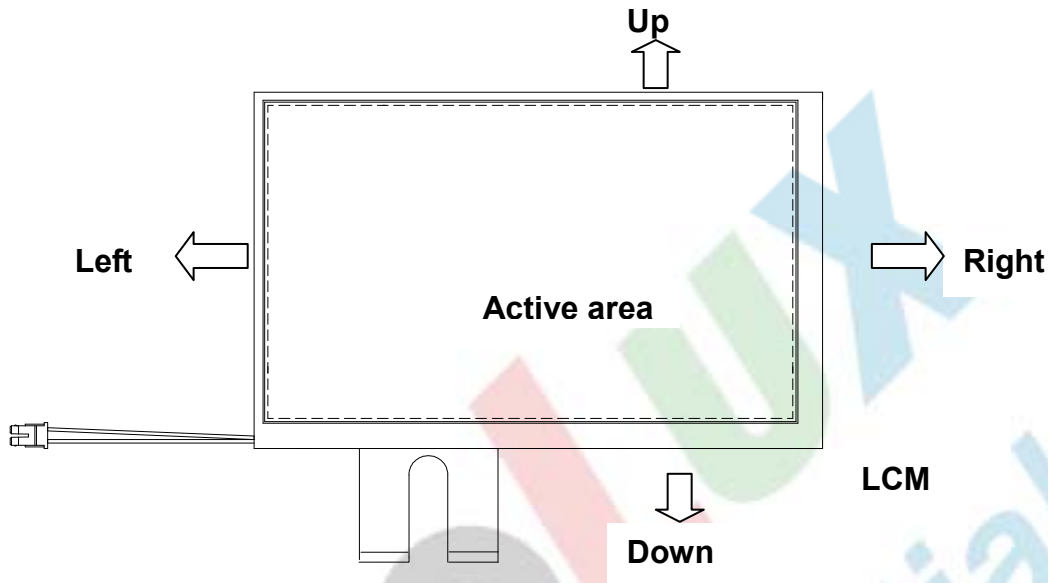

Note 3: When REV="L", it's under normal operation.
When REV="H", these data will be inverted.

2.2. Backlight Unit Section

LED Light Bar Connector is used for the integral backlight system.
The recommended model is BHSR-02VS-1 manufactured by JST.

Pin No.	Symbol	I/O	Function	Remark
1	V _{LED+}	P	Power for LED backlight anode	Pink
2	V _{LED-}	P	Power for LED backlight cathode	White

3. Operation Specifications

3.1. Absolute Maximum Ratings

(Note 2)

Item	Symbol	Values		Unit	Remark
		Min.	Max.		
Power voltage	DV _{DD}	-0.5	5	V	
	AV _{DD}	-0.5	13.5	V	
	V _{GH}	-0.3	20.0	V	
	V _{GL}	-13.0	0.3	V	
	V _{GH} -V _{GL}	-	33.0	V	
Input signal voltage	V1~V7	0.4 AV _{DD}	AV _{DD} +0.3	V	Note 1
	V8~V14	-0.3	0.6AV _{DD}	V	
Operation Temperature	T _{OP}	-30	85	°C	
Storage Temperature	T _{ST}	-30	85	°C	
LED Reverse Voltage	V _r	-	1.2	V	Each LED Note 3
LED Forward Current	I _F	-	25	mA	Each LED

Note 1: AV_{DD}-0.1 ≥ V1 ≥ V2 ≥ V3 ≥ V4 ≥ V5 ≥ V6 ≥ V7,
V8 ≥ V9 ≥ V10 ≥ V11 ≥ V12 ≥ V13 ≥ V14 ≥ AV_{SS}+0.1.

Note 2: The absolute maximum rating values of this product are not allowed to be exceeded at any times. A module should be used with any of the absolute maximum ratings exceeded, the characteristics of the module may not be recovered, or in an extreme condition, the module may be permanently destroyed.

Note 3: Vr Conditions: Zener Diode 20mA

3.2. Typical Operation Conditions

(Note 1)

Item	Symbol	Values			Unit	Remark
		Min.	Typ.	Max.		
Power voltage	DV _{DD}	3.0	3.3	3.6	V	Note 2
	AV _{DD}	10.2	10.4	10.6	V	
	V _{GH}	15.3	16.0	16.7	V	
	V _{GL}	-7.7	-7.0	-6.3	V	
Input signal voltage	V _{COM}	-	4.1	-	V	(V1+V14)/2 =5.2V
	V1~V7	0.4 AV _{DD}	-	AV _{DD} -0.1	V	
	V8~V14	0.1	-	0.6 AV _{DD}	V	
Input logic high voltage	V _{IH}	0.7 DV _{DD}	-	DV _{DD}	V	Note 3
Input logic low voltage	V _{IL}	0	-	0.3 DV _{DD}	V	

Note 1: Be sure to apply DV_{DD} and V_{GL} to the LCD first, and then apply V_{GH}.

Note 2: DV_{DD} setting should match the signals output voltage (refer to Note 3) of customer's system board.

Note 3: POL, STVD, OEV, CKV, STVU, EDGSL, U/D, STHL, REV, DCLK, STHR, LD, R/L, R0~R5, G0~G5, B0~B5.

3.2.1. Current Consumption

Item	Symbol	Values			Unit	Remark
		Min.	Typ.	Max.		
Current for Driver	I_{GH}	-	0.2	0.5	mA	$V_{GH} = 16.0V$
	I_{GL}	-	0.2	1.0	mA	$V_{GL} = -7.0V$
	IDV_{DD}	-	5.0	10.0	mA	$DV_{DD} = 3.3V$
	$I_{AV_{DD}}$	-	40.0	50.0	mA	$AV_{DD} = 10.4V$

3.2.2. Backlight Driving Conditions

Item	Symbol	Values			Unit	Remark
		Min.	Typ.	Max.		
Voltage for LED Backlight	V_L	(9.3)	(9.9)	(10.5)	V	Note1
Current for LED Backlight	I_L	(170)	(180)	(200)	mA	
LED life time	-	20,000	-	-	Hr	Note 2

Note 1: The Voltage for LED Backlight is defined at $T_a=25^{\circ}C$ and $I_L = 180mA$.

Note 2: The "LED life time" is defined as the module brightness decrease to 50% original brightness at $T_a=25^{\circ}C$ and $I_L = 180mA$. The LED lifetime could be decreased if operating I_L is larger than 180 mA.

3.3. Power Sequence

1. Power on:

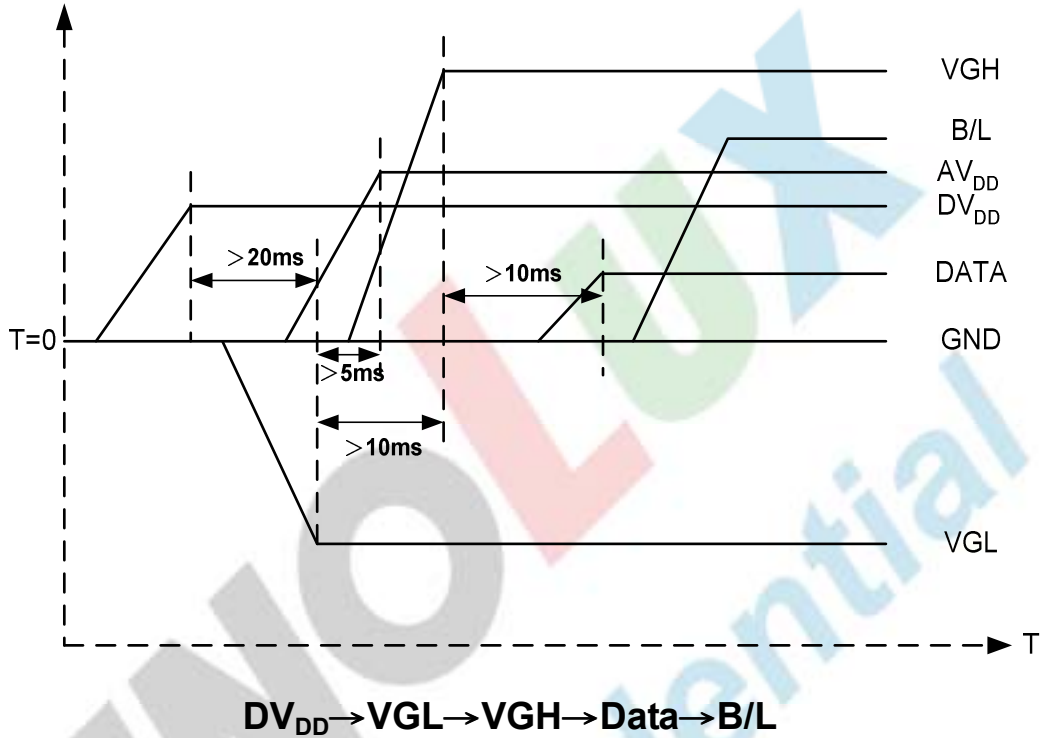

2. Power off:

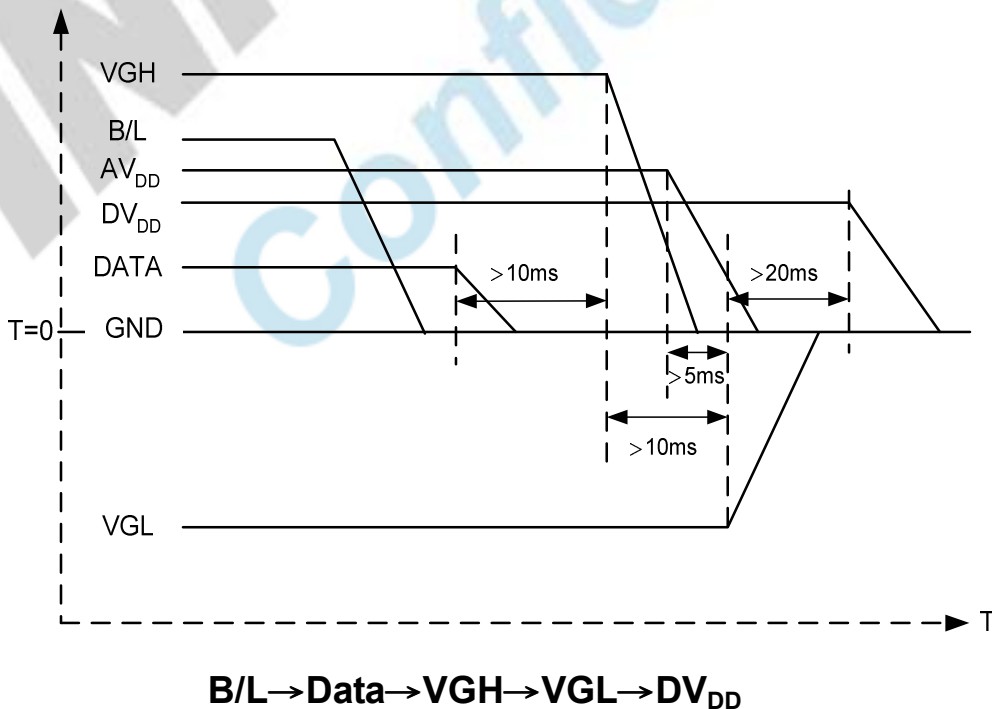

Note: Data include DCLK,POL,OE,CKV,STVU,STVD,STHL,STHR,LD,R0~R5,G0~G5,B0~B5

版權屬於群創所有。禁止任何未經授權的使用

The copyright belongs to InnoLux. Any unauthorized use is prohibited.

<http://www.BDTIC.com/InnoLux>

3.4. Timing Characteristics

3.4.1. Timing Conditions

Item	Symbol	Values			Unit	Remark
		Min.	Typ.	Max.		
DCLK frequency	Fdclk	-	40	45	MHz	
DCLK cycle	Tcph	22	25	-	ns	
DCLK pulse width	Tcw	8	-	-	ns	
Data set-up time	Tsu	4	-	-	ns	
Data hold time	Thd	2	-	-	ns	
Time that the last data to LD	Tld	1	-	-	Tcph	
Pulse width of LD	Twld	2	-	-	Tcph	
Time that LD to STHL/R	Tlds	5	-	-	Tcph	
POL set-up time	Tpsu	6	-	-	ns	
POL hold time	Tphd	6	-	-	ns	
CKV frequency	Fvclk	-	-	200	KHz	
CKV rise time	Trck	-	-	100	ns	
CKV falling time	Tfck	-	-	100	ns	
CKV pulse width	PWCLK	500	-	-	ns	
Horizontal display timing range	Tdh	-	800	-	Tcph	
Horizontal timing range	Th	-	1056	-	Tcph	
STVU/D setup time	Tsuv	200	-	-	ns	
STVU/D hold time	Thdv	300	-	-	ns	
STVU/D delay time	Tdt	-	-	500	ns	
Driver output delay time	Tdo	-	-	900	ns	

版權屬於群創所有，禁止任何未經授權的使用

The copyright belongs to InnoLux. Any unauthorized use is prohibited.

<http://www.BDTIC.com/InnoLux>

Output rise time	Ttlh	-	500	1000	ns	
Output falling time	Tthl	-	400	800	ns	
OEV pulse width	Twcl	1	-	-	us	
OEV to Driver output delay time	Toe	-	-	900	ns	
Horizontal lines per field	Tv	512	525	610	Tdh	
Vertical display timing range	Tvd	-	480	-	Tdh	

INNOLUX
Confidential

版權屬於群創所有，禁止任何未經授權的使用

The copyright belongs to InnoLux. Any unauthorized use is prohibited.

<http://www.BDTIC.com/InnoLux>

3.4.2. Timing Diagram

Timing Diagram1 (CHNSL="1", Default)

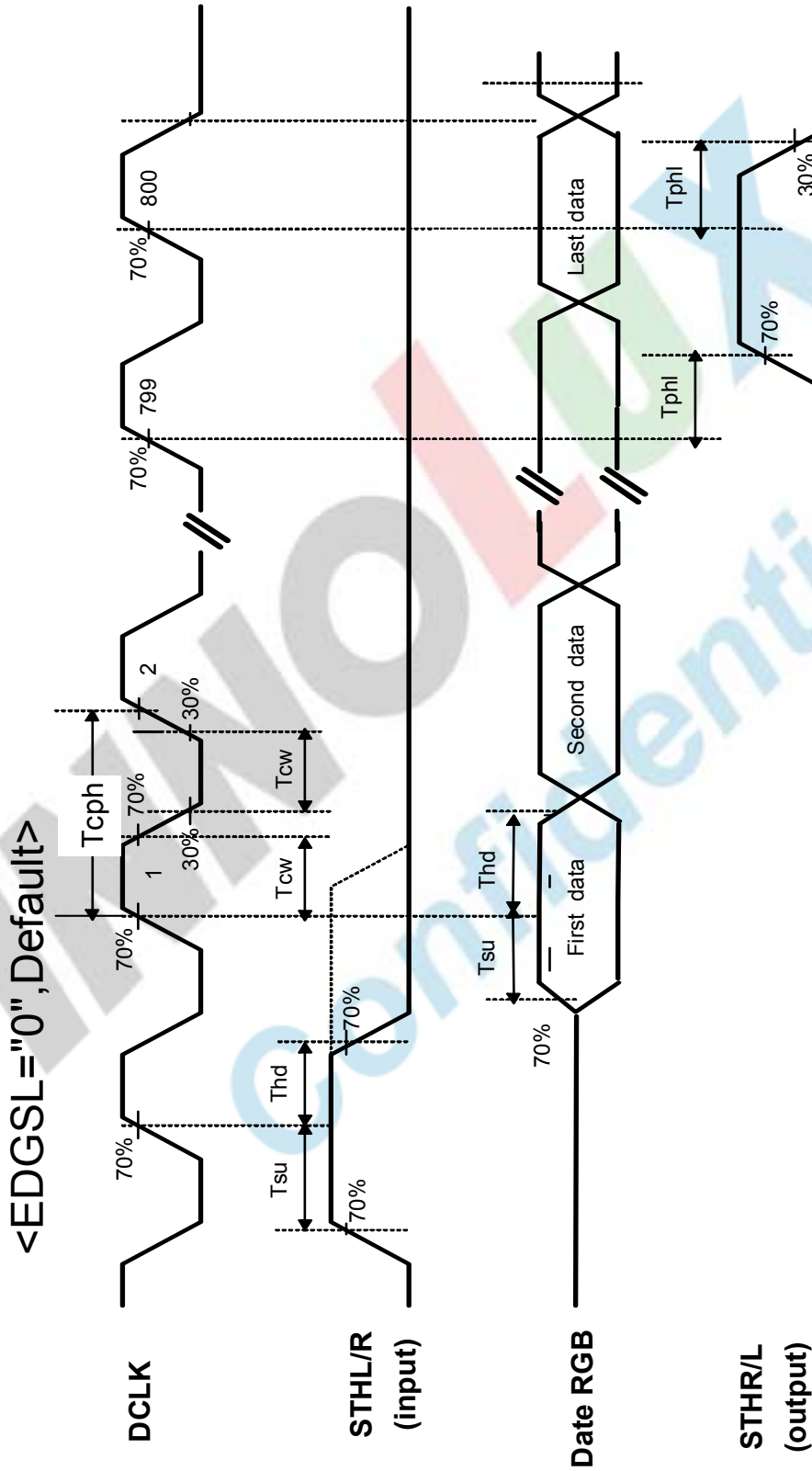

Fig.3-1 operation model 1

版權屬於群創所有，禁止任何未經授權的使用

The copyright belongs to InnoLux. Any unauthorized use is prohibited.

<http://www.BDTIC.com/InnoLux>

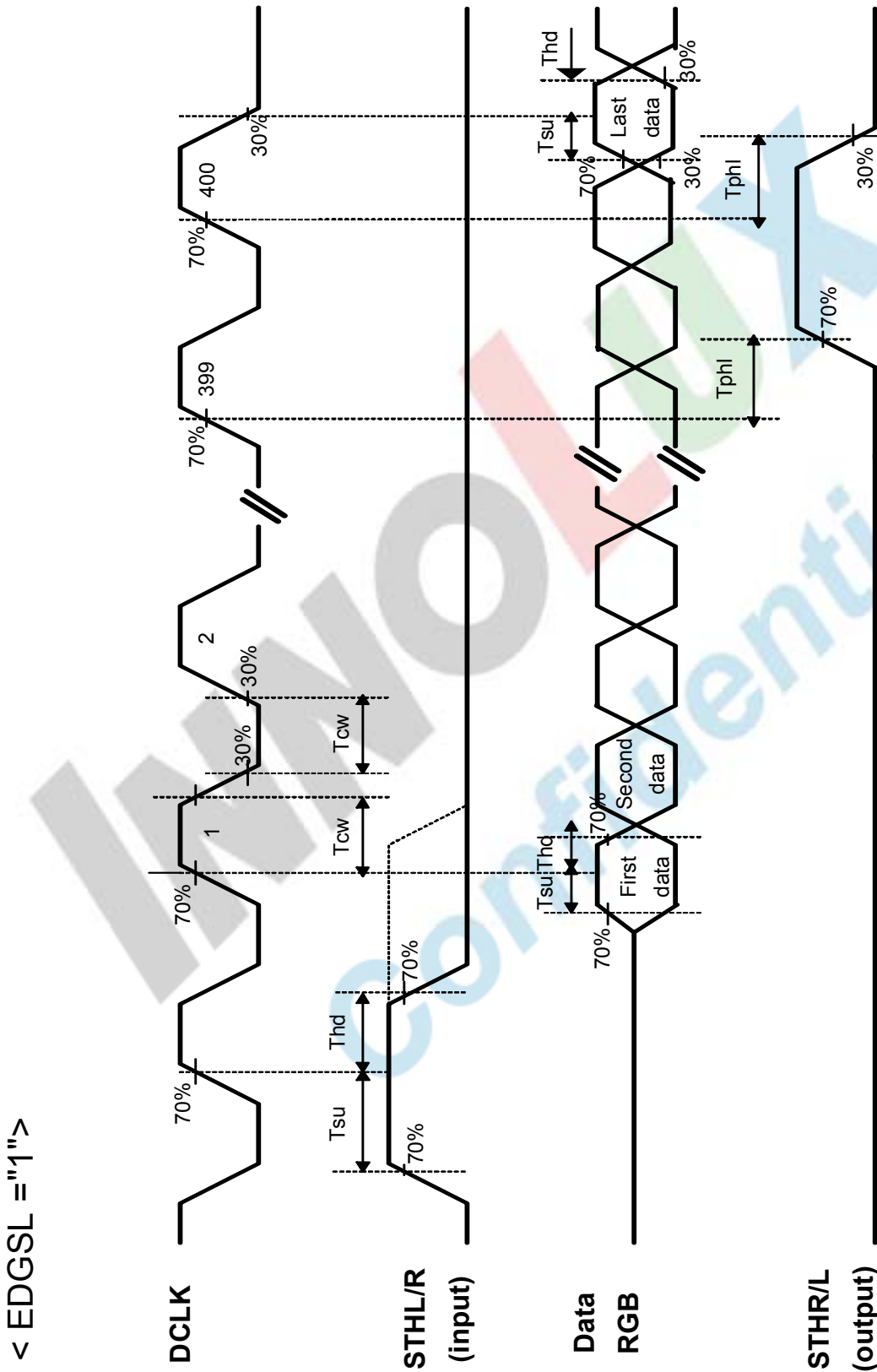

Fig.3-2 operation model 2

版權屬於群創所有，禁止任何未經授權的使用

The copyright belongs to InnoLux. Any unauthorized use is prohibited.

<http://www.BDTIC.com/InnoLux>

Timing Diagram 2

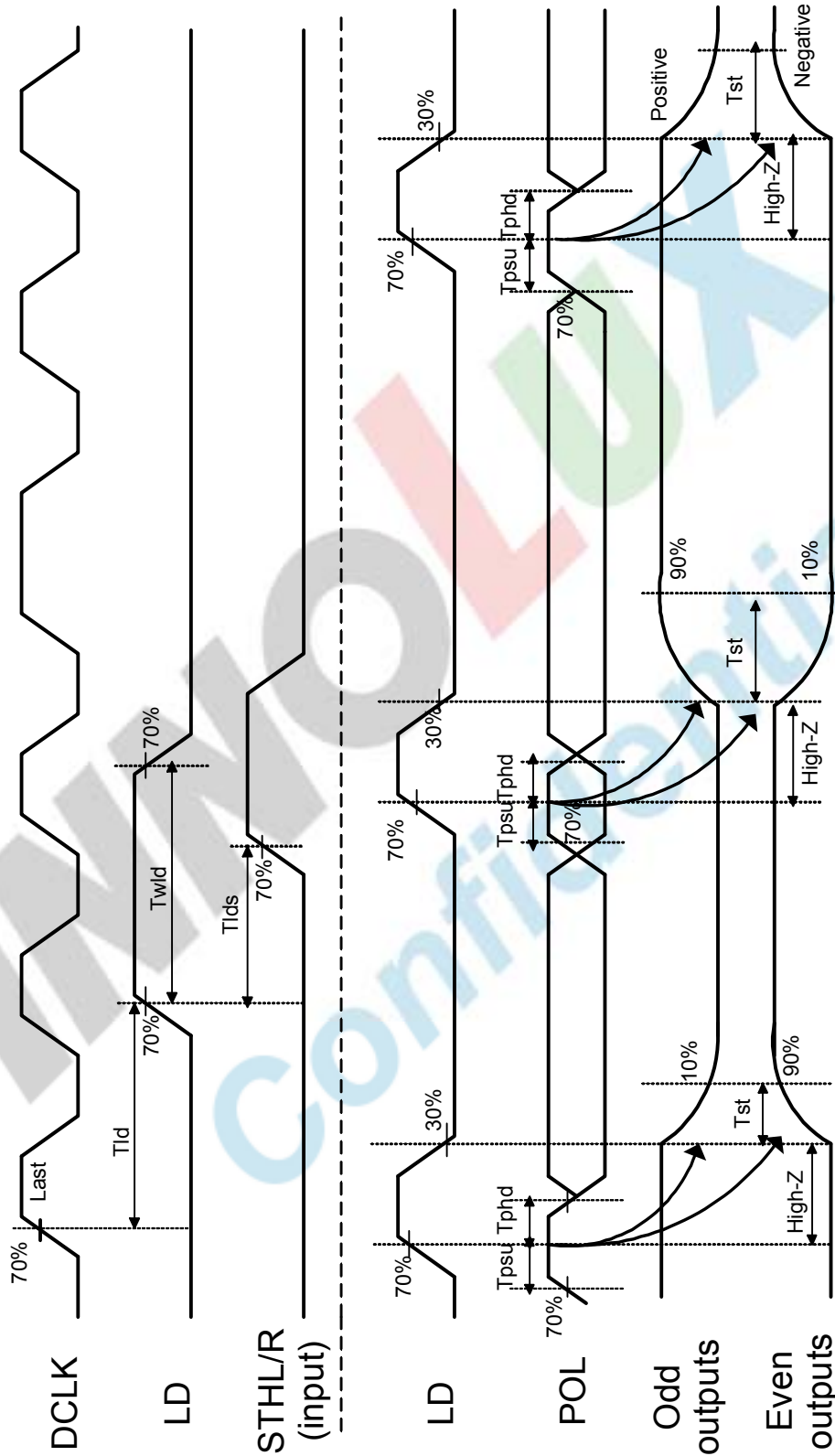

Fig.3-3 Horizontal timing 1

版權屬於群創所有，禁止任何未經授權的使用

The copyright belongs to InnoLux. Any unauthorized use is prohibited.

<http://www.BDTIC.com/InnoLux>

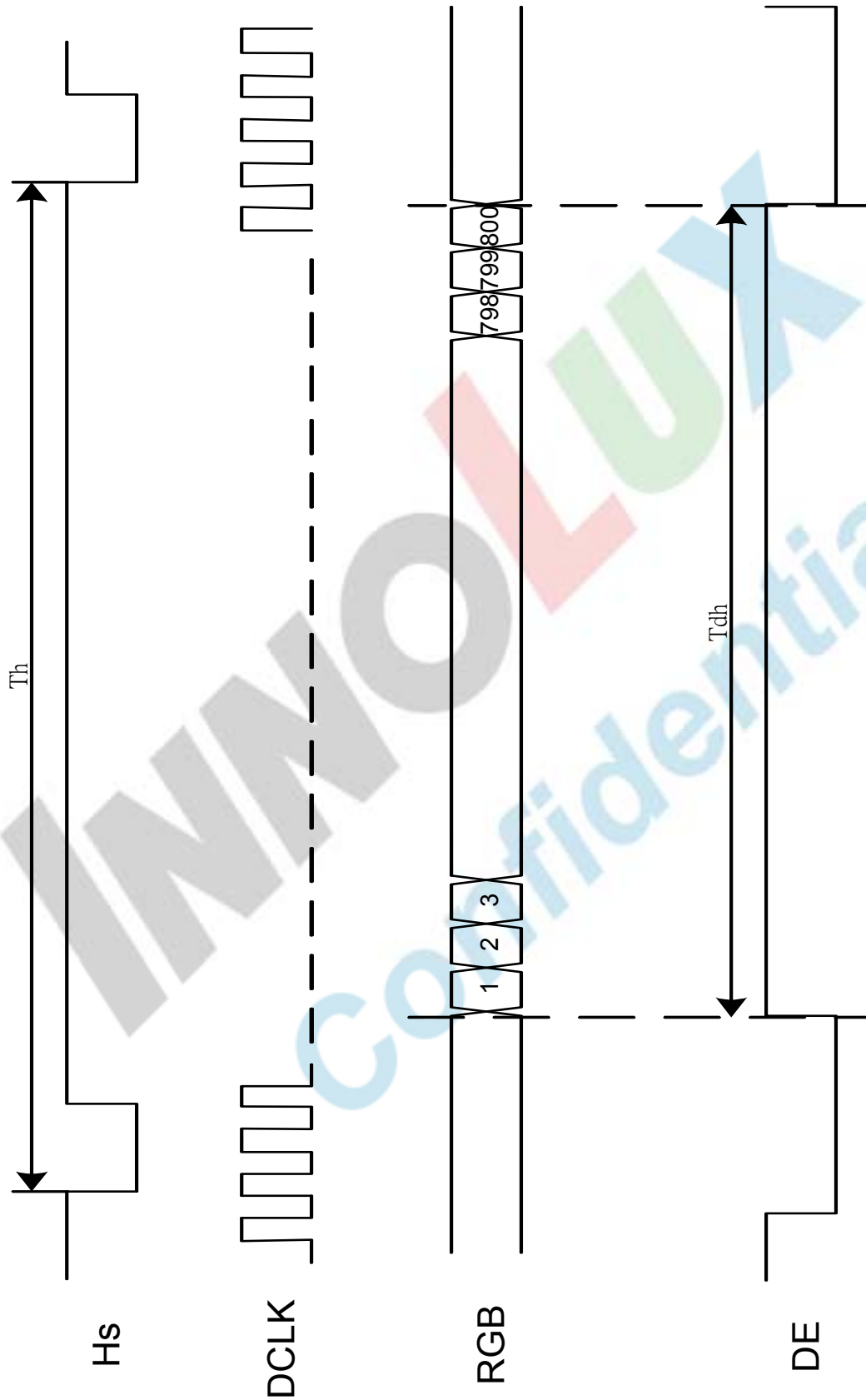

Fig.3-4 Horizontal timing 2

版權屬於群創所有，禁止任何未經授權的使用

The copyright belongs to InnoLux. Any unauthorized use is prohibited.

<http://www.BDTIC.com/InnoLux>

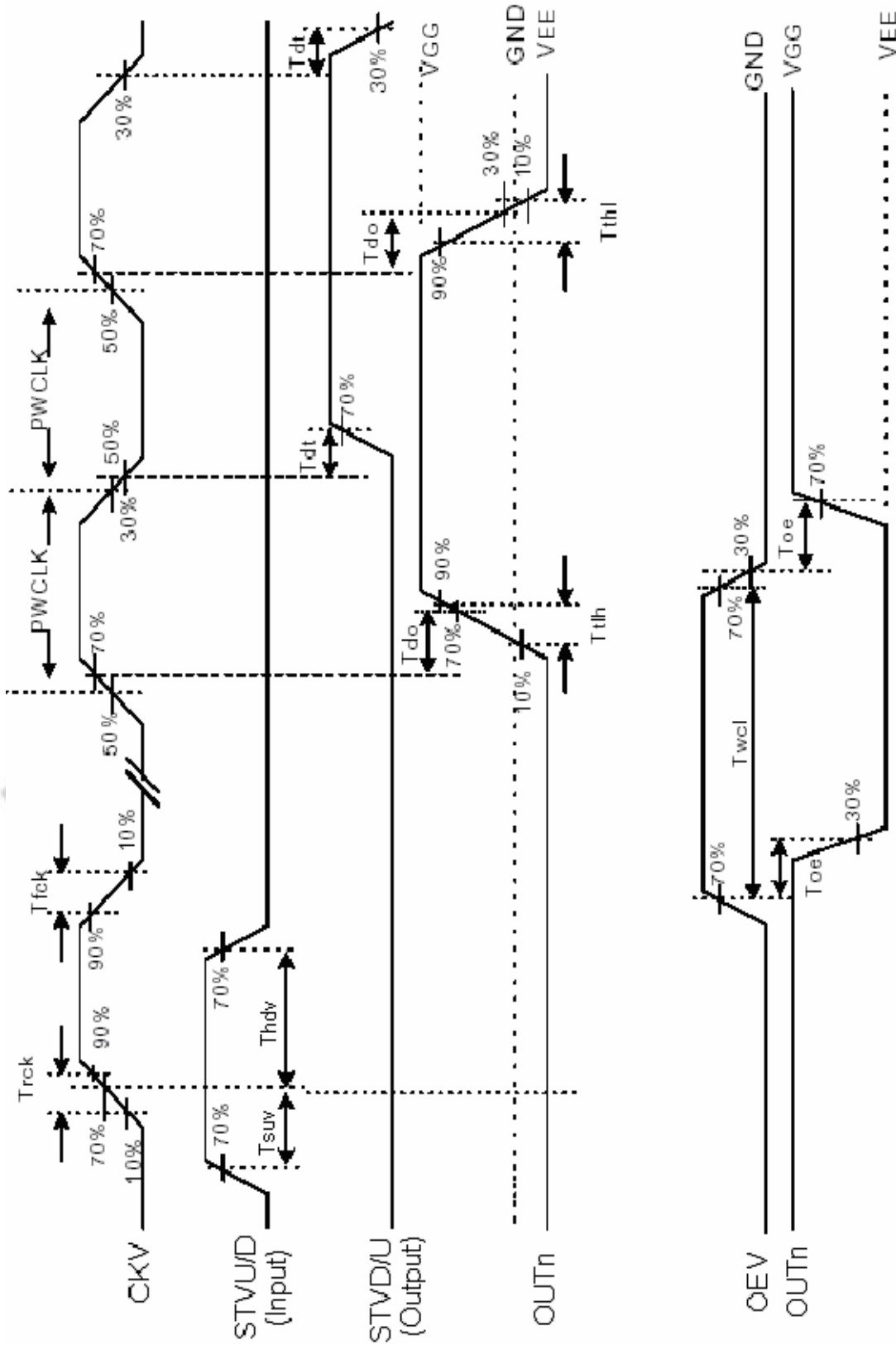

Fig.3-5 Vertical shift clock timing

版權屬於群創所有，禁止任何未經授權的使用

The copyright belongs to InnoLux. Any unauthorized use is prohibited.

<http://www.BDTIC.com/InnoLux>

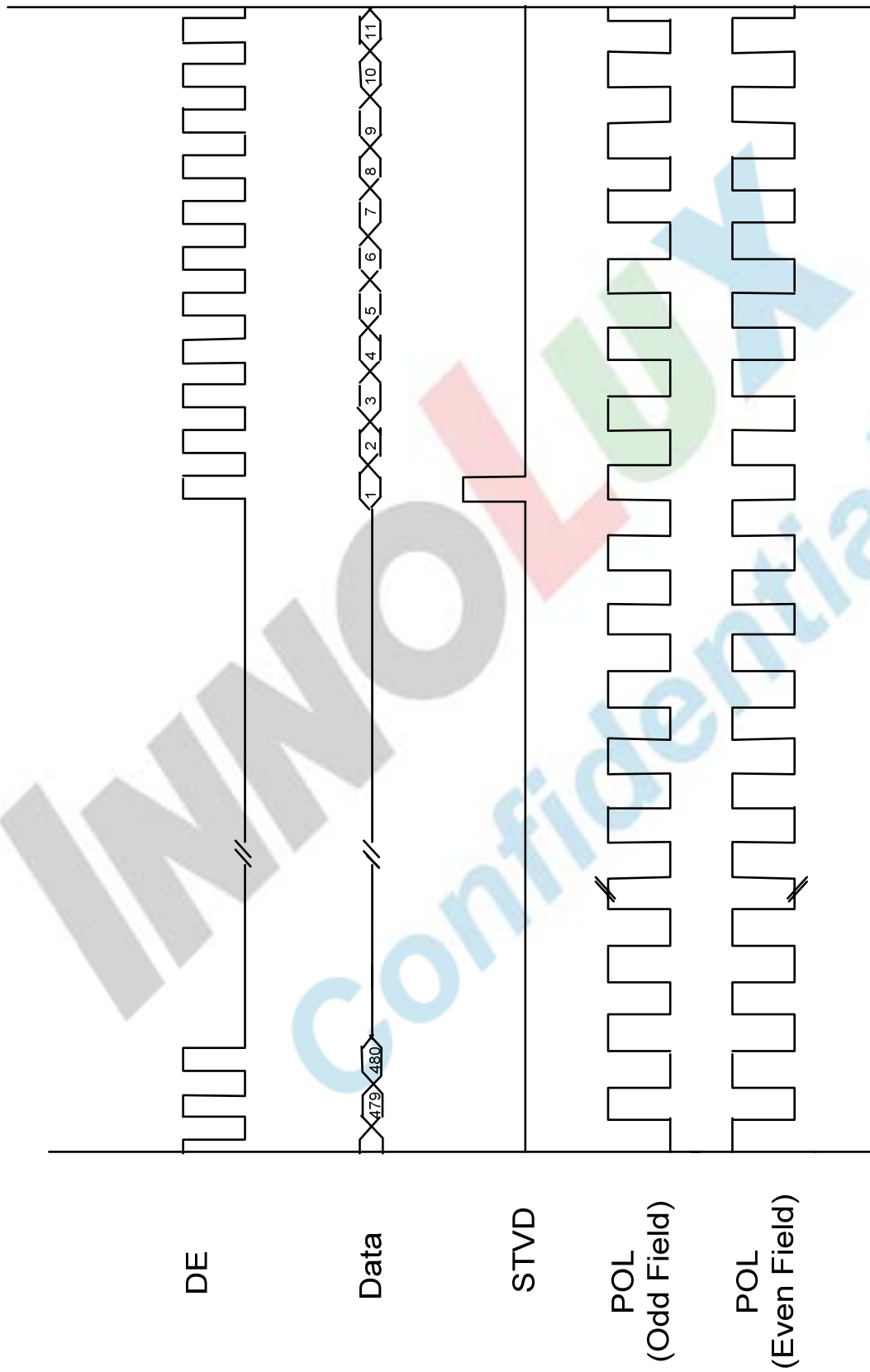

Fig.3-6 Vertical timing (from up to down)

版權屬於群創所有，禁止任何未經授權的使用

The copyright belongs to InnoLux. Any unauthorized use is prohibited.

<http://www.BDTIC.com/InnoLux>

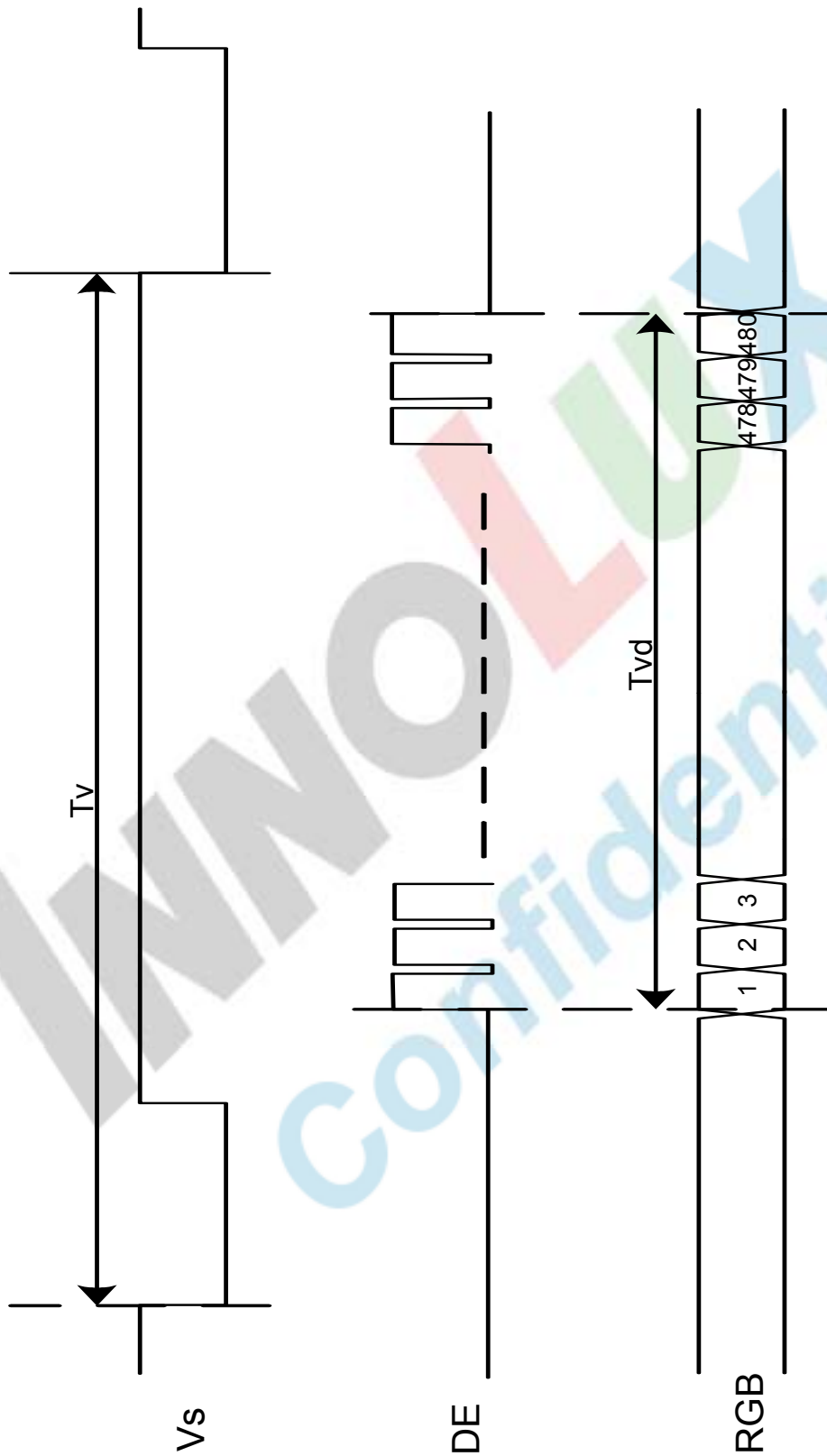

Fig.3-7 Vertical timing

版權屬於群創所有，禁止任何未經授權的使用

The copyright belongs to InnoLux. Any unauthorized use is prohibited.

<http://www.BDTIC.com/InnoLux>

4. Optical Specifications

Item	Symbol	Condition	Values			Unit	Remark
			Min.	Typ.	Max.		
Viewing angle (CR≥ 10)	θ_L	$\Phi=180^\circ$ (9 o'clock)	60	70	-	degree	Note 1
	θ_R	$\Phi=0^\circ$ (3 o'clock)	60	70	-		
	θ_T	$\Phi=90^\circ$ (12 o'clock)	40	50	-		
	θ_B	$\Phi=270^\circ$ (6 o'clock)	60	70	-		
Response time	T_{ON}	Normal $\theta=\Phi=0^\circ$	-	10	20	msec	Note 3
	T_{OFF}		-	15	30	msec	Note 3
Contrast ratio	CR		400	500	-	-	Note 4
Color chromaticity	W_X		0.26	0.31	0.36	-	Note 2 Note 5 Note 6
	W_Y		0.28	0.33	0.38	-	
Luminance	L		360	450	-	cd/m ²	Note 6
Luminance uniformity	Y_U		70	75	-	%	Note 7

Test Conditions:

1. $DV_{DD} = 3.3V$, $I_L = 180mA$ (Backlight current), the ambient temperature is $25^\circ C$.
2. The test systems refer to Note 2.

Note 1: Definition of viewing angle range

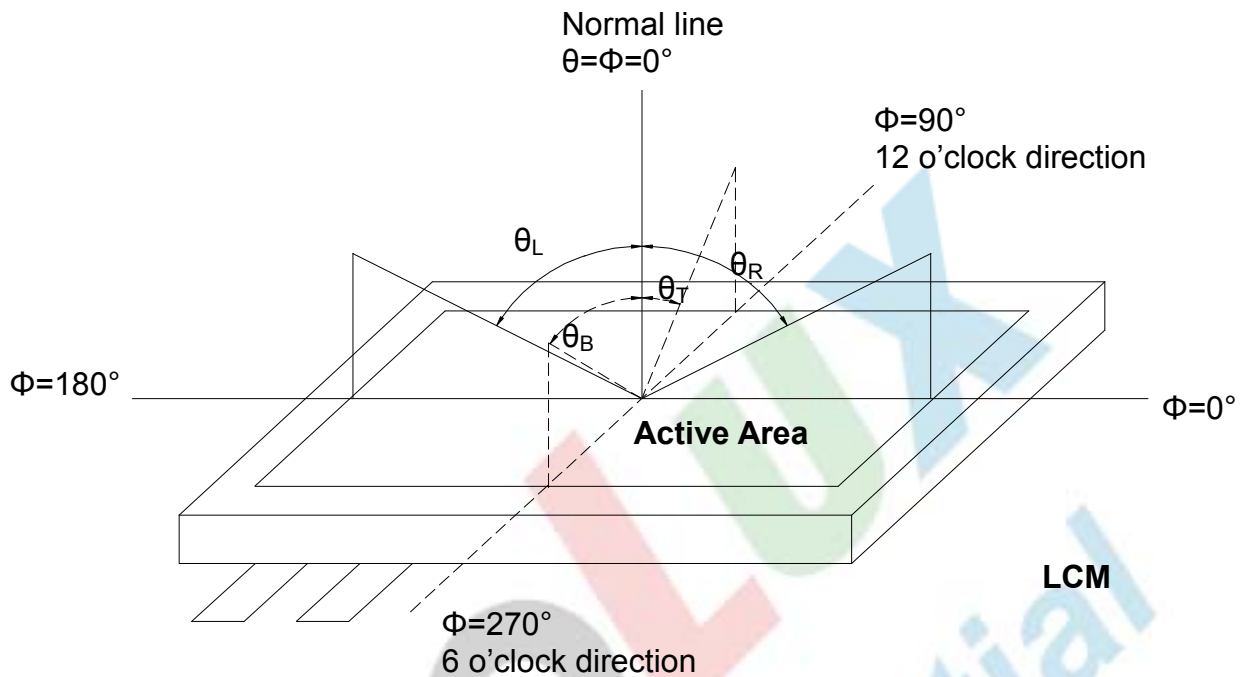

Fig. 4-1 Definition of viewing angle

Note 2: Definition of optical measurement system.

The optical characteristics should be measured in dark room. After 30 minutes operation, the optical properties are measured at the center point of the LCD screen. (Response time is measured by Photo detector TOPCON BM-7, other items are measured by BM-5A/Field of view: 1° /Height: 500mm.)

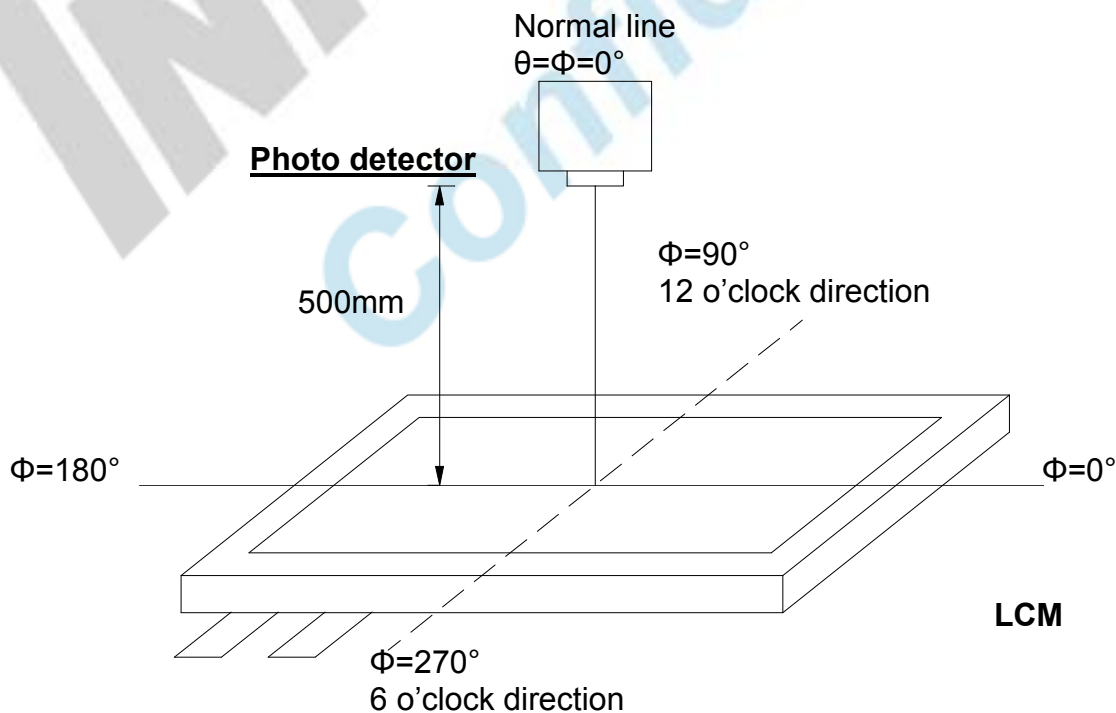

Fig. 4-2 Optical measurement system setup

版權屬於群創所有，禁止任何未經授權的使用

The copyright belongs to InnoLux. Any unauthorized use is prohibited.

<http://www.BDTIC.com/InnoLux>

Note 3: Definition of Response time

The response time is defined as the LCD optical switching time interval between "White" state and "Black" state. Rise time (T_{ON}) is the time between photo detector output intensity changed from 90% to 10%. And fall time (T_{OFF}) is the time between photo detector output intensity changed from 10% to 90%.

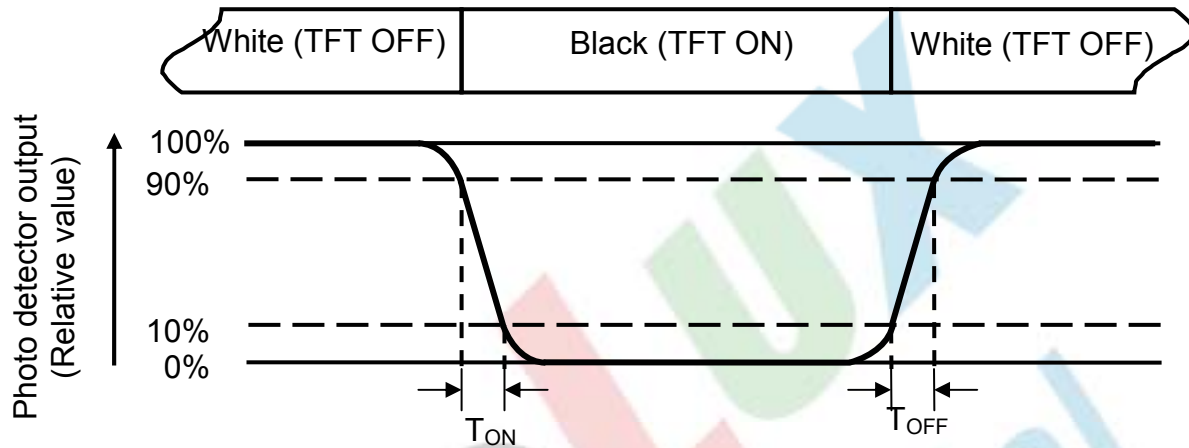

Fig. 4-3 Definition of response time

Note 4: Definition of contrast ratio

$$\text{Contrast ratio (CR)} = \frac{\text{Luminance measured when LCD on the "White" state}}{\text{Luminance measured when LCD on the "Black" state}}$$

Note 5: Definition of color chromaticity (CIE1931)

Color coordinates measured at center point of LCD.

Note 6: All input terminals LCD panel must be ground while measuring the center area of the panel. The LED driving condition is $I_L=180\text{mA}$.

Note 7: Definition of Luminance Uniformity

Active area is divided into 9 measuring areas (Refer to Fig. 4-4).Every measuring point is placed at the center of each measuring area.

$$Luminance\ Uniformity\ (Yu) = \frac{B_{min}}{B_{max}}$$

L-----Active area length W----- Active area width

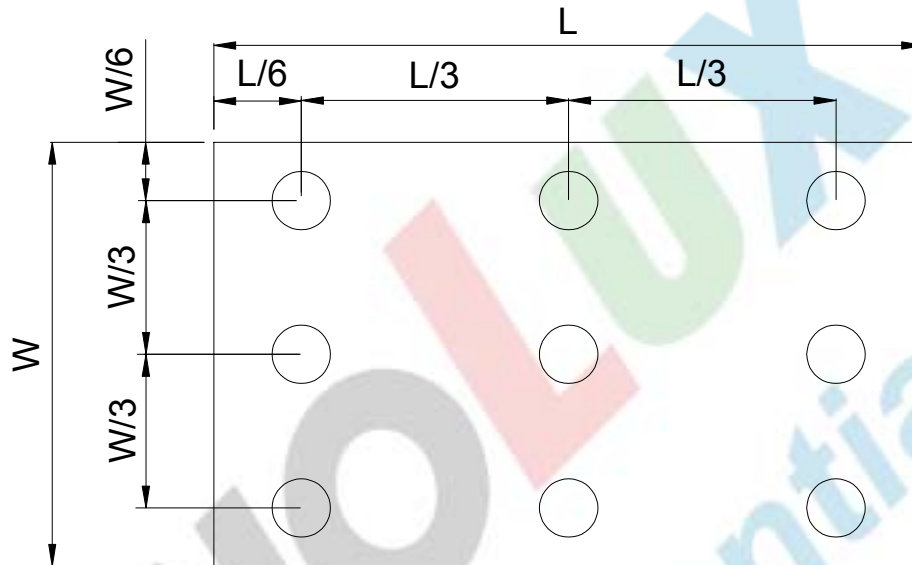

Fig. 4-4 Definition of measuring points

B_{max} : The measured maximum luminance of all measurement position.

B_{min} : The measured minimum luminance of all measurement position.

5. Reliability Test Items

(Note3)

Item	Test Conditions	Remark
High Temperature Storage	Ta = 85°C 240 hrs	Note 1,Note 4
Low Temperature Storage	Ta = -30°C 240hrs	Note 1,Note 4
High Temperature Operation	Ts = 85°C 240hrs	Note 2,Note 4
Low Temperature Operation	Ta = -30°C 240hrs	Note 1,Note 4
Operate at High Temperature and Humidity	+60°C, 90%RH max. 240 hrs	Note 4
Thermal Shock	-30°C/30 min ~ +85°C/30 min for a total 100 cycles, Start with cold temperature and end with high temperature	Note 4
Vibration Test	Frequency range:10~55Hz Stroke:1.5mm Sweep:10Hz~55Hz~10Hz 2 hours for each direction of X. Y. Z. (6 hours for total)	
Mechanical Shock	100G 6ms,±X, ±Y, ±Z 3 times for each direction	
Package Vibration Test	Random Vibration : 0.015G*G/Hz from 5-200HZ, -6dB/Octave from 200-500HZ 2 hours for each direction of X. Y. Z. (6 hours for total)	
Package Drop Test	Height:60 cm 1 corner, 3 edges, 6 surfaces	
Electro Static Discharge	± 2KV, Human Body Mode, 100pF/1500Ω	

Note 1: Ta is the ambient temperature of samples.

Note 2: Ts is the temperature of panel's surface.

Note 3: In the standard condition, there shall be no practical problem that may affect the display function. After the reliability test, the product only guarantees operation, but doesn't guarantee all the cosmetic specification.

Note 4: Before cosmetic and function test, the product must have enough recovery time, at least 2 hours at room temperature.

版權屬於群創所有，禁止任何未經授權的使用

The copyright belongs to InnoLux. Any unauthorized use is prohibited.

<http://www.BDTIC.com/InnoLux>

6. General Precautions

6.1. Safety

Liquid crystal is poisonous. Do not put it in your mouth. If liquid crystal touches your skin or clothes, wash it off immediately by using soap and water.

6.2. Handling

1. The LCD panel is plate glass. Do not subject the panel to mechanical shock or to excessive force on its surface.
2. The polarizer attached to the display is easily damaged. Please handle it carefully to avoid scratch or other damages.
3. To avoid contamination on the display surface, do not touch the module surface with bare hands.
4. Keep a space so that the LCD panels do not touch other components.
5. Put cover board such as acrylic board on the surface of LCD panel to protect panel from damages.
6. Transparent electrodes may be disconnected if you use the LCD panel under environmental conditions where the condensation of dew occurs.
7. Do not leave module in direct sunlight to avoid malfunction of the ICs.

6.3. Static Electricity

1. Be sure to ground module before turning on power or operating module.
2. Do not apply voltage which exceeds the absolute maximum rating value.

6.4. Storage

1. Store the module in a dark room where must keep at $25\pm 10^{\circ}\text{C}$ and 65%RH or less.
2. Do not store the module in surroundings containing organic solvent or corrosive gas.
3. Store the module in an anti-electrostatic container or bag.

6.5. Cleaning

1. Do not wipe the polarizer with dry cloth. It might cause scratch.
2. Only use a soft sloth with IPA to wipe the polarizer, other chemicals might permanent damage to the polarizer.

7. Mechanical Drawing

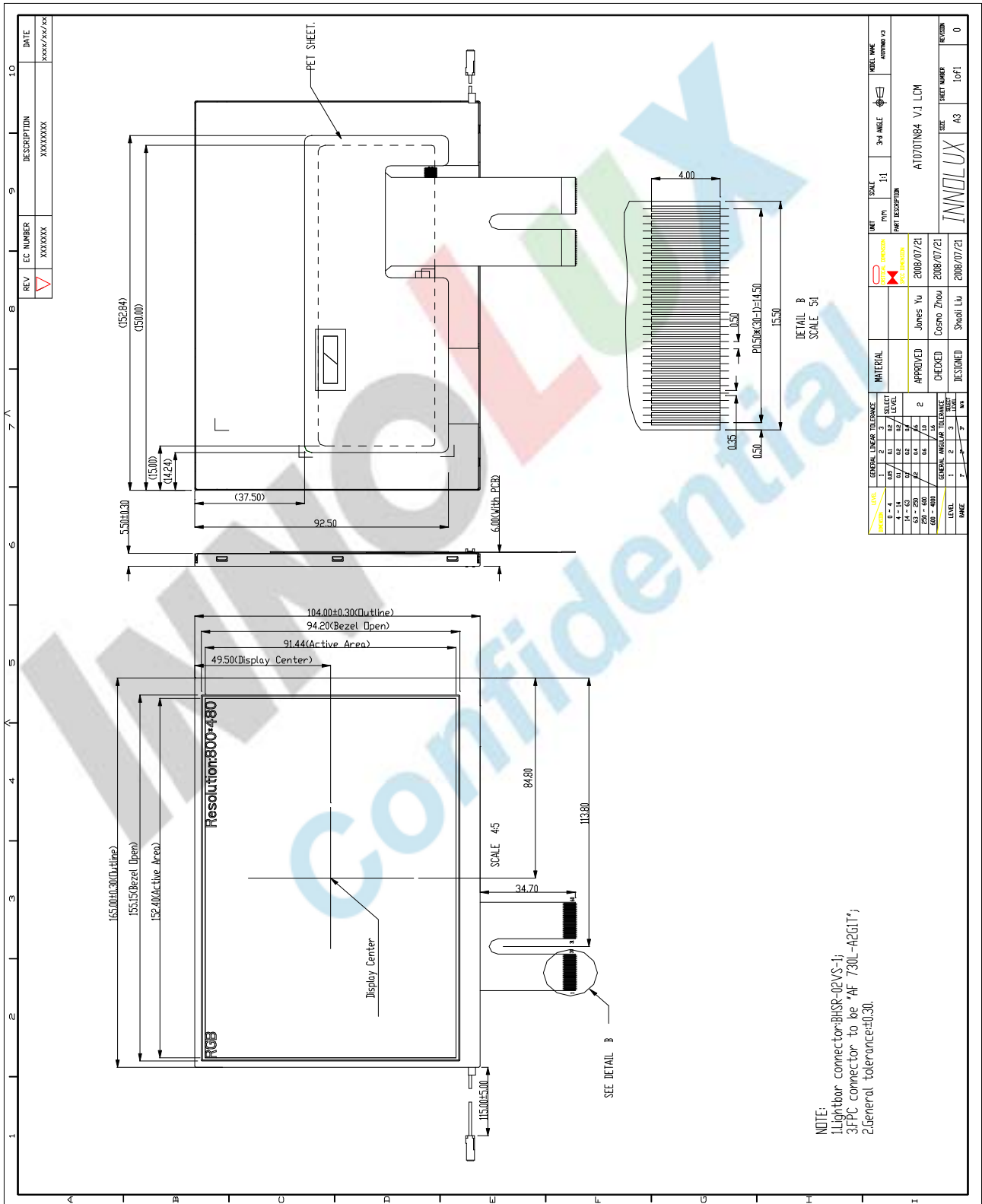

NOTE:
 1. Lightbar connector: BHSR-02VS-1;
 3. FPC connector to be 'AF 730L-A2G1T';
 2. General tolerance: ±0.30.

版權屬於群創所有，禁止任何未經授權的使用

The copyright belongs to InnoLux. Any unauthorized use is prohibited.

<http://www.BDTIC.com/InnoLux>

8. Package Drawing

8.1. Packaging Material Table

No.	Item	Model (Material)	Dimensions(mm)	Unit Weight (kg)	Quantity	Remark
1	LCM Module	AT070TN84 V.1	165 × 104 × 5.5	TBD	50pcs	
2	Partition	BC Corrugated Paper	512 × 349 × 226	1.466	1 set	
3	Corrugated Bar	BC Corrugated Paper	512 × 162	0.046	4 set	
4	Corrugated Board	BC Corrugated Paper	510 × 343	0.130	1pcs	
5	Dust-Proof Bag	PE	700 × 530	0.048	1 pcs	
6	A/S Bag	PE	180 × 160 × 0.05	0.002	50 pcs	
7	Carton	Corrugated paper	530 × 355 × 255	1.100	1 pcs	
8	Total weight	TBD				

8.2. Packaging Quantity

Total LCM quantity in Carton: no. of Partition	2 Rows	x	quantity per Row	25	= 50
--	--------	---	------------------	----	------

8.3. Packaging Drawing

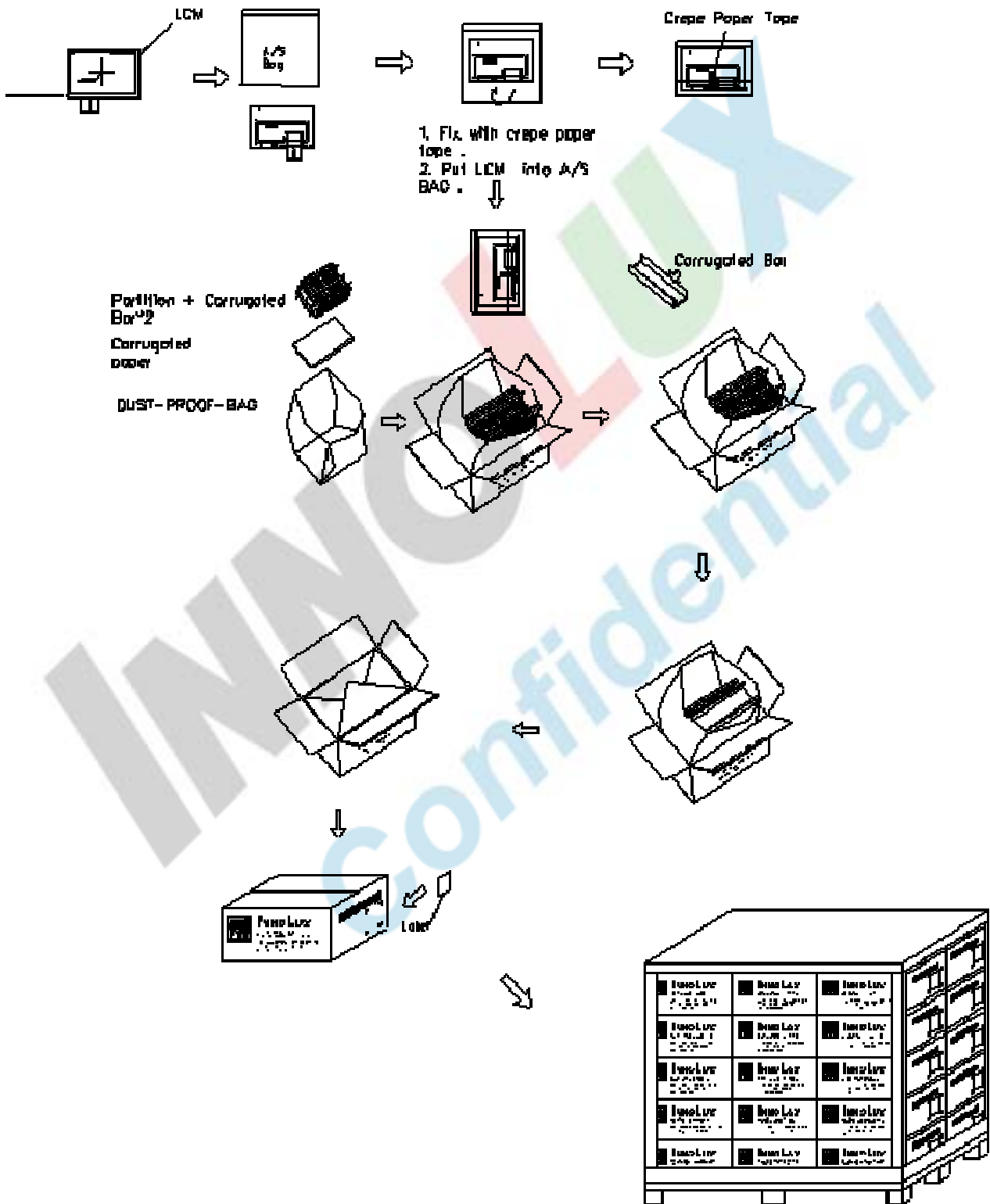

版權屬於群創所有，禁止任何未經授權的使用

The copyright belongs to InnoLux. Any unauthorized use is prohibited.

<http://www.BDTIC.com/InnoLux>