

Features

- **AUDIO CODEC**
 - 100dB Dynamic Range Stereo Audio DAC - 8 to 96 kHz sampling frequency
 - 96dB Dynamic Range Stereo Audio ADC - 8 to 96 kHz sampling frequency
 - 16 / 32 Ohms headset amplifier with capless operation
 - SNR: 97 dB A-Weighted
 - THD: -60 dB (16Ohms / 20mW / 3.3V supply)
 - Maximum output power: 55mW (16Ohms / 3.3V supply)
 - Stereo line inputs, stereo auxiliary inputs
 - Stereo microphone inputs with bias generator for electret device
 - Low power Analog Bypass mode (Line / Aux in to Headset Out)
 - Low power Analog sidetone mode (Microphone in to Headset Out)
 - Automatic Audio path control with smooth fade in / fade out operation
 - I²S port
 - Master / Slave Operation
 - I²S / Left / Right justified modes
 - 16 / 18 / 20 / 24 bit operation
- **6x SUPPLY CHANNEL VOLTAGE REGULATORS**
 - DCDC0:
 - 1.85V - 600mA. 0.8 to 3.6V / 50mV step.
 - 2 MHz switching buck regulator
 - Fast load transient response - PWM / PFM modes.
 - Efficiency up to 92%
 - DCDC1:
 - 1.2V - 600mA. 0.8 to 3.6V / 50mV step.
 - 2 MHz switching buck regulator
 - Fast load transient response - PWM / PFM modes.
 - Efficiency up to 90%
 - LDO2: 1V - 300mA. 0.8 to 1.35V / 50mV step - Fast transient response
 - LDO3: 3.3V - 200mA. 2.7 to 3.6V / 50mV step - Fast transient response
 - LDO4: 3.3V - 200mA. 2.7 to 3.6V / 50mV step - Audio codec supply
 - LDO5: 2.5V - 10mA - Backup battery charger and RTC supply
- **LOW CONSUMPTION POWER MANAGER**
 - 2.5V - 5.5V VIN Operation
 - 20uA typical consumption OFF mode
 - VIN monitor, CPU supplies monitor
 - Die temperature and over-current protections
 - Reset and Interrupt generation
 - Automatic Voltage Ramping on supply channels for DVS applications
 - Standby mode with selectable supplies OFF
- **RTC**
 - Ultra Low power crystal oscillator (<1uA typ.)
 - Wake up function with programmable alarm or selectable inputs
- 10-b / 300kS/s ADC with 4 external / 6 internal selectable inputs
- Two-Wire Interface for PMU and Audio controls
- Available in 7.5 x 7.5 x 0.9 mm 64-pin QFN Package
- Applications: Multimedia, Audio + Supply solution for MPU+DDR2 designs.



Power Management and Analog Companions (PMAAC)

AT73C246 6 Supply Channel PMU With Audio Codec

11050A-PMAAC-07-Apr-10



1. Description

The AT73C246 is an integrated high performance Power Management and Audio IC. It is specifically designed for advanced technology application processors with complex and low voltage supplies targeting audio applications from low to high end. This System-on-Chip allows significant savings in both cost and board area over previous discrete solutions.

Directly operated from a 2.9V to 5.5V input voltage, the PMU generates a set of 4 regulated power supplies and an associated delayed reset signal. These 4 voltages are built up with 2 high efficiency DCDC buck converters and 2 low noise LDOs. Featuring ultra fast transient responses and integrating automatic voltage scaling function, these supplies perfectly fit with modern low voltage MCU cores and memory supplies (DDR, Flash, ...). An additional 200mA LDO under software control is provided for auxiliary application functions. The high performances of this LDO (high PSRR, low noise, fast transient response) makes it ideal for analog front-ends (Audio, RF...) as well digital peripherals.

Aside from the PMU, the AT73C246 integrates a complete state-of-the art low power audio codec with headphone amplifier. On the input side, a stereo microphone preamplifier with differential or single ended connection (MICDIFF / MIC) and 2 selectable stereo inputs (LINE / AUX) are directed to a 96dB Dynamic Range stereo audio ADC through an input mixer. On the output side a 100dB dynamic range stereo audio DAC drives, through an output mixer, a 60 mW stereo headphone amplifier which comes along with a VCM buffer. This VCM buffer allows to save two large on-board coupling capacitors for area constrained applications. Additionally two fully analog paths called bypass and sidetone from line / aux and microphone inputs to headphone outputs allow to reduce the audio power consumption to minimum when needed.

The PMU is complemented with a low power RTC system including a recharging LDO, a crystal oscillator and a programmable alarm that is fully integrated in the PMU digital core. Thus, the RTC function is able to wake up the PMU, i.e the regulated power supplies, at a programmed instant.

Also, a 10-bit ADC equipped with a 10:1 analog multiplexer is provided to the application to perform voltage measurements.

Finally, to reduce power consumption to minimum, the PMU features a flexible STANDBY mode where the MCU is placed in reset state with selectable supplies ON, OFF or in low-power mode. Power consumption in OFF mode is typically 20uA.

2. Block Diagram

Figure 2-1. AT73C246 functional block diagram

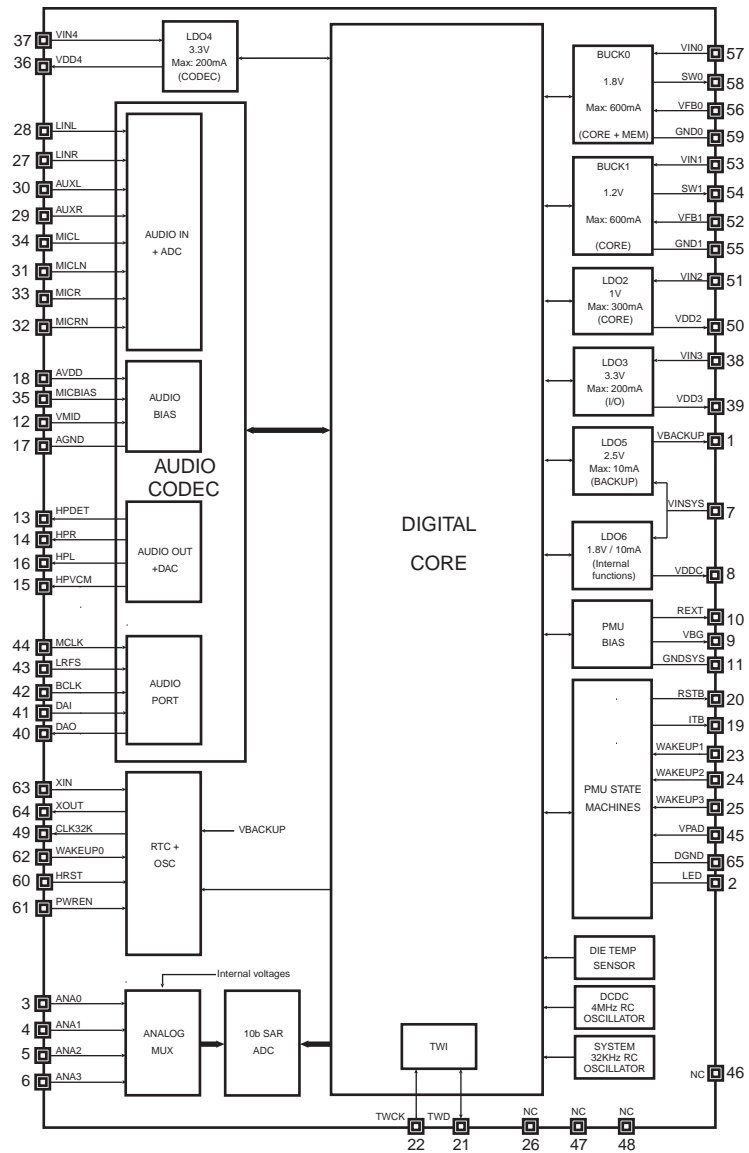

3. Package and Pinout

Figure 3-1. AT73C246 QFN64 package pinout - Top view

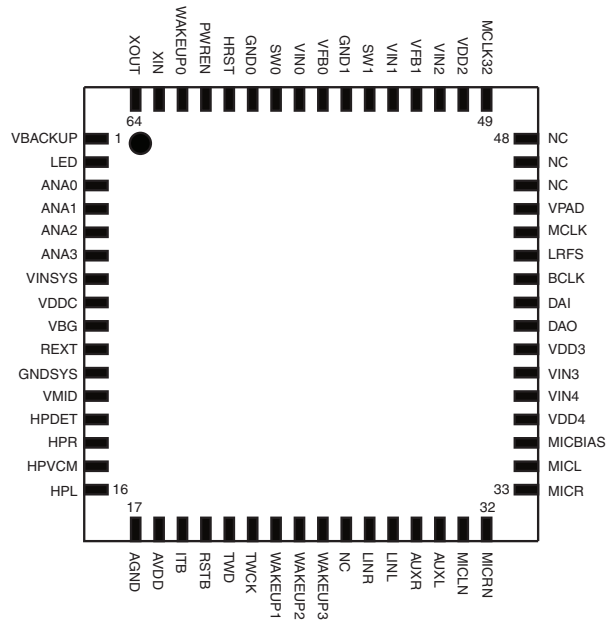

4. Pin Description

Table 4-1. Pin Description

Pin Name	I/O	Pin Number	Type	Function
VBACKUP	Output	1	Analog	RTC supply
LED	Output	2	Digital	Output for blinking led. Leave not connected if a LED is not wired.
ANA0	Input	3	Analog	Measurement input 0
ANA1	Input	4	Analog	Measurement Input 1
ANA2	Input	5	Analog	Measurement Input 2
ANA3	Input	6	Analog	Measurement Input 3
VINSYS	Input	7	Power	PMU core supply
VDDC	Output	8	Analog	PMU / Audio digital supply. Internal use only. No resistive load.
VBG	Output	9	Analog	PMU Voltage reference
REXT	Output	10	Analog	Resistor connection for PMU bias current
GNDSYS	GND	11	Analog	PMU ground
VMID	Output	12	Analog	Audio Codec Mid-Supply reference
HPDET	Input	13	Analog	Headset detector
HPR	Output	14	Analog	Headset output right
HPVCM	Output	15	Analog	Headset virtual ground output
HPL	Output	16	Analog	Headset output left
AGND	GND	17	Analog	Audio Codec ground
AVDD	Input	18	Power	Audio Codec supply input
ITB	Output	19	Digital	Interrupt request - Active low - Open-drain
RSTB	Output	20	Digital	CPU reset - Active low - Open drain
TWD	Input/Output	21	Digital	Two Wire Interface - Data
TWCK	Input	22	Digital	Two Wire Interface - Clock
WAKEUP1	Input	23	Digital	Wake up 1 Input - VPAD level - 100k Pull down
WAKEUP2	Input	24	Digital	Wake up 2 Input - VPAD level - 100k Pull down
WAKEUP3	Input	25	Digital	Wake up 3 input - VPAD level - 100k Pull down
NC	-	26	-	Connect to DGND
LINR	Input	27	Analog	Audio Line input right
LINL	Input	28	Analog	Audio Line input left
AUXR	Input	29	Analog	Audio auxiliary input right
AUXL	Input	30	Analog	Audio auxiliary input left

Table 4-1. Pin Description

Pin Name	I/O	Pin Number	Type	Function
MICLN	Input	31	Analog	Audio negative microphone input left
MICRN	Input	32	Analog	Audio negative microphone input right
MICR	Input	33	Analog	Audio positive microphone input right
MICL	Input	34	Analog	Audio positive microphone input left
MICBIAS	Output	35	Analog	Voltage bias for electret microphone
VDD4	Output	36	Power	LDO4 output - 3.3V typ
VIN4	Input	37	Analog	LDO4 input
VIN3	Input	38	Power	LDO3 input
VDD3	Output	39	Analog	LDO3 output - 3.3V typ
DAO	Output	40	Digital	Digital audio port data output
DAI	Input	41	Digital	Digital audio port data input
BCLK	Input/Output	42	Digital	Digital audio port bit clock
LRFS	Input/Output	43	Digital	Digital audio port left/right clock
MCLK	Input	44	Digital	Audio codec master clock input
VPAD	Input	45	Power	PMU I/O ring supply
NC	-	46	-	Leave open
NC	-	47	-	Connect to DGND
NC	-	48	-	Connect to DGND
MCLK32	Output	49	Digital	RTC clock output - VPAD level
VDD2	Output	50	Analog	LDO2 output
VIN2	Input	51	Power	LDO2 input
VFB1	Input	52	Analog	DCDC1 Voltage feedback input
VIN1	Input	53	Power	DCDC1 power stage supply
SW1	Output	54	Analog	DCDC1 power stage output
GND1	Ground	55	Analog	DCDC1 power stage ground
VFB0	Input	56	Analog	DCDC0 Voltage feedback input
VIN0	Input	57	Analog	DCDC0 power stage supply
SW0	Output	58	Analog	DCDC0 power stage output
GND0	Ground	59	Analog	DCDC0 power stage ground
HRST	Input	60	Digital	Hard reset - VBACKUP level - 100k Pull down
PWREN	Input	61	Digital	Power on/off - VBACKUP level - 100k Pull down
WAKEUP0	Input	62	Digital	Wake up 0 input - VBACKUP level - 100k Pull down

Table 4-1. Pin Description

Pin Name	I/O	Pin Number	Type	Function
XIN	Input	63	Analog	RTC crystal oscillator input
XOUT	Output	64	Analog	RTC crystal oscillator output
DGND	Ground	65	Analog	PMU digital ground + Thermal pad.

5. Application Block Diagram

Figure 5-1. AT73C246 Application Block Diagram

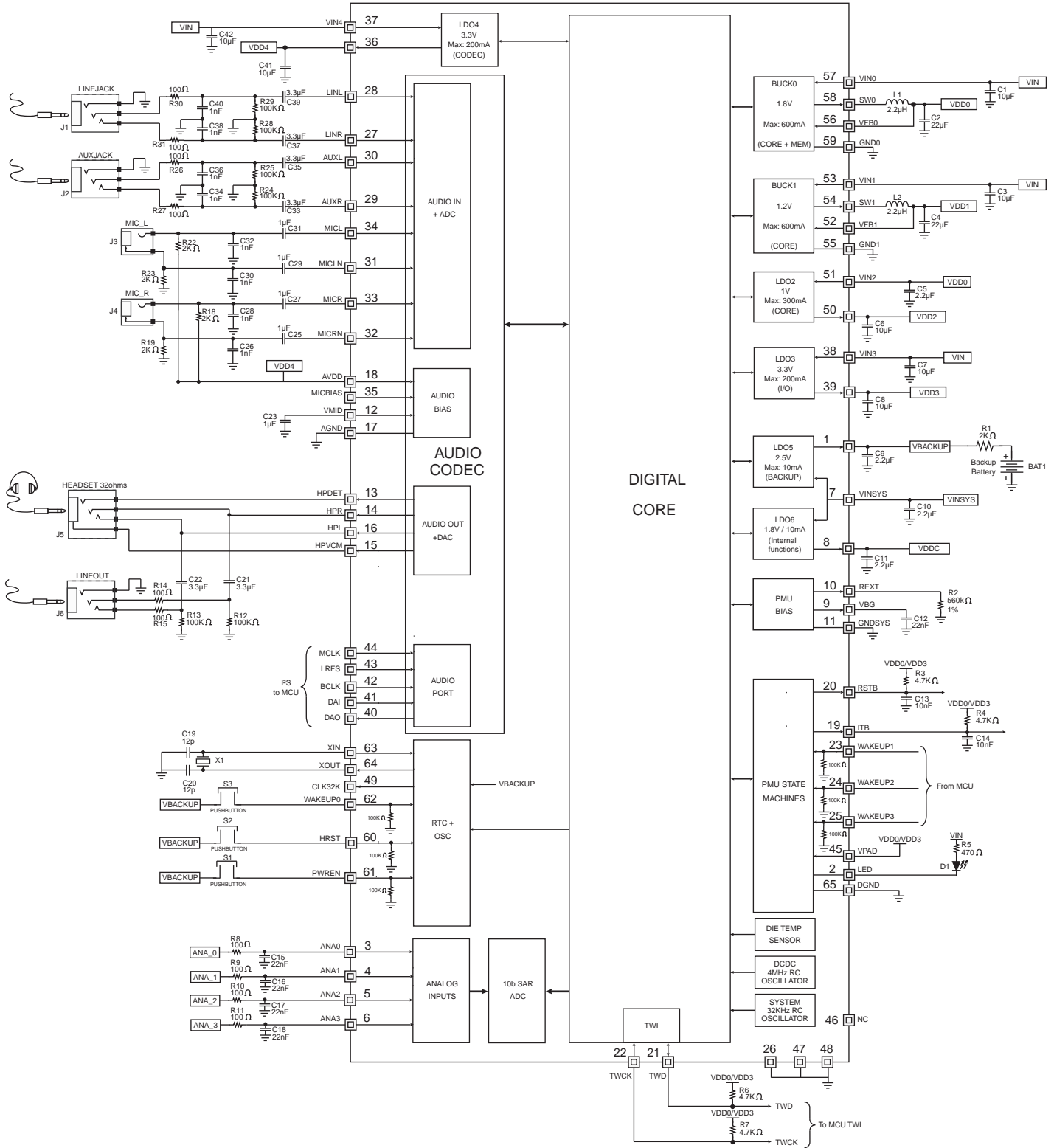

Table 5-1. Typical Application Components Design

Schematic Reference	Value	Description
R1, R18, R19, R22, R23	2k Ω	5% / 0.063W
R2	560k Ω	1% / 0.063W
R3, R4, R6,R7	4.7k Ω	5% / 0.063W
R5	470 Ω	5% / 0.063W
R8, R9, R10, R11, R14, R15, R26, R27, R30, R31	100 Ω	5% / 0.063W
R12, R13, R24, R25, R28, R29	100k Ω	5% / 0.063W
C1, C3, C6, C7, C8, C10, C41, C42	10 μ F	X5R / 6.3V TDK: C1608X5R0J106MT MURATA: GRM188R60J106ME47
C2, C4	22 μ F	X5R / 6.3V TDK: C2012X5R0J226M MURATA: GRM21BR60J226ME39
C5, C9, C11	2.2 μ F	X5R / 6.3V
C23, C25, C27, C29, C31	1 μ F	X5R / 6.3V
C13, C14	10nF	X5R / 6.3V
C15, C16, C17, C18, C12	22nF	X5R / 6.3V
C19, C20	12pF	C0G / 25V
C21, C22, C33, C35, C37, C39	3.3 μ F	X5R / 6.3V
C26, C28, C30, C32, C34, C36, C38, C40	1nF	X5R
L1, L2	2.2 μ H	COILCRAFT: LPS3314-222

6. Absolute Maximum Ratings

Table 6-1. Absolute Maximum Ratings

Operating Temperature (Industrial).....	-40 C to + 85-C ⁽¹⁾
Storage Temperature.....	-55°C to + 150°C
Power Supply Input on V _{INSYS} , V _{IN{0,1,3,4}} , V _{PAD} ..	-0.3V to + 5.5V
Power Supply Input on V _{IN2} , A _{VDD} ..	-0.3V to + 3.6V
Digital I/O Input Voltage.....	-0.3V to + 5.5V
All Other Pins.....	-0.3V to + 5.5V
ESD (all pins).....	2 KV HBM / 100V MM ⁽²⁾

*NOTICE: Stresses beyond those listed under “Absolute Maximum Ratings” may cause permanent damage to the device. This is a stress rating only and functional operation of the device at these or other conditions beyond those indicated in the operational sections of this specification is not implied. Exposure to absolute maximum rating conditions for extended periods may affect device reliability.

- Notes: 1. Refer to Power Dissipation Rating section
 2. According to specifications MIL-883-Method 3015.7 (HBM - Human Body Model) / JESD22 A115 (MM - Machine Model)

7. Recommended Operating Conditions

Table 7-1. Recommended Operating Conditions

Parameter	Condition	Min	Max	Units
Operating Ambient Temperature ⁽¹⁾		-40	85	°C
Power Supply Input	V _{INSYS}	2.5	5.5	V
Power Supply Input	V _{IN{0,1,3,4}}	2.9	5.5	V
Power Supply Input	V _{IN2}	1.65	3.6	V
Power Supply Input	A _{VDD}	2.7	3.6	V
Power Supply Input	V _{PAD}	1.75	5.5	V

- Note: 1. Refer to Power Dissipation Rating section

8. Power Dissipation Ratings

Table 8-1. Recommended Operating Conditions

Parameter	Condition	Min	Typ	Max	Units
Junction Temperature (Tj)		-40		125	°C
R _{THJA} ⁽¹⁾	Package thermal junction to ambient resistance		30	35	°C / W
Maximum On-chip Power Dissipation	Ambient temperature = 70°C		1.8	1.6	W
	Ambient temperature = 85°C		1.3	1.1	W

- Note: 1. According to specification JESD51-5

9. PMU Electrical Characteristics

9.1 Current Consumption Versus Modes

Table 9-1. Current Consumption Versus Modes

Symbol	Parameter	Comments	Min	Typ	Max	Units
V_{IN}	Operating Supply Voltage	V_{INSYS} , $V_{IN\{0,1,3,4\}}$ present.	2.9	3.6	5.5	V
I_{DD_VIN}	POWERDOWN Mode.	All LDOs and DCDC converters OFF. Audio OFF. RTC running.	-	20	40	μ A
	RUN Mode.	All LDOs and DCDC converters running in PWM. Audio OFF. RTC running.	-	7	15	mA
	STANDBY Mode.	Default setup: DCDC0 ON in low-power mode. LDO3 ON. All other functions OFF.	-	310	500	μ A
I_{DD_RTC}	All Modes.	RTC running. Total current entering pin V_{BACKUP}		1	5	μ A

9.2 Supply Monitor Thresholds

The following table applies to functional state diagrams of [Figure 11-1 “AT73C246 Power Manager Functional State Diagram”](#) on page 25 and [Figure 11-2 “AT73C246 Start-up and Shutdown State Diagram”](#) on page 26.

Table 9-2. Supply Monitor Thresholds

Symbol	Parameter	Comments	Min	Typ	Max	Units
$V_{IN} > 3.1V$	PMU Input 3.1V Rising Threshold		3.070	3.1	3.130	V
$V_{IN} < 2.9V$	PMU Input 2.9V Falling Threshold		2.870	2.9	2.930	V
$V_{IN} > 2.7V$	PMU Input 2.7V Rising Threshold		2.70	2.75	2.85	V
$V_{IN} < 2.7V$	PMU Input 2.7V Falling Threshold		2.60	2.65	2.70	V
$V_{BKP} > 1.8V$	V_{BACKUP} Input Rising Threshold		1.80	1.85	1.90	V
$V_{BKP} < 1.8V$	V_{BACKUP} Input Falling Threshold		1.70	1.75	1.80	V

9.3 Digital I/Os DC Characteristics

Table 9-3. V_{PAD} Referred Digital I/Os

Symbol	Parameter	Comments	Min	Typ	Max	Units
V_{PAD}	Operating Supply Voltage		1.75	3.6	5.5	V
V_{IL}	Input Low-Level Voltage		-0.3	-	$0.3 \times V_{PAD}$	V
V_{IH}	Input High-Level Voltage		$0.7 \times V_{PAD}$	-	$V_{PAD} + 0.3$	V
V_{OH}	Output High-Level Voltage	I_O max.	$0.75 \times V_{PAD}$	-	-	V
V_{OL}	Output Low-Level Voltage	I_O max	-	-	$0.25 \times V_{PAD}$	V
I_O	Output Current		-	-	8	mA
R_P	Pull-Up or Pull-Down Resistance	When applicable.	70	100	145	k Ω

- Notes:
1. V_{PAD} referred pins ITB, RSTB: open drain outputs. Only V_{OL} and I_O parameters are applicable.
 2. V_{PAD} referred pins WAKEUP1, WAKEUP2, WAKEUP3, MCLK, DAI, TWCK: CMOS inputs. Only V_{IH} and V_{IL} parameters are applicable.
 3. V_{PAD} referred pins MCLK32K, DAO: CMOS outputs. Only V_{OL} , V_{OH} and I_O parameters are applicable.
 4. V_{PAD} referred pin TWD: CMOS input and open drain output. Only V_{IL} , V_{IH} , V_{OL} , I_O parameters are applicable.
 5. V_{PAD} referred pins LRFS, BCLK: CMOS BiDir. All parameters applicable

Table 9-4. V_{BACKUP} Referred Digital I/Os

Symbol	Parameter	Comments	Min	Typ	Max	Units
V_{BACKUP}	Operating Supply Voltage		1.75	2.5	2.65	V
V_{IL}	Input Low-Level Voltage		-0.3	-	$0.3 \times V_{BACKUP}$	V
V_{IH}	Input High-Level Voltage		$0.7 \times V_{BACKUP}$	-	$V_{BACKUP} + 0.3$	V
V_{OH}	Output High-Level Voltage	I_O max.	$0.75 \times V_{BACKUP}$	-	-	V
V_{OL}	Output Low-Level Voltage	I_O max	-	-	$0.25 \times V_{BACKUP}$	V
I_O	Output Current		-	-	8	mA
R_P	Pull-Up or Pull-Down resistance	When applicable.	70	100	145	k Ω

- Note: V_{BACKUP} referred pins PWREN, HRST, WAKEUP0: CMOS inputs. Only V_{IL} and V_{IH} parameters are applicable.

9.4 DCDC0 and DCDC1

Unless otherwise specified: External components $L=2.2\mu\text{H}$, $C_{\text{OUT}}=22\mu\text{F}$ and $C_{\text{IN}}=10\mu\text{F}$. $V_{\text{IN}(0,1)} > V_{\text{DD}(0,1)} + 500\text{mV}$.
 $T_j = [-40^\circ\text{C} ; +125^\circ\text{C}]$.

Table 9-5. DCDC0 and DCDC1 Electrical Characteristics

Symbol	Parameter	Comments	Min	Typ	Max	Units
V_{IN}	Operating Supply Voltage	$V_{\text{IN}0}$, $V_{\text{IN}1}$ and V_{INSYS}	2.9	3.6	5.5	V
I_{DD}	Supply Current ⁽¹⁾	OFF	-	-	1	μA
		PFM operation. $V_{\text{DD}0} = 1.85\text{V}$, $V_{\text{DD}1} = 1.2\text{V}$	-	40	80	μA
		PWM operation. $V_{\text{DD}0} = 1.85\text{V}$, $V_{\text{DD}1} = 1.2\text{V}$	-	3	6.5	mA
I_{O}	Output Current	PFM operation.	-	-	50	mA
		PWM operation.	-	-	600	mA
f_{SW}	Switching Frequency	PWM operation.	1.8	2	2.2	MHz
$V_{\text{DD}0}$	Default Output Voltage ⁽²⁾	$V_{\text{DD}0}$	-	1.85	-	V
$V_{\text{DD}1}$		$V_{\text{DD}1}$	-	1.2	-	V
$V_{\text{DD_RANGE}}$	Programmable Output Voltage Range	PFM or PWM operation.	0.8		3.6	V
$V_{\text{DD_STEP}}$	Output Voltage Steps	PFM or PWM operation.		50		mV
N_{STEP}	Number of Output Steps	In case of direct output voltage programming. Automatic ramping not active.			4	step / 100 μs
T_{STEP}	Step time	With automatic ramping.	260	280	300	μs
$V_{\text{DD_ACC}}$	DC Output Voltage Accuracy	PFM; $T_j = 25^\circ\text{C}$; $I_{\text{O}} = 0\text{ mA}$	-1.5		2.5	%
		PFM; $T_j = [-40; 125^\circ\text{C}]$; $I_{\text{O}} = 0\text{ mA}$	-2		3	
		PWM; $T_j = 25^\circ\text{C}$; $I_{\text{O}} = 0\text{ mA}$	-1.5		1.5	
		PWM; $T_j = [-40; 125^\circ\text{C}]$; $I_{\text{O}} = 0\text{ mA}$	-2		2	
$V_{\text{DD_RIPPLE}}$	Ripple Voltage	PWM operation.		2		mV
$\Delta V_{\text{DD_IL}}$	Static Load Regulation	PWM operation. I_{O} ranging from 0 to I_{OMAX}		2	5	mV
	Dynamic Load Regulation	PWM. I_{O} : 0 to I_{OMAX} ; 1 μs rise time		-40		
		PWM. I_{O} : I_{OMAX} to 0; 1 μs fall time		40		
$\Delta V_{\text{DD_VIN}}$	Static Line Regulation	$V_{\text{IN}0}$ and V_{INSYS} from 2.9 to 5.5V $V_{\text{DD}0} = 1.85\text{V}$, $V_{\text{DD}1} = 1.2\text{V}$			5	mV
Eff	Efficiency	PWM. I_{OMAX} load. $V_{\text{DD}0} = 1.85\text{V}$. Relative to $V_{\text{IN}0}$ input supply.		85		%
		PWM. I_{OMAX} load. $V_{\text{DD}1} = 1.2\text{V}$. Relative to $V_{\text{IN}1}$ input supply.		78		%
I_{INRUSH}	Inrush Current ⁽¹⁾	Current from $V_{\text{IN}(0,1)}$ and V_{INSYS} from 0 to 100% $V_{\text{DD}(0,1)}$ $V_{\text{DD}0} = 1.85\text{V}$, $V_{\text{DD}1} = 1.2\text{V}$		30	200	mA

Table 9-5. DCDC0 and DCDC1 Electrical Characteristics

Symbol	Parameter	Comments	Min	Typ	Max	Units
OCP	Over-Current Protection	Output current.	1	1.4	1.8	A
T _{START}	Start-up Time	From OFF to PWM operation. V _{DD(0,1)} rising to 95% of final value.			5	ms
T _{PWM}	PFM to PWM Settling Time	No output load.		10		μs
PWRF _{DET}	Power Fail Detector Threshold Accuracy	Overload of the programmed threshold by 10mV / 5us min ⁽³⁾ .	-1	-	+1	%·V _{DD}
C _{OUT}	Total Capacitive Load	At V _{FB(0,1)} pins.	8		36	μF

- Notes:
1. Current consumption without load. One DCDC converter ON, the other one OFF.
 2. Default output voltage are set during manufacturing. Please contact Atmel for other default settings.
 3. Threshold levels are programmed in register PMU_RST_LVL (0x04)

9.5 LDO2

Unless otherwise specified: External components $C_{OUT}=10\mu\text{F}$, $C_{IN}=10\mu\text{F}$, $T_J = [-40^\circ\text{C} ; +125^\circ\text{C}]$.

Table 9-6. LDO2 Electrical Characteristics

Symbol	Parameter	Comments	Min	Typ	Max	Units
V_{IN}	Operating Supply Voltage	V_{IN2}	1.65	1.8	3.6	V
I_{DD}	Supply Current ⁽¹⁾	OFF	-	-	1	μA
		ON	-	-	250	μA
I_O	Output Current	$V_{IN2} > V_{DD2} + 500\text{mV}$.	-	-	300	mA
V_{DD2}	Default Output Voltage ⁽²⁾		-	1	-	V
V_{DD_RANGE}	Programmable Output Voltage Range		0.8		1.35	V
V_{DD_STEP}	Output Voltage Steps			50		mV
T_{STEP}	Step time	With automatic ramping.	570	600	630	μs
V_{DD_ACC}	DC Output Voltage Accuracy	$V_{IN2} > V_{DD2} + 500\text{mV}$ $T_J = 25^\circ\text{C}$; $I_O = 0\text{ mA}$	-1		1	%
		$V_{IN2} > V_{DD2} + 500\text{mV}$ $T_J = [-40^\circ\text{C} ; 125^\circ\text{C}]$; $I_O = 0\text{ mA}$	-1.5		1.5	
ΔV_{DD_IL}	Static Load Regulation	$V_{IN2} > V_{DD2} + 500\text{mV}$ I_O ranging from 0 to I_{OMAX}		0.05	1	$\% \cdot V_{DD2}$
	Dynamic Load Regulation	$V_{IN2} > V_{DD2} + 500\text{mV}$ I_O : 0 to I_{OMAX} ; 1 μs rise time		-50		mV
		$V_{IN2} > V_{DD2} + 500\text{mV}$ I_O : I_{OMAX} to 0 ; 1 μs fall time		50		
ΔV_{DD_VIN}	Static Line Regulation	$I_O = 0\text{ mA}$ V_{IN2} from 1.65 to 3.6V			5	mV
$V_{DROPOUT}$	Drop Out Voltage ⁽⁴⁾	$I_O = 200\text{mA}$			300	mV
		$I_O = 300\text{mA}$			450	mV
I_{INRUSH}	Inrush Current	Current from V_{IN2} from 0 to 95% of final value.		200	500	mA
T_{START}	Start-up Time	V_{DD2} OFF and rising to 95% of final value. $I_O = 0\text{ mA}$			1	ms
$PWRF_{DET}$	Power Fail Detector Threshold Accuracy	Overload of the programmed threshold by 10mV / 5us min ⁽³⁾ .	-1	-	+1	$\% \cdot V_{DD2}$

- Notes:
1. Current consumption in V_{IN2} without load.
 2. Default output voltage are set during manufacturing. Please contact Atmel for other default settings.
 3. Threshold level is programmed in register PMU_RST_LVL (0x04)
 4. $V_{DROPOUT} = V_{IN2} - V_{DD2}$ when $V_{DD2} = 98\%$ of V_{DD2} obtained with $V_{IN2} > V_{DD2} + 500\text{mV}$

9.6 LDO3

Unless otherwise specified: External components $C_{OUT}=10\mu\text{F}$, $C_{IN}=10\mu\text{F}$, $T_J = [-40^\circ\text{C} ; +125^\circ\text{C}]$.

Table 9-7. LDO3 Electrical Characteristics

Symbol	Parameter	Comments	Min	Typ	Max	Units
V_{IN}	Operating Supply Voltage	V_{IN3}	2.9	3.6	5.5	V
I_{DD}	Supply Current ⁽¹⁾	OFF	-	-	1	μA
		ON	-	-	350	μA
I_O	Output Current	$V_{IN3} > V_{DD3} + 300\text{mV}$.	-	-	200	mA
V_{DD3}	Default Output Voltage ⁽²⁾		-	3.3	-	V
V_{DD_RANGE}	Programmable Output Voltage Range		2.7		3.6	V
V_{DD_STEP}	Output Voltage Steps			50		mV
T_{STEP}	Step time	With automatic ramping.	570	600	630	μs
V_{DD_ACC}	DC Output Voltage Accuracy	$V_{IN3} > V_{DD3} + 300\text{mV}$ $T_J = 25^\circ\text{C}$; $I_O = 0\text{ mA}$	-1		1	%
		$V_{IN3} > V_{DD3} + 300\text{mV}$ $T_J = [-40^\circ\text{C} ; 125^\circ\text{C}]$; $I_O = 0\text{ mA}$	-1.5		1.5	
ΔV_{DD_IL}	Static Load Regulation	$V_{IN3} > V_{DD3} + 300\text{mV}$ I_O ranging from 0 to I_{OMAX}		0.05	0.5	$\% \cdot V_{DD3}$
	Dynamic Load Regulation	$V_{IN3} > V_{DD3} + 300\text{mV}$ I_O : 0 to I_{OMAX} ; $1\mu\text{s}$ rise time		-40		mV
		$V_{IN3} > V_{DD3} + 300\text{mV}$ I_O : I_{OMAX} to 0 ; $1\mu\text{s}$ fall time		40		
ΔV_{DD_VIN}	Static Line Regulation	$V_{IN3} > V_{DD3} + 300\text{mV}$. $I_O = 0\text{ mA}$ V_{IN3} from 2.9 to 5.5V			5	mV
$V_{DROPOUT}$	Drop Out Voltage ⁽⁴⁾	$I_O = 10\text{mA}$			50	mV
		$I_O = 200\text{mA}$			250	mV
PSRR	Power Supply Rejection Ratio	$V_{IN3} > V_{DD3} + 300\text{mV}$ $I_O = 1\text{mA}$. DC to 3kHz.		60		dB
		$V_{IN3} > V_{DD3} + 300\text{mV}$ $I_O = 10\text{mA}$. DC to 3kHz.		50		
I_{INRUSH}	Inrush Current	Current from V_{IN3} from 0 to 95% of final value.		200	500	mA
T_{START}	Start-up Time	V_{DD3} OFF and rising to 95% of final value. $I_O = 0\text{ mA}$			1	ms
$PWRF_{DET}$	Power Fail Detector Threshold Accuracy	Overload of the programmed threshold by $10\text{mV} / 5\mu\text{s min}^{(3)}$.	-1	-	+1	$\% \cdot V_{DD3}$

Notes: 1. Current consumption in V_{IN3} without load.

2. Default output voltage are set during manufacturing. Please contact Atmel for other default settings.

3. Threshold level is programmed in register PMU_RST_LVL (0x04)

4. $V_{DROPOUT} = V_{IN3} - V_{DD3}$ when $V_{DD3} = 98\%$ of V_{DD3} obtained with $V_{IN3} > V_{DD3} + 300\text{mV}$

9.7 LDO4

Unless otherwise specified: External components $C_{OUT}=10\mu F$, $C_{IN}=10\mu F$, $T_J = [-40^\circ C ; +125^\circ C]$.

Table 9-8. LDO4 Electrical Characteristics

Symbol	Parameter	Comments	Min	Typ	Max	Units
V_{IN}	Operating Supply Voltage	V_{IN4}	2.9	3.6	5.5	V
I_{DD}	Supply Current ⁽¹⁾	OFF	-	-	1	μA
		ON	-	-	350	μA
I_O	Output Current	$V_{IN4} > V_{DD4} + 300mV$.	-	-	200	mA
V_{DD4}	Default Output Voltage ⁽²⁾		-	3.3	-	V
V_{DD_RANGE}	Programmable Output Voltage Range		2.7		3.6	V
V_{DD_STEP}	Output Voltage Steps			50		mV
T_{STEP}	Step time	With automatic ramping.	570	600	630	μs
V_{DD_ACC}	DC Output Voltage Accuracy	$V_{IN4} > V_{DD4} + 300mV$ $T_J = 25^\circ C ; I_O = 0 mA$	-1		1	%
		$V_{IN4} > V_{DD4} + 300mV$ $T_J = [-40^\circ C ; 125^\circ C] ; I_O = 0 mA$	-1.5		1.5	
ΔV_{DD_IL}	Static Load Regulation	$V_{IN4} > V_{DD4} + 300mV$ I_O ranging from 0 to I_{OMAX}		0.05	0.5	$\% \cdot V_{DD4}$
	Dynamic Load Regulation	$V_{IN4} > V_{DD4} + 300mV$ I_O : 0 to I_{OMAX} ; 1 μs rise time		-40		mV
		$V_{IN4} > V_{DD4} + 300mV$ I_O : I_{OMAX} to 0 ; 1 μs fall time		40		
ΔV_{DD_VIN}	Static Line Regulation	$V_{IN4} > V_{DD4} + 300mV$. $I_O = 0 mA$ V_{IN4} from 2.9 to 5.5V			5	mV
$V_{DROPOUT}$	Drop Out Voltage ⁽³⁾	$I_O = 10mA$			50	mV
		$I_O = 200mA$			250	mV
PSRR	Power Supply Rejection Ratio	$V_{IN4} > V_{DD4} + 300mV$ $I_O = 1mA$. DC to 3kHz.		60		dB
		$V_{IN4} > V_{DD4} + 300mV$ $I_O = 10mA$. DC to 3kHz.		50		
I_{INRUSH}	Inrush Current	Current from V_{IN4} from 0 to 95% of final value.		200	500	mA
T_{START}	Start-up Time	V_{DD4} OFF and rising to 95% of final value. $I_O = 0 mA$			1	ms

- Notes:
1. Current consumption in V_{IN4} without load.
 2. Default output voltage are set during manufacturing. Please contact Atmel for other default settings.
 3. $V_{DROPOUT} = V_{IN4} - V_{DD4}$ when $V_{DD4} = 98\%$ of V_{DD4} obtained with $V_{IN4} > V_{DD4} + 300mV$

9.8 LDO5

Unless otherwise specified: External components $C_{OUT}=2.2\mu\text{F}$, $C_{IN}=10\mu\text{F}$, $T_J = [-40^\circ\text{C} ; +125^\circ\text{C}]$.

Table 9-9. LDO5 Electrical Characteristics

Symbol	Parameter	Comments	Min	Typ	Max	Units
V_{IN}	Operating Supply Voltage	V_{INSYS}	2.7	3.6	5.5	V
I_{DD}	Supply Current ⁽¹⁾	OFF	-	-	1	μA
		ON	-	-	7	μA
I_O	Output Current		-	-	10	mA
V_{BACKUP}	Output Voltage Accuracy		2.42	2.5	2.58	V
Δ_{VDD_VIN}	Static Line Regulation	V_{INSYS} from 2.7 to 5.5V		3	10	mV
Δ_{VDD_VIN}	Static Line Regulation	$V_{INSYS} = 3.6\text{V}$, I_O from 0 to I_{OMAX}		10	15	mV
I_{INRUSH}	Inrush Current	Current from V_{INSYS} from 0 to $T_{START(MAX)}$; $V_{BACKUP} = 2.5\text{V}$		180	350	mA
T_{START}	Start-up Time	V_{BACKUP} OFF and rising to 95% of final value.			1	ms

Note: 1. Current consumption in V_{INSYS} without plugged backup battery

9.9 Measurement Bridge and 10-bit ADC

Table 9-10. Measurement Bridge and 10-bit ADC Electrical Characteristics

Symbol	Parameter	Comments	Min	Typ	Max	Units
V_{IN}	Operating Supply Voltage ⁽¹⁾	V_{INSYS}	2.9	3.6	5.5	V
I_{DD}	Supply Current	OFF	-	-	1	μ A
		ON	-	-	2	mA
V_{REF}	Reference Voltage	Internally connected to VDDC pin.	1.75	1.8	1.85	V
INL	Integral Non Linearity	End Point Method	-2	-	+2	LSB
DNL	Differential Non Linearity	End Point Method	-1	-	+1	LSB
Offset	Offset Error		-2		+2	LSB
GAIN	Gain Error		-2		+2	LSB
F_S	Sampling Rate			300		kS/s
T_{ACQ}	Track and Hold Acquisition Time		500			ns
V_{MEAS}	Measured Input Voltage Range	External inputs ANA{0,1,2,3}	0.4		V_{INSYS}	V
		$V_{DD\{0,1,2,3,4\}}$ inputs	0.4		4	V
		V_{INSYS} input	0.4		5.5	V
ATT_{MEAS}	Measured Input Scaling Factor	External inputs ANA{0,1,2,3}	-1%	0.25	+1%	V/V
		$V_{DD\{0,1,2,3,4,5\}}$ inputs	-1%	0.4	+1%	V/V
		V_{INSYS} input	-1%	0.25	+1%	V/V
R_{IN_NOM}	ANA{0,1,2,3} Input resistance	$T_j = 25C$	96	120	144	k Ω
R_{IN_TEMP}	R_{IN} deviation with temperature	T_j [-40 ; +25]. Relative to R_{IN_NOM}			+ 20	%
		T_j [25 ; 125]. Relative to R_{IN_NOM}	-16			
C_{IN}	ANA{0,1,2,3} Input capacitance				15	pF

- Notes: 1. The 10-bit ADC is supplied from the regulated V_{DDC} voltage (1.8V) which is generated from V_{INSYS} .
 2. Please refer to Atmel Data Converter Terminology literature

9.10 RTC Crystal Oscillator

Table 9-11. RTC Crystal Oscillator Electrical Characteristics

Symbol	Parameter	Comments	Min	Typ	Max	Units
V_{IN}	Operating Supply Voltage	V_{BACKUP}	1.75	2.5	2.65	V
Freq	Frequency	with crystal	-	32.768	-	kHz
Duty	Duty Cycle		40	50	60	%
I_{DD}	Supply Current ⁽¹⁾	OFF	-	-	5	nA
		ON	-	-	1.5	μ A
T_{ON}	Startup Time	$C_L = 12pF$	-	1000	1500	ms
V_{XIN}	Level Sinus Wave on XIN			250	300	mVpp
V_{XOUT}	Vpp On XOUT			300		mVpp
R_F	Internal Resistor	between xin and xout		10		M Ω
Drift	Accuracy	@25°C, +/- 20ppm			1.5	mn/month
Esr	Equivalent Series Resistance Rs	Crystal @ 32.768kHz		50	100	k Ω
C_M	Motional Capacitance	Crystal @ 32.768kHz	0.6		3	fF
C_{SHUNT}	Shunt Capacitance	Crystal @ 32.768kHz	0.6		2	pF
C_{LOAD}	Load Capacitance	Crystal @ 32.768kHz	6		12.5	pF

Note: 1. Current consumption in V_{BACKUP} with crystal. In case of crystal not present on-board, back-up batteries or supercapacitors, must be avoided.

9.11 Die Temperature Sensor

Table 9-12. Die Temperature Sensor Electrical Characteristics

Symbol	Parameter	Comments	Min	Typ	Max	Units
$T_{SHUTDOWN}$	130°C Shutdown Threshold		135	145	155	°C
$T_{RESTART}$	110°C Restart Threshold		105	115	125	°C

10. Audio Codec Electrical Characteristics

Unless otherwise specified: AVDD = 3.3V, T_A = 25C, MCLK = 12.288MHz, F_S = 48kHz. Master mode and 24-bit operation on I²S port. All gains set to 0dB, audio effects are off. Noise measurements are made in the [20Hz-20kHz] band using the A-Weighting filter. Distortion measurements are made from the 2nd to the 5th harmonic products of a 997Hz input sinewave. Input sources have an internal impedance of 50 Ohms. Audio Path without mixing capability.

Table 10-1. Audio Codec Bias

Symbol	Parameter	Comments	Min	Typ	Max	Units
AVDD	Operating Supply Voltage		2.7	3.3	3.6	V
I _{DD}	Supply Current	OFF			20	μA
		STANDBY			1	mA
V _{MID}	Mid-Supply Reference Voltage		-1%	AVDD / 2	+1%	V
T _{MID_ON}	Time to charge V _{MID} capacitor	From 0 to 95% of final value			350	ms/μF
T _{MID_OFF}	Time to discharge V _{MID} capacitor	From 0 to 95% of final value			700	ms/μF
V _{MICBIAS}	Microphone Bias Reference Voltage	No load.		AVDD		V
R _{MICBIAS}	Microphone Bias Reference Voltage Internal Resistance		1.5	1.9	2.3	kΩ

Table 10-2. Line Record Path: Line or Auxiliary Input to ADC Output

Symbol	Parameter	Comments	Min	Typ	Max	Units
V _{FS}	Full Scale Input Voltage ⁽¹⁾	Corresponds to 0dBFS digital output signal.		AVDD / 3.3		V _{RMS}
SNR	Signal-to-Noise Ratio ⁽²⁾	AVDD = 3.3V	85	96	-	dB
		AVDD = 2.7V	82	93	-	dB
DR	Dynamic Range ⁽³⁾	AVDD = 3.3V	85	96	-	dB
		AVDD = 2.7V	82	93	-	dB
THD	Total Harmonic Distortion	-1dBFS digital output	-	-80	-74	dB
XTALK	Left / Right Channel separation ⁽⁵⁾		80	90	-	dB
G _{LINE}	Programmable Gain Range		-34	0	12	dB
	Gain Step Size		-	1	-	dB
	Mute Attenuation ⁽⁶⁾		80	-	-	dB
R _{IN}	Input Resistance		5.9	7	8.1	kΩ
C _{IN}	Input Capacitance		-	-	10	pF

Table 10-3. Microphone Record Path: Microphone Input to ADC Output

Symbol	Parameter	Comments	Min	Typ	Max	Units
V _{FS}	Full Scale Input Voltage ⁽¹⁾	Corresponds to 0dBFS digital output signal.		AVDD / 3.3		V _{RMS}
SNR	Signal-to-Noise Ratio ⁽²⁾	AVDD = 3.3V	85	96	-	dB
		AVDD = 2.7V	82	93	-	dB

Table 10-3. Microphone Record Path: Microphone Input to ADC Output

Symbol	Parameter	Comments	Min	Typ	Max	Units
DR	Dynamic Range ⁽³⁾	AVDD = 3.3V	85	96	-	dB
		AVDD = 2.7V	82	93	-	dB
THD	Total Harmonic Distortion	-1dBFS digital output	-	-84	-74	dB
XTALK	Left / Right Channel separation ⁽⁵⁾		80	90	-	dB
G _{LINE}	Programmable Gain Range		0	-	46	dB
	Gain Step Size		-	1	-	dB
	Mute Attenuation ⁽⁶⁾		80	-	-	dB
R _{IN}	Input Resistance	0dB gain	8.4	12	15.6	kΩ
C _{IN}	Input Capacitance		-	-	10	pF

Table 10-4. Playback Path: DAC Input to Headphone Output

Symbol	Parameter	Comments	Min	Typ	Max	Units
V _{FS}	Full Scale Output Voltage ⁽¹⁾	0dBFS digital input signal.		AVDD / 3.3		V _{RMS}
SNR	Signal-to-Noise Ratio ⁽²⁾	AVDD = 3.3V	92	97	-	dB
		AVDD = 2.7V	89	94	-	dB
DR	Dynamic Range ⁽³⁾	AVDD = 3.3V	92	97	-	dB
		AVDD = 2.7V	89	94	-	dB
THD	Total Harmonic Distortion	0dBFS input - 10kΩ load	-	-88	-80	dB
		20mW output - 32Ω load	-	-65	-60	dB
		20mW output - 16Ω load	-	-60	-55	dB
P _O	Output Power	32Ω load - THD < -40dB or 1%		30		mW
		16Ω load - THD < -40dB or 1%		50		mW
XTALK	Left / Right Channel Separation ⁽⁵⁾	10kΩ AC coupled load		90		dB
		16Ω DC coupled load		60		dB
G _{HS}	Programmable Gain Range		-77	-	+6	dB
	Gain Step Size		-	1	-	dB
	Mute Attenuation ⁽⁶⁾		80	-	-	dB

Table 10-5. Analog Bypass Path: Line / Auxiliary Input to Headphone Output

Symbol	Parameter	Comments	Min	Typ	Max	Units
V _{FS}	Full Scale Output Voltage ⁽¹⁾			AVDD / 3.3		V _{RMS}
SNR	Signal-to-Noise Ratio ⁽²⁾	AVDD = 3.3V	92	97	-	dB
		AVDD = 2.7V	89	94	-	dB
DR	Dynamic Range ⁽³⁾	AVDD = 3.3V	92	97	-	dB
		AVDD = 2.7V	89	94	-	dB

Table 10-5. Analog Bypass Path: Line / Auxiliary Input to Headphone Output

Symbol	Parameter	Comments	Min	Typ	Max	Units
THD	Total Harmonic Distortion	0dBFS input - 10k Ω load	-	-88	-80	dB
		20mW output - 32 Ω load	-	-65	-60	dB
		20mW output - 16 Ω load	-	-60	-55	dB
P _O	Output Power	32 Ω load - THD < -40dB or 1%		30		mW
		16 Ω load - THD < -40dB or 1%		50		mW
XTALK	Left / Right Channel Separation ⁽⁵⁾	10k Ω AC coupled load		90		dB
		16 Ω DC coupled load		60		dB
G _{BYP}	Bypass Gain		-1	0	+1	dB
	Mute Attenuation ⁽⁶⁾		80	-	-	dB

Table 10-6. Analog Sidetone Path: Microphone Input to Headphone Output

Symbol	Parameter	Comments	Min	Typ	Max	Units
V _{FS}	Full Scale Output Voltage ⁽¹⁾			AVDD / 3.3		V _{RMS}
SNR	Signal-to-Noise Ratio ⁽²⁾	AVDD = 3.3V	92	97	-	dB
		AVDD = 2.7V	89	94	-	dB
DR	Dynamic Range ⁽³⁾	AVDD = 3.3V	92	97	-	dB
		AVDD = 2.7V	89	94	-	dB
THD	Total Harmonic Distortion	0dBFS input - 10k Ω load	-	-88	-80	dB
		20mW output - 32 Ω load	-	-65	-60	dB
		20mW output - 16 Ω load	-	-60	-55	dB
P _O	Output Power	32 Ω load - THD < -40dB or 1%		30		mW
		16 Ω load - THD < -40dB or 1%		50		mW
XTALK	Left / Right Channel Separation ⁽⁵⁾	10k Ω AC coupled load		90		dB
		16 Ω DC coupled load		60		dB
G _{SIDETONE}	Programmable Gain Range		-30	-	0	dB
	Gain Steps		2.5	3	3.5	dB
	Mute Attenuation ⁽⁶⁾		80	-	-	dB

- Notes:
1. Full Scale: A linear extrapolation to 0dBFS of the measured level at -10dBFS.
 2. Signal-to-Noise Ratio: The ratio of the RMS value of a 997Hz full scale sine wave to the RMS value of output noise with no signal applied. Device is not muted.
 3. Dynamic Range: According to AES17-1991 (Audio Engineering Society) and EIAJ CP-307 (Electronic Industries Association of Japan), an extrapolation to 0dBFS input signal of the THD+N ratio measurement at -60dBFS. As an example, if THD+N @ -60dBFS = -36dB, then DR = 96dB.
 4. Total Harmonic Distortion + Noise Ratio: The ratio of the RMS sum of the noise and the distortion components to the RMS value of the signal.
 5. XTALK: Attenuation measurement from one channel to the other one. Measurement is performed by stimulated one channel with a 997Hz / -10dBFS sinewave and leaving the other channel unstimulated.
 6. Mute Attenuation: Attenuation measurement of a -10dBFS / 997Hz input signal when concerned gain is set to mute.

11. PMU Functional Description

11.1 Power Manager State Diagram

Figure 11-1. AT73C246 Power Manager Functional State Diagram

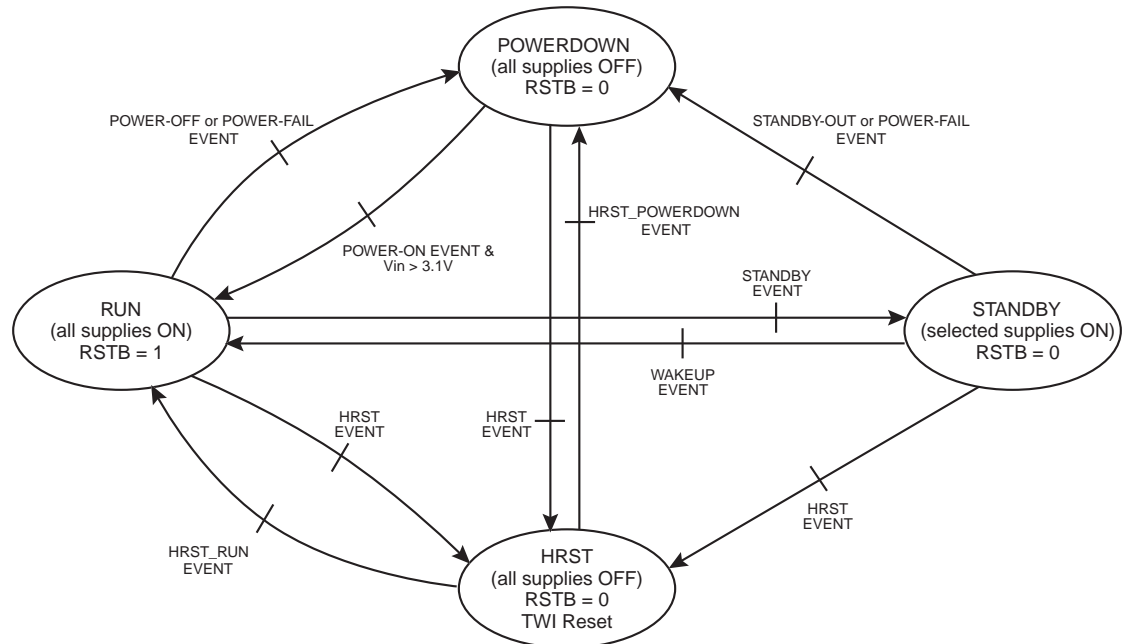

AT73C246 is placed in POWERDOWN state at VINSYS rising following the PMU startup state diagram described in [Figure 11-2 on page 26](#). From this POWERDOWN state, normal CPU supplies startup is achieved through validation of one of the POWER-ON events. From this state, the PMU may be placed in STANDBY state (e.g.: during CPU sleep periods) upon software request (STANDBY event). PMU wake-up is achieved if one of the WAKEUP events is detected. The PMU returns to the POWERDOWN state as soon as a POWER-OFF event is detected. A special HRST (Hard-Reset) state is provided to ensure complete stop and restart of the CPU supplies in case of a software crash. Moreover, die temperature and $VDD_{\{0,1,2,3\}}$ supplies are supervised and may generate a POWER-FAIL event in case of out-of-specification detection.

11.2 PMU Startup and Shutdown State Diagram

Figure 11-2. AT73C246 Start-up and Shutdown State Diagram

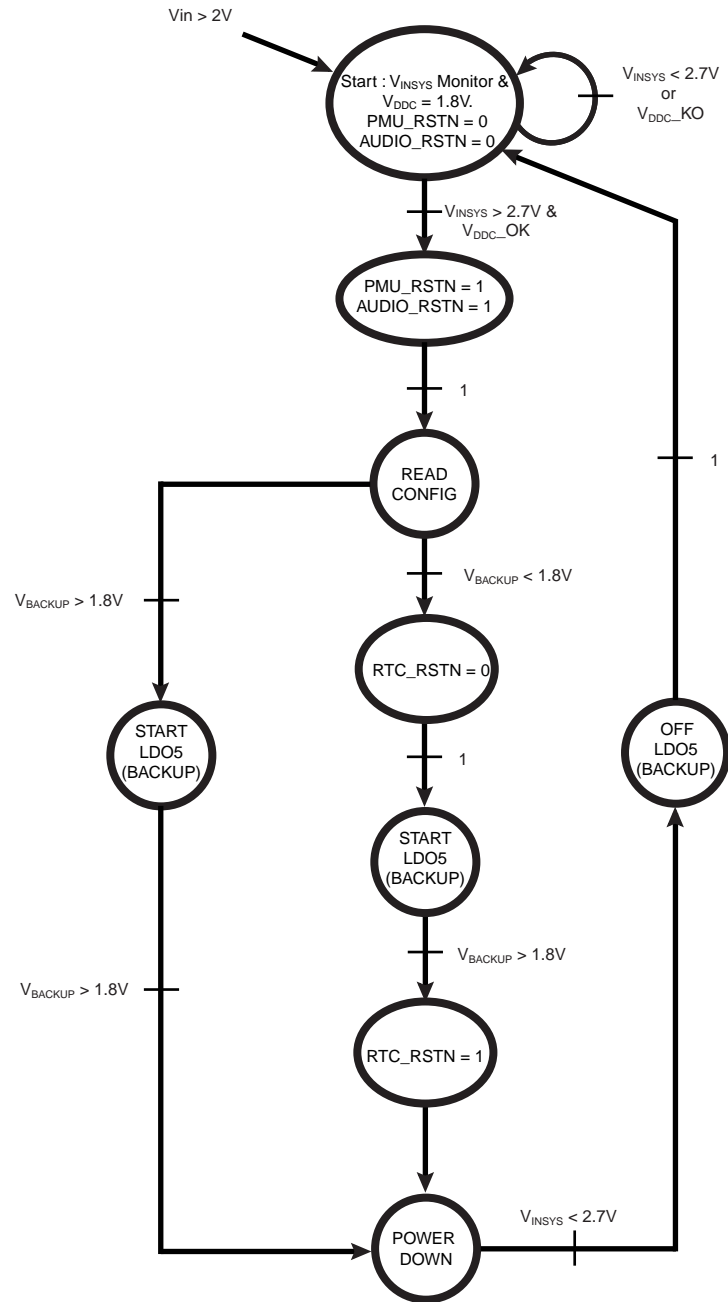

The start-up of the AT73C246 follows the flow diagram of [Figure 11-2](#) and aims at placing the power manager in the POWERDOWN state.

When V_{INSYS} rises above 2V:

- An internal V_{INSYS} monitor starts and holds the internal PMU_RSTN and AUDIO_RSTN signals to 0, thus forcing a complete reset of AT73C246. The PMU digital core supply voltage

($V_{DDC} = 1.8V$) is started. During this PMU reset, the 'LED' pin is driven to VINSYS (LED is OFF).

- When V_{DDC} is ready and $V_{INSYS} > 2.7V$, the internal reset signals previously mentioned are released, thus enabling the PMU digital core functions.
- Before starting the LDO5 (RTC supply), V_{BACKUP} voltage is monitored and if it is lower than 1.8V, the RTC function is resetted. In case of $V_{BACKUP} > 1.8V$, no reset is issued on the RTC function.
- At this step, the power manager is placed in POWERDOWN state.

11.3 Power Manager Conditional Transitions

11.3.1 POWER-ON EVENTS

POWER-ON EVENTS are validated if all these listed conditions are true:

- $V_{INSYS} > 3.1V$
- AT73C246 internal junction temperature $T_j < 110^\circ C$
- PWREN pin is high for more than 100ms (see [Table 11-1 on page 28](#)).

Note: PWREN pin, with internal 100k pull-down resistor, is active high (V_{BACKUP} level). It is possible to hard wire the PWREN pin to V_{BACKUP} to always activate RUN state when $V_{INSYS} > 3.1V$. Consequently, using the software POWER-OFF EVENT (described in [Section 11.3.2](#)) will lead to going back to the RUN state just after the POWERDOWN STATE.

11.3.2 POWER-OFF EVENTS

POWER-OFF EVENTS are validated if one of these listed conditions is true:

- $V_{INSYS} < 2.9V$.
- PWREN pin goes from low to high state and high state is held for more than 5s (see [Table 11-1 on page 28](#)).
- Software request: bit 0 (OFF) of register 0x00 (PMU_MODES) is written to 1.

11.3.3 POWER-FAIL EVENTS

POWER-FAIL EVENTS are validated if one of these listed conditions is true:

- AT73C246 internal junction temperature $T_j > 130^\circ C$
- Any internal power fail detection signal coming from any CPU power supply (V_{DD0} , V_{DD1} , V_{DD2} , V_{DD3}) goes from low to high level.

Note: In case of PWREN pin hard wired high (V_{BACKUP} level), the POWER-FAIL EVENTS will lead to the POWERDOWN state without possibility to go to the RUN state. The power manager will be able to reach the RUN state only after an HRST event. This prevents the power manager from oscillating between RUN and POWERDOWN states in case of permanent failure on CPU supplies.

11.3.4 STANDBY EVENT

STANDBY EVENT is validated if the following condition is true:

- Software request: bit 1 (STANDBY) of register 0x00 (PMU_MODES) is written to 1.

11.3.5 STANDBY-OUT EVENT

STANDBY-OUT EVENT is validated if the following condition is true:

- $V_{INSYS} < 2.9V$.

11.3.6 WAKEUP EVENTS

WAKEUP EVENTS are validated if one of the listed condition is true:

- WAKEUP0 pin goes from low to high state and WAKEUP0 bit is set to '1' (see [Table 11-1](#)) in register 0x01 (PMU_WAKEUP_EVENTS).
- WAKEUP1 pin goes from low to high state and WAKEUP1 bit is set to '1' (see [Table 11-1](#)) in register 0x01 (PMU_WAKEUP_EVENTS).
- WAKEUP2 pin goes from low to high state and WAKEUP2 bit is set to '1' (see [Table 11-1](#)) in register 0x01 (PMU_WAKEUP_EVENTS).
- WAKEUP3 pin goes from low to high state and WAKEUP3 bit is set to '1' (see [Table 11-1](#)) in register 0x01 (PMU_WAKEUP_EVENTS).
- PWREN pin goes from low to high state and high state is held for more than 10ms (see [Table 11-1](#)) and PWREN bit is set to '1' in register 0x01 (PMU_WAKEUP_EVENTS).
- An RTC alarm occurs and RTC bit is set to '1' in register 0x01 (PMU_WAKEUP_EVENTS).

- Notes:
1. WAKEUP0 and PWREN pins must be driven with V_{BACKUP} level, WAKEUP{1,2,3} pins must be driven with V_{PAD} level.
 2. If any WAKEUP EVENT is triggered while AT73C246 is going from RUN to STANDBY state, STANDBY state is then first reached before WAKEUP EVENT is taken into account.

11.3.7 HRST EVENT

HRST EVENT is validated if the following condition is true:

- HRST pin goes from low to high state and high state is held for more than 1s (see [Table 11-1](#)).

11.3.8 HRST RUN EVENTS

HRST RUN EVENTS are validated if all these listed conditions are true:

- HRST pin is at low level for more than 10ms (see [Table 11-1](#)).
- $V_{\text{INSYS}} > 3.1\text{V}$
- AT73C246 internal junction temperature $T_j < 110^\circ\text{C}$

Note: In case of $110^\circ\text{C} < T_j < 130^\circ\text{C}$, HRST state is maintained. The self cooling down of the die will lead to $T_j < 110^\circ\text{C}$, thus exit of HRST state.

11.3.9 HRST POWERDOWN EVENTS

HRST POWERDOWN EVENTS are validated if all of these listed conditions are true:

- HRST pin is at low level for more than 10ms.
- $V_{\text{INSYS}} < 3.1\text{V}$ or AT73C246 internal junction temperature $T_j > 130^\circ\text{C}$

Table 11-1. EVENTS Timing Table

Pin	Parameter	Comments	Min	Typ	Max	Units
PWREN	Pin at V_{BACKUP} Level. Debouncing Time.	Pin used as POWER-ON event	95	100	105	ms
PWREN	Pin at V_{BACKUP} Level. Debouncing Time.	Pin used as POWER-OFF event	4.75	5	5.25	sec
PWREN	Pin at V_{BACKUP} Level. Debouncing Time.	Pin used as WAKEUP event	9.5	10	10.5	ms
HRST	Pin at V_{BACKUP} Level. Debouncing Time.	Pin used as HRST event	0.95	1	1.05	sec
HRST	Pin at GND Level. Debouncing Time.	Pin used as HRST RUN event	9.5	10	10.5	ms
		Pin used as HRST POWERDOWN event				

Table 11-1. EVENTS Timing Table

Pin	Parameter	Comments	Min	Typ	Max	Units
WAKEUP0	Pin pulsed to V_{BACKUP} Level. Pulse Width.	Pin used as WAKEUP event	5	-	-	ns
WAKEUP1	Pin pulsed to V_{PAD} Level. Pulse Width.	Pin used as WAKEUP event	5	-	-	ns
WAKEUP2	Pin pulsed to V_{PAD} Level. Pulse Width.	Pin used as WAKEUP event	5	-	-	ns
WAKEUP3	Pin pulsed to V_{PAD} Level. Pulse Width.	Pin used as WAKEUP event	5	-	-	ns

11.4 Power Manager State Description

AT73C246 ICs are available with 2 factory programmed power sequences. The following timing diagrams refer to “SEQUENCE A” and “SEQUENCE B” programmed ICs as defined in section 17. “Ordering Information” on page 154. See also the structure of register “VERSION (0x7F)”.

11.4.1 POWERDOWN STATE

When AT73C246 is in POWERDOWN state:

- Only V_{BACKUP} supply is active. $VDD_{\{0,1,2,3,4\}}$ power supplies are OFF.
- Audio function is OFF.
- ADC function is OFF.
- RSTB pin is held low.
- Led pin is set as input with internal 120k pull-up resistor to VINSYS.
- TWI registers are reset to default value.

When the POWERDOWN state is reached from the RUN state, the CPU power supplies are switched off sequentially as described in [Figure 11-3 on page 30](#).

Figure 11-3. AT73C246 - RUN to POWERDOWN state Supplies Shutdown timing diagram.

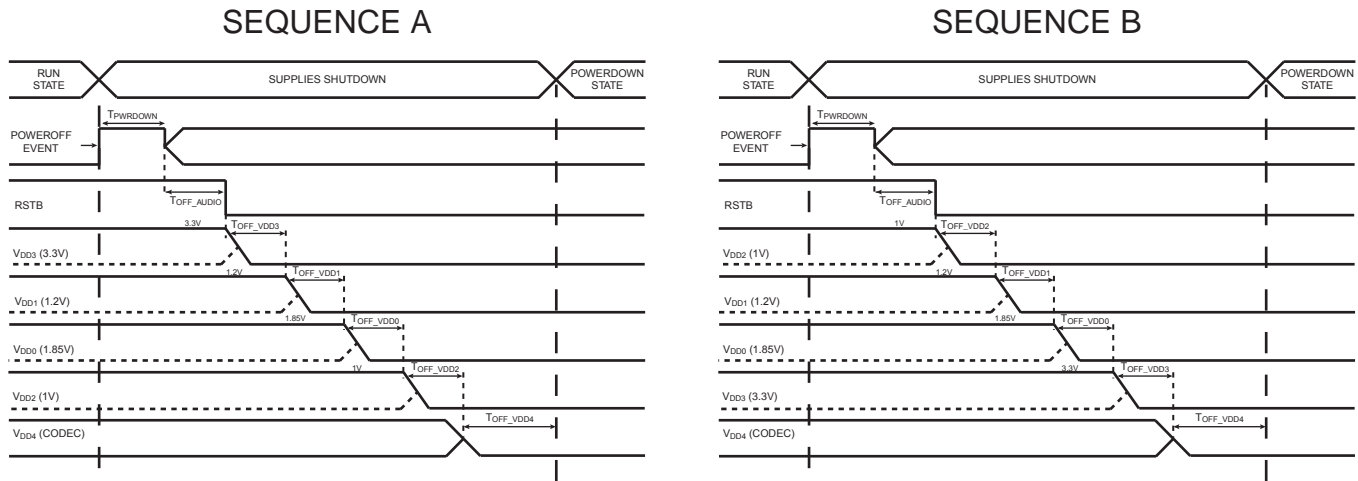

Table 11-2. RUN to POWERDOWN state timing table

Symbol	Parameter	Comments	Min	Typ	Max	Units
T _{PWRDOWN}	POWERDOWN Event detection time		58	62	66	μs
T _{OFF_AUDIO}	Audio CODEC Shutdown Time	Audio CODEC is OFF or Power Fail Occurs	58	62	66	μs
		Audio CODEC is ON	486	512	538	ms
T _{OFF_VDDx}	VDDx SHUTDOWN Time	VDDx is OFF in RUN state ⁽¹⁾	58	62	66	μs
		VDDx is ON in RUN state ⁽¹⁾	4.8	5.2	5.4	ms

Note: 1. VDDx activity during RUN state is set by Bit7 of register VDDx_CTRL.

When the POWERDOWN state is reached from the STANDBY state, the CPU power supplies are switched off sequentially as described in Figure 11-4.

Figure 11-4. AT73C246 - STANDBY to POWERDOWN state Supplies Shutdown timing diagram.

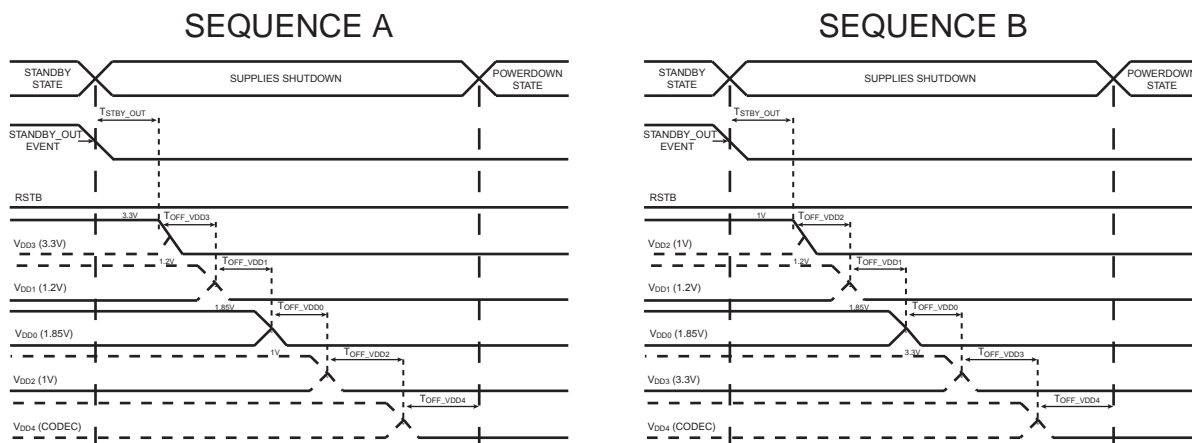

Table 11-3. STANDBY to POWERDOWN state timing table

Symbol	Parameter	Comments	Min	Typ	Max	Units
T_{STBY_OUT}	STANDBY OUT Event detection time		95	100	105	μs
T_{OFF_VDDx}	VDDx SHUTDOWN Time	VDDx is OFF during STANDBY state ⁽¹⁾	58	62	66	μs
		VDDx is ON during STANDBY state ⁽¹⁾	4.8	5.2	5.4	ms
T_{OFF_VDD4}	VDD4 SHUTDOWN Time	VDD4 is OFF in RUN state ⁽²⁾	58	62	66	μs
		VDD4 is ON in RUN state ⁽²⁾	4.8	5.2	5.4	ms

- Notes:
- VDDx activity during STANDBY state is set by register PMU_STANDBY_SUPPLIES.
 - VDD4 activity during RUN state is set by Bit7 of register VDD4_CTRL.

11.4.2 RUN STATE

When AT73C246 is in RUN state:

- VDD_{0,1,2,3,5} power supplies are ON.
- RSTB pin is released.
- PMU functions are under software control (LDO4, AUDIO CODEC, ADC Controller)
- Led pin is driven according to register PMU_LED (0x0B).

When RUN state is reached from the POWERDOWN state, the power supplies are sequentially started-up according to the [Figure 11-5](#)

Figure 11-5. AT73C246 - POWERDOWN to RUN state Supplies Start-Up timing diagram..

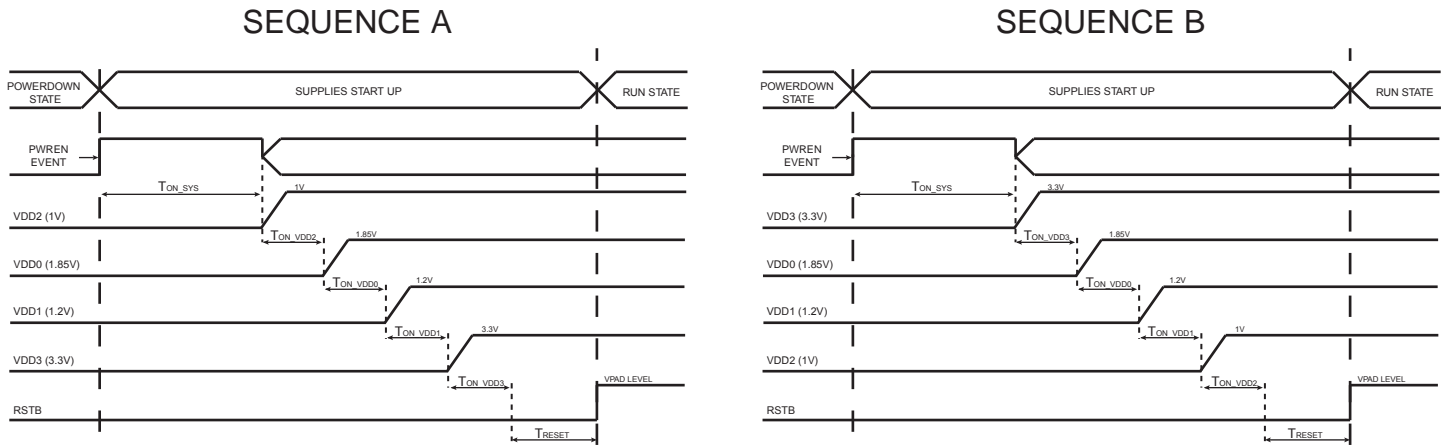

Table 11-4. POWERDOWN to RUN state timing table

Symbol	Parameter	Comments	Min	Typ	Max	Units
T_{ON_SYS}	POWER-ON Event Detection Time		1.7	1.8	1.9	ms
T_{ON_VDD0}	VDD0 Start-up Time		5	5.3	5.6	ms
T_{ON_VDD1}	VDD1 Start-up Time		5	5.3	5.6	ms
T_{ON_VDD2}	VDD2 Start-up Time		5.2	5.5	5.8	ms
T_{ON_VDD3}	VDD3 Start-up Time		5.2	5.5	5.8	ms
T_{RESET}	All Regulators ON To RSTB High		30.4	32	33.6	ms

When RUN state is reached from the STANDBY state, the power supplies are sequentially started-up according to the [Figure 11-6](#).

Figure 11-6. AT73C246 - STANDBY to RUN state Supplies Start-Up timing diagram.

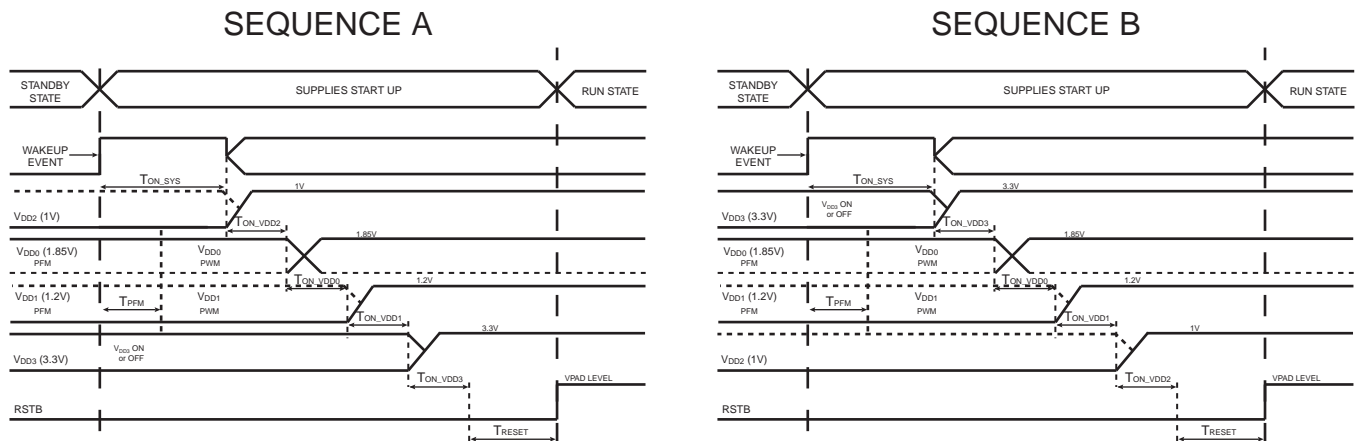

Table 11-5. STANDBY to RUN state timing table

Symbol	Parameter	Comments	Min	Typ	Max	Units
T _{ON_SYS}	Start-up Time	Time from validated WAKEUP event (end of debounce time when applicable) to VDD2 or VDD3 power on.	810	900	990	µs
T _{PFM}	PFM/PWM Switching time	Time from validated WAKEUP event (end of debounce time when applicable) to PFM/PWM switching if applicable.	420	470	520	µs
T _{ON_VDDx}	VDDx Start-up Time	VDDx is OFF during STANDBY state ⁽¹⁾	5.2	5.4	5.7	ms
		VDDx is ON during STANDBY state ⁽¹⁾	58	62	66	µs
T _{RESET}	All Regulators ON To RSTB High		30.4	32	33.6	ms

Note: 1. VDDx activity during STANDBY state is set by register PMU_STANDBY_SUPPLIES.

11.4.3 STANDBY STATE

When AT73C246 is in STANDBY state:

- V_{BACKUP} is ON.
- VDD_{0,1,2,3} are ON or OFF according to the status in register 0x03 (PMU_STANDBY_SUPPLIES)
- VDD₄ is ON or OFF according to the status in register 0x0A (VDD4_CTRL)
- Audio function is OFF
- ADC function is ON or OFF according to the status in register 0x30 (ADC_CTRL)
- RSTB pin is forced to ground.
- TWI pins are ignored to prevent TWI registers from corruption
- Led pin is driven according to register PMU_LED (0x0B)

To reach the STANDBY state, the appropriate power supplies are shut down as described in the [Figure 11-7 on page 34](#).

Figure 11-7. AT73C246 - RUN to STANDBY state Supplies Shutdown timing diagram.

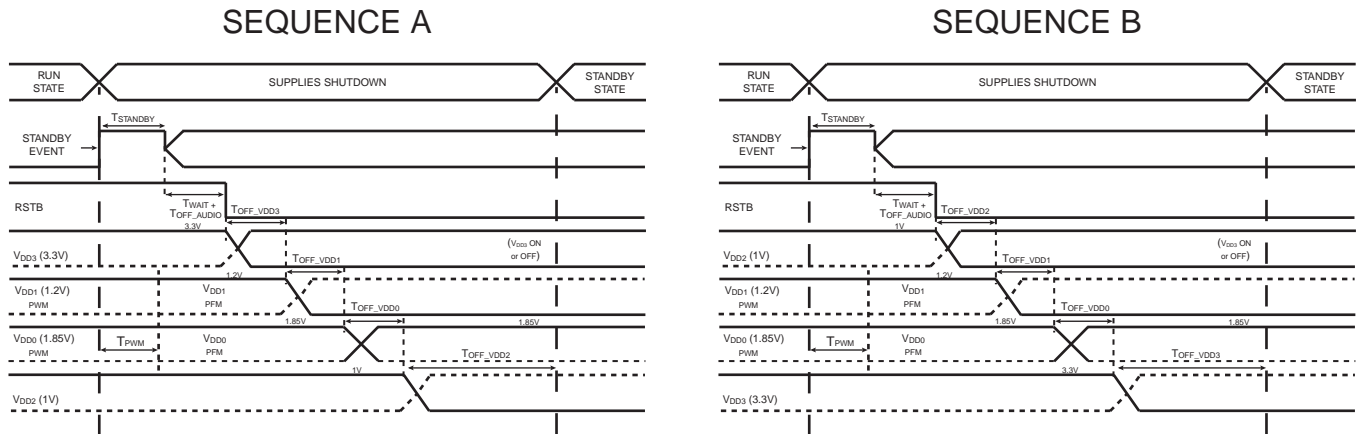

Table 11-6. RUN to STANDBY state timing table

Symbol	Parameter	Comments	Min	Typ	Max	Units
$T_{STANDBY}$	STANDBY Event Detection Time		150	160	170	μs
T_{PWM}	PFM/PWM Switching time	Time from validated WAKEUP event (end of debounce time when applicable) to PFM/PWM switching if applicable.	460	500	540	μs
T_{WAIT}	WAKEUP Event Detection Window	If a WAKEUP event occurs in this window the PMU automatically restart at the end of the STANDBY process.	150	160	170	μs
T_{OFF_AUDIO}	Audio CODEC Shutdown Time	Audio CODEC is ON	486	512	538	ms
		Audio CODEC is OFF	58	62	66	μs
T_{OFF_VDDx}	VDDx SHUTDOWN Time	VDDx is OFF during both STANBY ⁽¹⁾ and RUN ⁽²⁾ states.	58	62	66	μs
		VDDx is OFF during STANBY state ⁽¹⁾ . VDDx is ON during RUN state ⁽²⁾ .	4.8	5.2	5.4	ms
T_{ON_VDDx}	VDDx STARTUP Time	VDDx is ON during STANBY state ⁽¹⁾ . VDDx is OFF during RUN state ⁽²⁾ .	4.8	5.2	5.4	ms
		VDDx is ON during both STANBY ⁽¹⁾ and RUN ⁽²⁾ states.	58	62	66	μs

- Note:
- VDDx activity during STANDBY state is set by register PMU_STANDBY_SUPPLIES.
 - VDDx activity during RUN state is set by Bit7 of register VDDx_CTRL.

11.4.4 HRST STATE

HRST state is a transition state used to restart the CPU:

- VDD_{0,1,2,3,4} are switched off according to figure [Figure 11-8 on page 35](#) depending on the previous state
- VDD₅ is ON
- RSTB pin is forced to ground

Figure 11-8. AT73C246 - HRST state Supplies Shutdown timing diagram.

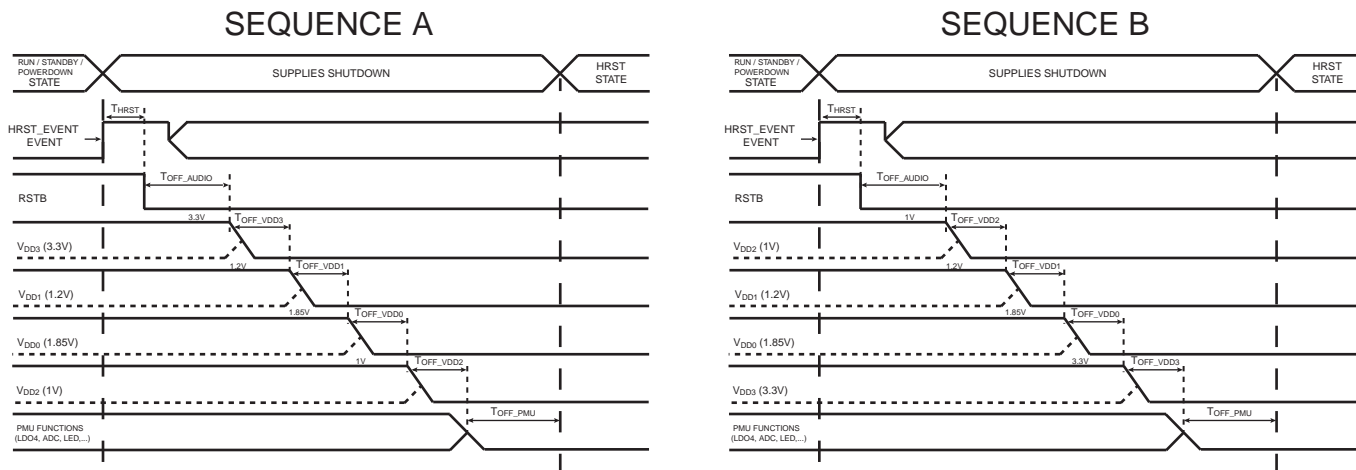

Table 11-7. HRST state timing table from RUN STATE

Symbol	Parameter	Comments	Min	Typ	Max	Units
T_{HRST}	HRST Event Detection Time		58	62	66	μs
T_{OFF_AUDIO}	Audio CODEC Shutdown Time	Audio CODEC is ON	486	512	538	ms
		Audio CODEC is OFF	58	62	66	μs
T_{OFF_VDDx}	VDDx SHUTDOWN Time	VDDx is OFF in RUN state ⁽¹⁾	58	62	66	μs
		VDDx is ON in RUN state ⁽¹⁾	4.8	5.2	5.4	ms
T_{OFF_PMU}	PMU Functions Shutdown Time		1.4	1.5	1.6	ms

Note: 1. VDDx activity during RUN state is set by Bit7 of register VDDx_CTRL

Table 11-8. HRST state timing table from STANDBY STATE

Symbol	Parameter	Comments	Min	Typ	Max	Units
T_{HRST}	HRST Event Detection Time		58	62	66	μs
T_{OFF_AUDIO}	Audio CODEC Shutdown Time	Audio CODEC is ON	486	512	538	ms
		Audio CODEC is OFF	58	62	66	μs
T_{OFF_VDDx}	VDDx SHUTDOWN Time	VDDx is OFF during STANDBY state ⁽¹⁾	58	62	66	μs
		VDDx is ON during STANDBY state ⁽¹⁾	4.8	5.2	5.4	ms
T_{OFF_VDD4}	VDD4 SHUTDOWN Time	VDD4 is OFF in RUN state ⁽²⁾	58	62	66	μs
		VDD4 is ON in RUN state ⁽²⁾	4.8	5.2	5.4	ms
T_{OFF_PMU}	PMU Functions Shutdown Time		1.4	1.5	1.6	ms

Notes: 1. VDDx activity during STANDBY state is set by register PMU_STANDBY_SUPPLIES.

2. VDD4 activity during RUN state is set by Bit7 of register VDD4_CTRL.

11.5 DCDC0 and DCDC1 Functional Description

DCDC0 and DCDC1 are 2 identical high performance synchronous step-down (buck) converters. They feature:

- 2 control modes: PFM and PWM,
- A soft start circuit,
- A software programmable output voltage between 0.8 and 3.6V with automatic ramping for DVS application,
- An Over-Current-Protection circuit,
- A 180 degree out of phase operating mode.

11.5.1 PFM and PWM Control Modes

Pulse Frequency Modulation control is an hysteretic control of the output voltage. It is specially intended for light loads (< 50mA typ). In this mode, the DCDC converter exhibits a very low quiescent current (< 50 μ A) thus achieving very high efficiency at light loads. The frequency of operation in this mode is not fixed but proportional to the load current.

Pulse Width Modulation control is a fixed frequency, variable duty cycle control of the DCDC converter. It has a fast and precise feedback loop specially intended to handle hard loads and low output ripple voltage.

At start-up, DCDC0 and DCDC1 operate in PWM mode. This way, high load at CPU boot are properly handled. Through software control in registers VDD0_CTRL (0x06) and VDD1_CTRL (0x07), the user may enter the low-power mode (PFM) when the application consumption is reduced.

11.5.2 Soft-start Circuit

DCDC0 and DCDC1 feature a soft start circuit to prevent high input current while charging the output capacitor from 0V to the default output voltage. Typically, the in-rush current at start-up (with no load) is limited to 30 mA.

11.5.3 Output Voltage Programming

DCDC0 and DCDC1 output voltages can be managed through software control in registers VDD0_CTRL (0x06) and VDD1_CTRL (0x07). 50mV steps are provided from 0.8V to 3.6V. It is recommended to use the automatic ramping function in register PMU_SUPPLY_CTRL (0x04) to achieve smooth operation. When the DVS_VDD_{0,1} bit is active (default mode), output voltages are ramped from the current value to the final value in 50mV / 280us steps. For users who intend to disable the DVS_VDD_{0,1} bit, a maximum of 4 steps (= 200mV) per 100us is allowed.

At power up, DCDC0 and DCDC1 default output voltages are respectively 1.85V and 1.20V. For different default output voltages, please contact Atmel.

11.5.4 180° Out-of-phase Operation

DCDC0 and DCDC1 can be operated in-phase or at 180° out-of-phase according to the selection bit in register PMU_SUPPLY_CTRL (0x04). When operated in phase both converters will start charging their inductor at the same time. When operated at 180° out-of-phase, the inductor charge start time will be shifted by half a 2MHz clock delay (= 250ns) from one converter to the other. This latter scheme tends to average the input current of both DCDC converters.

11.6 LDO2 Functional Description

LDO2 is a linear voltage regulator intended to supply CPU core voltages in the range 0.8V to 1.35V. Its maximum input voltage is 3.6V. Thus, it must not be wired to the VIN plane with VINSYS, VIN0, VIN1, VIN3 and VIN4 if VIN is above 3.6V. Considering its low-output voltage and for the sake of efficiency and power dissipation, the user may connect it at the output of DCDC0.

This LDO features:

- A soft start circuit,
- A software programmable output voltage between 0.8 and 1.35V with automatic ramping for DVS application.

11.6.1 Soft-start Circuit

LDO2 features a soft start circuit to prevent high input current while charging the output capacitor from 0V to the default output voltage. This soft start circuit limits the input current during 5ms (+/-5%) at startup to 200mA in typical conditions. After this delay, LDO2 recovers full current capability.

11.6.2 Output Voltage Programming

LDO2 output voltage can be managed through software control in register VDD2_CTRL (0x08). 50mV steps are provided from 0.8V to 1.35V. It is recommended to use the automatic ramping function in register PMU_SUPPLY_CTRL (0x04) to achieve smooth operation. When the DVS_VDD2 bit is active (default mode), output voltages are ramped from the current value to the final value in 50mV / 600us steps.

At power up, LDO2 default output voltage is 1V. For different default output voltage, please contact Atmel.

11.7 LDO3 and LDO4 Functional Description

LDO3 and LDO4 are low dropout linear voltage regulators intended to supply CPU peripherals (I/Os, analog functions) in the range 2.7V to 3.6V. They can be operated directly from a 5.5V maximum input voltage. They feature:

- A soft start circuit,
- A software programmable output between 2.7V and 3.6V voltage with automatic ramping for DVS application,

11.7.1 Soft-start Circuit

LDO3 and LDO4 feature a soft start circuit to prevent high input current while charging the output capacitor from 0V to the default output voltage. This soft start circuit limits the input current during 5ms (+/-5%) at startup to 200mA in typical conditions. After this delay, LDO3(4) recovers full current capability.

11.7.2 Output Voltage Programming

LDO3 and LDO4 output voltages can be managed through software control in registers VDD3_CTRL (0x09) and VDD4_CTRL (0x0A). 50mV steps are provided from 2.7V to 3.6V. It is recommended to use the automatic ramping function in register PMU_SUPPLY_CTRL (0x04) to achieve smooth operation. When the DVS_VDD_{3,4} bit is active (default mode), output voltages are ramped from the current value to the final value in 50mV / 600us steps.

At power up, LDO3 and LDO4 default output voltages are both 3.3V. For different default output voltages, please contact Atmel.

11.8 Power Fail Detectors

AT73C246 features a Power Fail detector on each CPU supplies (V_{DD0} , V_{DD1} , V_{DD2} , V_{DD3}). This function is made of a comparator that toggles each time one of the listed power supplies goes below a defined threshold. The comparator toggling is considered by the PMU digital state machine as a POWER-FAIL event.

The threshold value of the power fail detector is proportional to the output voltage of the regulator. It is not a fixed voltage, it is adapted to the programmed output voltage. The default threshold value is set according to register PMU_RST_LVL (0x05) and can be programmed to another value through TWI access. For other default threshold values at startup, please contact Atmel.

11.9 Measurement Bridge and 10-bit ADC

AT73C246 features a 10-channel measurement chain including:

- A multiplexer + attenuator followed by a unity gain buffer
- A 300kS/s 10-bit SAR ADC.

ADC function is enabled through the register ADC_CTRL (0x30). ADC_MUX_1 (0x31) and ADC_MUX_2 (0x32) allow the selection of inputs to be measured. 1 to 10 inputs can be selected. The ADC will then perform serial conversion on these inputs and write the corresponding result in registers 0x33 to 0x49.

2 sampling modes are provided to perform periodic conversions:

- Max speed
- Low speed.

To enter these modes, refer to the sampling period bits (TS) in the register ADC_CTRL (0x30).

When MAX_SPEED mode is selected, the ADC runs at 300kS/s and loops without any dead time over the selected inputs. When a LOW_SPEED sampling period is selected, the ADC performs a set of input conversions (1 to 10) at 300kS/s and then waits for one sampling period (defined by TS bits) to start another set of conversions.

Figure 11-9. Measurement Bridge and 10-bit ADC Block Diagram.

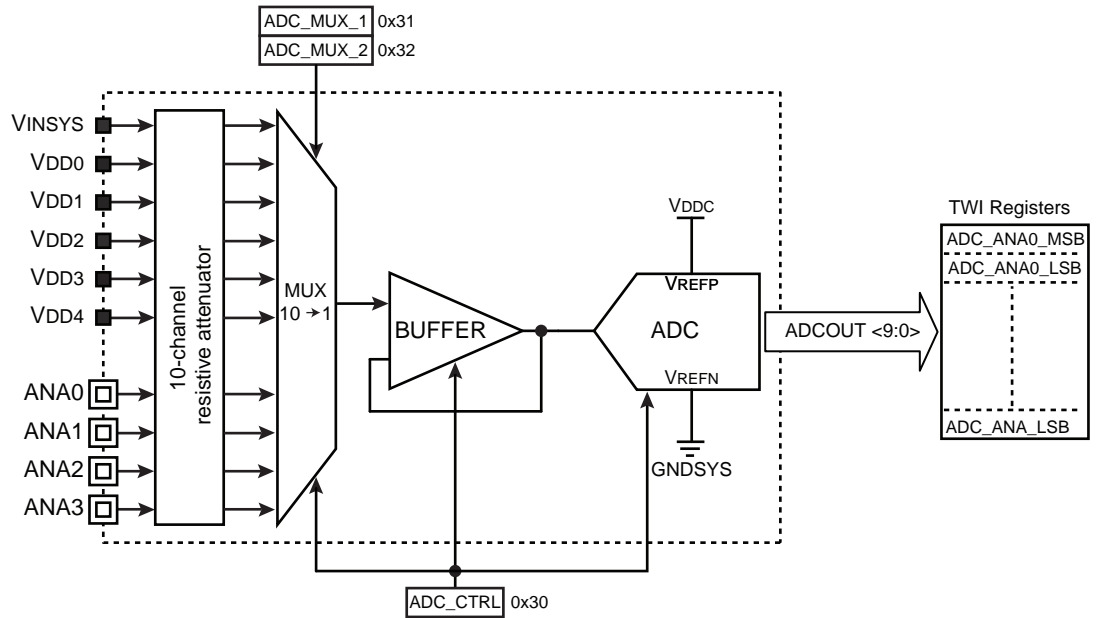

11.10 Real Time Clock (RTC) User Interface

Figure 11-10. RTC Block Diagram

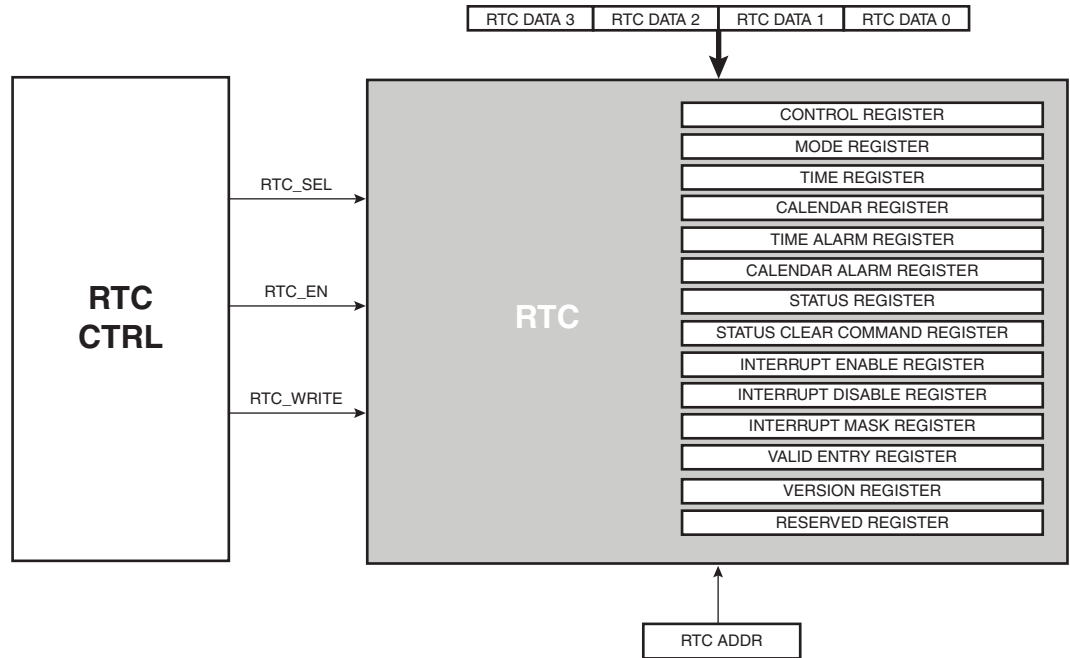

Table 11-9. Register Mapping

Offset	Register	Name	Access	Reset
0x00	Control Register	RTC_CR	Read-write	0x0
0x04	Mode Register	RTC_MR	Read-write	0x0
0x08	Time Register	RTC_TIMR	Read-write	0x0
0x0C	Calendar Register	RTC_CALR	Read-write	0x01819819
0x10	Time Alarm Register	RTC_TIMALR	Read-write	0x0
0x14	Calendar Alarm Register	RTC_CALALR	Read-write	0x01010000
0x18	Status Register	RTC_SR	Read-only	0x0
0x1C	Status Clear Command Register	RTC_SCCR	Write-only	---
0x20	Interrupt Enable Register	RTC_IER	Write-only	---
0x24	Interrupt Disable Register	RTC_IDR	Write-only	---
0x28	Interrupt Mask Register	RTC_IMR	Read-only	0x0
0x2C	Valid Entry Register	RTC_VER	Read-only	0x0
0xFC	Version Register ⁽¹⁾	RTC_VERSION	Read-only	---
0xFC	Reserved Register	---	---	---

Note: 1. Values in the Version Register vary with the version of the IP block implementation.

11.10.1 RTC Register Read/Write Operation

Figure 11-11. RTC Read Operation

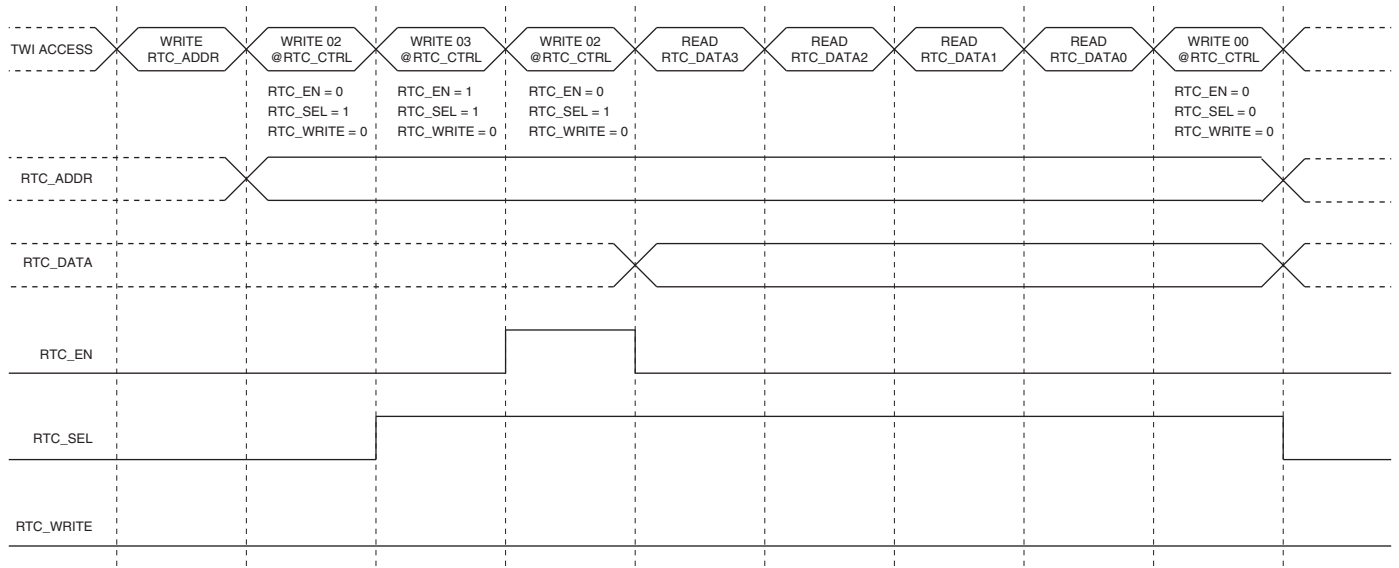
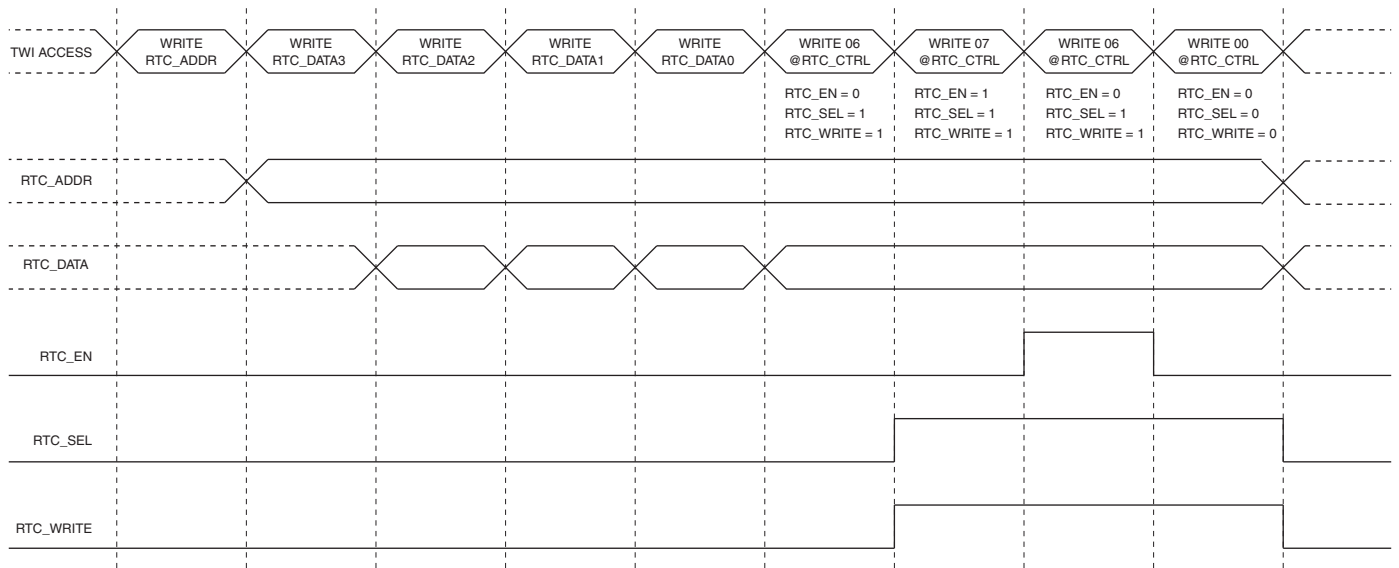

Figure 11-12. RTC Write Operation



11.10.2 RTC Control Register

Name: RTC_CR
Access: Read-write
Address: 0x00

31	30	29	28	27	26	25	24
–	–	–	–	–	–	–	–
23	22	21	20	19	18	17	16
–	–	–	–	–	–	CALEVSEL	
15	14	13	12	11	10	9	8
–	–	–	–	–	–	TIMEVSEL	
7	6	5	4	3	2	1	0
–	–	–	–	–	–	UPDCAL	UPDTIM

- **UPDTIM: Update Request Time Register**

0 = No effect.

1 = Stops the RTC time counting.

Time counting consists of second, minute and hour counters. Time counters can be programmed once this bit is set and acknowledged by the bit ACKUPD of the Status Register.

- **UPDCAL: Update Request Calendar Register**

0 = No effect.

1 = Stops the RTC calendar counting.

Calendar counting consists of day, date, month, year and century counters. Calendar counters can be programmed once this bit is set.

- **TIMEVSEL: Time Event Selection**

The event that generates the flag TIMEV in RTC_SR (Status Register) depends on the value of TIMEVSEL.

0 = Minute change.

1 = Hour change.

2 = Every day at midnight.

3 = Every day at noon.

- **CALEVSEL: Calendar Event Selection**

The event that generates the flag CALEV in RTC_SR depends on the value of CALEVSEL.

0 = Week change (every Monday at time 00:00:00).

1 = Month change (every 01 of each month at time 00:00:00).

2, 3 = Year change (every January 1 at time 00:00:00)

11.10.3 RTC Mode Register

Name: RTC_MR

Access: Read-write

Address: 0x04

31	30	29	28	27	26	25	24
–	–	–	–	–	–	–	–
23	22	21	20	19	18	17	16
–	–	–	–	–	–	–	–
15	14	13	12	11	10	9	8
–	–	–	–	–	–	–	–
7	6	5	4	3	2	1	0
–	–	–	–	–	–	–	HRMOD

• **HRMOD: 12-/24-hour Mode**

0 = 24-hour mode is selected.

1 = 12-hour mode is selected.

All non-significant bits read zero.

11.10.4 RTC Time Register

Name: RTC_TIMR

Access: Read-write

Address: 0x08

31	30	29	28	27	26	25	24
–	–	–	–	–	–	–	–
23	22	21	20	19	18	17	16
–	AMPM	HOUR					
15	14	13	12	11	10	9	8
–	MIN						
7	6	5	4	3	2	1	0
–	SEC						

- **SEC: Current Second**

The range that can be set is 0 - 59 (BCD).

The lowest four bits encode the units. The higher bits encode the tens.

- **MIN: Current Minute**

The range that can be set is 0 - 59 (BCD).

The lowest four bits encode the units. The higher bits encode the tens.

- **HOUR: Current Hour**

The range that can be set is 1 - 12 (BCD) in 12-hour mode or 0 - 23 (BCD) in 24-hour mode.

- **AMPM: Ante Meridiem Post Meridiem Indicator**

This bit is the AM/PM indicator in 12-hour mode.

0 = AM.

1 = PM.

All non-significant bits read zero.

11.10.5 RTC Calendar Register

Name: RTC_CALR

Access: Read-write

Address: 0x0C

31	30	29	28	27	26	25	24
–	–	DATE					
23	22	21	20	19	18	17	16
DAY				MONTH			
15	14	13	12	11	10	9	8
YEAR							
7	6	5	4	3	2	1	0
–	CENT						

• **CENT: Current Century**

The range that can be set is 19 - 20 (BCD).

The lowest four bits encode the units. The higher bits encode the tens.

• **YEAR: Current Year**

The range that can be set is 00 - 99 (BCD).

The lowest four bits encode the units. The higher bits encode the tens.

• **MONTH: Current Month**

The range that can be set is 01 - 12 (BCD).

The lowest four bits encode the units. The higher bits encode the tens.

• **DAY: Current Day**

The range that can be set is 1 - 7 (BCD).

The coding of the number (which number represents which day) is user-defined as it has no effect on the date counter.

• **DATE: Current Date**

The range that can be set is 01 - 31 (BCD).

The lowest four bits encode the units. The higher bits encode the tens.

All non-significant bits read zero.

11.10.6 RTC Time Alarm Register

Name: RTC_TIMALR

Access: Read-write

Address: 0x10

31	30	29	28	27	26	25	24
–	–	–	–	–	–	–	–
23	22	21	20	19	18	17	16
HOUREN	AMPM	HOUR					
15	14	13	12	11	10	9	8
MINEN	MIN						
7	6	5	4	3	2	1	0
SECEN	SEC						

- **SEC: Second Alarm**

This field is the alarm field corresponding to the BCD-coded second counter.

- **SECEN: Second Alarm Enable**

0 = The second-matching alarm is disabled.

1 = The second-matching alarm is enabled.

- **MIN: Minute Alarm**

This field is the alarm field corresponding to the BCD-coded minute counter.

- **MINEN: Minute Alarm Enable**

0 = The minute-matching alarm is disabled.

1 = The minute-matching alarm is enabled.

- **HOUR: Hour Alarm**

This field is the alarm field corresponding to the BCD-coded hour counter.

- **AMPM: AM/PM Indicator**

This field is the alarm field corresponding to the BCD-coded hour counter.

- **HOUREN: Hour Alarm Enable**

0 = The hour-matching alarm is disabled.

1 = The hour-matching alarm is enabled.

11.10.7 RTC Calendar Alarm Register

Name: RTC_CALALR

Access: Read-write

Address: 0x14

31	30	29	28	27	26	25	24
DATEEN	-	DATE					
23	22	21	20	19	18	17	16
MTHEN	-	-	MONTH				
15	14	13	12	11	10	9	8
-	-	-	-	-	-	-	-
7	6	5	4	3	2	1	0
-	-	-	-	-	-	-	-

- **MONTH: Month Alarm**

This field is the alarm field corresponding to the BCD-coded month counter.

- **MTHEN: Month Alarm Enable**

0 = The month-matching alarm is disabled.

1 = The month-matching alarm is enabled.

- **DATE: Date Alarm**

This field is the alarm field corresponding to the BCD-coded date counter.

- **DATEEN: Date Alarm Enable**

0 = The date-matching alarm is disabled.

1 = The date-matching alarm is enabled.

11.10.8 RTC Status Register

Name: RTC_SR
Access: Read-only
Address: 0x18

31	30	29	28	27	26	25	24
–	–	–	–	–	–	–	–
23	22	21	20	19	18	17	16
–	–	–	–	–	–	–	–
15	14	13	12	11	10	9	8
–	–	–	–	–	–	–	–
7	6	5	4	3	2	1	0
–	–	–	CALEV	TIMEV	SEC	ALARM	ACKUPD

- **ACKUPD: Acknowledge for Update**

0 = Time and calendar registers cannot be updated.
 1 = Time and calendar registers can be updated.

- **ALARM: Alarm Flag**

0 = No alarm matching condition occurred.
 1 = An alarm matching condition has occurred.

- **SEC: Second Event**

0 = No second event has occurred since the last clear.
 1 = At least one second event has occurred since the last clear.

- **TIMEV: Time Event**

0 = No time event has occurred since the last clear.
 1 = At least one time event has occurred since the last clear.

The time event is selected in the TIMEVSEL field in RTC_CTRL (Control Register) and can be any one of the following events: minute change, hour change, noon, midnight (day change).

- **CALEV: Calendar Event**

0 = No calendar event has occurred since the last clear.
 1 = At least one calendar event has occurred since the last clear.

The calendar event is selected in the CALEVSEL field in RTC_CR and can be any one of the following events: week change, month change and year change.

11.10.9 RTC Status Clear Command Register

Name: RTC_SCCR

Access: Write-only

Address: 0x1C

31	30	29	28	27	26	25	24
–	–	–	–	–	–	–	–
23	22	21	20	19	18	17	16
–	–	–	–	–	–	–	–
15	14	13	12	11	10	9	8
–	–	–	–	–	–	–	–
7	6	5	4	3	2	1	0
–	–	–	CALCLR	TIMCLR	SECCLR	ALRCLR	ACKCLR

- **ACKCLR: Acknowledge Clear**

0 = No effect.

1 = Clears corresponding status flag in the Status Register (RTC_SR).

- **ALRCLR: Alarm Clear**

0 = No effect.

1 = Clears corresponding status flag in the Status Register (RTC_SR).

- **SECCLR: Second Clear**

0 = No effect.

1 = Clears corresponding status flag in the Status Register (RTC_SR).

- **TIMCLR: Time Clear**

0 = No effect.

1 = Clears corresponding status flag in the Status Register (RTC_SR).

- **CALCLR: Calendar Clear**

0 = No effect.

1 = Clears corresponding status flag in the Status Register (RTC_SR).

11.10.10 RTC Interrupt Enable Register

Name: RTC_IER

Access: Write-only

Address: 0x20

31	30	29	28	27	26	25	24
–	–	–	–	–	–	–	–
23	22	21	20	19	18	17	16
–	–	–	–	–	–	–	–
15	14	13	12	11	10	9	8
–	–	–	–	–	–	–	–
7	6	5	4	3	2	1	0
–	–	–	CALEN	TIMEN	SECEN	ALREN	ACKEN

- **ACKEN: Acknowledge Update Interrupt Enable**

0 = No effect.

1 = The acknowledge for update interrupt is enabled.

- **ALREN: Alarm Interrupt Enable**

0 = No effect.

1 = The alarm interrupt is enabled.

- **SECEN: Second Event Interrupt Enable**

0 = No effect.

1 = The second periodic interrupt is enabled.

- **TIMEN: Time Event Interrupt Enable**

0 = No effect.

1 = The selected time event interrupt is enabled.

- **CALEN: Calendar Event Interrupt Enable**

0 = No effect.

• 1 = The selected calendar event interrupt is enabled.

11.10.11 RTC Interrupt Disable Register

Name: RTC_IDR

Access: Write-only

Address: 0x24

31	30	29	28	27	26	25	24
–	–	–	–	–	–	–	–
23	22	21	20	19	18	17	16
–	–	–	–	–	–	–	–
15	14	13	12	11	10	9	8
–	–	–	–	–	–	–	–
7	6	5	4	3	2	1	0
–	–	–	CALDIS	TIMDIS	SECDIS	ALRDIS	ACKDIS

- **ACKDIS: Acknowledge Update Interrupt Disable**

0 = No effect.

1 = The acknowledge for update interrupt is disabled.

- **ALRDIS: Alarm Interrupt Disable**

0 = No effect.

1 = The alarm interrupt is disabled.

- **SECDIS: Second Event Interrupt Disable**

0 = No effect.

1 = The second periodic interrupt is disabled.

- **TIMDIS: Time Event Interrupt Disable**

0 = No effect.

1 = The selected time event interrupt is disabled.

- **CALDIS: Calendar Event Interrupt Disable**

0 = No effect.

1 = The selected calendar event interrupt is disabled.

11.10.12 RTC Interrupt Mask Register

Name: RTC_IMR

Access: Read-only

Address: 0x28

31	30	29	28	27	26	25	24
–	–	–	–	–	–	–	–
23	22	21	20	19	18	17	16
–	–	–	–	–	–	–	–
15	14	13	12	11	10	9	8
–	–	–	–	–	–	–	–
7	6	5	4	3	2	1	0
–	–	–	CAL	TIM	SEC	ALR	ACK

- **ACK: Acknowledge Update Interrupt Mask**

0 = The acknowledge for update interrupt is disabled.

1 = The acknowledge for update interrupt is enabled.

- **ALR: Alarm Interrupt Mask**

0 = The alarm interrupt is disabled.

1 = The alarm interrupt is enabled.

- **SEC: Second Event Interrupt Mask**

0 = The second periodic interrupt is disabled.

1 = The second periodic interrupt is enabled.

- **TIM: Time Event Interrupt Mask**

0 = The selected time event interrupt is disabled.

1 = The selected time event interrupt is enabled.

- **CAL: Calendar Event Interrupt Mask**

0 = The selected calendar event interrupt is disabled.

1 = The selected calendar event interrupt is enabled.

11.10.13 RTC Valid Entry Register

Name: RTC_VER

Access: Read-only

Address: 0x2C

31	30	29	28	27	26	25	24
–	–	–	–	–	–	–	–
23	22	21	20	19	18	17	16
–	–	–	–	–	–	–	–
15	14	13	12	11	10	9	8
–	–	–	–	–	–	–	–
7	6	5	4	3	2	1	0
–	–	–	–	NVCALALR	NVTIMALR	NVCAL	NVTIM

• **NVTIM: Non-valid Time**

0 = No invalid data has been detected in RTC_TIMR (Time Register).

1 = RTC_TIMR has contained invalid data since it was last programmed.

• **NVCAL: Non-valid Calendar**

0 = No invalid data has been detected in RTC_CALR (Calendar Register).

1 = RTC_CALR has contained invalid data since it was last programmed.

• **NVTIMALR: Non-valid Time Alarm**

0 = No invalid data has been detected in RTC_TIMALR (Time Alarm Register).

1 = RTC_TIMALR has contained invalid data since it was last programmed.

• **NVCALALR: Non-valid Calendar Alarm**

0 = No invalid data has been detected in RTC_CALALR (Calendar Alarm Register).

1 = RTC_CALALR has contained invalid data since it was last programmed.

11.10.14 RTC Version register

Name: RTC_VERSION

Access: Read-only

Address: 0xFC

31	30	29	28	27	26	25	24
–	–	–	–	–	–	–	–
23	22	21	20	19	18	17	16
–	–	–	–	–	MFN		
15	14	13	12	11	10	9	8
–	–	–	–	VERSION			
7	6	5	4	3	2	1	0
VERSION							

- VERSION

Reserved. Value subject to change. No functionality associated. This is the Atmel internal version of the macrocell.

- MFN

Reserved. Value subject to change. No functionality associated.

11.11 Die Temperature Sensor

The AT73C246 features a die temperature sensor for protection reasons. If the junction temperature rises above the shutdown threshold for a minimum time of 1ms (+/- 5%), the power manager event $T_j > 130^\circ\text{C}$ is asserted. In a similar fashion, if the temperature falls through the restart threshold for more than 1ms, the power manager event $T_j < 110^\circ\text{C}$ is asserted.

The two internal thresholds shutdown and restart are defined in [Section 9.11 “Die Temperature Sensor”](#) on page 21.

12. Audio Codec Functional Description

12.1 Description

AT73C246 features a high quality, low power stereo audio codec with integrated headphone amplifier.

The playback channel accommodates 16 to 24-bit stereo programmable format entering the digital audio interface (I²S) and delivers an internal analog audio output through a 100dB SNR Sigma Delta Stereo DAC. An output mixer allows to mix this DAC output with a line / aux or microphone input.

A 16-32 Ohms Stereo headphone amplifier with virtual ground output provides a 97dB SNR output for line / headphone loads. The virtual ground output allows to remove 2 space demanding coupling capacitors on board.

On the record side, a multiplexer can select between a main stereo line input and a stereo auxiliary input such as an FM radio. A stereo microphone input with up to 46dB gain is provided. A stereo input mixer allows mixing between line (or aux) and microphone channels before entering a 96dB SNR Stereo Sigma Delta ADC. The digital audio signal is then digitally filtered and transferred to the I²S audio interface.

12.2 Audio Codec Block Diagram

Figure 12-1. Audio Codec Block Diagram

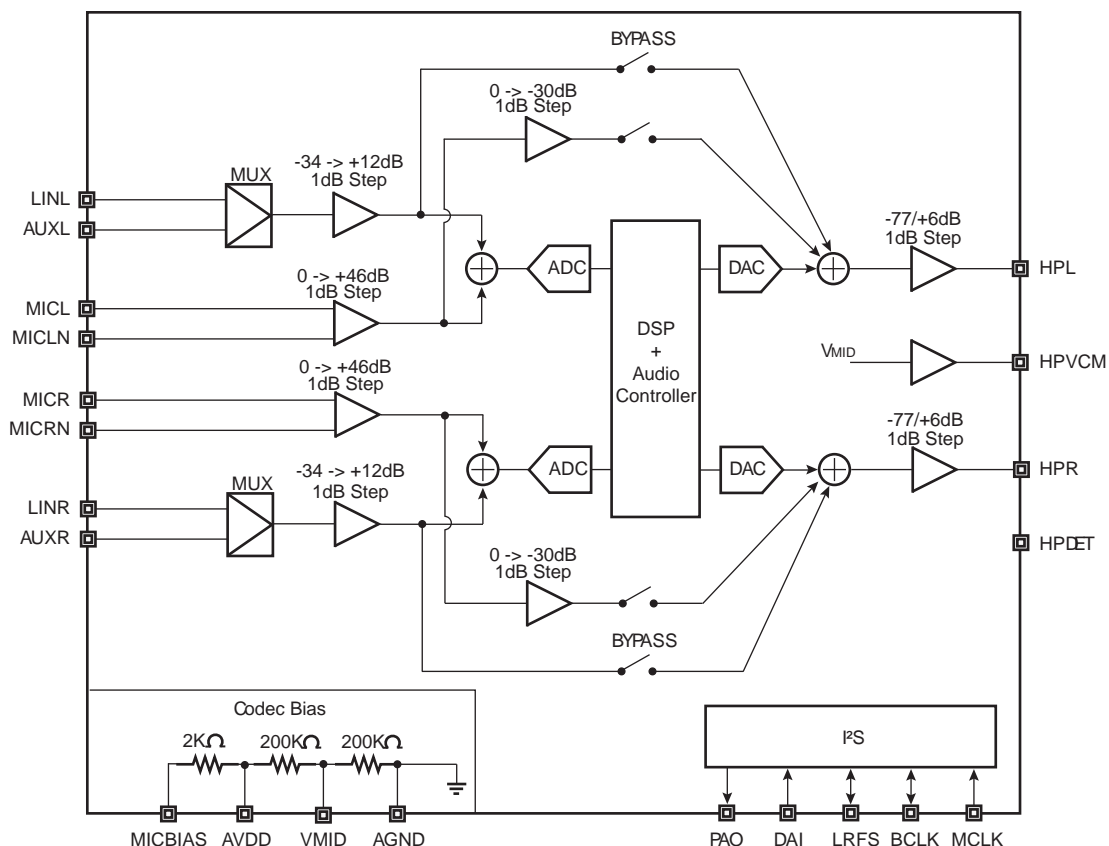

12.4 Audio Controller

The audio controller sequences the power-up and power-down of the audio codec sub-functions (Mic.amp / ADC / DAC / ...). During these transitioning phases, the controller also manages the gain steps to fade them in and out, thus providing smooth operation.

Depending on the application, two modes are provided:

1. Automatic path control

Dedicated to the major audio path scenarios (those described in [Table 13-25 on page 95](#)), this mode enables the whole audio path setup only via "PATHSEL" bits in register AUTOSTART (0x10).

2. Custom path control

Dedicated to audio path scenarios not described in the previously mentioned table, this mode brings the flexibility to start manually the audio sub-functions.

The following figure shows the global context of the audio codec control.

Figure 12-3. Audio Codec Typical Control Sequence

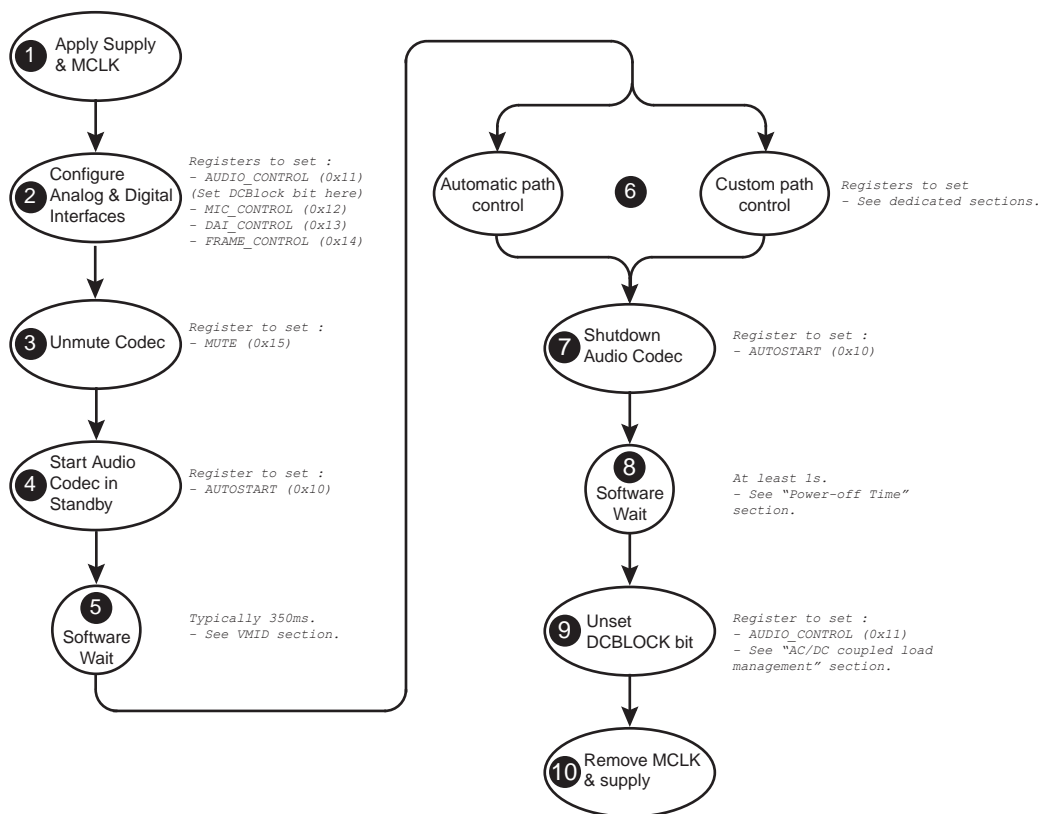

12.4.1 Audio Codec General Recommendations

12.4.1.1 V_{MID}

- V_{MID} is the common mode voltage of the audio codec analog core. It is recommended to decouple this voltage with a 1uF capacitor to ensure low noise operation as well as slow (thus silent) transients at codec power up and power down.
- The V_{MID} capacitor is charged and discharged whenever the ENAC bit is set or cleared. Particularly, placing the audio codec in STANDBY mode does not discharge the V_{MID} capacitor. The software WAIT operations in the previous diagram (step #5 and step #8 in [“Audio Codec Typical Control Sequence” on page 57](#)) should accommodate V_{MID} 's settling time constant. See [“Audio Codec Bias” on page 22](#).

12.4.1.2 AC / DC Coupled Load Management

- By default the audio codec is in DC-coupled load configuration: DCBLOCK = 0 in register AUDIO_CONTROL(0x11). In this case, a virtual ground voltage is provided on pin HPVCM (a buffered version of V_{MID}). It allows to directly connect headphones or line loads between HPVCM and HPL(or R) without any coupling capacitors. To prevent any audio pop at start-up or shutdown in this DC coupling mode, the audio codec fastly starts HPL, HPR and HPVCM outputs shorted all together. No software management is required to achieve pop-less operation.
- If output loads are AC coupled to the headphone amplifier, the audio codec DCBLOCK bit must be set and unset as described in [“Audio Codec Typical Control Sequence” on page 57](#). This bit partially controls the two switches S1 and S2 described in the following figure. When DCBLOCK = 1 and the headphone amplifier is OFF, the output coupling capacitors are charged and discharged by the amplifier “VMID_BUFFER”. In order to achieve silent startup and shutdown, the following rules must be respected:
 - DCBLOCK = 0 at supply power-on and power-off. This ensures that the LDO4 power-on and power-off transients are not transmitted to the audio loads.
 - DCBLOCK = 1 when ENAC = 1. Particularly, DCBLOCK must be set before ENAC=1 and unset after ENAC=0. This ensures that the full VMID waveform is properly buffered to the output loads.
 - DCBLOCK = 1 after ENAC = 0 and until V_{MID} capacitor is fully discharged. At codec shutdown (ENAC=0), VMID will discharge slowly. The VMID_BUFFER ensures slow and silent discharge of the output coupling capacitors, and needs S1 and S2 to be closed.

Figure 12-4. AC / DC Coupled Load Management Schematic View

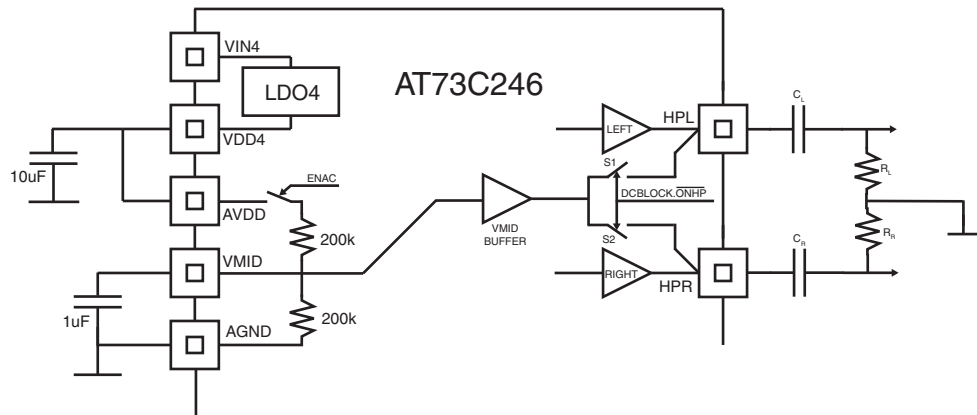
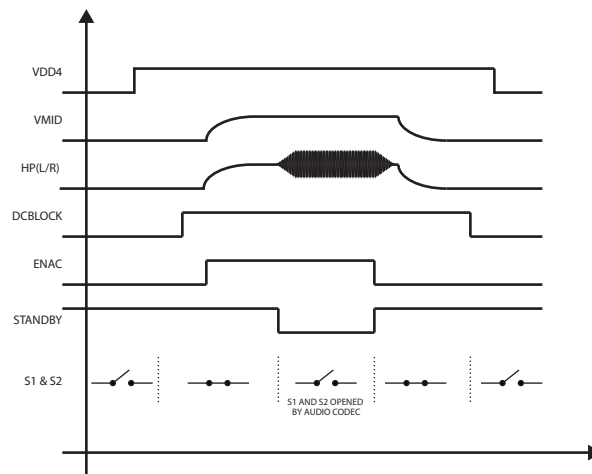

Figure 12-5. Audio Codec Typical Startup and Shutdown Waveforms With AC Coupled Loads.



12.4.1.3 MUTE Register

By default, the audio codec starts muted. To enable the audio processing, the MUTE register (0x15) must be cleared. Unmute operation can be performed before or after releasing the STANDBY mode. During operation, this register provides a convenient way of muting the audio signal without changing the various gain registers.

12.4.1.4 Master Clock Input (MCLK)

The Audio Controller is clocked by MCLK pin. Therefore a clock must be present at this pin before each codec control change. Particularly, the master clock must be present at power-on, power-off, gain change, path change. The master clock must also be available when fully analog path are used.

12.4.1.5 Power-off Conditions

Three audio codec power-off conditions can occur:

- Software request (ENAC = 0 in AUTOSTART register). In this case, the codec is smoothly powered off by the audio controller.
- PMU Power-off event or Standby event (as defined in [Section 11.3 “Power Manager Conditional Transitions” on page 27](#)). In this case, the codec is smoothly powered off with a

500ms timeout. Contrary to the first point, which has no timeout, the audio power-off time limit is here fixed to 500ms. Beyond this limit, the codec is hardly reseted as in the following point.

- PMU Power-fail event. In this case, the PMU finite state machine makes an immediate hard reset of the audio codec to ensure fast shutdown. This case may generate an audible click / pop noise.

12.4.1.6 Power-off Time

At power-off, the audio controller needs to perform several controls on audio codec sub-functions and to discharge the output coupling capacitors. Therefore, the codec's power-off time is divided into:

- a digital power-off time and,
- an analogue one.

During this power-off phase, the codec's master clock and supply must be present. See "Audio Codec Power-off Waveforms" on page 60.

Figure 12-6. Audio Codec Power-off Waveforms

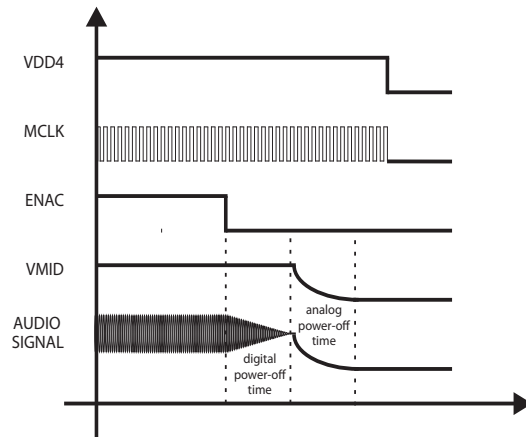

The digital power-off time depends on the number of controls (power-off, gain steps ramping, ...) to perform and for this reason strongly varies according to:

- the master clock frequency,
- the current path,
- the current gains and
- the current Automatic Soft Ramping time (ASR_TIME in AUDIO_CONTROL(0x11)).

In worst case conditions (slowest clock, maximum ASR_TIME, maximum complexity audio path, maximum gains everywhere), the power-off time reaches 3 seconds. During this period, the

master clock must be running to properly shutdown the codec. This time linearly varies with ASR_TIME value. See [Table 12-1](#)

Table 12-1. Audio Codec Maximum Power-off Time

ASR_TIME	Power-off time (ms)
00	375
01	750
10	1500
11	3000

The analog power-off time corresponds to the VMID's discharge time specified in ["Audio Codec Bias" on page 22](#): T_{MID_OFF} .

Finally, the wait step #8 in ["Audio Codec Typical Control Sequence" on page 57](#) needs to accommodate the digital power-off time + the analog power-off time.

12.4.2 Automatic Path Configuration

In this automatic path mode, the audio path control is fully managed by the AUTOSTART(0x10) register and more precisely by the following bits:

- ENAC (Enable Audio codec),
- STANDBY⁽¹⁾ (Audio standby) and
- PATHSEL (Audio path selection).

When the audio controller detects a change in these bits, it generates sequential controls to the audio codec sub-functions (power-up, gain ramping, unmute,...) with the right timing and order.

Notes: 1. Audio STANDBY does not refer to the PMU STANDBY state as defined in ["AT73C246 Power Manager Functional State Diagram" on page 25](#). The audio STANDBY mode activated by register AUTOSTART (0x10) only refers to the audio codec controller.

12.4.2.1 STANDBY Release

Once the CODEC is started and in standby mode (ENAC=1 and STANDBY=1, step #5 in ["Audio Codec Typical Control Sequence" on page 57](#)), the audio path is simply selected by PATHSEL bits.

At STANDBY release (STANDBY=0), the audio controller will:

- Power-up the requested audio sub-functions. To do so, the audio controller makes WRITE accesses to the registers
 - INPUT_CONTROL (0x1E),
 - OUTPUT_CONTROL (0x1F) and
 - INPUT_MIXER (0x20).
- Ramp-up the concerned path gains from mute to their current register value.

Notes: 1. Changing PATHSEL value with STANDBY=1 does not changes the codec state. It remains in STANDBY mode.
 2. The audio controller always ensures minimum power consumption by powering only needed sub-functions.
 3. Audio parameters (volume, mute, effects...) can be modified before or after releasing the standby mode.

12.4.2.2 *Pause Management With STANDBY Bit*

To pause the audio codec activity and reduce power consumption to few hundreds of micro-amps, the STANDBY bit can be activated in register AUTOSTART (0x10). The Audio codec will then:

- Softly ramp down all the path concerned gains down-to mute and
- Power off all the audio sub-functions. The registers INPUT_CONTROL (0x1E), OUTPUT_CONTROL (0x1F), and INPUT_MIXER (0x20) are modified by the audio controller.

Notes: 1. Placing the codec in standby mode maintains the common mode voltage at VMID pin and thus allows to re-start fastly,
 2. Standby release is simply achieved by clearing the STANDBY bit (STANDBY = 0). The procedure described in [“STANDBY Release” on page 61](#) applies.

12.4.2.3 *On-the-fly Path Change*

The audio controller is able to softly switch from one audio path configuration to another without shutting down the codec nor entering the STANDBY mode. As soon as it detects a change in the PATHSEL value, the following mechanism occurs:

- Power up and/or power down of the audio sub-functions according to the final state to reach. This operation generates automatic changes in the registers INPUT_CONTROL (0x1E), OUTPUT_CONTROL (0x1F), and INPUT_MIXER (0x20).
- Ramp up and/or ramp down of the concerned path gain.

Notes: 1. A channel may be temporarily and smoothly switched off and on to reach the new path.
 2. Any software write operation in the registers INPUT_CONTROL (0x1E), OUTPUT_CONTROL (0x1F), and INPUT_MIXER (0x20) will generate a series of control on the audio codec sub-functions. In automatic path control, the order of the write operations in those registers is of prime importance. Please note that changing those registers updates the used audio path without updating the PATHSEL value. Therefore, these write operations are not recommended and must be limited to simple ones (for example changing LINESEL bit in register INPUT_CONTROL (0x1E)).

12.4.2.4 *Audio Codec Shutdown*

The Audio controller will start to shutdown the codec if ENAC = 0. The shutdown sequence is made of the following steps:

- Softly ramp down all the path concerned gains down-to mute,
- Power off all the audio sub-functions and,
- Power off the common voltage VMID.

Notes: 1. In this mode, the power consumption is reduced to few hundreds of nA.
 2. The common mode voltage power-off follows VMID time constant and thus may take a few hundreds of milliseconds depending on VMID capacitor. See [“Audio Codec Bias” on page 22](#).

A software example of audio codec control using automatic path control is provided in the section [“Basic Audio Codec Setting Using Automatic Path Control” on page 134](#).

12.4.3 **Custom Path Configuration**

In this custom path mode, the audio path control is managed by the following registers:

- AUTOSTART (0x10) (ENAC and STANDBY bits only)
- AUDIO_CONTROL (0x11) (ENCONF and CUSTCONF bits only)

- INPUT_CONTROL (0x1E)
- OUTPUT_CONTROL (0x1F)
- INPUT_MIXER (0x20)

Like in the automatic path configuration, the audio controller will sequence audio codec sub-functions ON/OFF as well as gain stepping. However, the audio path is no more selected via the "PATHSEL" value in register AUTOSTART.

To specify a custom audio path:

- The bit CUSTCONF in register AUDIO_CONTROL (0x11) must be set to '1' to specify the 'custom' path configuration mode.
- The registers INPUT_CONTROL (0x1E), OUTPUT_CONTROL (0x1F), and INPUT_MIXER (0x20) are set to define the audio path,
- The bit ENCONF in register AUDIO_CONTROL (0x11) is pulsed to '1' to enable the audio controller sequencing.

- Notes:
1. "Pulsed to '1'" means written to '1' and then written to '0'.
 2. In this mode, the STANDBY bit behaves like in the automatic mode. It is possible to place the CODEC in standby mode to reduce power consumption during audio pause by simply setting the STANDBY bit to 1. STANDBY release is achieved by clearing this bit.
 3. On-the-fly path change is achieved by modifying the registers INPUT_CONTROL (0x1E), OUTPUT_CONTROL (0x1F), and INPUT_MIXER (0x20) to define the new audio path configuration and then pulsing to '1' the ENCONF bit. In this case, a channel may be temporarily (and smoothly) switched off and on to reach the new configuration.
 4. Changing the three registers INPUT_CONTROL (0x1E), OUTPUT_CONTROL (0x1F), and INPUT_MIXER (0x20) with the ENCONF bit set to '1' makes the changes to take effect immediately. Therefore, the order of write operations is of prime importance. It is then recommended to write these registers with ENCONF set to 0 and then pulse ENCONF to '1' once the new audio path is fully specified. Knowing the final state to reach, the audio controller is able to sequence the controls with the right order and timings to ensure noise-free operation.
 5. In this custom mode, the Audio Controller may forbid any configuration that does not make sense. For example, it will prevent the headphone amplifier from being switched on if it has no input source (DAC, Microphone, or Line).
 6. It is possible and sometimes convenient to switch from an automatically set path to a custom one. In this case, the audio controller softly performs the required path change. However, activating an automatic path configuration from a current custom path configuration is not allowed. The audio codec must be switched off first (ENAC=0).

A software example of audio codec control using custom path control is provided in the section ["Basic Audio Codec Setting Using Custom Path Control"](#) on page 135.

12.5 Audio Codec Power Consumption Versus Programmed Audio Path

Unless otherwise specified:

- $A_{VDD} = 3.3V$
- MCLK = 12.288MHz , FS = 48KHz
- All Gains set to 0dB
- No audio signal
- $T_A = 25^{\circ}C$.
- Headphone amplifier set in AC coupling mode.

- Current consumptions don't account for load consumption and are measured in A_{VDD} pin and V_{INSYS} pin.

Table 12-2. Audio PATH Power Consumption

PATH_SEL	AUDIO PATH	Description	Consumption		Units
			V_{INSYS}	A_{VDD}	
00000	No Path		0.10	0.61	mA
00001	DAC Playback	Digital IN - Headphone OUT	1.80	5.2	mA
00010	Mic Sidetone	Microphone IN - Headphone OUT	0.10	2.65	mA
00011	Aux Bypass	Aux IN - Headphone OUT	0.10	2.65	mA
00100	Line Bypass	Line IN - Headphone OUT	0.10	2.65	mA
00101	Mic Record	Mic IN - Digital OUT	2.00	3.40	mA
00110	Aux Record	Aux IN - Digital OUT	2.00	3.40	mA
00111	Line Record	Line IN - DIGITAL OUT	2.00	3.40	mA
01000	Mic Sidetone + Record	Mic IN - Headphone and Digital OUT	2.00	5.05	mA
01001	Aux Bypass + Record	Aux IN - Headphone and Digital OUT	2.00	5.05	mA
01010	Line Bypass + Record	Line IN - Headphone and Digital OUT	2.00	5.05	mA
01011	Mic + Aux Record	Mic + Aux IN - Digital OUT	2.00	3.70	mA
01100	Mic + Line Record	Mic + Line IN - Digital OUT	2.00	3.70	mA
01101	DAC Playback + Mic Sidetone	Digital + Mic IN - Headphone OUT	1.80	5.60	mA
01110	DAC Playback + Aux Bypass	Digital + Aux IN - Headphone OUT	1.80	5.60	mA
01111	DAC Playback + Line Bypass	Digital + Line IN - Headphone OUT	1.80	5.60	mA
10000	DAC Playback + Mic Sidetone + Aux Bypass	Digital + Mic + Aux IN - Headphone OUT	1.80	5.85	mA
10001	DAC Playback + Mic Sidetone + Line Bypass	Digital + Mic + Line IN - Headphone OUT	1.80	5.85	mA
10010	DAC Playback and MIC Record	Digital IN - Headphone OUT Mic IN - Digital OUT	3.80	8.00	mA
10011	DAC Playback and Aux Record	Digital IN - Headphone OUT Aux IN - Digital OUT	3.80	8.00	mA
10100	DAC Playback and Line Record	Digital IN - Headphone OUT Line IN - Digital OUT	3.80	8.00	mA
10101	DAC Playback + Mic Sidetone and Mic Record	Digital + Mic IN - Headphone OUT Mic IN - Digital OUT	3.80	8.00	mA
10110	DAC Playback + Aux Bypass and Aux Record	Digital + Aux IN - Headphone OUT Aux IN - Digital OUT	3.80	8.00	mA

Table 12-2. Audio PATH Power Consumption

PATH_SEL	AUDIO PATH	Description	Consumption		Units
			V _{INSYS}	A _{VDD}	
10111	DAC Playback + Line Bypass and Line Record	Digital + Line IN - Headphone OUT Line IN - Digital OUT	3.80	8.00	mA
11000	DAC Playback + Mic Sidetone + Aux Bypass and Mic + Aux Record	Digital + Mic + Aux IN - Headphone OUT Mic + Aux IN - Digital OUT	3.80	8.25	mA
11001	DAC Playback + Mic Sidetone + Line Bypass and Mic + Line Record	Digital + Mic + Line IN - Headphone OUT Mic + Line IN - Digital OUT	3.80	8.25	mA

12.6 Digital Audio Interface

12.6.1 General Description

AT73C246 features a 16 to 24-bit multi-mode master / slave I²S port. The following modes are provided:

- I2S,
- Left Justified,
- Right Justified, and
- SSC

The I²S port is configured through register I2S_CONTROL (0x13) and FRAME_CONTROL (0x14). For each of the listed modes, the data transfer is described in the following sections.

The following table provides authorized MCLK / FS ratios and associated filter types:

Table 12-3. Authorized MCLK / FS Ratios & Filter Types

	12 MHz ⁽¹⁾	12.288 MHz	18.432 MHz	11.2896 MHz	16.9344 MHz
8 KHz	0	2	2	NA	NA
16 KHz	0	2	2	NA	NA
32 KHz	0	2	2	NA	NA
48 KHz	3	1	1	NA	NA
96 KHz	4	3	3	NA	NA
22.05 KHz	1	NA	NA	1	1
44.1 KHz	1	NA	NA	1	1
88.2 KHz	3	NA	NA	3	3

Note: 1. 12.0000 MHz case is not provided if DAI is configured in Right-Justified and Master mode in DAI_CONTROL (0x13) and FRAME_CONTROL registers (0x14).

12.6.2 Data Transfer: I²S MODE

Figure 12-7. N-bit I²S Mode (FS = 44.1KHz - MCLK = 256 x FS)

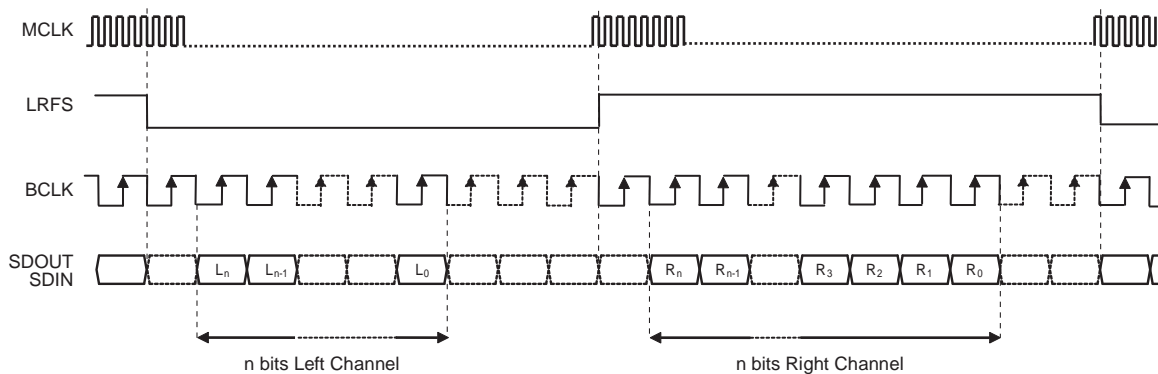

12.6.3 Data Transfer: Left Justified Mode

Figure 12-8. N-bit Left Justified Mode (FS = 44.1KHz - MCLK = 256 x FS)

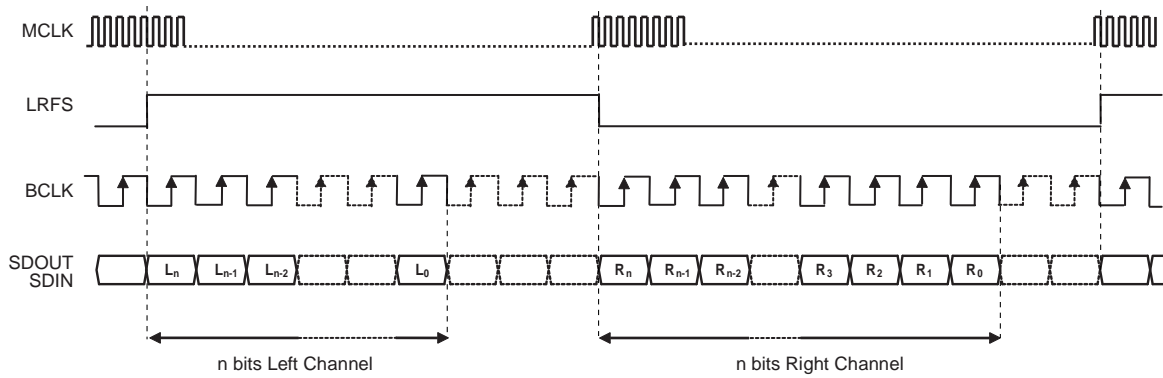

12.6.4 Data Transfer: Right Justified Mode

Figure 12-9. N-bit Right Justified Mode (FS = 44.1KHz - MCLK = 256 x FS)

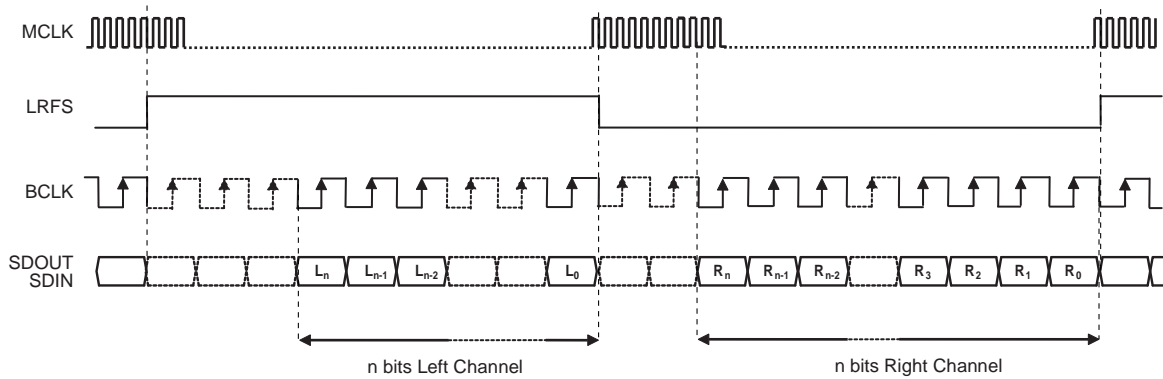

12.6.5 Timing Specifications

Figure 12-10. Timing Diagram of data interface (I²S Mode)

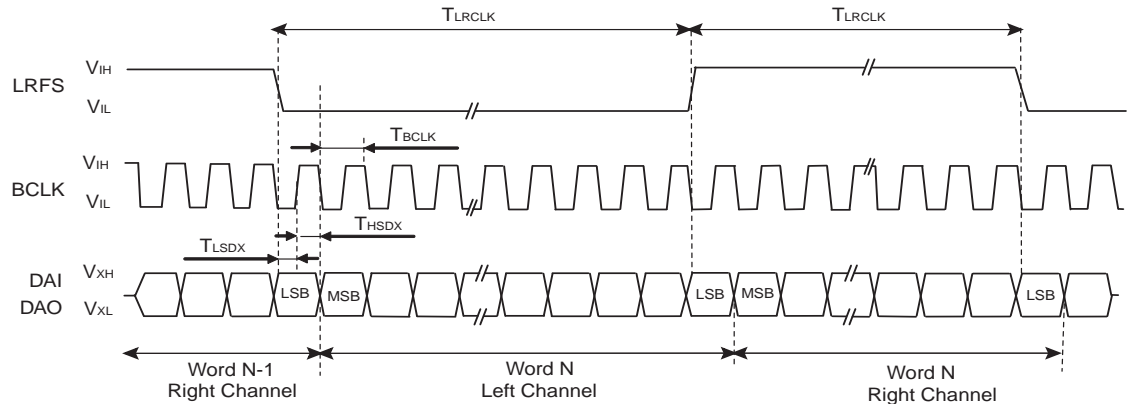

Table 12-4. Digital Audio Interface Timing Specifications

Parameter	Symbols	Min	Typ	Max	Unit
Left/Right Word Cycle Time	T_{LRCLK}		$1 / (2 \times F_S)$		s
Bit Clock Period	T_{BCLK}	$T_{MCLK} / 2$			s
BCLK Posedge to {DAI, DAO and LRFS} Change Hold Time	T_{HSDX}	5			ns
{DAI, DAO and LRFS} Change to BCLK Posedge Setup Time	T_{LSDX}	5			ns

12.7 Digital Filters Transfer Function

12.7.1 DAC Frequency Response

The following diagrams are referred to $F_S = 1$ (Sampling Frequency).

Figure 12-11. DAC Type 0 Frequency Response

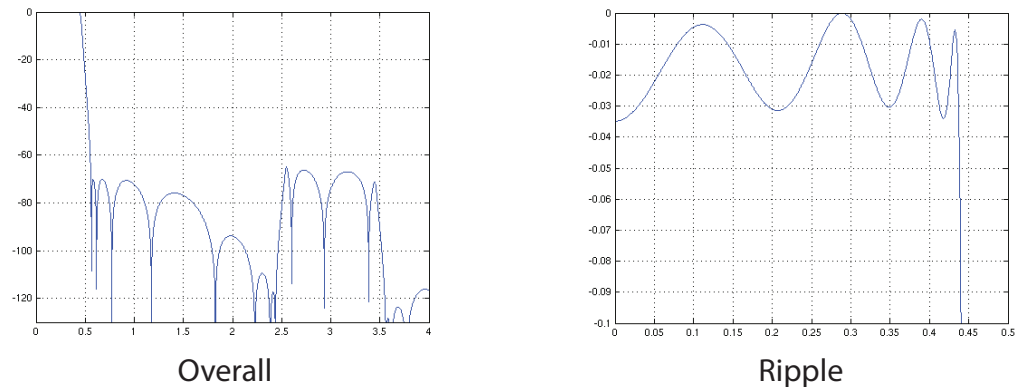
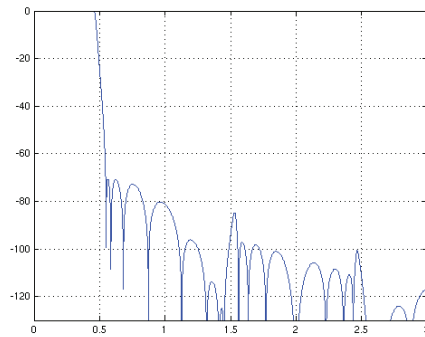
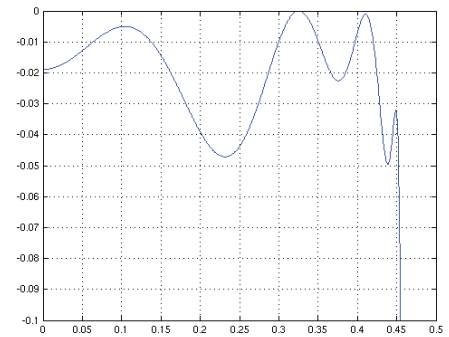

Figure 12-12. DAC Type 1 Frequency Response



Overall



Ripple

Figure 12-13. DAC Type 2 Frequency Response

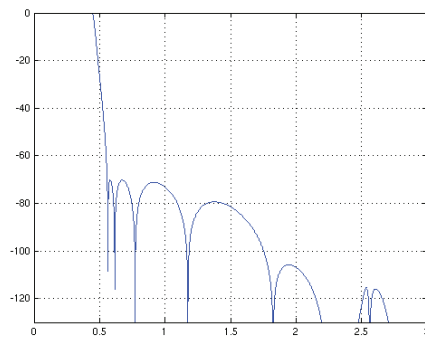

Overall

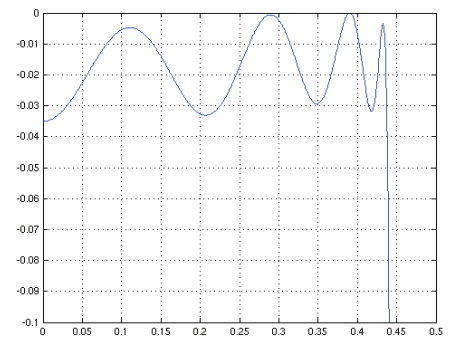

Ripple

Figure 12-14. DAC Type 3 Frequency Response

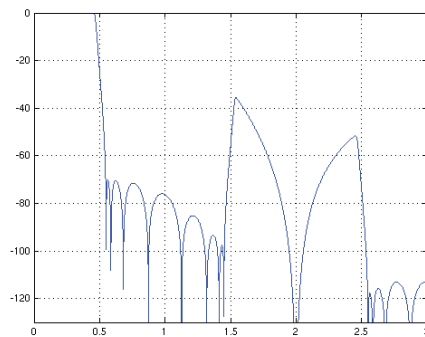

Overall

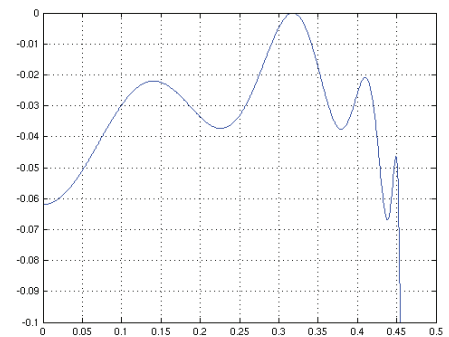

Ripple

Figure 12-15. DAC Type 4 Frequency Response

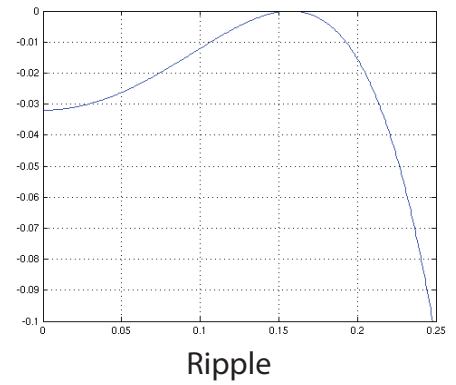
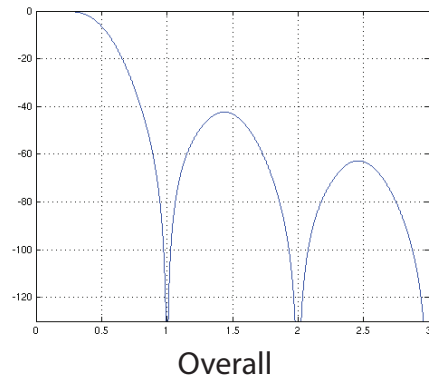

12.7.2 ADC Frequency Response

The following diagrams are referred to FS = 1 (Sampling Frequency).

Figure 12-16. ADC Type 0 Frequency Response

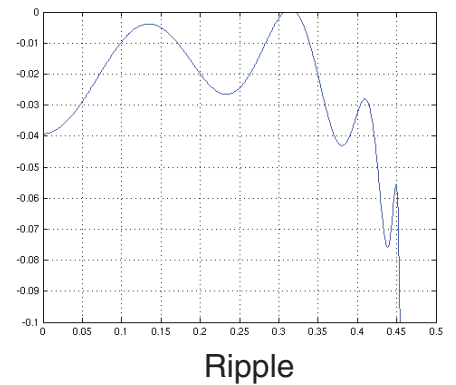
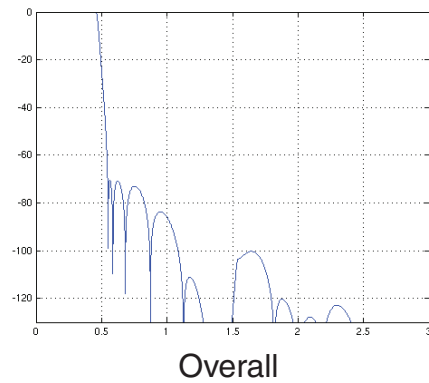

Figure 12-17. ADC Type 1 Frequency Response

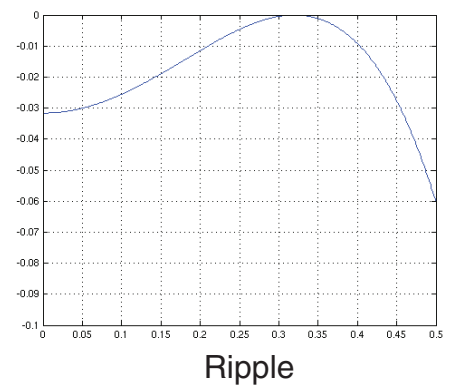
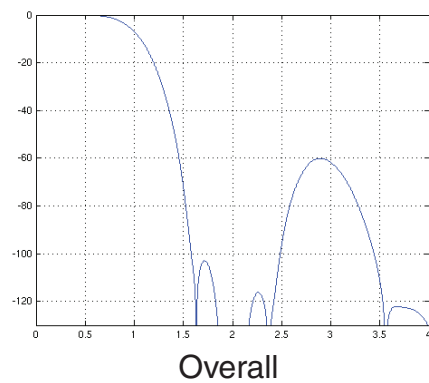

Figure 12-18. ADC Type 2 Frequency Response

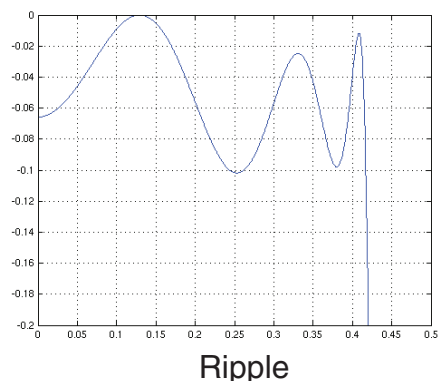
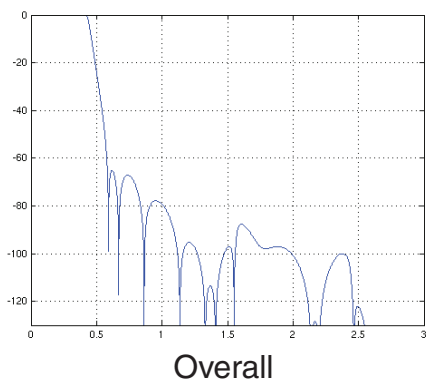

Figure 12-19. ADC Type 3 Frequency Response

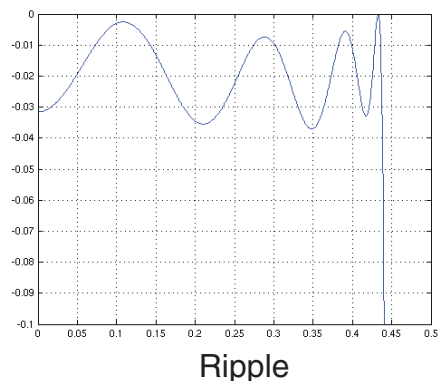
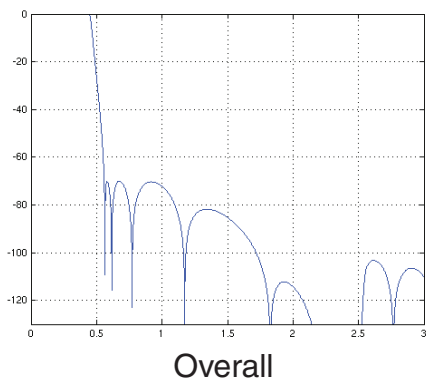
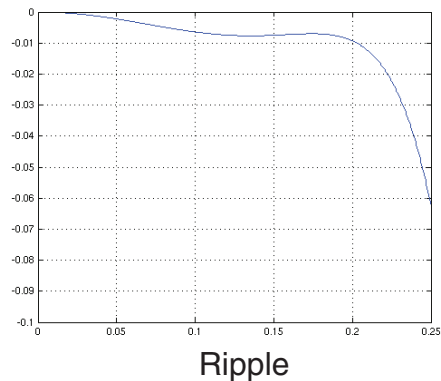
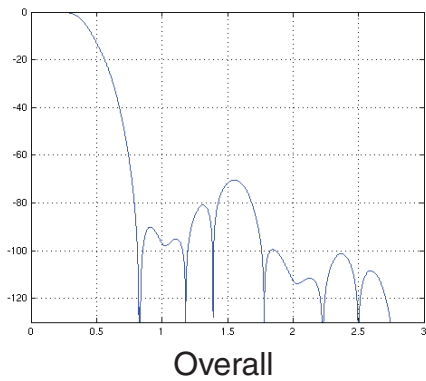

Figure 12-20. ADC Type 4 Frequency Response



12.7.3 De-Emphasis Filter Frequency Response

12.7.3.1 De-Emphasis Filter: Frequency Response & Error (FS = 32kHz)

Figure 12-21. De-Emphasis Filter: Frequency Response & Error (FS = 32kHz)

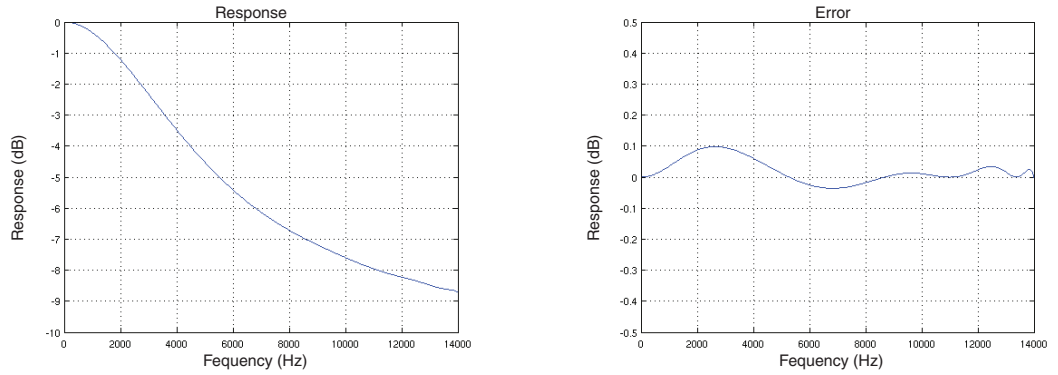

12.7.3.2 De-Emphasis Filter: Frequency Response & Error (FS = 44.1kHz)

Figure 12-22. De-Emphasis Filter: Frequency Response & Error (FS = 44.1kHz)

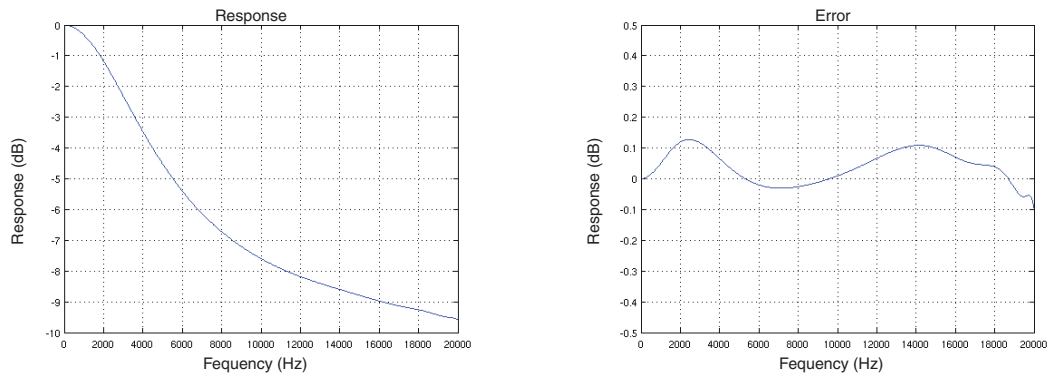

12.7.3.3 De-Emphasis Filter: Frequency Response & Error (FS = 48kHz)

Figure 12-23. De-Emphasis Filter: Frequency Response & Error (FS = 48kHz)

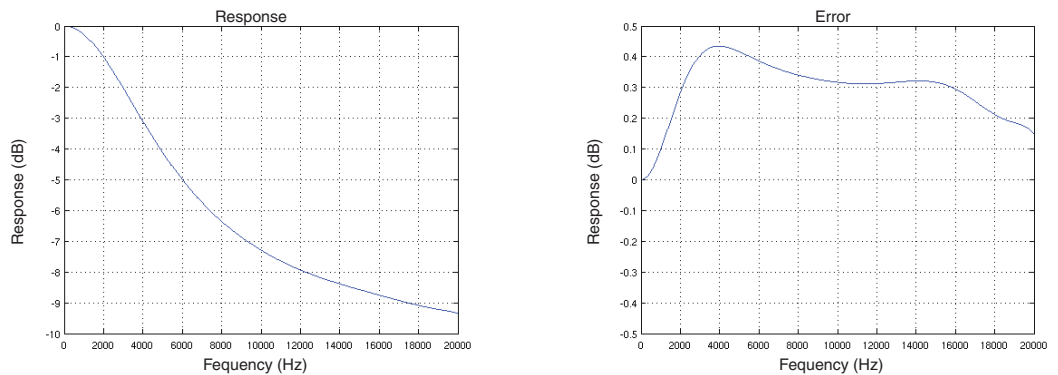

12.7.4 Equalizer Frequency Response

The following figures show the frequency response of the equalizer function implemented in the D/A channels.

Figure 12-24. Bass Filters Response

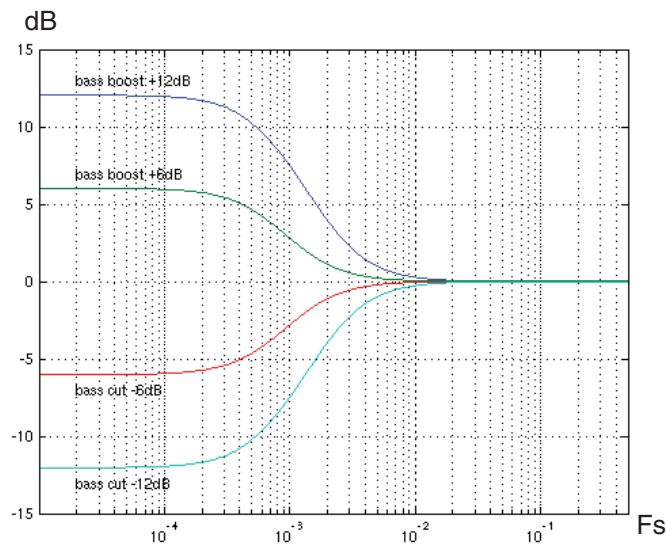

Figure 12-25. Medium Filters Response

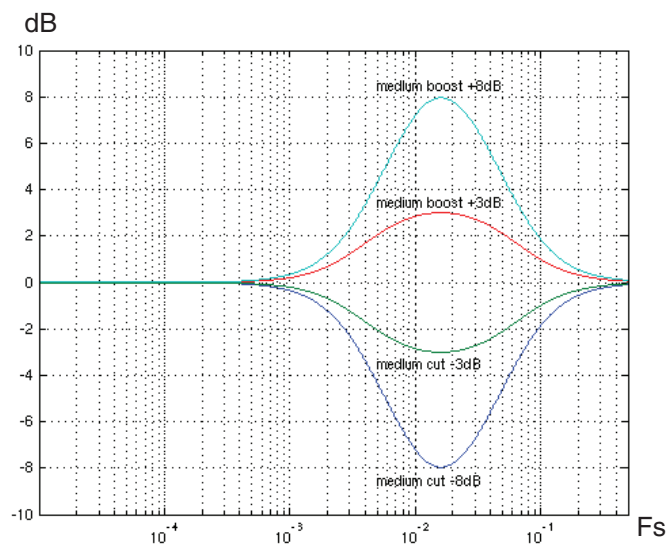
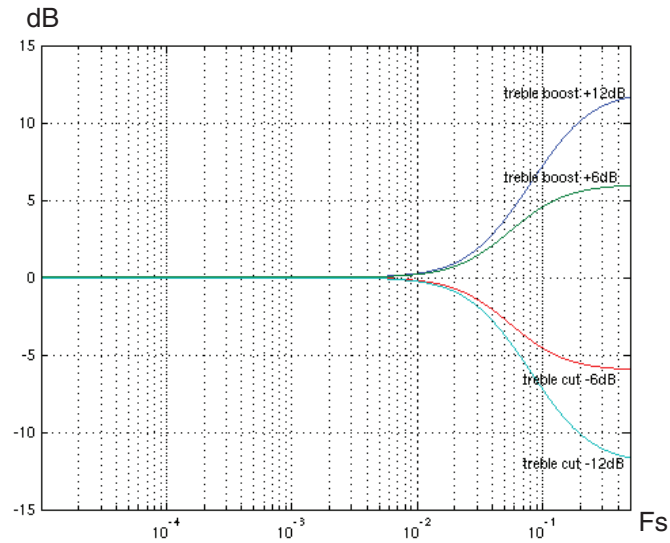

Figure 12-26. Treble Filters Response



12.8 Analog Audio Interfaces

12.8.1 Microphone Inputs

The following figures show recommended application circuits for microphone inputs configurations:

- Mono - single-ended and differential microphone
- Stereo - single ended and differential microphone
- Long-wires microphone

Recommended resistor / capacitor / inductor value may be tuned to the final application, depending on:

- the microphone specified load resistance,
- the high pass filter desired corner frequency,
- the level and frequency of unwanted signals to be rejected.

Depending also on desired high frequency filtering: common-mode or differential, the differential suggested application diagrams may be modified.

Figure 12-27. Mono - Single Ended and Differential Microphone Applications

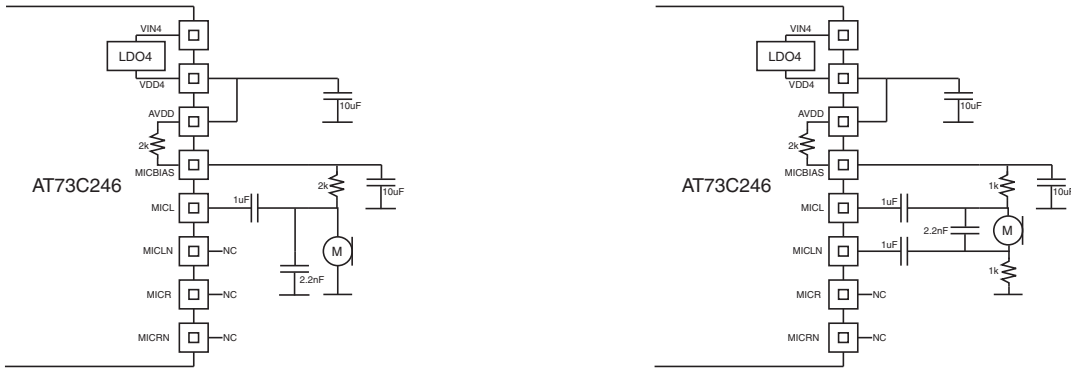

Figure 12-28. Stereo - Single Ended and Differential Microphone Applications

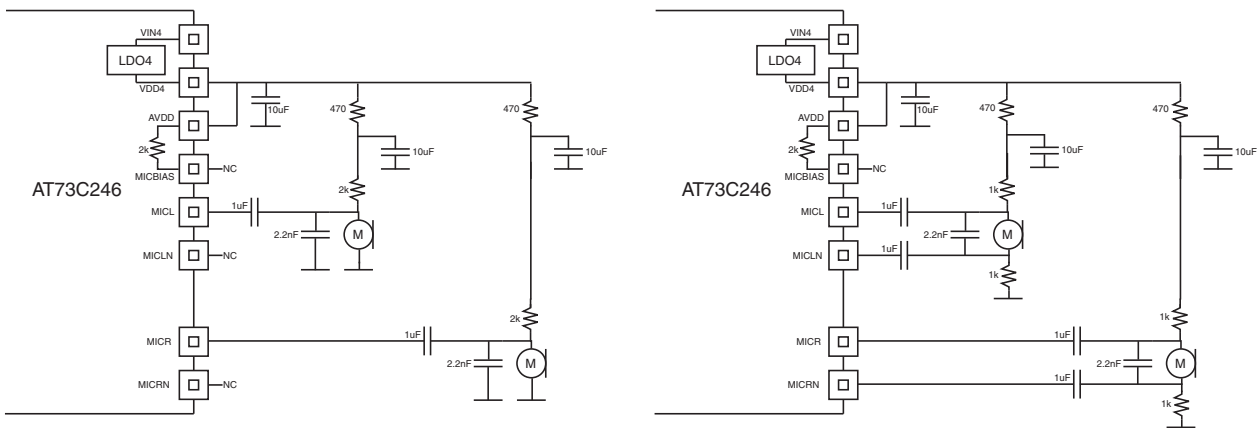
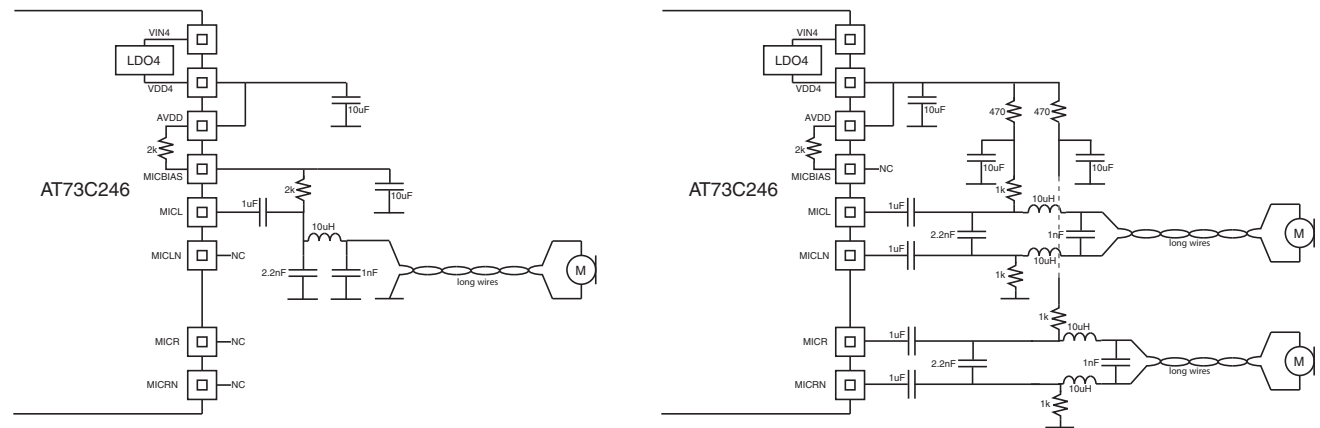
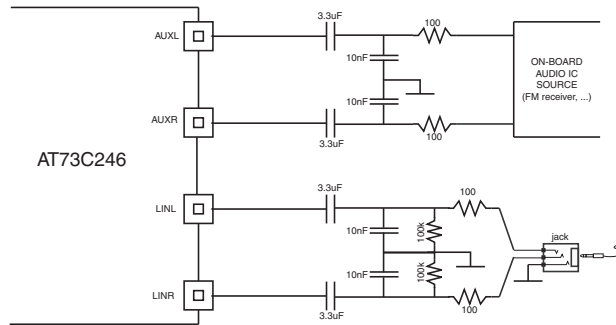

Figure 12-29. Long Wires Microphone Applications



12.8.2 Aux / Line Inputs

Figure 12-30. Aux and Line Input Application Circuits



12.8.3 Line / Headphone Outputs

Figure 12-31. AC Coupled Output Application Circuits

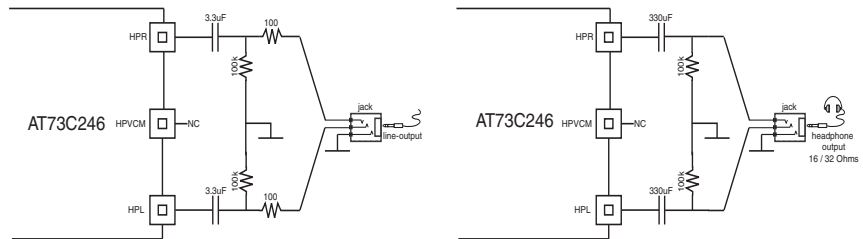
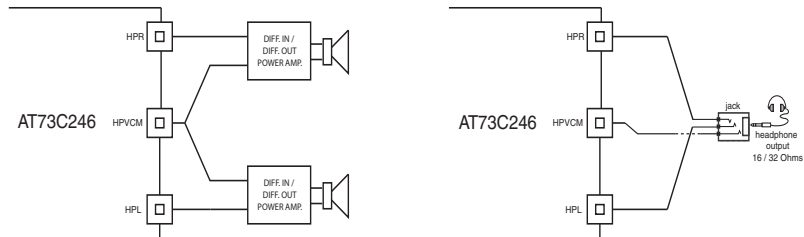

Figure 12-32. DC Coupled (CAPLESS) Application Circuits



13. Two Wire Interface and Control Registers

13.1 Two-wire Interface (TWI) Protocol

The two-wire interface interconnects components on a unique two-wire bus, made up of one clock line and one data line with speeds up to 400 Kbits per second, based on a byte oriented transfer format. The TWI is slave only and single byte access.

The interface adds flexibility to the power supply solution, enabling LDO regulators to be controlled depending on the instantaneous application requirements.

The AT73C246 has the following 7-bit address:1001001.

Attempting to read data from register addresses not listed in this section results in 0xFF being read out.

- TWCK is an input pin for the clock
- TWD is an open-drain pin that drives or receives the serial data

The data put on the TWD line must be 8 bits long. Data is transferred MSB first. Each byte must be followed by an acknowledgement.

Each transfer begins with a START condition and terminates with a STOP condition.

- A high-to-low transition on TWD while TWCK is high defines a START condition.
- A low-to-high transition on TWD while TWCK is high defines a STOP condition.

Figure 13-1. TWI Start/Stop Cycle

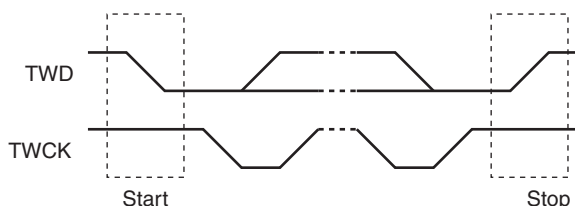
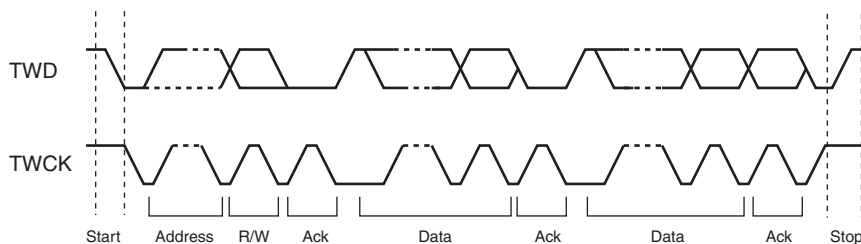

Figure 13-2. TWI Data Cycle



After the host initiates a Start condition, it sends the 7-bit slave address defined above to notify the slave device. A Read/Write bit follows (Read = 1, Write = 0).

The device acknowledges each received byte.

The first byte sent after device address and R/W bit is the address of the device register the host wants to read or write.

For a write operation the data follows the internal address

For a read operation a repeated Start condition needs to be generated followed by a read on the device.

Figure 13-3. TWD Write Operation

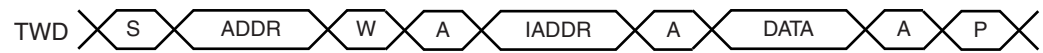
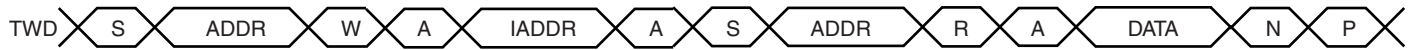

Figure 13-4. TWD Read Operation



- S = Start
- P = Stop
- W = Write
- R = Read
- A = Acknowledge
- N = Not Acknowledge
- ADDR = Device address
- IADDR = Internal address

13.2 PMU Register Tables

13.2.1 Register Mapping

Table 13-1. Register Mapping

Addr	Name	7	6	5	4	3	2	1	0
0x00	PMU_MODES	-	-	-	-	-	STANDBY	PWRDOWN	RUN
0x01	PMU_WAKEUP_EVENTS	-	-	RTC	PWREN	WAKEUP3	WAKEUP2	WAKEUP1	WAKEUP0
0x02	PMU_WAKEUP_TRIG	-	-	RTCR	PWREN	WAKEUP3	WAKEUP2	WAKEUP1	WAKEUP0
0x03	PMU_STANDBY_SUPPLIES	-	-	LP_VDD1	LP_VDD0	VDD3	VDD2	VDD1	VDD0
0x04	PMU_SUPPLY_CTRL	-	-	IN_PHASE	DVS_VDD4	DVS_VDD3	DVS_VDD2	DVS_VDD1	DVS_VDD0
0x05	PMU_RST_LEVEL	RST_VDD3		RST_VDD2		RST_VDD1		RST_VDD0	
0x06	VDD0_CTRL	ON_VDD0	LPMODE	VDD0_SEL					
0x07	VDD1_CTRL	ON_VDD1	LPMODE	VDD1_SEL					
0x08	VDD2_CTRL	ON_VDD2	-	-	VDD2_SEL				
0x09	VDD3_CTRL	ON_VDD3	-	-	VDD3_SEL				
0x0A	VDD4_CTRL	ON_VDD4	-	-	VDD4_SEL				
0x0B	PMU_LED	TON_LED			PERIOD_LED			BLINK	ON_LED
0x0C	PMU_MASK	-	-	-	-	-	-	RTC_ALARM	RTC_IT
0x0D	PMU_IT	-	-	-	-	-	-	RTC_ALARM	RTC_IT
0x0E	PMU_WAKEUP_SUPPLIES	-	-	-	-	VDD0_WUP	VDD1_WUP	VDD2_WUP	VDD3_WUP
0x10	AUTOSTART	-	ENAC	STANDBY	PATH_SEL				
0x11	AUDIO_CONTROL	-	BCLKINV	DCBLOCK	ENCONF	CUSTCONF	ENASR	ASR_TIME	
0x12	MIC_CONTROL	-	-	MICLDIFF	MICRDIFF	MICDET		ONMICBIAS	MICDET_ST
0x13	DAI_CONTROL	-	-	-	-	MASTER	MCLKSEL		
0x14	FRAME_CONTROL	SSCMODE	WL		DAIMODE		SELFS		
0x15	MUTE	MUTEDACL	MUTEDACR	MUTEINL	MUTEINR	MUTEMICL	MUTEMICR	MUTEHPL	MUTEHPR
0x16	MICLVOL	-	-	MICLVOL					
0x17	MICRVOL	-	-	MICRVOL					
0x18	INLVOL	INLBOTH	INLVOL						
0x19	INRVOL	INRBOTH	INRVOL						
0x1A	HPLVOL	HPLVOL							
0x1B	HPRVOL	HPRVOL							
0x1C	HP_CONTROL	-	-	-	-	-	HPDET_ST	LHPBOTH	RHPBOTH
0x1D	AUDIO_EFFECTS	3DFX_DEPTH		ON3DFX	SWAP_DAC	SWAP_ADC	MONO_DAC	MONO_ADC	ONDEEMP
0x1E	INPUT_CONTROL	-	LINESEL	ONMICL	ONMICR	ONADCL	ONADCR	ONLINL	ONLINR
0x1F	OUTPUT_CONTROL	-	ONSIDETONE	ONPLAYBACK	ONBYPASS	ONHPL	ONHPR	ONDAACL	ONDACR
0x20	INPUT_MIXER	-	-	MIXMICL	MIXMICR	MIXLINEL	MIXLINER	ONMIXL	ONMIXR
0x21	SIDETONE_VOL	-	-	-	SIDETONE_VOL				
0x22	EQUALIZER	-	-	-	-	EQ_SEL			
0x30	ADC_CTRL	ON_ADC	ON_BUF	TS					
0x31	ADC_MUX_1	-	VIN	-	VDD4	VDD3	VDD2	VDD1	VDD0
0x32	ADC_MUX_2	-	-	-	-	ANA3	ANA2	ANA1	ANA0
0x33	ADC_ANA0_MSB	ADC<9:2>							

Table 13-1. Register Mapping

Addr	Name	7	6	5	4	3	2	1	0	
0x34	ADC_ANA0_LSB	-	-	-	-	-	-	ADC<1:0>		
0x35	ADC_ANA1_MSB	ADC<9:2>								
0x36	ADC_ANA1_LSB	-	-	-	-	-	-	ADC<1:0>		
0x37	ADC_ANA2_MSB	ADC<9:2>								
0x38	ADC_ANA2_LSB	-	-	-	-	-	-	ADC<1:0>		
0x39	ADC_ANA3_MSB	ADC<9:2>								
0x3A	ADC_ANA3_LSB	-	-	-	-	-	-	ADC<1:0>		
0x3B	ADC_VDD0_MSB	ADC<9:2>								
0x3C	ADC_VDD0_LSB	-	-	-	-	-	-	ADC<1:0>		
0x3D	ADC_VDD1_MSB	ADC<9:2>								
0x3E	ADC_VDD1_LSB	-	-	-	-	-	-	ADC<1:0>		
0x3F	ADC_VDD2_MSB	ADC<9:2>								
0x40	ADC_VDD2_LSB	-	-	-	-	-	-	ADC<1:0>		
0x41	ADC_VDD3_MSB	ADC<9:2>								
0x42	ADC_VDD3_LSB	-	-	-	-	-	-	ADC<1:0>		
0x43	ADC_VDD4_MSB	ADC<9:2>								
0x44	ADC_VDD4_LSB	-	-	-	-	-	-	ADC<1:0>		
0x47	ADC_VIN_MSB	ADC<9:2>								
0x48	ADC_VIN_LSB	-	-	-	-	-	-	ADC<1:0>		
0x49	ADC_ANA_LSB	ADC_ANA3<1:0>		ADC_ANA2<1:0>		ADC_ANA1<1:0>		ADC_ANA0<1:0>		
0x50	RTC_CTRL	-	-	-	-	-	RTC_WRITE	RTC_SEL	RTC_EN	
0x51	RTC_ADDR	RTC_ADDR								
0x52	RTC_DATA0	RTC_DATA0								
0x53	RTC_DATA1	RTC_DATA1								
0x54	RTC_DATA2	RTC_DATA2								
0x55	RTC_DATA3	RTC_DATA3								
0x56	BACKUP_CTRL	-	-	-	-	OSC_UPDT	OSC_EN	OSC_STAT	RST_BKUP	
0x7F	VERSION	SOFTWARE_TAG				VERSION				

13.2.2 PMU Control

Name: PMU_MODES

Access: Read / Write

Address: 0x00

7	6	5	4	3	2	1	0
-	-	-	-	-	STANDBY	PWRDOWN	RUN

Table 13-2. PMU_MODES (0x00) Structure

Bit	Name	Description	Reset value
7:3	-	unused	00000
2	STANDBY	STANDBY request 0: Default value. 1: STANDBY request. Reset to 0 at STANDBY exit.	0
1	PWRDOWN	POWERDOWN request 0: Default value. 1: POWERDOWN request. Reset to 0 when POWERDOWN state reached.	0
0	RUN	RUN mode	0

- Notes:
1. Please refer to [Section 11. "PMU Functional Description" on page 25](#)
 2. 'RUN' bit is read-only. Only 'STANDBY' and 'PWRDOWN' bits can be written

Name: PMU_WAKEUP_EVENTS

Access: Read / Write

Address: 0x01

7	6	5	4	3	2	1	0
-	-	RTC	PWREN	WAKEUP3	WAKEUP2	WAKEUP1	WAKEUP0

Table 13-3. PMU_WAKEUP_EVENTS (0x01) Structure

Bit	Name	Description	Reset value
7:6	-	unused	00
5	RTC	Wake up by RTC alarm input 0: disabled 1: enabled	0
4	PWREN	Wake up by PWREN input 0: disabled 1: enabled	0
3	WAKEUP3	Wake up by WAKEUP3 input 0: disabled 1: enabled	0
2	WAKEUP2	Wake up by WAKEUP2 input 0: disabled 1: enabled	0
1	WAKEUP1	Wake up by WAKEUP1 input 0: disabled 1: enabled	0
0	WAKEUP0	Wake up by WAKEUP0 input 0: disabled 1: enabled	1

Note: Please refer to [Section 11. "PMU Functional Description" on page 25](#)

Name: PMU_WAKEUP_TRIG

Access: Read Only

Address: 0x02

7	6	5	4	3	2	1	0
-	-	RTCR	PWREN	WAKEUP3	WAKEUP2	WAKEUP1	WAKEUP0

Table 13-4. PMU_WAKEUP_TRIG (0x02) Structure

Bit	Name	Description	Reset value
7:6	-	unused	00
5	RTCR	WAKEUP_EVENT triggered on RTC alarm	0
4	PWREN	WAKEUP_EVENT triggered on PWREN	0
3	WAKEUP3	WAKEUP_EVENT triggered on WAKEUP3	0
2	WAKEUP2	WAKEUP_EVENT triggered on WAKEUP2	0
1	WAKEUP1	WAKEUP_EVENT triggered on WAKEUP1	0
0	WAKEUP0	WAKEUP_EVENT triggered on WAKEUP0	0

Note: Please refer to [Section 11. "PMU Functional Description" on page 25](#)

Name: PMU_STANDBY_SUPPLIES

Access: Read / Write

Address: 0x03

7	6	5	4	3	2	1	0
-	-	LP_VDD1	LP_VDD0	VDD3	VDD2	VDD1	VDD0

Table 13-5. PMU_STANDBY_SUPPLIES (0x03) Structure

Bit	Name	Description	Reset value
7:6	-	unused	00
5	LP_VDD1	VDD1 Low power mode in STANDBY 0: Full power (PWM) 1: Low power (PFM)	1
4	LP_VDD0	VDD0 Low power mode in STANDBY 0: Full power (PWM) 1: Low power (PFM)	1
3	VDD3	VDD3 in STANDBY state 0: OFF 1: ON	1
2	VDD2	VDD2 in STANDBY state 0: OFF 1: ON	0
1	VDD1	VDD1 in STANDBY state 0: OFF 1: ON	0
0	VDD0	VDD0 in STANDBY state 0: OFF 1: ON	1

Name: PMU_SUPPLY_CTRL

Access: Read / Write

Address: 0x04

7	6	5	4	3	2	1	0
-	-	IN_PHASE	DVS_VDD4	DVS_VDD3	DVS_VDD2	DVS_VDD1	DVS_VDD0

Table 13-6. PMU_SUPPLY_CTRL (0x04) Structure

Bit	Name	Description	Reset value
7:6	-	unused	00
5	IN_PHASE	DCDC0 and DCDC1 phase operation 0: out-of phase 1: in-phase	0
4	DVS_VDD4	DVS function on VDD4 0: OFF 1: ON	1
3	DVS_VDD3	DVS function on VDD3 0: OFF 1: ON	1
2	DVS_VDD2	DVS function on VDD2 0: OFF 1: ON	1
1	DVS_VDD1	DVS function on VDD1 0: OFF 1: ON	1
0	DVS_VDD0	DVS function on VDD0 0: OFF 1: ON	1

Name: PMU_RST_LVL

Access: Read / Write

Address: 0x05

7	6	5	4	3	2	1	0
RST_VDD3		RST_VDD2		RST_VDD1		RST_VDD0	

Table 13-7. PMU_RST_LVL (0x05) Structure

Bit	Name	Description	Reset value
7:6	RST_VDD3	RST level on VDD3	01
5:4	RST_VDD2	RST level on VDD2	10
3:2	RST_VDD1	RST level on VDD1	10
1:0	RST_VDD0	RST level on VDD0	11

Table 13-8. VDDx Reset Level Selection Table

RST_VDDx	RST LEVEL
00	0.85 x VDDx
01	0.90 x VDDx
10	0.92 x VDDx
11	0.95 x VDDx

Name: VDD0_CTRL

Access: Read / Write

Address: 0x06

7	6	5	4	3	2	1	0
ON_VDD0	LPMODE	VDD0_SEL					

Table 13-9. VDD0_CTRL (0x06) Structure

Bit	Name	Description	Reset value
7	ON_VDD0	VDD0 ON/OFF 0: OFF 1: ON	0
6	LPMODE	VDD0 Low power mode 0: Full power (PWM) 1: Low power (PFM)	0
5:0	VDD0_SEL	VDD0 voltage selection	010101

Table 13-10. VDD0 Voltage Selection Table

VDD0_SEL	VDD0 (V)	VDD0_SEL	VDD0 (V)	VDD0_SEL	VDD0 (V)
000000	0.80	010011	1.75	100110	2.70
000001	0.85	010100	1.80	100111	2.75
000010	0.90	010101	1.85	101000	2.80
000011	0.95	010110	1.90	101001	2.85
000100	1.00	010111	1.95	101010	2.90
000101	1.05	011000	2.00	101011	2.95
000110	1.10	011001	2.05	101100	3.00
000111	1.15	011010	2.10	101101	3.05
001000	1.20	011011	2.15	101110	3.10
001001	1.25	011100	2.20	101111	3.15
001010	1.30	011101	2.25	110000	3.20
001011	1.35	011110	2.30	110001	3.25
001100	1.40	011111	2.35	110010	3.30
001101	1.45	100000	2.40	110011	3.35
001110	1.50	100001	2.45	110100	3.40
001111	1.55	100010	2.50	110101	3.45
010000	1.60	100011	2.55	110110	3.50
010001	1.65	100100	2.60	110111	3.55
010010	1.70	100101	2.65	111000	3.60

Name: VDD1_CTRL

Access: Read / Write

Address: 0x07

7	6	5	4	3	2	1	0
ON_VDD1	LPMODE	VDD1_SEL					

Table 13-11. VDD1_CTRL (0x07) Structure

Bit	Name	Description	Reset value
7	ON_VDD1	VDD1 ON / OFF 0: OFF 1: ON	0
6	LPMODE	VDD1 Low power mode 0: Full power (PWM) 1: Low power (PFM)	0
5:0	VDD1_SEL	VDD1 voltage selection	001000

Table 13-12. VDD1 Voltage Selection Table

VDD1_SEL	VDD1 (V)	VDD1_SEL	VDD1 (V)	VDD1_SEL	VDD1 (V)
000000	0.80	010011	1.75	100110	2.70
000001	0.85	010100	1.80	100111	2.75
000010	0.90	010101	1.85	101000	2.80
000011	0.95	010110	1.90	101001	2.85
000100	1.00	010111	1.95	101010	2.90
000101	1.05	011000	2.00	101011	2.95
000110	1.10	011001	2.05	101100	3.00
000111	1.15	011010	2.10	101101	3.05
001000	1.20	011011	2.15	101110	3.10
001001	1.25	011100	2.20	101111	3.15
001010	1.30	011101	2.25	110000	3.20
001011	1.35	011110	2.30	110001	3.25
001100	1.40	011111	2.35	110010	3.30
001101	1.45	100000	2.40	110011	3.35
001110	1.50	100001	2.45	110100	3.40
001111	1.55	100010	2.50	110101	3.45
010000	1.60	100011	2.55	110110	3.50
010001	1.65	100100	2.60	110111	3.55
010010	1.70	100101	2.65	111000	3.60

Name: VDD2_CTRL

Access: Read / Write

Address: 0x08

7	6	5	4	3	2	1	0
ON_VDD2	-	-	VDD2_SEL				

Table 13-13. VDD2_CTRL (0x08) Structure

Bit	Name	Description	Reset value
7	ON_VDD2	VDD2 ON / OFF 0: OFF 1: ON	0
6:5	-	unused	00
4:0	VDD2_SEL	VDD2 voltage selection	00100

Table 13-14. VDD2 Voltage Selection Table

VDD2_SEL	VDD2 (V)
00000	0.80
00001	0.85
00010	0.90
00011	0.95
00100	1.00
00101	1.05
00110	1.10
00111	1.15
01000	1.20
01001	1.25
01010	1.30
01011	1.35

Name: VDD3_CTRL

Access: Read / Write

Address: 0x09

7	6	5	4	3	2	1	0
ON_VDD3	-	-	VDD3_SEL				

Table 13-15. VDD3_CTRL (0x09) Structure

Bit	Name	Description	Reset value
7	ON_VDD3	VDD3 ON / OFF 0: OFF 1: ON	0
6:5	-	unused	00
4:0	VDD3_SEL	VDD3 voltage selection	01100

Table 13-16. VDD3 Voltage Selection Table

VDD3_SEL	VDD3 (V)
00000	2.70
00001	2.75
00010	2.80
00011	2.85
00100	2.90
00101	2.95
00110	3.00
00111	3.05
01000	3.10
01001	3.15
01010	3.20
01011	3.25
01100	3.30
01101	3.35
01110	3.40
01111	3.45
10000	3.50
10001	3.55
10010	3.60

Name: VDD4_CTRL

Access: Read / Write

Address: 0x0A

7	6	5	4	3	2	1	0
ON_VDD4	-	-	VDD4_SEL				

Table 13-17. VDD4_CTRL (0x0A) Structure

Bit	Name	Description	Reset value
7	ON_VDD4	VDD4 ON / OFF 0: OFF 1: ON	0
6:5	-	unused	00
4:0	VDD4_SEL	VDD4 voltage selection	01100

Table 13-18. VDD4 Voltage Selection Table

VDD4_SEL	VDD4 (V)
00000	2.70
00001	2.75
00010	2.80
00011	2.85
00100	2.90
00101	2.95
00110	3.00
00111	3.05
01000	3.10
01001	3.15
01010	3.20
01011	3.25
01100	3.30
01101	3.35
01110	3.40
01111	3.45
10000	3.50
10001	3.55
10010	3.60

Name: PMU_LED
Access: Read / Write
Address: 0x0B

7	6	5	4	3	2	1	0
TON_LED			PERIOD_LED			BLINK	ON_LED

Table 13-19. PMU_LED (0x0B) Structure

Bit	Name	Description	Reset value
7:5	TON_LED	LED 'ON' time	000
4:2	PERIOD_LED	LED blinking period	010
1	BLINK	Blinking function ON / OFF 0: OFF 1: ON	0
0	ON_LED	Led ON / OFF 0: OFF 1: ON	0

Table 13-20. LED Blinking Function Parameters Selection Table

TON_LED	LED 'ON' Time (ms)	PERIOD_LED	BLINKING PERIOD (s)
000	25	000	0.5
001	50	001	1
010	75	010	2
011	100	011	3
100	125	100	4
101	150	101	5
110	175	110	6
111	200	111	8

Note: In case of TON_LED = 175ms, PERIOD_LED=5s and BLINK=1 selection, the LED pin is driven according to the following diagram. During 9 clock periods (internal RC 32kHz oscillator) the pin is driven to 0, and during 1 clock period the pin is configured as 'input' with an internal pull up resistor to VINSYS.

Figure 13-5. LED Pin Timing Diagram for TON_LED = 175ms and PERIOD_LED=5s

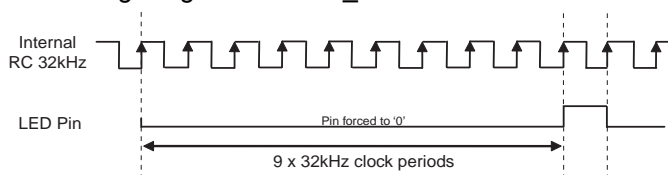

Name: PMU_MASK

Access: Read / Write

Address: 0x0C

7	6	5	4	3	2	1	0
-	-	-	-	-	-	RTC_ALA RM	RTC_IT

Table 13-21. PMU_MASK (0x0C) Structure

Bit	Name	Description	Reset value
7:2	-	unused	111111
1	RTC_ALARM	Mask RTC alarm 0: not masked 1: masked	1
0	RTC_IT	Mask RTC interrupt 0: not masked 1: masked	1

Name: PMU_IT

Access: Read Only

Address: 0x0D

7	6	5	4	3	2	1	0
-	-	-	-	-	-	RTC_ALA RM	RTC_IT

Table 13-22. PMU_IT (0x0D) Structure

Bit	Name	Description	Reset value
7:2	-	unused	000000
1	RTC_ALARM	RTC alarm interrupt 0: default value 1: RTC alarm has occurred. Reset to 0 at read.	0
0	RTC_IT	RTC interrupt 0: default value 1: RTC interrupt has occurred. Reset to 0 at read.	0

Name: PMU_WAKEUP_SUPPLIES

Access: Read / Write

Address: 0x0E

7	6	5	4	3	2	1	0
-	-	-	-	VDD0_WUP	VDD1_WUP	VDD2_WUP	VDD3_WUP

Table 13-23. PMU_WAKEUP_SUPPLIES (0x0E) Structure

Bit	Name	Description	Reset value
7:4	-	unused	0000
3	VDD0_WUP	VDD0 Value at WAKEUP 0: Programmed value 1: Default value	1
2	VDD1_WUP	VDD1 Value at WAKEUP 0: Programmed value 1: Default value	1
1	VDD2_WUP	VDD2 Value at WAKEUP 0: Programmed value 1: Default value	1
0	VDD3_WUP	VDD3 Value at WAKEUP 0: Programmed value 1: Default value	1

Name: AUTOSTART

Access: Read / Write

Address: 0x10

7	6	5	4	3	2	1	0
-	ENAC	STANDBY	PATH_SEL				

Table 13-24. AUTOSTART (0x10) Structure

Bit	Name	Description	Reset value
7	-	unused	0
6	ENAC	Audio Codec ON / OFF 0: OFF 1: ON	0
5	STANDBY	Audio STANDBY mode ON / OFF 0: Audio codec active 1: Audio codec in standby	1
4:0	PATH_SEL	Audio PATH selection	00000

Table 13-25. Audio Path Selection Table

PATH_SEL	AUDIO PATH	
00000	No Path	
00001	DAC Playback	Digital IN - Headphone OUT
00010	Mic Sidetone	Microphone IN - Headphone OUT
00011	Aux Bypass	Aux IN - Headphone OUT
00100	Line Bypass	Line IN - Headphone OUT
00101	Mic Record	Mic IN - Digital OUT
00110	Aux Record	Aux IN - Digital OUT
00111	Line Record	Line IN - DIGITAL OUT
01000	Mic Sidetone + Record	Mic IN - Headphone and Digital OUT
01001	Aux Bypass + Record	Aux IN - Headphone and Digital OUT
01010	Line Bypass + Record	Line IN - Headphone and Digital OUT
01011	Mic + Aux Record	Mic + Aux IN - Digital OUT
01100	Mic + Line Record	Mic + Line IN - Digital OUT
01101	DAC Playback + Mic Sidetone	Digital + Mic IN - Headphone OUT
01110	DAC Playback + Aux Bypass	Digital + Aux IN - Headphone OUT
01111	DAC Playback + Line Bypass	Digital + Line IN - Headphone OUT
10000	DAC Playback + Mic Sidetone + Aux Bypass	Digital + Mic + Aux IN - Headphone OUT
10001	DAC Playback + Mic Sidetone + Line Bypass	Digital + Mic + Line IN - Headphone OUT
10010	DAC Playback and MIC Record	Digital IN - Headphone OUT Mic IN - Digital OUT

Table 13-25. Audio Path Selection Table

PATH_SEL	AUDIO PATH	
10011	DAC Playback and Aux Record	Digital IN - Headphone OUT Aux IN - Digital OUT
10100	DAC Playback and Line Record	Digital IN - Headphone OUT Line IN - Digital OUT
10101	DAC Playback + Mic Sidetone and Mic Record	Digital + Mic IN - Headphone OUT Mic IN - Digital OUT
10110	DAC Playback + Aux Bypass and Aux Record	Digital + Aux IN - Headphone OUT Aux IN - Digital OUT
10111	DAC Playback + Line Bypass and Line Record	Digital + Line IN - Headphone OUT Line IN - Digital OUT
11000	DAC Playback + Mic Sidetone + Aux Bypass and Mic + Aux Record	Digital + Mic + Aux IN - Headphone OUT Mic + Aux IN - Digital OUT
11001	DAC Playback + Mic Sidetone + Line Bypass and Mic + Line Record	Digital + Mic + Line IN - Headphone OUT Mic + Line IN - Digital OUT

Name: AUDIO_CONTROL

Access: Read / Write

Address: 0x11

7	6	5	4	3	2	1	0
-	BCLKINV	DCBLOCK	ENCONF	CUST_CONF	ENASR	ASR_TIME	

Table 13-26. AUDIO_CONTROL (0x11) Structure

Bit	Name	Description	Reset value
7	-	-	0
6	BLCKINV	Bit clock inversion on I ² S port 0: not inverted 1: inverted	0
5	DCBLOCK	Headphone output coupling configuration 0: DC coupled (capless operation) 1: AC coupled	0
4	ENCONF	Custom configuration enable 0: Default value. 1: custom configuration is send to audio controller.	0
3	CUST_CONF	Custom audio configuration 0: Audio path are set with PATH_SEL 1: Custom audio path set by software	0
2	ENASR	Gain soft ramping ON / OFF 0: OFF 1: ON	1
1:0	ASR_TIME	Gain soft ramping timing selection	11

Table 13-27. Gain Soft Ramping Timing Selection Table

ASR_TIME	Timing
00	MCLK / (32 x 512)
01	MCLK / (64 x 512)
10	MCLK / (128 x 512)
11	MCLK / (256 x 512)

Name: MIC_CONTROL

Access: Read / Write

Address: 0x12

7	6	5	4	3	2	1	0
-	-	MICLDIFF	MICRDIFF	MICDET		ONMICBIAS	MICDET_ST

Table 13-28. MIC_CONTROL (0x12) Structure

Bit	Name	Description	Reset value
7:6	-	unused	00
5	MICLDIFF	Left microphone differential configuration 0: Single-ended 1: Differential	0
4	MICRDIFF	Right microphone differential configuration 0: Single-ended 1: Differential	0
3:2	MICDET	Microphone detector threshold	00
1	ONMICBIAS	Microphone bias generator ON / OFF 0: OFF 1: ON	0
0	MICDET_ST	MICBIAS pin microphone detector status bit 0: No microphone detected 1: Microphone detected	0

Table 13-29. Microphone Detector Threshold Selection Table

MICDET	MICBIAS PIN LEVEL (V)
00	AVDD - 0.1
01	AVDD - 0.2
10	AVDD - 0.3
11	AVDD - 0.4

Name: DAI_CONTROL

Access: Read / Write

Address: 0x13

7	6	5	4	3	2	1	0
-	-	-	-	MASTER	MCLKSEL		

Table 13-30. DAI_CONTROL (0x13) Structure

Bit	Name	Description	Reset value
7:4	-	unused	0000
3	MASTER ⁽¹⁾	MASTER / SLAVE operation on DAI port 0: Slave 1: Master	0
2:0	MCLKSEL	Audio Master clock frequency selection	001

Note: 1. The MASTER mode is not provided for 12.0000 MHz clock case and Right-Justified mode on DAI.

Table 13-31. Audio Master Clock Selection Table

MCLKSEL	MCLK (MHz)	MCLKSEL	MCLK (MHz)
000	12.000	100	16.9344
001	12.288	101	-
010	11.2896	110	-
011	18.432	111	-

Name: FRAME_CONTROL

Access: Read / Write

Address: 0x14

7	6	5	4	3	2	1	0
SSCMODE	WL		DAI_MODE		SELFS		

Table 13-32. FRAME_CONTROL (0x14) Structure

Bit	Name	Description	Reset value
7	SSCMODE	SSC mode for DAI 0: DAI according to DAI_MODE bits 1: SSC mode	0
6:5	WL	Word length selection	11
4:3	DAI_MODE	Digital Audio Interface mode control	00
2:0	SELFS	Audio Frame frequency selection	011

Table 13-33. Digital Audio Interface Word Length Selection Table

WL	MODE
00	16
01	18
10	20
11	24

Table 13-34. Digital Audio Interface Mode Selection Table

DAIMODE	MODE
00	I2S
01	Left-Justified
10	Right-Justified ⁽¹⁾
11	N/A

Note: 1. The Right-Justified mode is not provided for 12.0000 MHz clock case and MASTER mode on DAI.

Table 13-35. Audio Sampling Frequency Selection Table

SELFS	FS (kHz)	SELFS	FS (kHz)
000	8	100	96
001	16	101	22.050
010	32	110	44.100
011	48	111	88.200

Name: MUTE
Access: Read / Write
Address: 0x15

7	6	5	4	3	2	1	0
MUTEDACL	MUTEDACR	MUTEINL	MUTEINR	MUTEMICL	MUTEMICR	MUTEHPL	MUTEHPR

Table 13-36. MUTE (0x15) Structure

Bit	Name	Description	Reset value
7	MUTEDACL	DAC Left mute 0: active 1: muted	1
6	MUTEDACR	DACR Right mute 0: active 1: muted	1
5	MUTEINL	AUX / LINE Left mute 0: active 1: muted	1
4	MUTEINR	AUX / LINE Right mute 0: active 1: muted	1
3	MUTEMICL	MIC Left mute 0: active 1: muted	1
2	MUTEMICR	MIC Right mute 0: active 1: muted	1
1	MUTEHPL	Headphone Left mute 0: active 1: muted	1
0	MUTEHPR	Headphone Right mute 0: active 1: muted	1

Name: MICLVOL
Access: Read / Write
Address: 0x16

7	6	5	4	3	2	1	0
-	-	MICLVOL					

Table 13-37. MICLVOL (0x16) Structure

Bit	Name	Description	Reset value
7:6	-	unused	00
5:0	MICLVOL	Microphone Left volume selection	000000

Table 13-38. Microphone Left Volume Selection Table

MICLVOL	GAIN(dB)	MICLVOL	GAIN(dB)	MICLVOL	GAIN(dB)
000000	0	010000	16	100000	32
000001	1	010001	17	100001	33
000010	2	010010	18	100010	34
000011	3	010011	19	100011	35
000100	4	010100	20	100100	36
000101	5	010101	21	100101	37
000110	6	010110	22	100110	38
000111	7	010111	23	100111	39
001000	8	011000	24	101000	40
001001	9	011001	25	101001	41
001010	10	011010	26	101010	42
001011	11	011011	27	101011	43
001100	12	011100	28	101100	44
001101	13	011101	29	101101	45
001110	14	011110	30	101110	46
001111	15	011111	31	Other values	46

Name: MICRVOL
Access: Read / Write
Address: 0x17

7	6	5	4	3	2	1	0
-	-	MICRVOL					

Table 13-39. MICRVOL (0x17) Structure

Bit	Name	Description	Reset value
7:6	-	unused	0
5:0	MICRVOL	Microphone Right volume selection	000000

Table 13-40. Microphone Right Volume Selection Table

MICRVOL	GAIN(dB)	MICRVOL	GAIN(dB)	MICRVOL	GAIN(dB)
000000	0	010000	16	100000	32
000001	1	010001	17	100001	33
000010	2	010010	18	100010	34
000011	3	010011	19	100011	35
000100	4	010100	20	100100	36
000101	5	010101	21	100101	37
000110	6	010110	22	100110	38
000111	7	010111	23	100111	39
001000	8	011000	24	101000	40
001001	9	011001	25	101001	41
001010	10	011010	26	101010	42
001011	11	011011	27	101011	43
001100	12	011100	28	101100	44
001101	13	011101	29	101101	45
001110	14	011110	30	101110	46
001111	15	011111	31	Other values	46

Name: INLVOL
Access: Read / Write
Address: 0x18

7	6	5	4	3	2	1	0
INLBOTH		INLVOL					

Table 13-41. INLVOL (0x18) Structure

Bit	Name	Description	Reset value
7	INLBOTH	AUX / LINE Left volume controls Right channel 0: inactive 1: active. Priority bit over INRBOTH.	1
6:0	INLVOL	AUX / LINE input Left volume selection	0000000

Table 13-42. AUX / LINE Left Volume Selection Table

INLVOL	GAIN(dB)	INLVOL	GAIN(dB)	INLVOL	GAIN(dB)
≤1011100	MUTE	1101101	-19	1111110	-2
1011101	-35	1101110	-18	1111111	-1
1011110	-34	1101111	-17	0000000	0
1011111	-33	1110000	-16	0000001	1
1100000	-32	1110001	-15	0000010	2
1100001	-31	1110010	-14	0000011	3
1100010	-30	1110011	-13	0000100	4
1100011	-29	1110100	-12	0000101	5
1100100	-28	1110101	-11	0000110	6
1100101	-27	1110110	-10	0000111	7
1100110	-26	1110111	-9	0001000	8
1100111	-25	1111000	-8	0001001	9
1101000	-24	1111001	-7	0001010	10
1101001	-23	1111010	-6	0001011	11
1101010	-22	1111011	-5	≥0101111	12
1101011	-21	1111100	-4		
1101100	-20	1111101	-3		

Name: INRVOL
Access: Read / Write
Address: 0x19

7	6	5	4	3	2	1	0
INRBOTH		INRVOL					

Table 13-43. INRVOL (0x19) Structure

Bit	Name	Description	Reset value
7	INRBOTH	AUX / LINE Right volume controls left channel 0: inactive 1: active.	0
6:0	INRVOL	AUX / LINE input Right volume selection	0000000

Table 13-44. AUX / LINE Right Volume Selection Table

INLVOL	GAIN(dB)	INLVOL	GAIN(dB)	INLVOL	GAIN(dB)
≤1011100	MUTE	1101101	-19	1111110	-2
1011101	-35	1101110	-18	1111111	-1
1011110	-34	1101111	-17	0000000	0
1011111	-33	1110000	-16	0000001	1
1100000	-32	1110001	-15	0000010	2
1100001	-31	1110010	-14	0000011	3
1100010	-30	1110011	-13	0000100	4
1100011	-29	1110100	-12	0000101	5
1100100	-28	1110101	-11	0000110	6
1100101	-27	1110110	-10	0000111	7
1100110	-26	1110111	-9	0001000	8
1100111	-25	1111000	-8	0001001	9
1101000	-24	1111001	-7	0001010	10
1101001	-23	1111010	-6	0001011	11
1101010	-22	1111011	-5	≥0101111	12
1101011	-21	1111100	-4		
1101100	-20	1111101	-3		

Name: HPLVOL
Access: Read / Write
Address: 0x1A

7	6	5	4	3	2	1	0
HPLVOL							

Table 13-45. HPLVOL (0x1A) Structure

Bit	Name	Description	Reset value
7:0	HPLVOL	Headphone Left volume selection	00000000

Table 13-46. Headphone Left Volume Selection Table

HPLVOL	GAIN (dB)	HPLVOL	GAIN (dB)	HPLVOL	GAIN (dB)	HPLVOL	GAIN (dB)
≤10110010	MUTE	11001000	-56	11011110	-34	11110100	-12
10110011	-77	11001001	-55	11011111	-33	11110101	-11
10110100	-76	11001010	-54	11100000	-32	11110110	-10
10110101	-75	11001011	-53	11100001	-31	11110111	-9
10110110	-74	11001100	-52	11100010	-30	11111000	-8
10110111	-73	11001101	-51	11100011	-29	11111001	-7
10111000	-72	11001110	-50	11100100	-28	11111010	-6
10111001	-71	11001111	-49	11100101	-27	11111011	-5
10111010	-70	11010000	-48	11100110	-26	11111100	-4
10111011	-69	11010001	-47	11100111	-25	11111101	-3
10111100	-68	11010010	-46	11101000	-24	11111110	-2
10111101	-67	11010011	-45	11101001	-23	11111111	-1
10111110	-66	11010100	-44	11101010	-22	00000000	0
10111111	-65	11010101	-43	11101011	-21	00000001	1
11000000	-64	11010110	-42	11101100	-20	00000010	2
11000001	-63	11010111	-41	11101101	-19	00000011	3
11000010	-62	11011000	-40	11101110	-18	00000100	4
11000011	-61	11011001	-39	11101111	-17	00000101	5
11000100	-60	11011010	-38	11110000	-16	≥00000110	6
11000101	-59	11011011	-37	11110001	-15		
11000110	-58	11011100	-36	11110010	-14		
11000111	-57	11011101	-35	11110011	-13		

Name: HPRVOL
Access: Read / Write
Address: 0x1B

7	6	5	4	3	2	1	0
HPRVOL							

Table 13-47. HPRVOL (0x1B) Structure

Bit	Name	Description	Reset value
7:0	HPRVOL	HEADSET Right volume selection	00000000

Table 13-48. Headphone Right Volume Selection Table

HPRVOL	GAIN (dB)	HPRVOL	GAIN (dB)	HPRVOL	GAIN (dB)	HPRVOL	GAIN (dB)
≤10110010	MUTE	11001000	-56	11011110	-34	11110100	-12
10110011	-77	11001001	-55	11011111	-33	11110101	-11
10110100	-76	11001010	-54	11100000	-32	11110110	-10
10110101	-75	11001011	-53	11100001	-31	11110111	-9
10110110	-74	11001100	-52	11100010	-30	11111000	-8
10110111	-73	11001101	-51	11100011	-29	11111001	-7
10111000	-72	11001110	-50	11100100	-28	11111010	-6
10111001	-71	11001111	-49	11100101	-27	11111011	-5
10111010	-70	11010000	-48	11100110	-26	11111100	-4
10111011	-69	11010001	-47	11100111	-25	11111101	-3
10111100	-68	11010010	-46	11101000	-24	11111110	-2
10111101	-67	11010011	-45	11101001	-23	11111111	-1
10111110	-66	11010100	-44	11101010	-22	00000000	0
10111111	-65	11010101	-43	11101011	-21	00000001	1
11000000	-64	11010110	-42	11101100	-20	00000010	2
11000001	-63	11010111	-41	11101101	-19	00000011	3
11000010	-62	11011000	-40	11101110	-18	00000100	4
11000011	-61	11011001	-39	11101111	-17	00000101	5
11000100	-60	11011010	-38	11110000	-16	≥00000110	6
11000101	-59	11011011	-37	11110001	-15		
11000110	-58	11011100	-36	11110010	-14		
11000111	-57	11011101	-35	11110011	-13		

Name: HP_CONTROL

Access: Read / Write

Address: 0x1C

7	6	5	4	3	2	1	0
-	-	-	-	-	HPDET_ST	LHPBOTH	RHPBOTH

Table 13-49. HP_CONTROL (0x1C) Structure

Bit	Name	Description	Reset value
7:3	-	unused	00000
2	HPDET_ST	Headphone plug in-out detector 0: OFF 1: ON	0
1	LHPBOTH	Right Headphone volume follows left 0: inactive 1: active. Priority bit over RHPBOTH.	1
0	RHPBOTH	Left Headphone volume follows right 0: inactive 1: active	0

Name: AUDIO_EFFECTS

Access: Read / Write

Address: 0x1D

7	6	5	4	3	2	1	0
3DFX_DEPTH		ON3DFX	SWAP_DAC	SWAP_ADC	MONO_DAC	MONO_ADC	ONDEEMP

Table 13-50. AUDIO_EFFECTS (0x1D) Structure

Bit	Name	Description	Reset value
7:6	3DFX_DEPTH	3D effect depth control	00
5	ON3DFX	3D effect 0: OFF 1: ON	0
4	SWAP_DAC	DAC Left / Right channel swap 0: Left / Right inputs on Left / Right outputs 1: Left / Right inputs on Right / Left outputs	0
3	SWAP_ADC	ADC Left / Right channel swap 0: Left / Right inputs on Left / Right outputs 1: Left / Right inputs on Right / Left outputs	0
2	MONO_DAC	(Left + Right) / 2 on Left and Right channels 0: inactive 1: active	0
1	MONO_ADC	Left ADC output on both Left and Right channels 0: inactive 1: active	0
0	ONDEEMP	De-emphasis filter 0: OFF 1: ON	0

Table 13-51. 3-D Effect Depth Control Table

3DFX_DEPTH	Attenuation
00	0dB
01	-6dB
10	-12dB
11	-18dB

Name: INPUT_CONTROL

Access: Read / Write.

This register is modified by Audio Controller at audio path change.

Address: 0x1E

7	6	5	4	3	2	1	0
-	LINESEL	ONMICL	ONMICR	ONADCL	ONADCR	ONLINL	ONLINR

Table 13-52. INPUT_CONTROL (0x1E) Structure

Bit	Name	Description	Reset value
7		unused	0
6	LINESEL	LINE / AUX input selection 0: Aux input selected 1: Line input selected	1
5	ONMICL	Left microphone amplifier 0: OFF 1: ON	0
4	ONMICR	Right microphone amplifier 0: OFF 1: ON	0
3	ONADCL	Left ADC 0: OFF 1: ON	0
2	ONADCR	Right ADC 0: OFF 1: ON	0
1	ONLINL	Left line input amplifier 0: OFF 1: ON	0
0	ONLINR	Right line input amplifier 0: OFF 1: ON	0

Name: OUTPUT_CONTROL

Access: Read / Write

This register is modified by Audio Controller at audio path change.

Address: 0x1F

7	6	5	4	3	2	1	0
-	ONSIDETONE	ONPLAYBACK	ONBYPASS	ONHPL	ONHPR	ONDAACL	ONDACR

Table 13-53. OUTPUT_CONTROL (0x1F) Structure

Bit	Name	Description	Reset value
7		unused	0
6	ONSIDETONE	Sidetone switch 0: muted 1: enabled	0
5	ONPLAYBACK	Playback switch 0: muted 1: enabled	0
4	ONBYPASS	Bypass switch 0: muted 1: enabled	0
3	ONHPL	Left headphone amplifier 0: OFF 1: ON	0
2	ONHPR	Right headphone amplifier 0: OFF 1: ON	0
1	ONDAACL	Left DAC 0: OFF 1: ON	0
0	ONDACR	Right DAC 0: OFF 1: ON	0

Name: INPUT_MIXER

Access: Read / Write

This register is modified by Audio Controller at audio path change.

Address: 0x20

7	6	5	4	3	2	1	0
-	-	MIXMICL	MIXMICR	MIXLINEL	MIXLINER	ONMIXL	ONMIXR

Table 13-54. INPUT_MIXER (0x20) Structure

Bit	Name	Description	Reset value
7:6	-	unused	00
5	MIXMICL	Left microphone input mixer switch 0: muted 1: enabled	0
4	MIXMICR	Right microphone input mixer switch 0: muted 1: enabled	0
3	MIXLINEL	Left line / aux input mixer switch 0: muted 1: enabled	0
2	MIXLINER	Right line / aux input mixer switch 0: muted 1: enabled	0
1	ONMIXL	Left input mixer ON / OFF 0: muted 1: enabled	0
0	ONMIXR	Right input mixer ON / OFF 0: muted 1: enabled	0

Name: SIDETONE_VOL

Access: Read / Write

Address: 0x21

7	6	5	4	3	2	1	0
-	-	-	SIDETONE_VOL				

Table 13-55. SIDETONE_VOL (0x21) Structure

Bit	Name	Description	Reset value
7:5		unused	000
4:0	SIDETONE_VOL	Left / Right sidetone path attenuation	01011

Table 13-56. Left / Right Sidetone Path Attenuation Selection Table

SIDETONE_VOL	ATT(dB)	SIDETONE_VOL	ATT(dB)	SIDETONE_VOL	ATT(dB)
00000	0	00100	12	01000	24
00001	3	00101	15	01001	27
00010	6	00110	18	01010	30
00011	9	00111	21	>=01011	30

Name: EQUALIZER

Access: Read / Write

Address: 0x22

7	6	5	4	3	2	1	0
-	-	-	-	EQ_SEL			

Table 13-57. EQUALIZER (0x22) Structure

Bit	Name	Description	Reset value
7:4			0
3:0	EQ_SEL	Equalizer selection	0000

Table 13-58. Equalizer Selection Table(0x22) Structure

EQ_SEL	Description
0000	Flat Response
0001	Bass boost +12dB
0010	Bass boost +6dB
0011	Bass cut -12dB
0100	Bass cut -6dB
0101	Medium boost +3dB
0110	Medium boost +8dB
0111	Medium cut -3dB
1000	Medium cut -8dB
1001	Treble boost +12dB
1010	Treble boost +6dB
1011	Treble cut -12dB
1100	Treble cut -6dB
Other value	Flat response.

Name: ADC_CTRL
Access: Read / Write
Address: 0x30

7	6	5	4	3	2	1	0
ON_ADC	ON_BUF	-	-	-	TS		

Table 13-59. ADC_CTRL (0x30) Structure

Bit	Name	Description	Reset value
7	ON_ADC	ADC function 0: OFF 1: ON	0
6	ON_BUF	Analog buffer 0: OFF 1: ON	0
5:3	unused	-	000
2:0	TS	Sampling period	000

Table 13-60. ADC Sampling Period Selection Table

TS	SAMPLING PERIOD (s)
000	0.01
001	0.02
010	0.1
011	1
100	2
101	3
110	4
111	Max speed

Name: ADC_MUX_1

Access: Read / Write

Address: 0x31

7	6	5	4	3	2	1	0
-	VIN	-	VDD4	VDD3	VDD2	VDD1	VDD0

Table 13-61. ADC_MUX1 (0x31) Structure

Bit	Name	Description	Reset value
7	unused	-	0
6	VIN	VIN channel selection 0: Not selected 1: Selected	1
5	unused	-	1
4	VDD4	VDD4 channel selection 0: Not selected 1: Selected	1
3	VDD3	VDD3 channel selection 0: Not selected 1: Selected	1
2	VDD2	VDD2 channel selection 0: Not selected 1: Selected	1
1	VDD1	VDD1 channel selection 0: Not selected 1: Selected	1
0	VDD0	VDD0 channel selection 0: Not selected 1: Selected	1

Name: ADC_MUX_2

Access: Read / Write

Address: 0x32

7	6	5	4	3	2	1	0
-	-	-	-	ANA3	ANA2	ANA1	ANA0

Table 13-62. ADC_MUX2 (0x32) Structure

Bit	Name	Description	Reset value
7:4	unused	-	0000
3	ANA3	ANA3 channel selection 0: Not selected 1: Selected	1
2	ANA2	ANA2 channel selection 0: Not selected 1: Selected	1
1	ANA1	ANA1 channel selection 0: Not selected 1: Selected	1
0	ANA0	ANA0 channel selection 0: Not selected 1: Selected	1

Name: ADC_ANA0_MSB

Access: Read Only

Address: 0x33

7	6	5	4	3	2	1	0
ADC<9:2>							

Table 13-63. ADC_ANA0_MSB (0x33) Structure

Bit	Name	Description	Reset value
7:0	ADC<9:2>	ADC_OUT<9:2> for ANA0 Channel	00000000

Name: ADC_ANA0_LSB

Access: Read Only

Address: 0x34

7	6	5	4	3	2	1	0
							ADC<1:0>

Table 13-64. ADC_ANA0_LSB (0x34) Structure

Bit	Name	Description	Reset value
7:2	-	unused	
1:0	ADC<1:0>	ADC_OUT<1:0> for ANA0 Channel	00

Name: ADC_ANA1_MSB

Access: Read Only

Address: 0x35

7	6	5	4	3	2	1	0
ADC<9:2>							

Table 13-65. ADC_ANA1_MSB (0x35) Structure

Bit	Name	Description	Reset value
7:0	ADC<9:2>	ADC_OUT<9:2> for ANA1 Channel	00000000

Name: ADC_ANA1_LSB

Access: Read Only

Address: 0x36

7	6	5	4	3	2	1	0
							ADC<1:0>

Table 13-66. ADC_ANA1_LSB (0x36) Structure

Bit	Name	Description	Reset value
7:2	-	unused	
1:0	ADC<1:0>	ADC_OUT<1:0> for ANA1 Channel	00

Name: ADC_ANA2_MSB

Access: Read Only

Address: 0x37

7	6	5	4	3	2	1	0
ADC<9:2>							

Table 13-67. ADC_ANA2_MSB (0x37) Structure

Bit	Name	Description	Reset value
7:0	ADC<9:2>	ADC_OUT<9:2> for ANA2 Channel	00000000

Name: ADC_ANA2_LSB

Access: Read Only

Address: 0x38

7	6	5	4	3	2	1	0
							ADC<1:0>

Table 13-68. ADC_ANA2_LSB (0x38) Structure

Bit	Name	Description	Reset value
7:2	-	unused	
1:0	ADC<1:0>	ADC_OUT<1:0> for ANA2 Channel	00

Name: ADC_ANA3_MSB

Access: Read Only

Address: 0x39

7	6	5	4	3	2	1	0
ADC<9:2>							

Table 13-69. ADC_ANA3_MSB (0x39) Structure

Bit	Name	Description	Reset value
7:0	ADC<9:2>	ADC_OUT<9:2> for ANA3 Channel	00000000

Name: ADC_ANA3_LSB

Access: Read Only

Address: 0x3A

7	6	5	4	3	2	1	0
							ADC<1:0>

Table 13-70. ADC_ANA3_LSB (0x3A) Structure

Bit	Name	Description	Reset value
7:2	-	unused	
1:0	ADC<1:0>	ADC_OUT<1:0> for ANA3 Channel	00

Name: ADC_VDD0_MSB

Access: Read Only

Address: 0x3B

7	6	5	4	3	2	1	0
ADC<9:2>							

Table 13-71. ADC_VDD0_MSB (0x3B) Structure

Bit	Name	Description	Reset value
7:0	ADC<9:2>	ADC_OUT<9:2> for VDD0 Channel	00000000

Name: ADC_VDD0_LSB

Access: Read Only

Address: 0x3C

7	6	5	4	3	2	1	0
							ADC<1:0>

Table 13-72. ADC_VDD0_LSB (0x3C) Structure

Bit	Name	Description	Reset value
7:2	-	unused	
1:0	ADC<1:0>	ADC_OUT<1:0> for VDD0 Channel	00

Name: ADC_VDD1_MSB

Access: Read Only

Address: 0x3D

7	6	5	4	3	2	1	0
ADC<9:2>							

Table 13-73. ADC_VDD1_MSB (0x3D) Structure

Bit	Name	Description	Reset value
7:0	ADC<9:2>	ADC_OUT<9:2> for VDD1 Channel	00000000

Name: ADC_VDD1_LSB

Access: Read Only

Address: 0x3E

7	6	5	4	3	2	1	0
							ADC<1:0>

Table 13-74. ADC_VDD1_LSB (0x3E) Structure

Bit	Name	Description	Reset value
7:2	-	unused	
1:0	ADC<1:0>	ADC_OUT<1:0> for VDD1 Channel	00

Name: ADC_VDD2_MSB

Access: Read Only

Address: 0x3F

7	6	5	4	3	2	1	0
ADC<9:2>							

Table 13-75. ADC_VDD2_MSB (0x3F) Structure

Bit	Name	Description	Reset value
7:0	ADC<9:2>	ADC_OUT<9:2> for VDD2 Channel	00000000

Name: ADC_VDD2_LSB

Access: Read Only

Address: 0x40

7	6	5	4	3	2	1	0
							ADC<1:0>

Table 13-76. ADC_VDD2_LSB (0x40) Structure

Bit	Name	Description	Reset value
7:2	-	unused	
1:0	ADC<1:0>	ADC_OUT<1:0> for VDD2 Channel	00

Name: ADC_VDD3_MSB

Access: Read Only

Address: 0x41

7	6	5	4	3	2	1	0
ADC<9:2>							

Table 13-77. ADC_VDD3_MSB (0x41) Structure

Bit	Name	Description	Reset value
7:2	ADC<9:2>	ADC_OUT<9:2> for VDD3 Channel	00000000

Name: ADC_VDD3_LSB

Access: Read Only

Address: 0x42

7	6	5	4	3	2	1	0
							ADC<1:0>

Table 13-78. ADC_VDD3_LSB (0x42) Structure

Bit	Name	Description	Reset value
7:2	-	unused	
1:0	ADC<1:0>	ADC_OUT<1:0> for VDD3 Channel	00

Name: ADC_VDD4_MSB

Access: Read Only

Address: 0x43

7	6	5	4	3	2	1	0
ADC<9:2>							

Table 13-79. ADC_VDD4_MSB (0x43) Structure

Bit	Name	Description	Reset value
7:0	ADC<9:2>	ADC_OUT<9:2> for VDD4 Channel	00000000

Name: ADC_VDD4_LSB

Access: Read Only

Address: 0x44

7	6	5	4	3	2	1	0
							ADC<1:0>

Table 13-80. ADC_VDD4_LSB (0x44) Structure

Bit	Name	Description	Reset value
7:2	-	unused	
1:0	ADC<1:0>	ADC_OUT<1:0> for VDD4 Channel	00

Name: ADC_VIN_MSB

Access: Read Only

Address: 0x47

7	6	5	4	3	2	1	0
ADC<9:2>							

Table 13-81. ADC_VIN_MSB (0x47) Structure

Bit	Name	Description	Reset value
7:0	ADC<9:2>	ADC_OUT<9:2> for VIN Channel	00000000

Name: ADC_VIN_LSB

Access: Read Only

Address: 0x48

7	6	5	4	3	2	1	0
							ADC<1:0>

Table 13-82. ADC_VIN_LSB (0x48) Structure

Bit	Name	Description	Reset value
7:2	-	unused	
1:0	ADC<1:0>	ADC_OUT<1:0> for VIN Channel	00

Name: ADC_ANA_LSB

Access: Read Only

Address: 0x49

7	6	5	4	3	2	1	0
ADC_ANA3<1:0>		ADC_ANA2<1:0>		ADC_ANA1<1:0>		ADC_ANA0<1:0>	

Table 13-83. ADC_ANA_LSB (0x49) Structure

Bit	Name	Description	Reset value
7:6	ADC_ANA3<1:0>	ADC_OUT<1:0:> for ANA3 Channel	00
5:4	ADC_ANA2<1:0>	ADC_OUT<1:0:> for ANA2 Channel	00
3:2	ADC_ANA1<1:0>	ADC_OUT<1:0:> for ANA1 Channel	00
1:0	ADC_ANA0<1:0>	ADC_OUT<1:0:> for ANA0 Channel	00

Name: RTC_CTRL

Access: Read / Write

Address: 0x50

7	6	5	4	3	2	1	0
-	-				RTC_WRITE	RTC_SEL	RTC_EN

Table 13-84. RTC_CTRL (0x50) Structure

Bit	Name	Description	Reset value
7:3	-	unused	
2	RTC_WRITE	RTC read/write: RTC_WRITE = 0: Read mode RTC_WRITE = 1: Write mode	0
1	RTC_SEL	RTC block select: RTC_SEL = 0: Not Selected RTC_SEL = 1: Selected	0
0	RTC_EN	RTC block enable: RTC_EN = 0: Disabled RTC_EN = 1: Enabled	0

Name: RTC_ADDR

Access: Read / Write

Address: 0x51

7	6	5	4	3	2	1	0
RTC_ADDR							

Table 13-85. RTC_ADDR (0x51) Structure

Bit	Name	Description	Reset value
7:0	RTC_ADDR	RTC address	0000

Name: RTC_DATA0

Access: Read / Write

Address: 0x52

7	6	5	4	3	2	1	0
RTC_DATA0							

Table 13-86. RTC_DATA0 (0x52) Structure

Bit	Name	Description	Reset value
7:0	RTC_DATA0	RTC DATA 0	0000000

Name: RTC_DATA1

Access: Read / Write

Address: 0x53

7	6	5	4	3	2	1	0
RTC_DATA1							

Table 13-87. RTC_DATA1 (0x53) Structure

Bit	Name	Description	Reset value
7:0	RTC_DATA1	RTC DATA 1	0000000

Name: RTC_DATA2

Access: Read / Write

Address: 0x54

7	6	5	4	3	2	1	0
RTC_DATA2							

Table 13-88. RTC_DATA2 (0x54) Structure

Bit	Name	Description	Reset value
7:0	RTC_DATA2	RTC DATA 2	0000000

Name: RTC_DATA3

Access: Read / Write

Address: 0x55

7	6	5	4	3	2	1	0
RTC_DATA3							

Table 13-89. RTC_DATA3 (0x55) Structure

Bit	Name	Description	Reset value
7:0	RTC_DATA3	RTC DATA 3	0000000

Name: BACKUP_CTRL

Access: Read / Write

Address: 0x56

7	6	5	4	3	2	1	0
-	-	-	-	OSC_UPDT	OSC_EN	OSC_STAT	RST_BKUP

Table 13-90. BACKUP_CTRL (0x56) Structure

Bit	Name	Description	Reset value
7:4	-	unused	0000
3	OSC_UPDT	RTC Oscillator update 0: No action. 1: Update RTC oscillator with OSC_EN	0
2	OSC_EN	RTC Oscillator enable request 0: Oscillator off. 1: Oscillator on.	0
1	OSC_STAT	RTC Oscillator status (read only) 0: Oscillator off. 1: Oscillator on.	0
0	RST_BKUP	Reset of the Backup Area 0: Backup area active 1: Backup area in reset state	0

Name: VERSION

Access: Read

Address: 0x7F

7	6	5	4	3	2	1	0
SOFTWARE_TAG				VERSION			

Table 13-91. VERSION (0x7F) Structure

Bit	Name	Description	Reset value
7:4	SOFTWARE_TAG	Software Tag to identify product specificities as described in Section 17. "Ordering Information" on page 154.	XXXX
3:0	VERSION	'0001': Rev. C samples '0010': Rev. D samples	XXXX

14. PMU and Audio Soft Control: Quick Start

14.1 RTC Examples

14.1.1 RTC Oscillator POWER-ON

```
// Set OSC_EN = 1 and OSC_UPDT = 1
TWI_WRITE 0x0C @BACKUP_CTRL
// Wait > 200us.
WAIT 200us
// Set OSC_UPDT = 0
TWI_WRITE 0x04 @BACKUP_CTRL
// Read BACKUP_CTRL to verify OSC_STAT bit. Result = 0x06.
TWI_READ @BACKUP_CTRL
```

14.1.2 RTC Oscillator POWER-OFF

```
// Set OSC_EN = 0 and OSC_UPDT = 1
TWI_WRITE 0x08 @BACKUP_CTRL
// Wait 200us
WAIT 200us
// Set OSC_UPDT = 0
TWI_WRITE 0x00 @BACKUP_CTRL
// Read BACKUP_CTRL to verify OSC_STAT bit. Result = 0x00.
TWI_READ @BACKUP_CTRL
```

14.1.3 RTC Domain RESET

```
// Set RST_BKUP = 1
TWI_WRITE 0x01 @BACKUP_CTRL
// Wait 200s
WAIT 200us
// Set RST_BKUP = 0
TWI_WRITE 0x00 @BACKUP_CTRL
```

Note: Reset of the RTC domain powers off the RTC oscillator.

14.1.4 RTC Write Operation

The following example makes a generic 32-bit write operation into the RTC macro. The 32-bit data is split into 4 bytes, that are successively sent over the TWI.

```
unsigned int RTC_DATA;
char DATA0 = (char) (RTC_DATA); // LSBs
char DATA1 = (char) (RTC_DATA >> 8);
char DATA2 = (char) (RTC_DATA >> 16);
char DATA3 = (char) (RTC_DATA >> 24); // MSBs
// Select RTC_ADDR = ADDR. ADDR is the RTC macro register to write,
TWI_WRITE ADDR @RTC_ADDR
// Set RTC_DATA0 to RTC_DATA4 registers.
TWI_WRITE DATA0 @RTC_DATA0
TWI_WRITE DATA1 @RTC_DATA1
```

```

TWI_WRITE DATA2 @RTC_DATA2
TWI_WRITE DATA3 @RTC_DATA3
// Set RTC_WRITE = 1 (write) and RTC_SEL = 1
TWI_WRITE 0x06 @ RTC_CTRL
// Pulse RTC_EN
TWI_WRITE 0x07 @ RTC_CTRL
TWI_WRITE 0x06 @ RTC_CTRL
// Disable RTC access
TWI_WRITE 0x00 @ RTC_CTRL

```

14.1.5 RTC Read Operation

The following example makes a generic 32-bit read operation into the RTC macro. The 32-bit RTC data is split into 4 bytes, that are successively read over the TWI.

```

// Select RTC_ADDR = ADDR. ADDR is the RTC macro register to read,
TWI_WRITE ADDR @RTC_ADDR
// Set RTC_WRITE = 0 (read) and RTC_SEL = 1
TWI_WRITE 0x02 @ RTC_CTRL
// Pulse RTC_EN
TWI_WRITE 0x03 @ RTC_CTRL
TWI_WRITE 0x02 @ RTC_CTRL
// Read RTC_DATA0 to RTC_DATA4 registers.
TWI_READ @RTC_DATA0 // LSBs
TWI_READ @RTC_DATA1
TWI_READ @RTC_DATA2
TWI_READ @RTC_DATA3 // MSBs
// Disable RTC access
TWI_WRITE 0x00 @ RTC_CTRL

```

14.1.6 RTC Date and Time Update

In the following example, the RTC date and time is set to “12 October 2004, 08h 49min 59s”. The WRITE_RTC and READ_RTC functions operate as described in the previous sections.

```

// Disable RTC interrupt MASK
TWI_WRITE 0xFE @PMU_MASK
// Enable RTC ACKUPD IT @RTC_IER (RTC_ADDR 0x20).
WRITE_RTC 0x00000001 @RTC_IER
// Set UPDTIME and UPDCAL @RTC_CR (RTC_ADDR 0x00).
WRITE_RTC 0x00000003 @RTC_CR
// Wait ITB low. This ensures that the RTC is ready to be updated.
// Reset IT by read operation, result is 0x01.
TWI_READ @PMU_IT
// Read in RTC_SR that ACKUPD = 1 (RTC_ADDR = 0x18)
READ_RTC @RTC_SR
// Disable ACKUPD IT @RTC_IDR (RTC_ADDR = 0x24)
WRITE_RTC 0x00000001 @RTC_IDR
// Write Date @RTC_CALR (RTC_ADDR = 0x0C) (12 October 2004)
WRITE_RTC 0x12300420 @RTC_CALR

```

```
// Write Time @RTC_TIMR (RTC_ADDR = 0x08) (08h 49min 59s)
WRITE_RTC 0x00084959 @RTC_TIMR
// Start RTC @RTC_CR (RTC_ADDR = 0x00)
WRITE_RTC 0x00000000 @RTC_CR
```

14.2 Audio Examples

14.2.1 Basic Audio Codec Setting Using Automatic Path Control

The following example demonstrates an automatic audio path setting. Assuming that the audio codec is supplied by the LDO4, the sequence is the following:

- Make the codec interface configuration,
- Set the Digital-IN to Headphone-OUT path,
- Put the audio codec in standby mode,
- Release the standby mode to re-activate the selected path,
- Change the path on-the-fly,
- Shutdown the codec.

```
// Start LDO4 @3.3V
TWI_WRITE 0x8C @ VDD4_CTRL

// Digital Audio Interface configuration
// Master clock = 12.288MHz, Master / Slave = slave.
// DAI mode = I2S mode, Word length = 24 bits, FS = 48kHz
TWI_WRITE 0x01 @ DAI_CONTROL
TWI_WRITE 0x63 @ FRAME_CONTROL

// Analog interface configuration
// Mic. config: L & R single ended, Micbias = OFF, Mic. detection = OFF.
// Headphone config: AC coupled,
// Automatic Soft Ramping = ON, ASR timing = 11 (~10ms / step)
TWI_WRITE 0x00 @ MIC_CONTROL
TWI_WRITE 0x27 @ AUDIO_CONTROL

// Analog gain
// Headphone (L & R) gain: -20dB. (LHPBOTH set by default in HP_CONTROL)
// Mic L & R gain: +26 dB.
// Unmute all gains. No power-up is performed.
TWI_WRITE 0xEC @ HPLVOL
TWI_WRITE 0x1A @ MICLVOL
TWI_WRITE 0x1A @ MICRVOL
TWI_WRITE 0x00 @ MUTE

// Audio Start
// ENAC = 1, STANDBY = 1. PATH = 1 (DAC playback)
// At the first start, VMID capacitor is charged.
```

```

// Wait (3.tau) = 300ms with 1uF before standby release. (VMID will be
// discharged only when ENAC = 0.)
// From this point Audio Data can be sent over the Digital audio interface.
TWI_WRITE 0x61 @ AUTOSTART.
WAIT 300ms
// Release standby. The audio codec starts silently, the gains are slowly
// ramped up from mute to the register gains. The codec is active.
TWI_WRITE 0x41 @ AUTOSTART

// Codec Pause by Standby
// All gains are softly ramped down to mute. The codec functions are
// shut down. Current consumption is reduced to a few hundreds of micro-
// amps. VMID remains charged
TWI_WRITE 0x61 @ AUTOSTART

// Pause out: Standby release. The codec softly re-starts.
TWI_WRITE 0x41 @ AUTOSTART

// On-the-fly path change
// PATH = 19: Digital IN to Headphone OUT + Mic IN to Digital OUT.
// The codec controller powers up automatically the new path. The DAC
// playback is not affected by starting the Mic. recording.
TWI_WRITE 0x52 @ AUTOSTART

// Codec Shutdown. ENAC = 0, STANDBY = 1. The codec turns off smoothly.
// In case of AC Coupling output configuration, HPR & HPL will slowly
// discharge following VMID time constant.
TWI_WRITE 0x20 @ AUTOSTART
WAIT 600ms
// Disable DCBLOCK bit.
TWI_WRITE 0x07 @ AUDIO_CONTROL
// LDO4 shutdown.
TWI_WRITE 0x0C @ VDD4_CONTROL

```

14.2.2 Basic Audio Codec Setting Using Custom Path Control

The following example demonstrates a custom audio path setting. Assuming that the audio codec is supplied by the LDO4, the sequence is the following:

- Make the codec analog and digital interfaces configuration,
- Enter the custom path mode and configure a path with DAC input and Headphone Amplifier output,
- Put the audio codec in standby mode,
- Release the standby mode to re-activate the selected path,
- Change the path on-the-fly to add the microphone inputs to the DAC signal,
- Shutdown the codec.

```

// Start LDO4 @3.3V
TWI_WRITE 0x8C @ VDD4_CTRL

// Digital Audio Interface configuration
// Master clock = 12.288MHz, Master / Slave = slave.
// DAI mode = I2S mode, Word length = 24 bits, FS = 48kHz
TWI_WRITE 0x01 @ DAI_CONTROL
TWI_WRITE 0x63 @ FRAME_CONTROL

// Analog interface configuration
// Mic. config: L & R single ended, Micbias = OFF, Mic. detection = OFF.
// Headphone config: AC coupled,
// Automatic Soft Ramping = ON, ASR timing = 11 (~10ms / step)
TWI_WRITE 0x00 @ MIC_CONTROL
TWI_WRITE 0x27 @ AUDIO_CONTROL

// Analog gain
// Headphone (L & R) gain: -20dB. (LHPBOTH set by default in HP_CONTROL)
// Mic L & R gain: +26 dB.
// Unmute all gains. No power-up is performed.
TWI_WRITE 0xEC @ HPLVOL
TWI_WRITE 0x1A @ MICLVOL
TWI_WRITE 0x1A @ MICRVOL
TWI_WRITE 0x00 @ MUTE

// Enter the custom path configuration mode
TWI_WRITE 0x2F @ AUDIO_CONTROL

// Audio Start
// ENAC = 1, STANDBY = 1. PATH = 0 (Not read by the audio controller)
// At the first start, VMID capacitor is charged.
// Wait (3.tau) = 300ms with 1uF before standby release. (VMID will be
// discharged only when ENAC = 0.)
// From this point Audio Data can be sent over the Digital audio interface.
TWI_WRITE 0x60 @ AUTOSTART.
WAIT 300ms

// Audio path definition: DAC input to Headphone output. The software sets
// the bits: ONDAACL, ONDACR, ONHPL, ONHPR and PLAYBACK by writing
// the registers INPUT_CONTROL, OUTPUT_CONTROL, and INPUT_MIXER.
// The changes are not taken immediately into account (ENCONF = 0).
TWI_WRITE 0x40 @ INPUT_CTRL
TWI_WRITE 0x2F @ OUTPUT_CTRL
TWI_WRITE 0x00 @ INPUT_MIXER

// ENCONF pulse: the audio controller takes the requested changes into

```



```
// account.
TWI_WRITE 0x3F @ AUDIO_CONTROL
TWI_WRITE 0x2F @ AUDIO_CONTROL

// STANDBY release. The codec softly starts.
TWI_WRITE 0x40 @ AUTOSTART.

// Codec Pause by Standby
// All gains are softly ramped down to mute. The codec functions are
// shut down. Current consumption is reduced to a few hundreds of micro-
// amps. VMID remains charged
TWI_WRITE 0x60 @ AUTOSTART

// Pause out: Standby release. The codec softly re-starts.
TWI_WRITE 0x40 @ AUTOSTART

// On-the-fly path change: the stereo microphone inputs are added to the
// DAC playback. The software sets: ONMICL, ONMICR, and ONSIDETONE.
TWI_WRITE 0x70 @ INPUT_CTRL
TWI_WRITE 0x6F @ OUTPUT_CTRL
TWI_WRITE 0x00 @ INPUT_MIXER

// Sidetone gain
TWI_WRITE 0x00 @ SIDETONE_VOL

// ENCONF pulse: the audio controller takes the requested changes into
// account. The path modification is here immediate because STANDBY=0.
TWI_WRITE 0x3F @ AUDIO_CONTROL
TWI_WRITE 0x2F @ AUDIO_CONTROL

// Codec Shutdown. ENAC = 0, STANDBY = 1. The codec turns off smoothly.
// In case of AC Coupling output configuration, HPR & HPL will slowly
// discharge following VMID time constant.
TWI_WRITE 0x20 @ AUTOSTART
WAIT 600ms
// Disable DCBLOCK bit.
TWI_WRITE 0x07 @ AUDIO_CONTROL
// LDO4 shutdown.
TWI_WRITE 0x0C @ VDD4_CONTROL
```



15. Typical Performance Characteristics

15.1 PMU: Power Supply Sequences

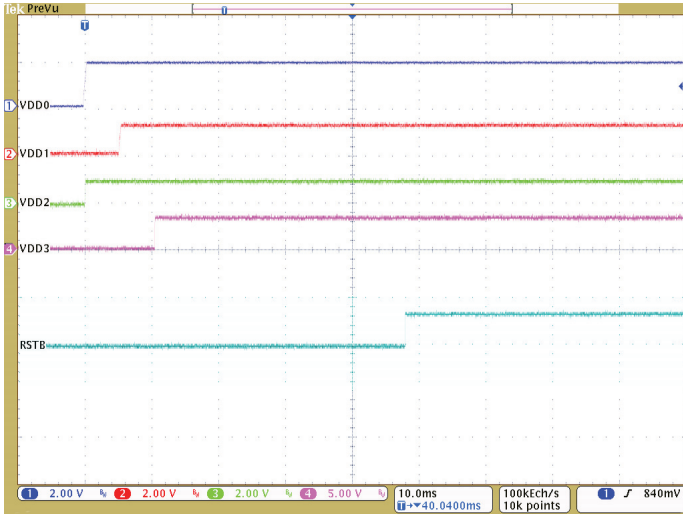
Figure 15-1. Powerdown State to Run State Supplies Start-Up

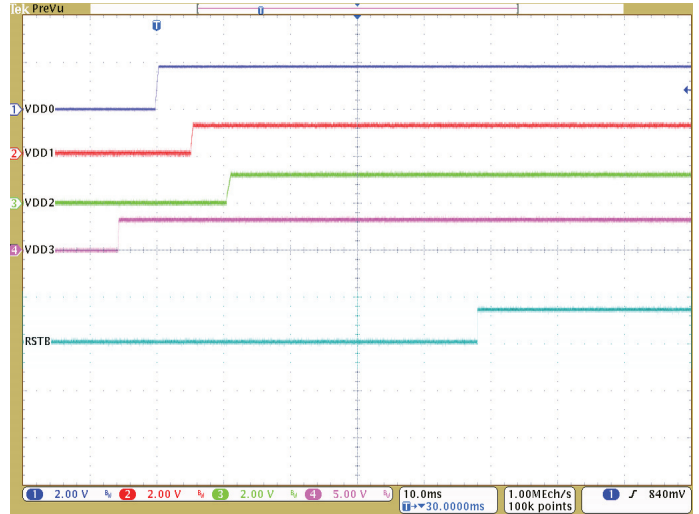

Powerdown to Run State
SEQUENCE A



Powerdown to Run State
SEQUENCE B

Figure 15-2. Run State to Powerdown State Supplies Shut-Down

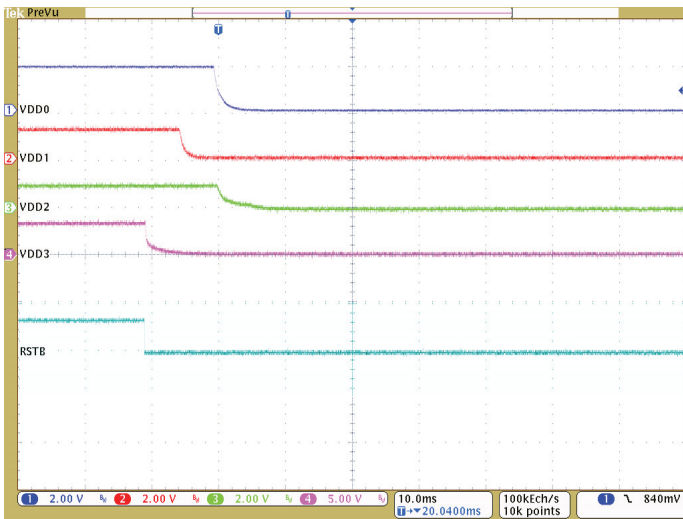

Run to Powerdown State
SEQUENCE A

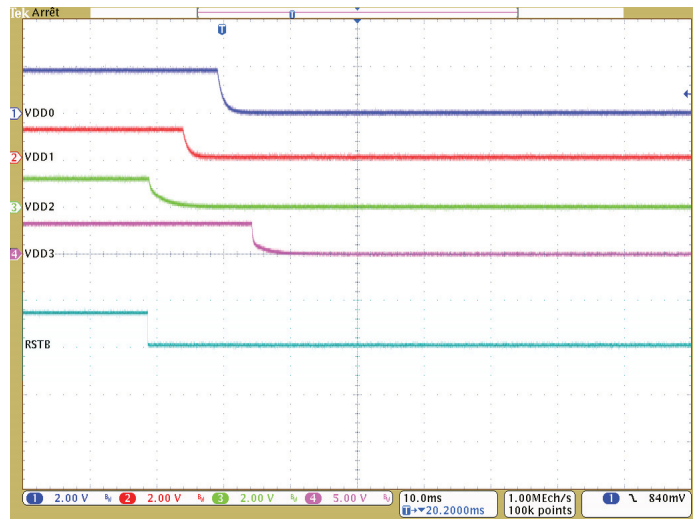

Run to Powerdown State
SEQUENCE B

Figure 15-3. Detailed Supplies Start-Up



Detailed Supplies Start-Up
SEQUENCE A

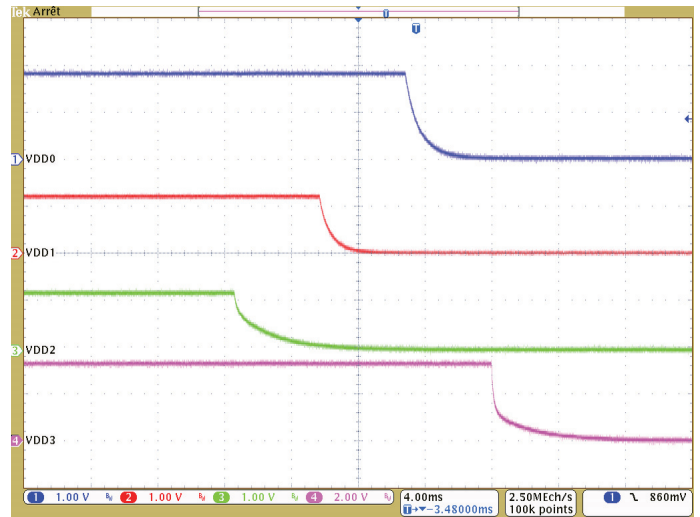

Detailed Supplies Start-Up
SEQUENCE B

Figure 15-4. Detailed Supplies Shutdown

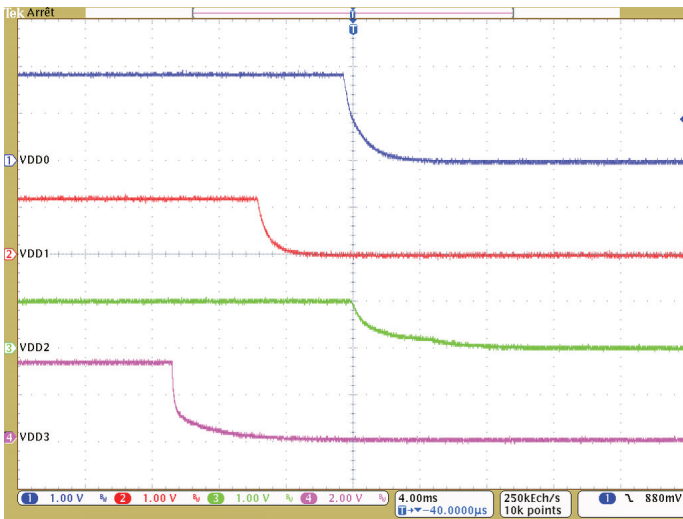

Detailed Supplies Shutdown
SEQUENCE A

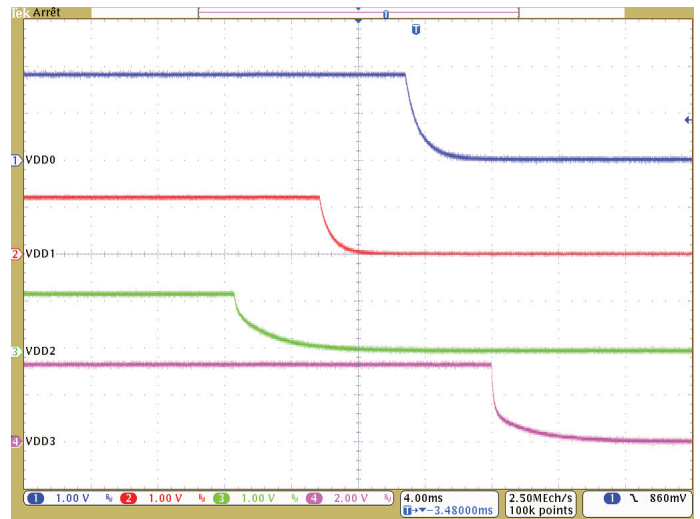

Detailed Supplies shutdown
SEQUENCE B

Figure 15-5. Run State to Standby State

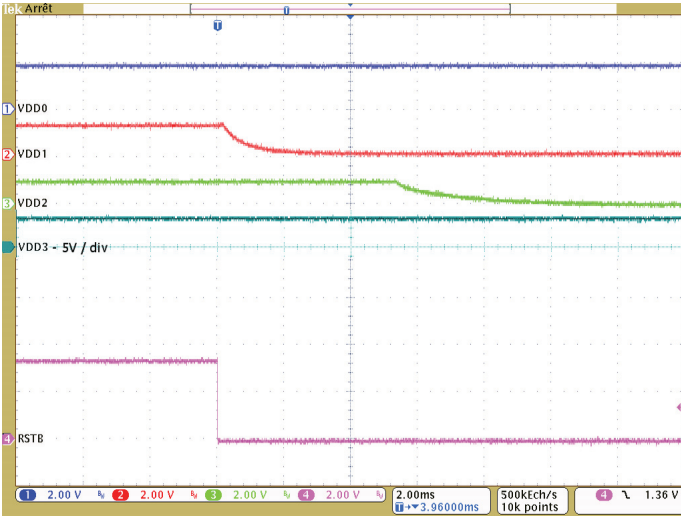

Run To Standby State (default setting)
SEQUENCE A

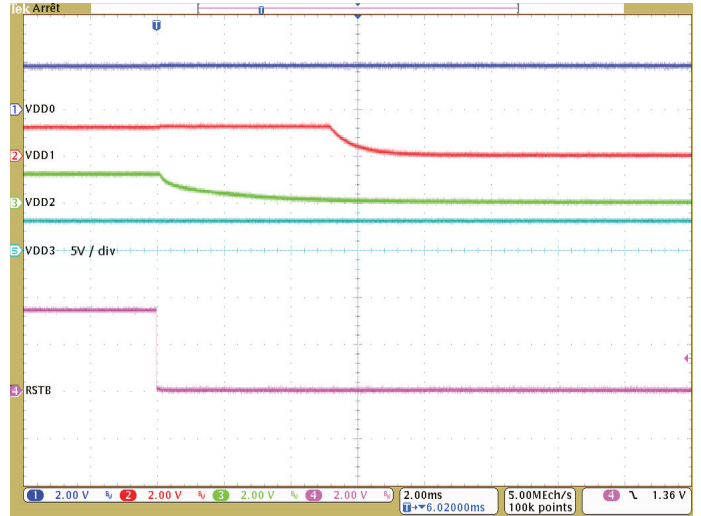

Run To Standby State (default setting)
SEQUENCE B

Figure 15-6. Standby To Run State

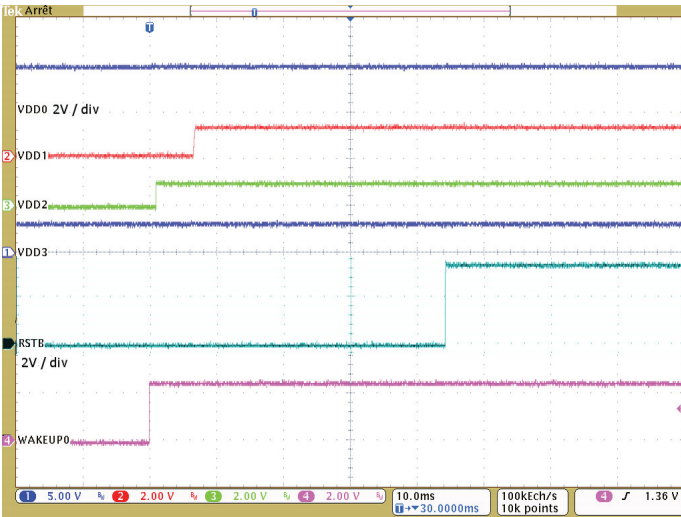

Standby To Run State (default setting)
SEQUENCE A

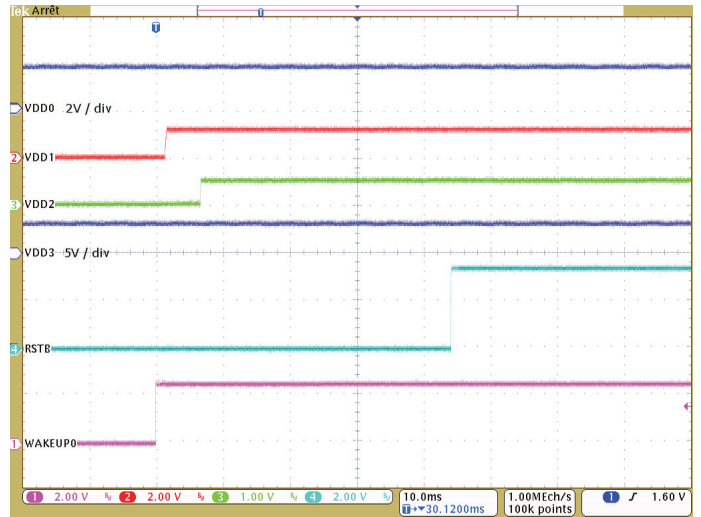

Standby To Run State (default setting)
SEQUENCE B

15.2 DCDC0 and DCDC1

Unless otherwise noted, the reported measurement were performed at room temperature. External components are those described in [Section 5. "Application Block Diagram" on page 8.](#)

Figure 15-7. DCDC0 Transient Load Regulation Performance

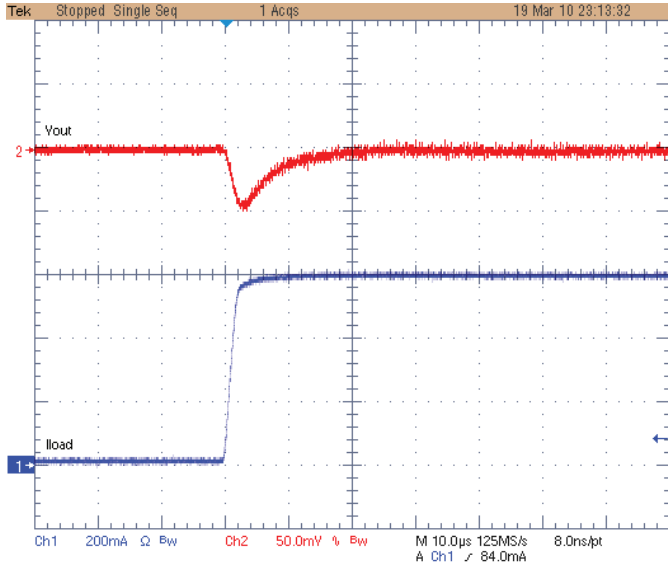

DCDC0 - VIN = 3.3V - VOUT = 1.85V
Load Step 0 To 600mA / 1us

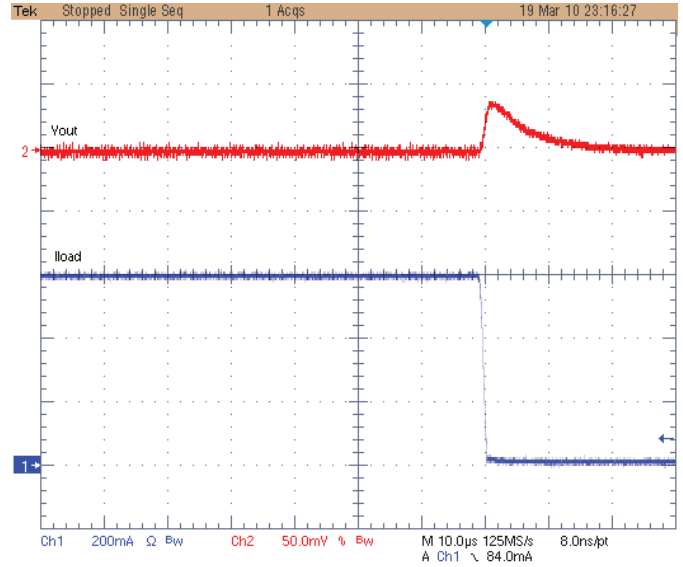

DCDC0 - VIN = 3.3V - VOUT = 1.85V
Load Step 600 To 0mA / 1us

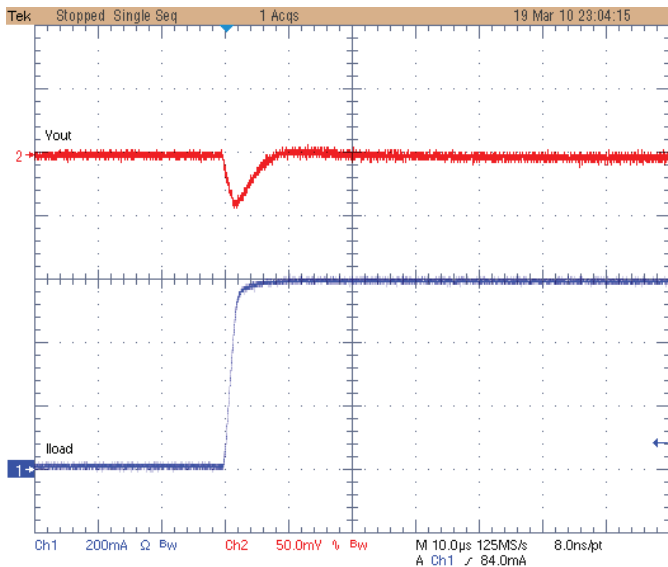

DCDC0 - VIN = 5.5V - VOUT = 1.85V
Load Step 0 To 600mA / 1us

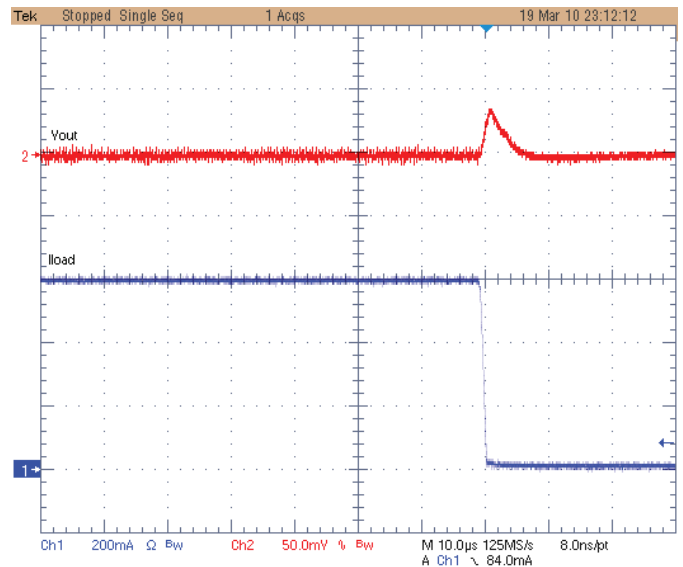

DCDC0 - VIN = 5.5V - VOUT = 1.85V
Load Step 600 To 0mA / 1us

Figure 15-8. DCDC0 Ripple and Efficiency Performance

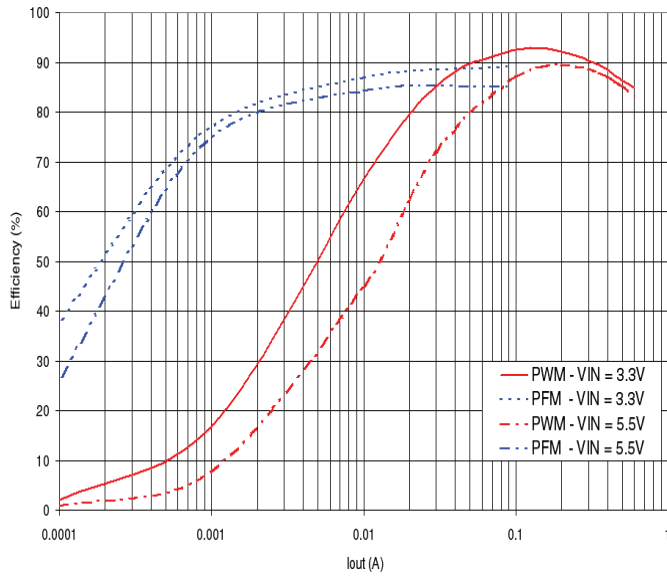

DCDC0 - V_{OUT} = 1.8V
Efficiency in PFM and PWM modes

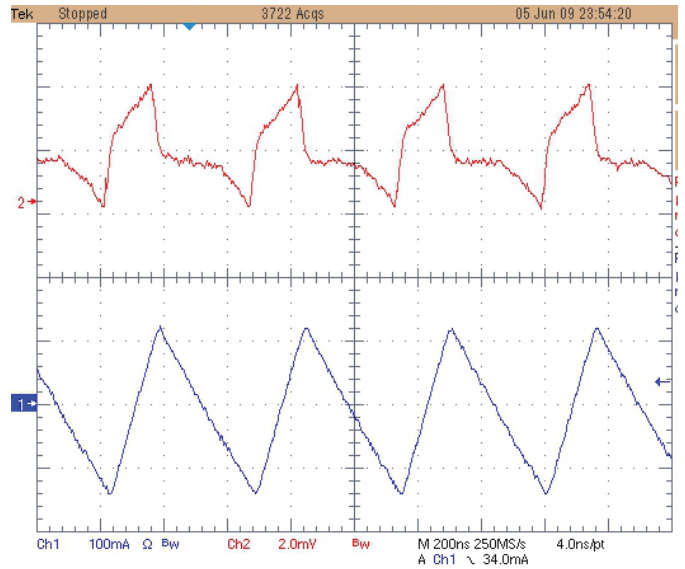

DCDC0 - VIN = 5.5V - V_{OUT} = 1.8V
Output Voltage Ripple

Figure 15-9. DCDC1 Transient Load Regulation Performance

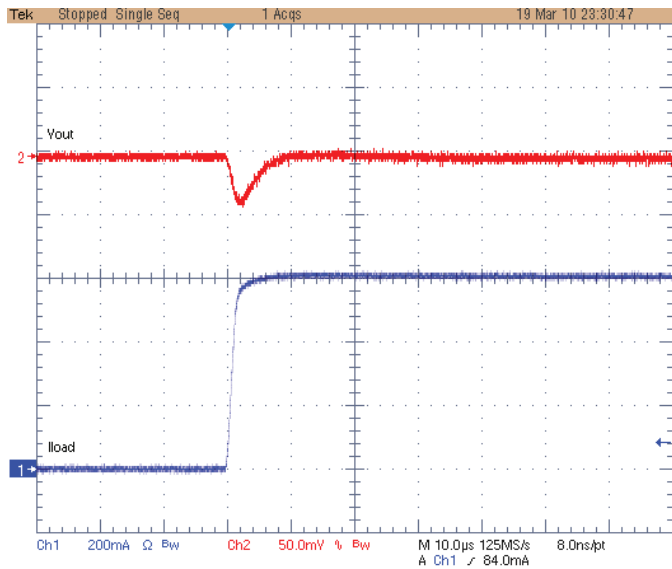

DCDC0 - VIN = 3.3V - VOUT = 1.2V
Load Step 0 To 600mA / 1µs

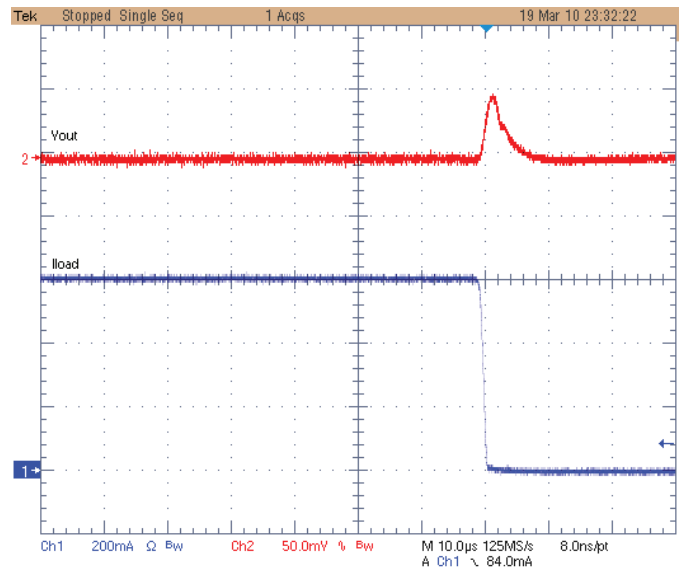

DCDC0 - VIN = 3.3V - VOUT = 1.2V
Load Step 600 To 0mA / 1µs

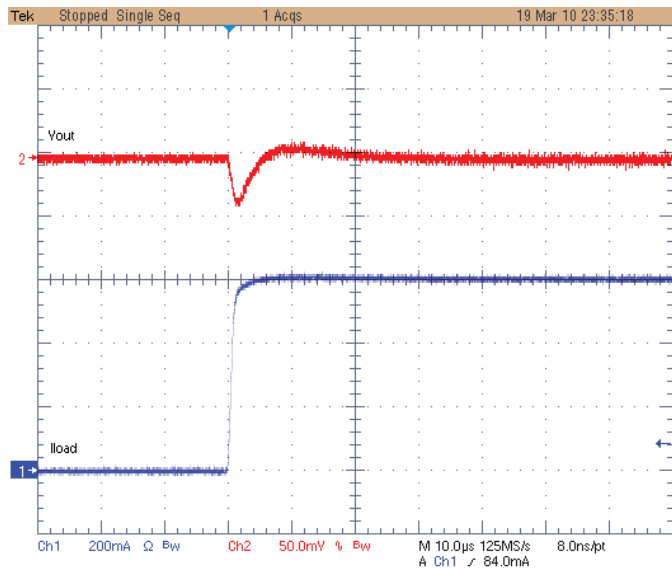

DCDC0 - VIN = 5.5V - VOUT = 1.2V
Load Step 0 To 600mA / 1µs

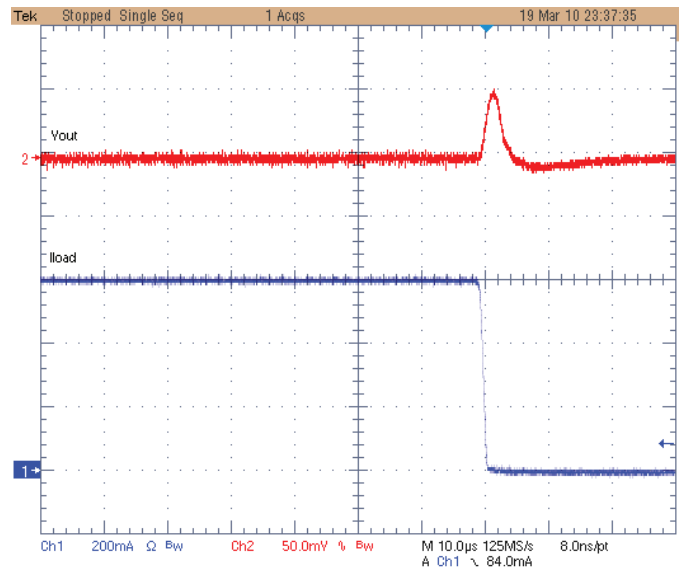

DCDC0 - VIN = 5.5V - VOUT = 1.2V
Load Step 600 To 0mA / 1µs

Figure 15-10. DCDC0 Ripple and Efficiency Performance

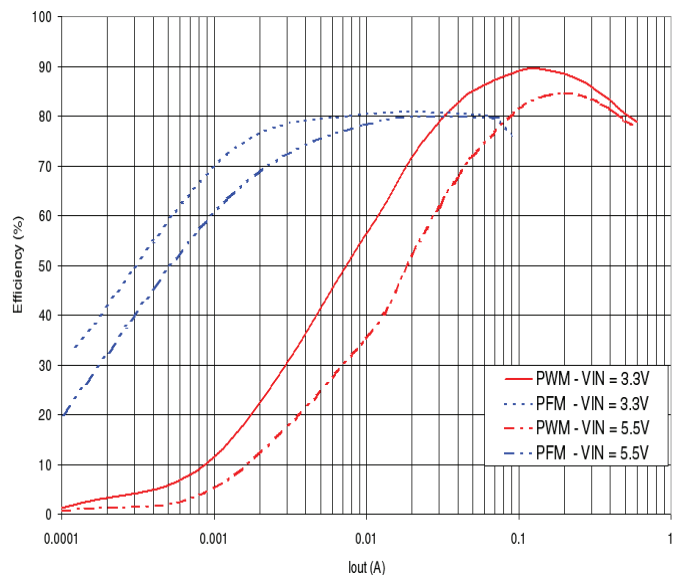

DCDC1 - V_{OUT} = 1.2V
Efficiency in PFM and PWM modes

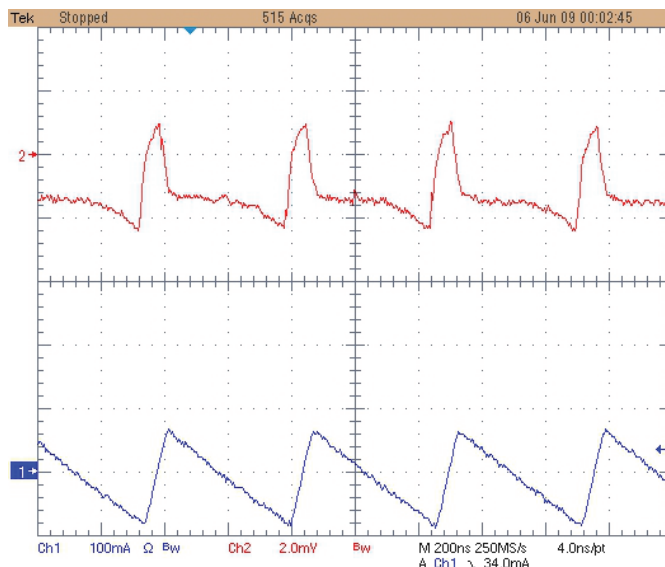

DCDC1 - V_{IN} = 5.5V - V_{OUT} = 1.2V
Output Voltage Ripple

15.3 LDO2

Unless otherwise noted, the reported measurement were performed at room temperature. External components are those described in Section 5. "Application Block Diagram" on page 8.

Figure 15-11. LDO2 Tansient and Static Load Regulation Performance

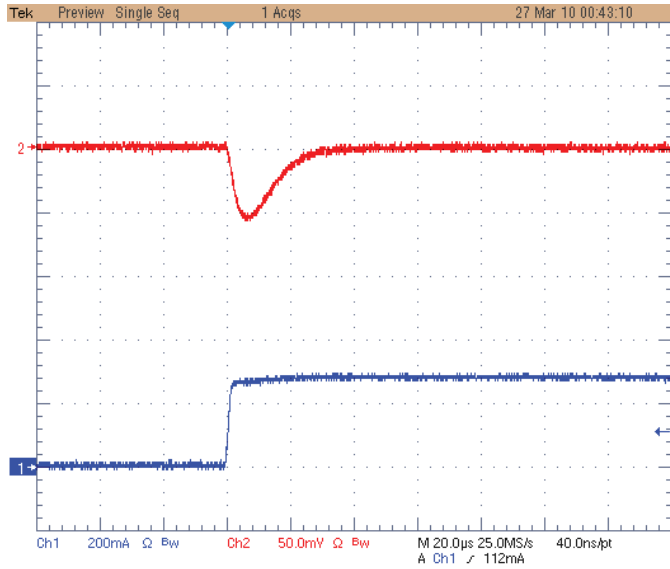

LDO2- VIN = 1.8V - VOUT = 1V
Load Step 0 To 300mA / 1us

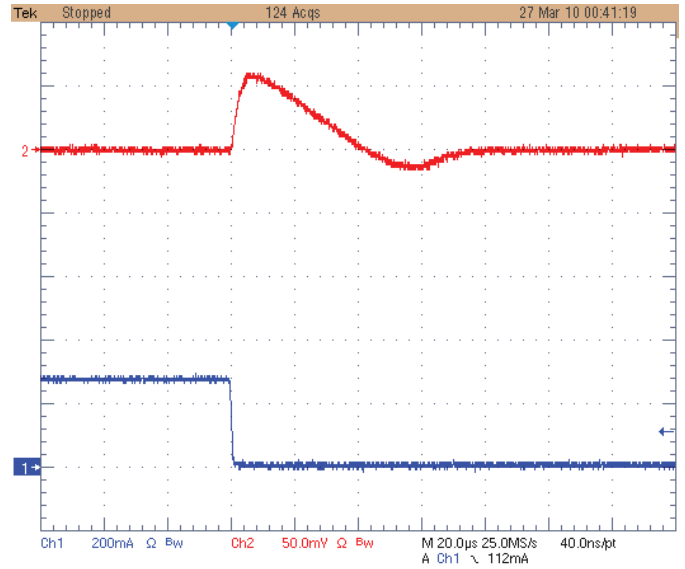

LDO2 - VIN = 1.8V - VOUT = 1V
Load Step 300 To 0mA / 1us

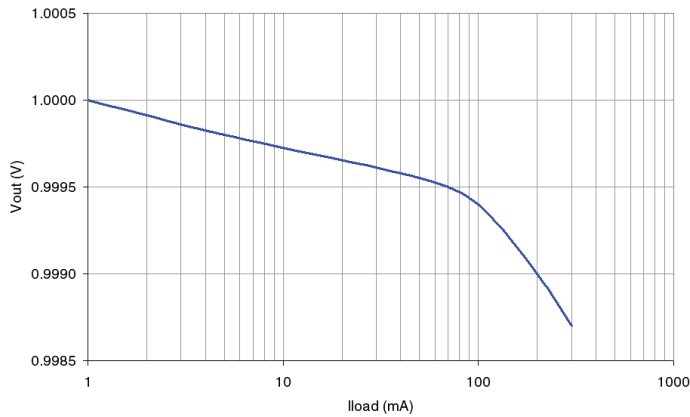

LDO2 - VIN = 1.8V - VOUT = 1V
Static Load Regulation - 0 To 300mA

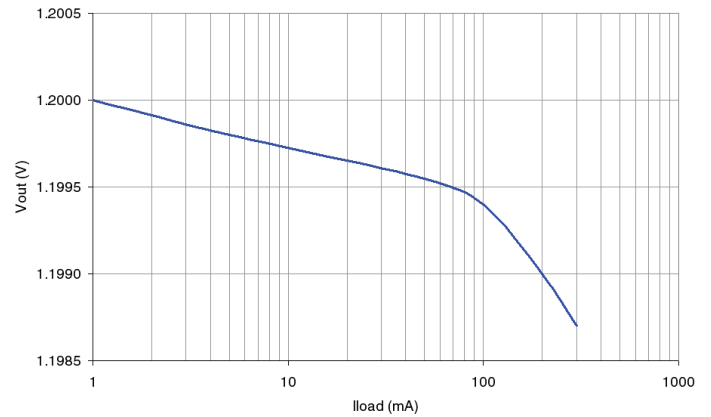

LDO2 - VIN = 1.7V - VOUT = 1.2V
Static Load Regulation - 0 To 300mA

15.4 LDO3

Unless otherwise noted, the reported measurement were performed at room temperature. External components are those described in Section 5. "Application Block Diagram" on page 8.

Figure 15-12. LDO3 Transient and Static Load Regulation Performance

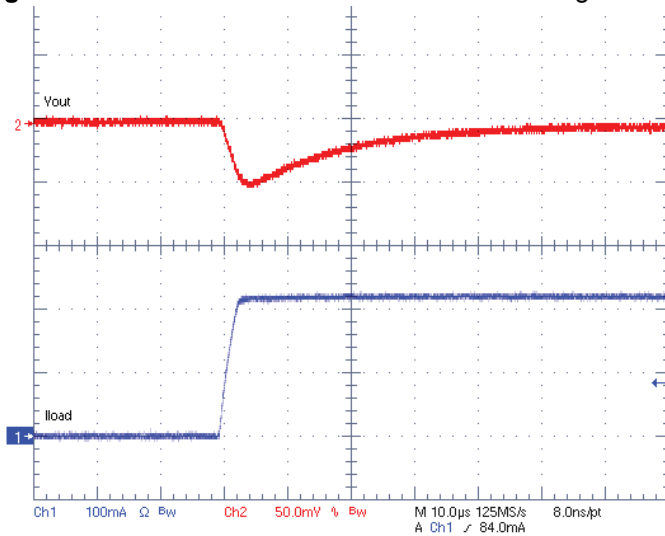

LDO3- VIN = 5.5V - VDD3 = 3.3V
Load Step 0 To 200mA / 1us

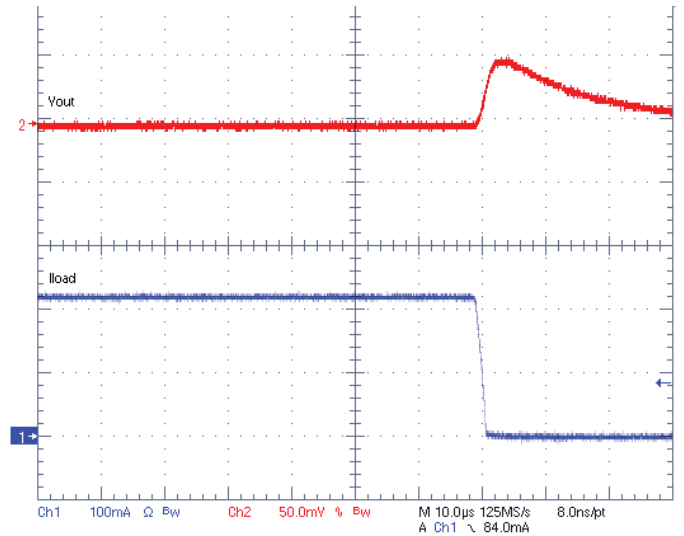

LDO3 - VIN = 5.5V - VDD3 = 3.3V
Load Step 200 To 0mA / 1us

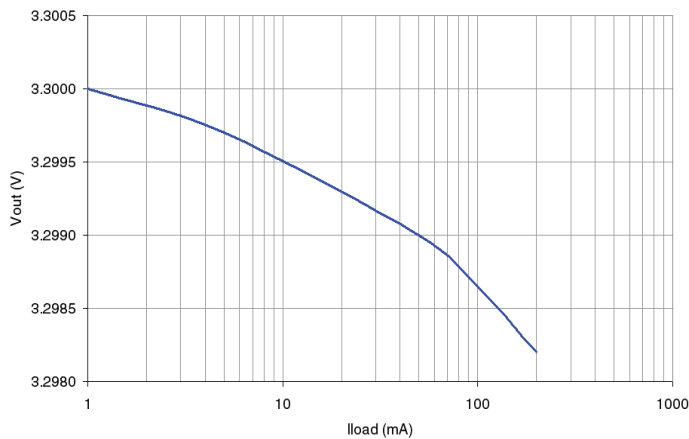

LDO3 - VIN = 3.6V - VDD3 = 3.3V
Static Load Regulation - 0 To 200mA

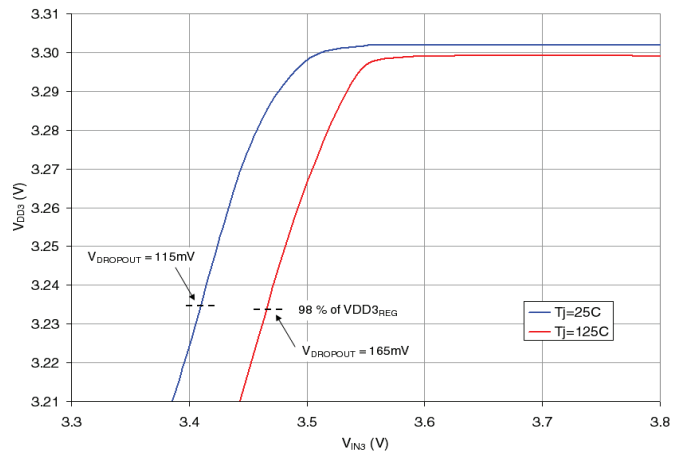

LDO3 - VDD3 = 3.3V - 200mA output load
Drop Out Characteristic.
(VDD3_{REG} = VDD3 with VIN3 > VDD3 + 300mV)

15.5 AUDIO

Unless otherwise noted, the reported measurement were performed at room temperature with AVDD = 3.3V supplied from LDO4. Typical components as described in [Section 5. "Application Block Diagram" on page 8](#) are used.

Figure 15-13. Microphone Recording Waveforms

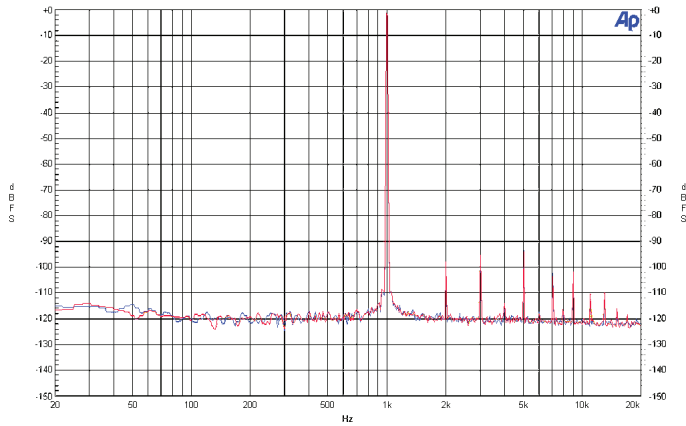

Differential Microphone Recording (Path 5)
-1dBV / 1kHz Input - Fs = 48kHz - 16kpts FFT

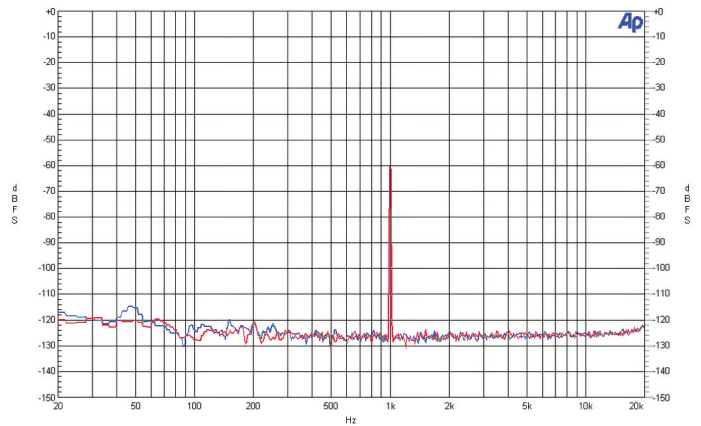

Differential Microphone Recording (Path 5)
-60dBV / 1kHz Input - Fs = 48kHz - 16kpts FFT

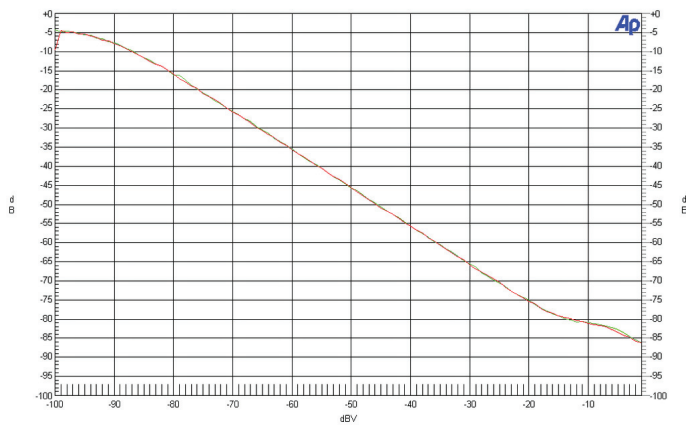

Differential Microphone Recording (Path 5)
THD+N Ratio Versus Input Level

Figure 15-14. DAC Playback Waveforms

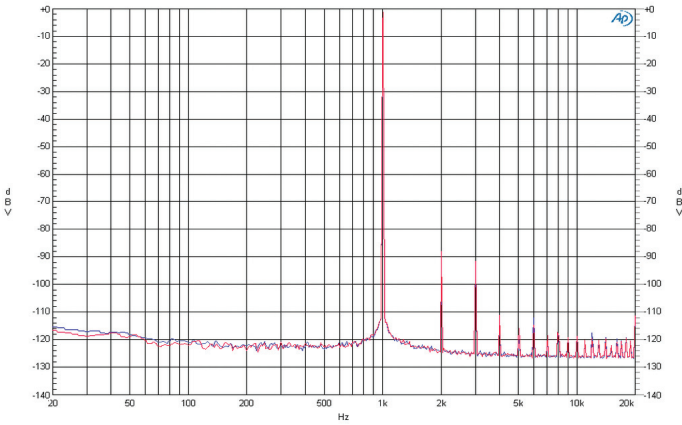

DAC playback (Path 1) - Load 10k
0 dBFs / 1kHz Input - Fs = 48kHz - 32kpts FFT

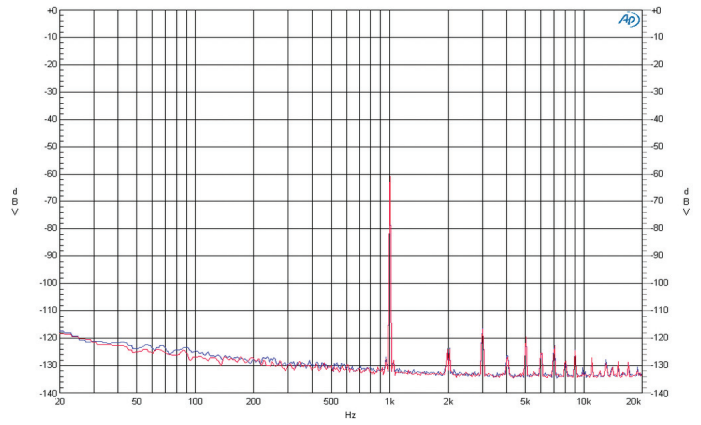

DAC playback (Path 1) - Load 10k
-60 dBFs / 1kHz Input - Fs = 48kHz - 32kpts FFT

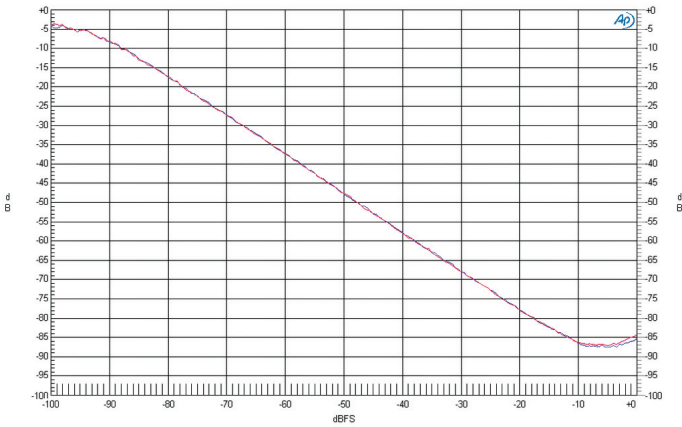

DAC playback (Path 1) - Load 10k
THD+N Ratio Versus Input Level

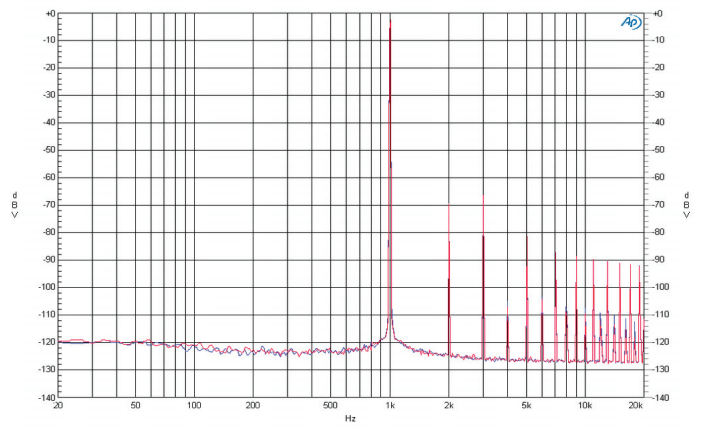

DAC playback (Path 1) - Load 32 Ohms AC coupled
20mW Ouput Power - Fs = 48kHz - 32kpts FFT

Figure 15-15. Line Record Waveforms

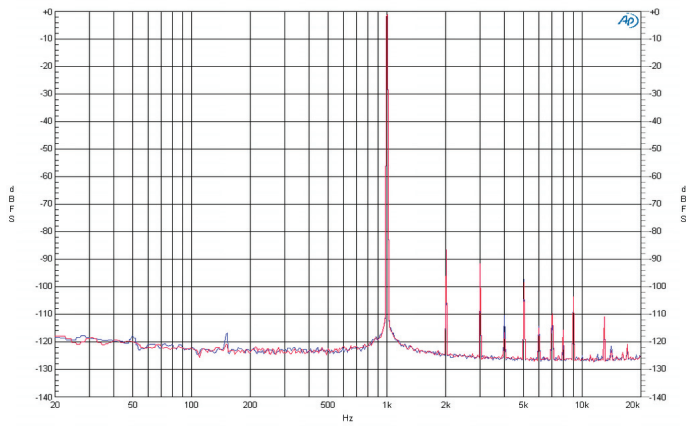

Line Record (path 7)
-1 dBV / 1kHz Input - $F_s = 48\text{kHz}$ - 32kpts FFT

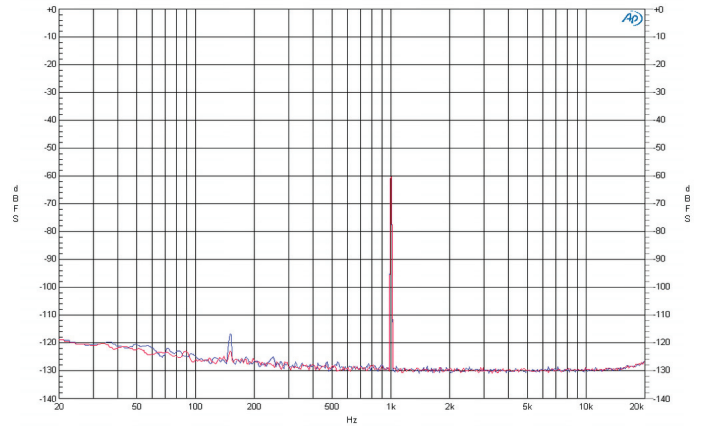

Line Record (path 7)
-60 dBV / 1kHz Input - $F_s = 48\text{kHz}$ - 32kpts FFT

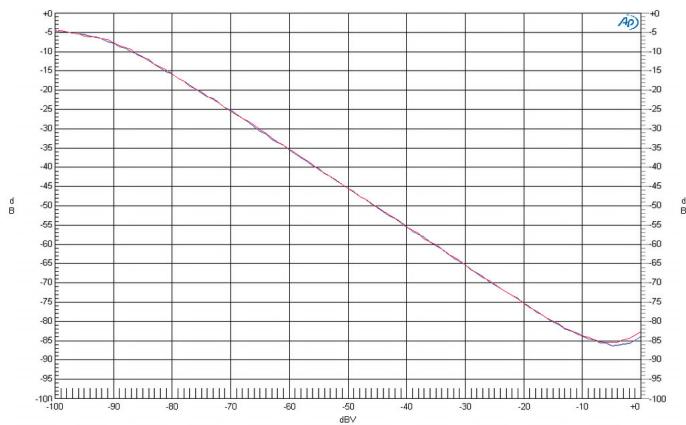

Line Record (path 7)
THD+N Ratio Versus Input Level

Figure 15-16. Line Bypass Waveforms

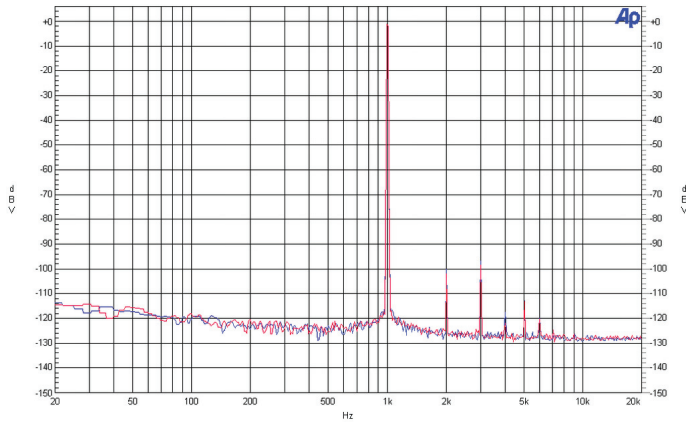

Line Bypass (path 5)
0 dBV / 1kHz Input - 10k load - 16kpts FFT

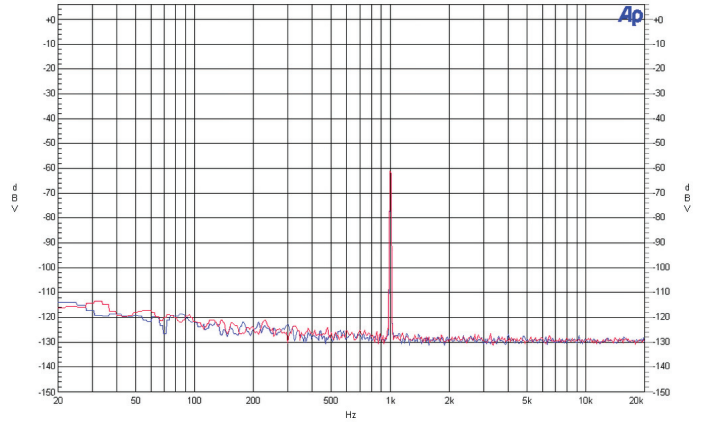

Line Bypass (path 5)
-60 dBV / 1kHz Input - 10k load - 16kpts FFT



Line Record (path 5) - 10k load
THD+N Ratio Versus Input Level

16. Package Information

Figure 16-1. Mechanical Package Drawing for 64-lead Quad Flat No Lead Package

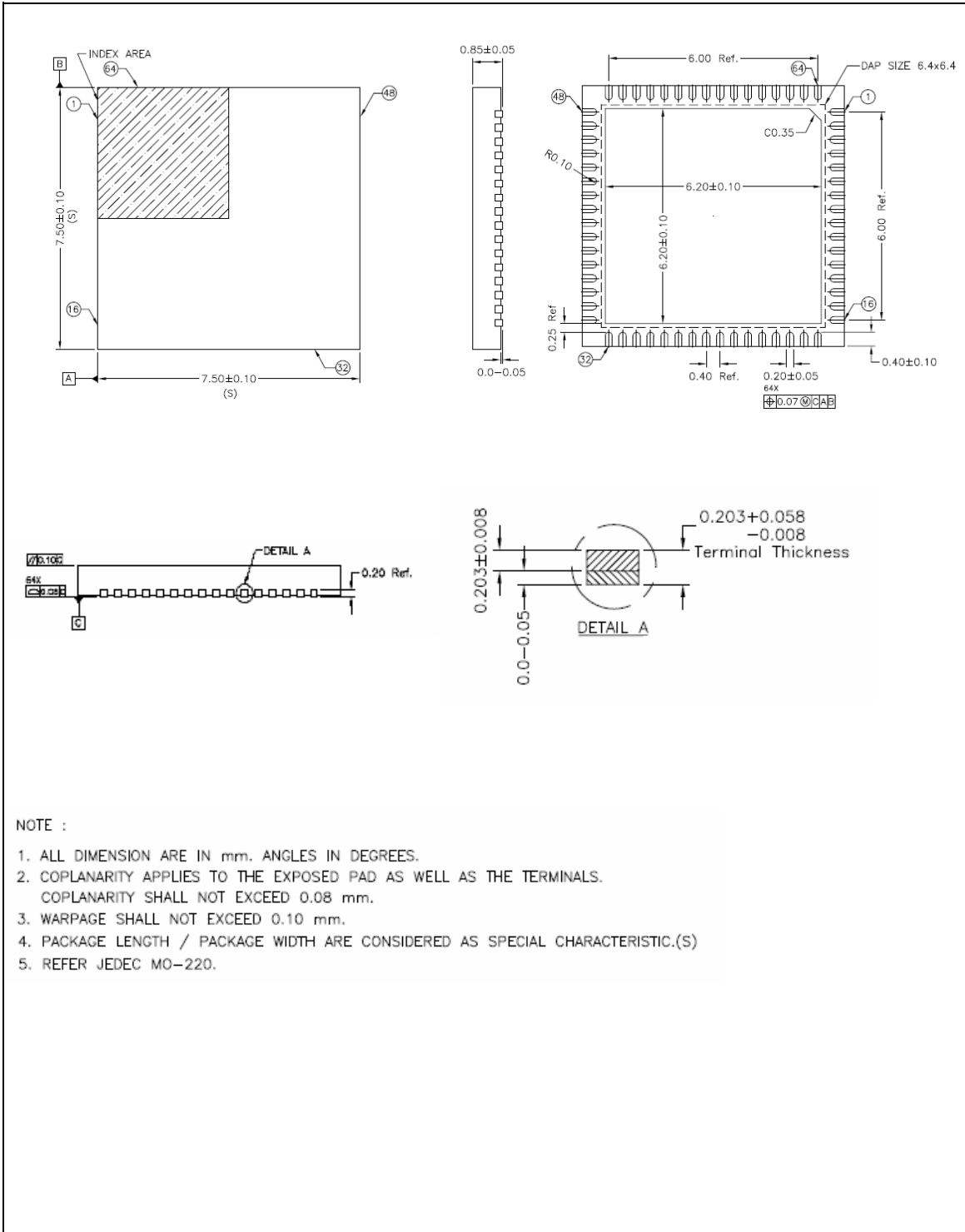

17. Ordering Information

Table 17-1. Ordering Information

Ordering Code and Marking	Package	Temperature Operating Range	Supplies Default Values	Power Sequence Type ⁽²⁾	Software Tag ⁽¹⁾
AT73C246	QFN64 7.5 x7.5mm Green	-40°C to +85°C	VDD0 = 1.85V VDD1 = 1.20V VDD2 = 1.00V VDD3 = 3.30V VDD4 = 3.30V	A	0000
AT73C246-A	QFN64 7.5 x7.5mm Green	-40°C to +85°C	VDD0 = 1.80V VDD1 = 1.20V VDD2 = 1.20V VDD3 = 3.30V VDD4 = 3.30V	B	0001
AT73C246-B	QFN64 7.5 x7.5mm Green	-40°C to +85°C	VDD0 = 1.80V VDD1 = 1.00V VDD2 = 1.00V VDD3 = 3.30V VDD4 = 3.30V	B	0010

- Notes:
1. See "VERSION" (0x7F) register definition.
 2. See "[Power Manager State Description](#)" on page 29 and "[Typical Performance Characteristics](#)" on page 139.

18. Revision History

Table 18-1. Revision History

Doc. Rev	Date	Comments	Change Request Ref.
11050A	07-Apr-10	First issue	

1	Description	2
2	Block Diagram	3
3	Package and Pinout	4
4	Pin Description	5
5	Application Block Diagram	8
6	Absolute Maximum Ratings	11
7	Recommended Operating Conditions	11
8	Power Dissipation Ratings	11
9	PMU Electrical Characteristics	12
	9.1 Current Consumption Versus Modes	12
	9.2 Supply Monitor Thresholds	12
	9.3 Digital I/Os DC Characteristics	13
	9.4 DCDC0 and DCDC1	14
	9.5 LDO2	16
	9.6 LDO3	17
	9.7 LDO4	18
	9.8 LDO5	19
	9.9 Measurement Bridge and 10-bit ADC	20
	9.10 RTC Crystal Oscillator	21
	9.11 Die Temperature Sensor	21
10	Audio Codec Electrical Characteristics	22
11	PMU Functional Description	25
	11.1 Power Manager State Diagram	25
	11.2 PMU Startup and Shutdown State Diagram	26
	11.3 Power Manager Conditional Transitions	27
	11.4 Power Manager State Description	29
	11.5 DCDC0 and DCDC1 Functional Description	36
	11.6 LDO2 Functional Description	37
	11.7 LDO3 and LDO4 Functional Description	37
	11.8 Power Fail Detectors	38
	11.9 Measurement Bridge and 10-bit ADC	38
	11.10 Real Time Clock (RTC) User Interface	40
	11.11 Die Temperature Sensor	54

12	<i>Audio Codec Functional Description</i>	55
12.1	Description	55
12.2	Audio Codec Block Diagram	55
12.3	Audio Codec Controls	56
12.4	Audio Controller	57
12.5	Audio Codec Power Consumption Versus Programmed Audio Path	63
12.6	Digital Audio Interface	66
12.7	Digital Filters Transfer Function	68
12.8	Analog Audio Interfaces	74
13	<i>Two Wire Interface and Control Registers</i>	77
13.1	Two-wire Interface (TWI) Protocol	77
13.2	PMU Register Tables	79
14	<i>PMU and Audio Soft Control: Quick Start</i>	132
14.1	RTC Examples	132
14.2	Audio Examples	134
15	<i>Typical Performance Characteristics</i>	139
15.1	PMU: Power Supply Sequences	139
15.2	DCDC0 and DCDC1	142
15.3	LDO2	146
15.4	LDO3	147
15.5	AUDIO	148
16	<i>Package Information</i>	153
17	<i>Ordering Information</i>	154
18	<i>Revision History</i>	155



Headquarters

Atmel Corporation
2325 Orchard Parkway
San Jose, CA 95131
USA
Tel: 1(408) 441-0311
Fax: 1(408) 487-2600

International

Atmel Asia
Room 1219
Chinachem Golden Plaza
77 Mody Road Tsimshatsui
East Kowloon
Hong Kong
Tel: (852) 2721-9778
Fax: (852) 2722-1369

Atmel Europe
Le Krebs
8, Rue Jean-Pierre Timbaud
BP 309
78054 Saint-Quentin-en-
Yvelines Cedex
France
Tel: (33) 1-30-60-70-00
Fax: (33) 1-30-60-71-11

Atmel Japan
9F, Tonetsu Shinkawa Bldg.
1-24-8 Shinkawa
Chuo-ku, Tokyo 104-0033
Japan
Tel: (81) 3-3523-3551
Fax: (81) 3-3523-7581

Product Contact

Web Site
www.atmel.com
www.atmel.com/PowerManage

Technical Support
pmaac@atmel.com
Atmel Technical Support

Sales Contacts
www.atmel.com/contacts/

Literature Requests
www.atmel.com/literature

Disclaimer: The information in this document is provided in connection with Atmel products. No license, express or implied, by estoppel or otherwise, to any intellectual property right is granted by this document or in connection with the sale of Atmel products. **EXCEPT AS SET FORTH IN ATMEL'S TERMS AND CONDITIONS OF SALE LOCATED ON ATMEL'S WEB SITE, ATMEL ASSUMES NO LIABILITY WHATSOEVER AND DISCLAIMS ANY EXPRESS, IMPLIED OR STATUTORY WARRANTY RELATING TO ITS PRODUCTS INCLUDING, BUT NOT LIMITED TO, THE IMPLIED WARRANTY OF MERCHANTABILITY, FITNESS FOR A PARTICULAR PURPOSE, OR NON-INFRINGEMENT. IN NO EVENT SHALL ATMEL BE LIABLE FOR ANY DIRECT, INDIRECT, CONSEQUENTIAL, PUNITIVE, SPECIAL OR INCIDENTAL DAMAGES (INCLUDING, WITHOUT LIMITATION, DAMAGES FOR LOSS OF PROFITS, BUSINESS INTERRUPTION, OR LOSS OF INFORMATION) ARISING OUT OF THE USE OR INABILITY TO USE THIS DOCUMENT, EVEN IF ATMEL HAS BEEN ADVISED OF THE POSSIBILITY OF SUCH DAMAGES.** Atmel makes no representations or warranties with respect to the accuracy or completeness of the contents of this document and reserves the right to make changes to specifications and product descriptions at any time without notice. Atmel does not make any commitment to update the information contained herein. Unless specifically provided otherwise, Atmel products are not suitable for, and shall not be used in, automotive applications. Atmel's products are not intended, authorized, or warranted for use as components in applications intended to support or sustain life.

© 2010 Atmel Corporation. All rights reserved. Atmel®, logo and combinations thereof and others, are registered trademarks or trademarks of Atmel Corporation or its subsidiaries. Other terms and product names may be trademarks of others.