

Features

- Full TCG/TCPA V1.1b Compatibility
- Single Chip Turnkey Solution
- Hardware Asymmetric Crypto Engine
- 2048 RSA Sign in 500 ms Using CRT
- AVR 8-bit RISC Microprocessor
- Internal EEPROM Storage for 10+ RSA Keys
- 33 MHz LPC (Low Pin Count) Bus for Easy PC Interface
- 100 KHz System Management Bus (SMBus) Two-wire Interface
- Secure Hardware and Firmware Design and Chip Layout
- True Random Number Generator (RNG)
- Secure Real-time Clock Option
- 3.3V $\pm 10\%$ Supply Voltage
- 28-lead TSSOP Package or 40-lead MLF Package
- 0–70°C Temperature Range

Description

The AT97SC3201 is a fully integrated security module designed to be integrated into personal computers and other embedded systems. It implements version 1.1b of the Trusted Computing Platform Alliance (TCPA) specification for Trusted Platform Modules (TPM). This specification has been adopted by the Trusted Computing Group (TCG).

The TPM includes a crypto accelerator capable of computing a 2048-bit RSA signature in 500 ms and a 1024-bit RSA signature in 100 ms, both using CRT. Communication to and from the TPM can occur through one of two interface protocols: either a 33-MHz LPC interface or a 100-KHz SMBus two-wire interface.

Figure 1. AT97SC3201 Block Diagram

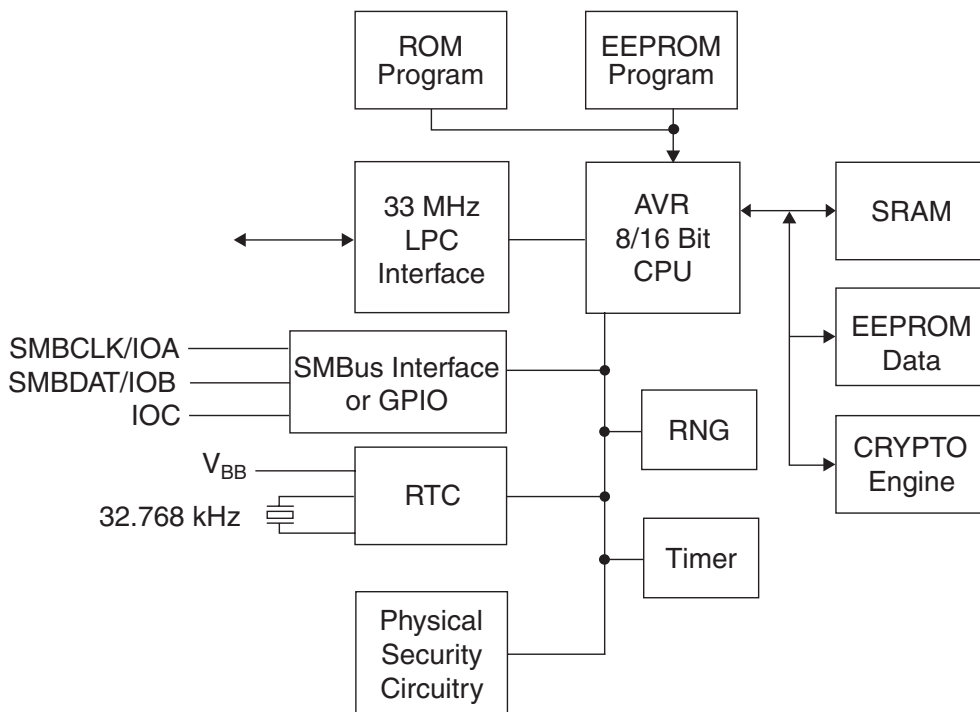

The chip includes a full hardware random number generator that is used for the TCG protocol and is also available to the system for any random numbers it may need during normal operation.

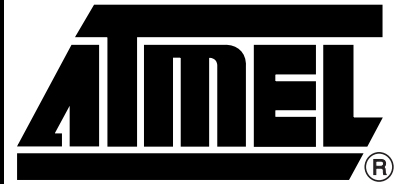

Trusted Platform Module

AT97SC3201

Summary

Rev. 2015DS-TPM-7/04



Note: This is a summary document. A complete document is available under NDA. For more information, please contact your local Atmel sales office.



A real-time clock function is available using an external battery and crystal. The chip provides tamper detection if the battery or crystal are removed or tampered with, and the current time value can be signed by the appropriate internal keys to verify its accuracy. (Contact Atmel for current status of this option.)

The battery detector can be used without the crystal for lower cost. In this mode, the TPM can indicate to the system if it has been removed from the PC in any way and can also take actions internally.

The chip uses a dynamic internal memory management scheme to store from 10 to 20 keys. Other than the standard TCG commands (TPM_Evictkey, TPM_Loadkey), no system intervention is required to manage this internal key cache.

The TPM is offered to OEM manufacturers as a turnkey solution, including the firmware integrated on the chip. In addition, Atmel provides the necessary driver software for integration into certain operating systems, along with BIOS drivers. A TCG Software Stack (TSS), also supplied by Atmel and available under license, provides communication support to any application using MSCAPI or PKCS #11 Cryptographic APIs. (Contact Atmel for a complete list of operating systems supported.)

Full documentation for TCG primitives can be found on the TCG Web site, www.trustedcomputinggroup.org. This specification includes only mechanical and electrical information.

Absolute Maximum Ratings

Operating Temperature.....	0°C to +70°C
Storage Temperature (without Bias).....	0°C to + 70°C
Voltage on I/O Pins.....	-0.1 to V _{CC} +0.3V
Voltage on VCC with Respect to Ground.....	6.0V
Maximum ESD Voltage.....	2000V

*NOTICE: Stresses beyond those listed under “Absolute Maximum Ratings” may cause permanent damage to the device. This is a stress rating only and functional operation of the device at these or any other conditions beyond those indicated in the operational sections of this specification may cause temporary or permanent failure. Exposure to absolute maximum rating conditions for extended periods may affect device reliability.

Table 1. DC Parameters*

Symbol	Parameter	Min	Nom	Max	Units	Notes
V _{CC}	Supply Voltage	3.0	3.3	3.6	V	
I _{CC}	Operating Current at fclk = 33 MHz		25	50	mA	
I _{ST}	Static Current		5	10	mA	V _{CC} = 3.6V; fxtal = 0 Hz, active inputs
I _{SL}	Sleep Current, Chip Idle		40	100	μA	V _{CC} = 3.6V; fxtal = 0 Hz
I _{BB}	Battery Current		2	4	μA	V _{CC} = 0V; fxtal = 0 Hz.
I _{LIO}	Input Leakage		0.1	3	μA	Vin = V _{CC} or GND
V _{IH}	Input High Threshold	0.5 * V _{CC}		V _{CC} + 0.5	V	
V _{IL}	Input Low Threshold	-0.5		0.3 * V _{CC}	V	
V _{OH}	Output High Voltage	0.9 * V _{CC}	0.98 * V _{CC}		V	At I _{OUT} = -500 uA
V _{OL}	Output Low Voltage			0.1 * V _{CC}	V	At I _{OUT} = 1.5mA
I _{OLCR}	Output Low Current, CLKRUN#	7			mA	At V _{OUT} = .615 * V _{CC}
C _I	Input Pin Capacitance		6		pF	Note 1

* V_{CC} = 3.0 to 3.6V; Temperature = 0 to 70°C

Note: These parameters guaranteed but not tested.



Table 2. AC Parameters*

Symbol	Parameter	Min	Nom	Max	Units	Notes
T _{VAL}	CLK to Signal Valid Delay – LAD0-3	2	5	11	ns	Measured at V _{trise} = 0.285 * V _{CC} and V _{fal} = 0.615 * V _{CC} . Measured from clk at V _{test} = 0.4 * V _{CC} ; Load = 200Ω
T _{ON}	Float to Active Delay	2	4		ns	
T _{OFF}	Active to Float Delay			28	ns	
T _{SU}	Input Setup Time to CLK	7	2		ns	
T _H	Input Hold Time from CLK	0	-500		ns	
T _{RST}	Reset Active Time after Power Stable	1			ms	Note 2
T _{RST-CLK}	Reset Active after CLK Stable	100			m	Note 2
T _{RST-OFF}	Reset Active to Output Float Delay			40	ns	Note 2
T _{CLKIN}	CLK Period	29.5	30	31	ns	Note 3
T _{CLKLO}	CLK Low Duration	13.4		18	ns	Note 1, Note 3
T _{CLKHI}	CLK High Duration	13.4		18	ns	Note 1, Note 3

* CI = 10pf. V_{CC} = 3.0 to 3.7V; Temperature = 0 to 70°C

- Note:
1. All parameters measured with respect to signal crossing V_{test} = 0.4 * V_{CC} unless otherwise noted.
 2. These parameters guaranteed but not tested.
 3. The minimum parameter must never be violated under any circumstances unless I_{reset#} is asserted. If proper CLKRUN# signaling is observed, the maximum specification can be violated.

Table 3. Ordering Information

Ordering Code	Package		Operation Range
AT97SC3201-01AC	28A3		Commercial (0° to 70° C)
AT97SC3201-X1AC	28A3	lead-free	Commercial (0° to 70° C)
AT97SC3201-01MC	40ML1		Commercial (0° to 70° C)
AT97SC3201-X1MC	40ML1	lead-free	Commercial (0° to 70° C)

Package Drawing

28A3 – TSSOP

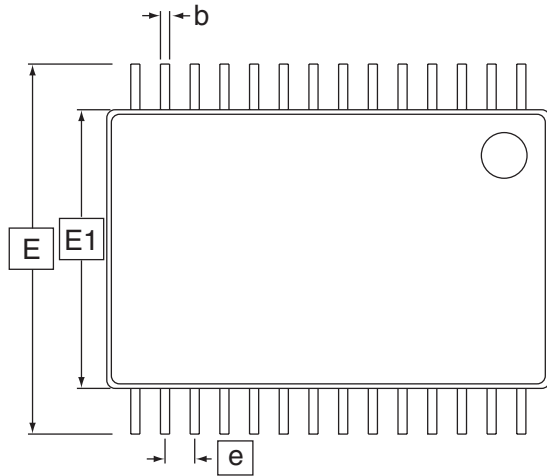

Top View

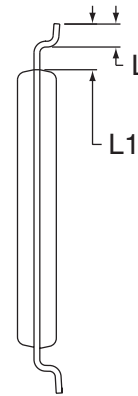

End View

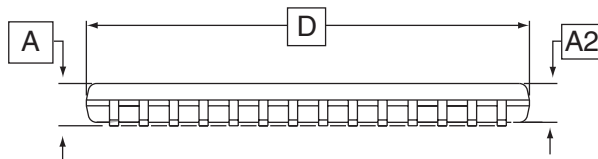

Side View

COMMON DIMENSIONS (Unit of Measure = mm)

SYMBOL	MIN	NOM	MAX	NOTE
D	9.60	9.70	9.80	2, 5
E	8.10 BSC			
E1	6.00	6.10	6.20	3, 5
A	–	–	1.20	
A2	0.80	1.00	1.05	
b	0.19	–	0.30	4
e	0.65 BSC			
L	0.45	0.60	0.75	
L1	1.00 REF			

- Notes:
1. This drawing is for general information only. Please refer to JEDEC Drawing MO-153, Variation DB for additional information.
 2. Dimension D does not include mold Flash, protrusions or gate burrs. Mold Flash, protrusions and gate burrs shall not exceed 0.15 mm (0.006 in) per side.
 3. Dimension E1 does not include inter-lead Flash or protrusions. Inter-lead Flash and protrusions shall not exceed 0.25 mm (0.010 in) per side.
 4. Dimension b does not include Dambar protrusion. Allowable Dambar protrusion shall be 0.08 mm total in excess of the b dimension at maximum material condition. Dambar cannot be located on the lower radius of the foot. Minimum space between protrusion and adjacent lead is 0.07 mm.
 5. Dimension D and E1 to be determined at Datum Plane H.

1/8/02



2325 Orchard Parkway
San Jose, CA 95131

TITLE

28A3, 28-lead, 6.1 x 9.7 mm Body, 0.65 pitch,
Thin Shrink Small Outline Package (TSSOP)

DRAWING NO.

28A3

REV.

A



40ML1

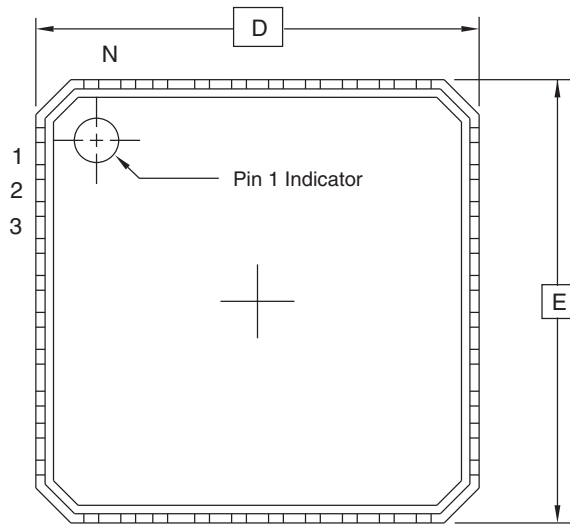

Top View

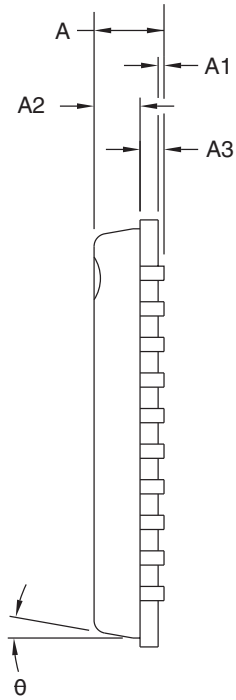

Side View

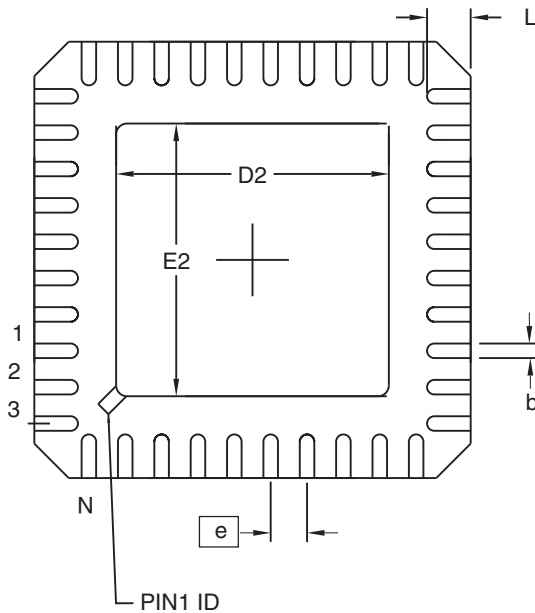

Bottom View

COMMON DIMENSIONS
(Unit of Measure = mm)

SYMBOL	MIN	NOM	MAX	NOTE
D		6.00 BSC		
E		6.00 BSC		
D2	3.95	4.10	4.25	
E2	3.95	4.10	4.25	
A	-	0.85	0.90	
A1	0.0	0.01	0.05	
A2	-	0.65	0.70	
A3		0.20 REF		
L	0.30	0.40	0.50	
e		0.50 BSC		
b	0.18	0.23	0.30	2

- Notes:
1. This drawing is for general information only. Refer to JEDEC Drawing MO-220, Variation WJJD-2, for proper dimensions, tolerances, datums, etc.
 2. Dimension b applies to metallized terminal and is measured between 0.15 mm and 0.30 mm from the terminal tip. If the terminal has the optional radius on the other end of the terminal, the dimension should not be measured in that radius area.

3/9/04



Atmel Headquarters

Corporate Headquarters

2325 Orchard Parkway
San Jose, CA 95131
TEL 1(408) 441-0311
FAX 1(408) 487-2600

Europe

Atmel Sarl
Route des Arsenaux 41
Case Postale 80
CH-1705 Fribourg
Switzerland
TEL (41) 26-426-5555
FAX (41) 26-426-5500

Asia

Room 1219
Chinachem Golden Plaza
77 Mody Road Tsimhatsui
East Kowloon
Hong Kong
TEL (852) 2721-9778
FAX (852) 2722-1369

Japan

9F, Tonetsu Shinkawa Bldg.
1-24-8 Shinkawa
Chuo-ku, Tokyo 104-0033
Japan
TEL (81) 3-3523-3551
FAX (81) 3-3523-7581

Atmel Operations

Memory

2325 Orchard Parkway
San Jose, CA 95131
TEL 1(408) 441-0311
FAX 1(408) 436-4314

Microcontrollers

2325 Orchard Parkway
San Jose, CA 95131
TEL 1(408) 441-0311
FAX 1(408) 436-4314

La Chantrerie
BP 70602
44306 Nantes Cedex 3, France
TEL (33) 2-40-18-18-18
FAX (33) 2-40-18-19-60

ASIC/ASSP/Smart Cards

Zone Industrielle
13106 Rousset Cedex, France
TEL (33) 4-42-53-60-00
FAX (33) 4-42-53-60-01

1150 East Cheyenne Mtn. Blvd.
Colorado Springs, CO 80906
TEL 1(719) 576-3300
FAX 1(719) 540-1759

Scottish Enterprise Technology Park
Maxwell Building
East Kilbride G75 0QR, Scotland
TEL (44) 1355-803-000
FAX (44) 1355-242-743

RF/Automotive

Theresienstrasse 2
Postfach 3535
74025 Heilbronn, Germany
TEL (49) 71-31-67-0
FAX (49) 71-31-67-2340

1150 East Cheyenne Mtn. Blvd.
Colorado Springs, CO 80906
TEL 1(719) 576-3300
FAX 1(719) 540-1759

Biometrics/Imaging/Hi-Rel MPU/ High Speed Converters/RF Datacom

Avenue de Rochepleine
BP 123
38521 Saint-Egreve Cedex, France
TEL (33) 4-76-58-30-00
FAX (33) 4-76-58-34-80

e-mail

literature@atmel.com

Web Site

<http://www.atmel.com>

© Atmel Corporation 2004.

Atmel Corporation makes no warranty for the use of its products, other than those expressly contained in the Company's standard warranty which is detailed in Atmel's Terms and Conditions located on the Company's web site. The Company assumes no responsibility for any errors which may appear in this document, reserves the right to change devices or specifications detailed herein at any time without notice, and does not make any commitment to update the information contained herein. No licenses to patents or other intellectual property of Atmel are granted by the Company in connection with the sale of Atmel products, expressly or by implication. Atmel's products are not authorized for use as critical components in life support devices or systems.

ATMEL® is the registered trademark of Atmel Corporation.

Other terms and product names may be the trademark of others.



Printed on recycled paper.

2015DS-TPM-7/04