

ATF-331M4

Low Noise Pseudomorphic HEMT
in a Miniature Leadless Package



Data Sheet

Description

Avago Technologies's ATF-331M4 is a high linearity, low noise pHEMT housed in a miniature leadless package.

The ATF-331M4's small size and low profile makes it ideal for the design of hybrid modules and other space-constraint devices.

Based on its featured performance, ATF-331M4 is ideal for the first or second stage of base station LNA due to the excellent combination of low noise figure and enhanced linearity[1]. The device is also suitable for applications in Wireless LAN, WLL/RLL, MMDS, and other systems requiring super low noise figure with good intercept in the 450 MHz to 10 GHz frequency range.

Note:

1. From the same PHEMT FET family, the smaller geometry ATF-34143 may also be considered for the higher gain performance, particularly in the higher frequency band (1.8 GHz and up).

MiniPak 1.4 mm x 1.2 mm Package



Pin Connections and Package Marking

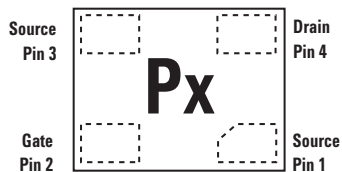

Note:

Top View. Package marking provides orientation, product identification and date code.

"P" = Device Type Code

"x" = Date code character. A different character is assigned for each month and year.

Features

- Low noise figure
- Excellent uniformity in product specifications
- 1600 micron gate width
- Miniature leadless package 1.4 mm x 1.2 mm x 0.7 mm
- Tape-and-reel packaging option available

Specifications

2 GHz; 4 V, 60 mA (Typ.)

- 0.6 dB noise figure
- 15 dB associated gain
- 19 dBm output power at 1 dB gain compression
- 31 dBm output 3rd order intercept

Applications

- Tower mounted amplifier, low noise amplifier and driver amplifier for GSM/TDMA/CDMA base stations
- LNA for WLAN, WLL/RLL, MMDS and wireless data infrastructures
- General purpose discrete PHEMT for other ultra low noise applications

ATF-331M4 Absolute Maximum Ratings^[1]

Symbol	Parameter	Units	Absolute Maximum
V_{DS}	Drain-Source Voltage ^[2]	V	5.5
V_{GS}	Gate-Source Voltage ^[2]	V	-5
V_{GD}	Gate Drain Voltage ^[2]	V	-5
I_{DS}	Drain Current ^[2]	mA	I_{diss} ^[3]
P_{diss}	Total Power Dissipation ^[4]	mW	400
$P_{in\ max.}$	RF Input Power	dBm	20
T_{CH}	Channel Temperature ^[5]	°C	160
T_{STG}	Storage Temperature	°C	-65 to 160
θ_{jc}	Thermal Resistance ^[6]	°C/W	200

Notes:

1. Operation of this device above any one of these parameters may cause permanent damage.
2. Assumes DC quiescent conditions.
3. $V_{GS} = 0V$
4. Source lead temperature is 25°C. Derate 5 mW/°C for $T_L > 40^\circ C$.
5. Please refer to failure rates in reliability data sheet to assess the reliability impact of running devices above a channel temperature of 140°C.
6. Thermal resistance measured using 150°C Liquid Crystal Measurement method.

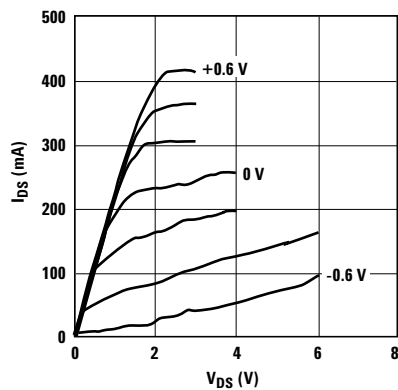

Figure 1. Typical Pulsed I-V Curves^[7].
($V_{GS} = -0.2V$ per step)

Note:

7. Under large signal conditions, V_{GS} may swing positive and the drain current may exceed I_{dss} . These conditions are acceptable as long as the Maximum P_{diss} and $P_{in\ max}$ ratings are not exceeded.

Product Consistency Distribution Charts^[8, 9]

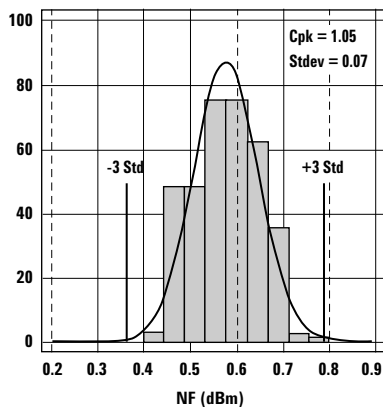

Figure 2. NF @ 2 GHz, 4 V, 60 mA.
LSL = 28.5, Nominal = 0.6, USL = 0.8.

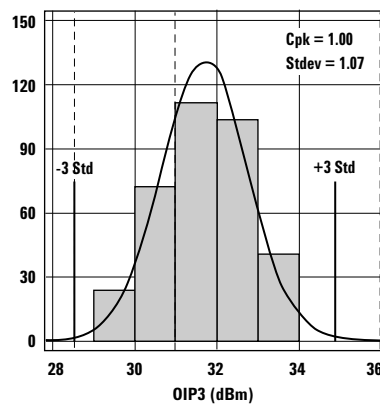

Figure 3. OIP3 @ 2 GHz, 4 V, 60 mA.
LSL = 28.5, Nominal = 31.0, USL = 36.0

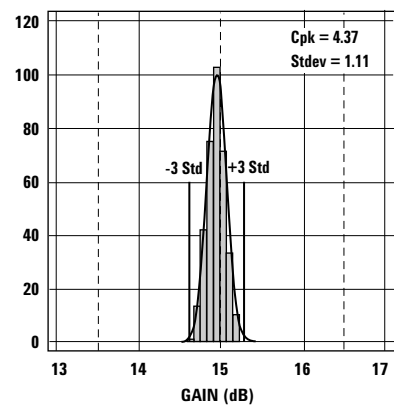

Figure 4. Gain @ 2 GHz, 4 V, 60 mA.
LSL = 13.5, Nominal = 15.0, USL = 16.5

Notes:

8. Distribution data sample size is 349 samples from 4 different wafers. Future wafers allocated to this product may have nominal values anywhere within the upper and lower spec limits.
9. Measurements made on production test board. This circuit represents a trade-off between an optimal noise match and a realizable match based on production test requirements. Circuit losses have been de-embedded from actual measurements.

ATF-331M4 DC Electrical Specifications

$T_A = 25^\circ\text{C}$, RF parameters measured in a test circuit for a typical device

Symbol	Parameter and Test Condition	Units	Min.	Typ. ^[2]	Max.	
$I_{dss}^{[1]}$	Saturated Drain Current $V_{ds} = 1.5\text{ V}, V_{gs} = 0\text{ V}$	mA	175	237	305	
$V_p^{[1]}$	Pinch-off Voltage $V_{ds} = 1.5\text{ V}, I_{ds} = 10\% \text{ of } I_{dss}$	V	-0.65	-0.5	-0.35	
I_d	Quiescent Bias Current $V_{gs} = -0.51\text{ V}, V_{ds} = 4\text{ V}$	mA	—	60	—	
$G_m^{[1]}$	Transconductance $V_{ds} = 1.5\text{ V}, G_m = I_{dss}/V_p$	mmho	360	440	—	
I_{gdo}	Gate to Drain Leakage Current $V_{gd} = -5\text{ V}$	μA	—	—	1000	
I_{gss}	Gate Leakage Current $V_{gd} = V_{gs} = -4\text{ V}$	μA	—	42	600	
NF	Noise Figure	$f = 2\text{ GHz}$ $V_{ds} = 4\text{ V}, I_{ds} = 60\text{ mA}$	dB	—	0.6	0.8
		$f = 900\text{ MHz}$ $V_{ds} = 4\text{ V}, I_{ds} = 60\text{ mA}$	dB	—	0.5	—
Ga	Associated Gain	$f = 2\text{ GHz}$ $V_{ds} = 4\text{ V}, I_{ds} = 60\text{ mA}$	dB	13.5	15	16.5
		$f = 900\text{ MHz}$ $V_{ds} = 4\text{ V}, I_{ds} = 60\text{ mA}$	dB	—	21	—
OIP3	Output 3rd Order Intercept Point ^[3]	$f = 2\text{ GHz}$ 5 dBm Pout/Tone $V_{ds} = 4\text{ V}, I_{ds} = 60\text{ mA}$	dBm	28.5	31	—
		$f = 900\text{ MHz}$ 5 dBm Pout/Tone $V_{ds} = 4\text{ V}, I_{ds} = 60\text{ mA}$	dBm	—	30.8	—
P1dB	1dB Compressed Output Power ^[3]	$f = 2\text{ GHz}$ $V_{ds} = 4\text{ V}, I_{ds} = 60\text{ mA}$	dBm	—	19	—
		$f = 900\text{ MHz}$ $V_{ds} = 4\text{ V}, I_{ds} = 60\text{ mA}$	dBm	—	18	—

Notes:

1. Guaranteed at wafer probe level
2. Typical values are determined from a sample size of 349 parts from 4 wafers.
3. Measurements obtained using production test board described in Figure 5.

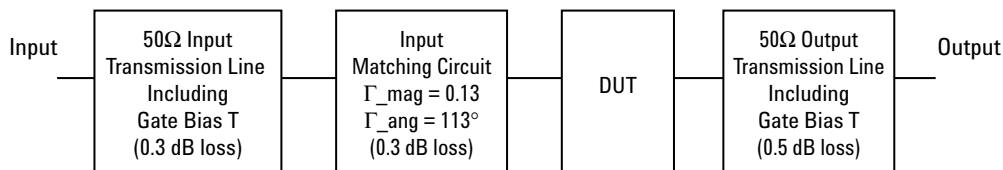

Figure 5. Block diagram of 2 GHz production test board used for Noise Figure, Associated Gain, P1dB, and OIP3 measurements. This circuit represents a trade-off between an optimal noise match and a realizable match based on production test requirements. Circuit losses have been de-embedded from actual measurements.

ATF-331M4 Typical Performance Curves

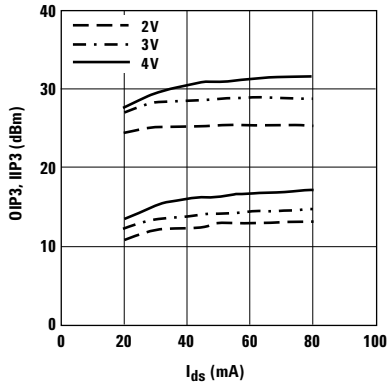

Figure 6. OIP3, IIP3 & Bias^[1] at 2 GHz.

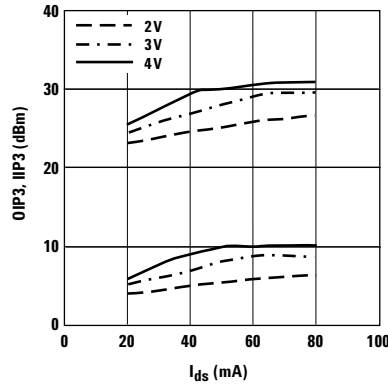

Figure 7. OIP3, IIP3 & Bias^[1] at 900 MHz.

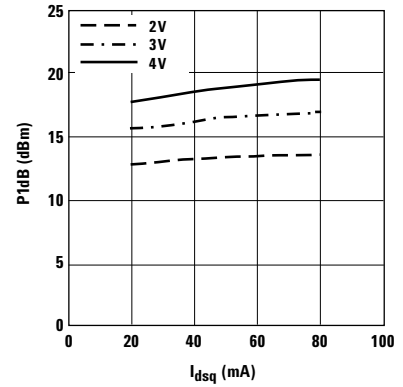

Figure 8. P1dB vs. Bias^[1,2] 2 GHz.

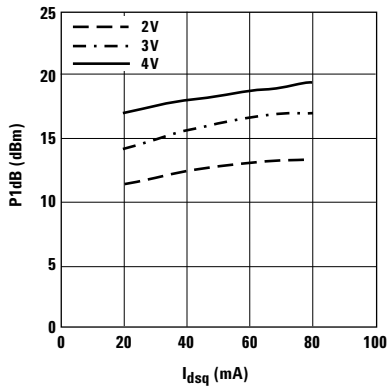

Figure 9. P1dB vs. Bias^[1] 900 MHz.

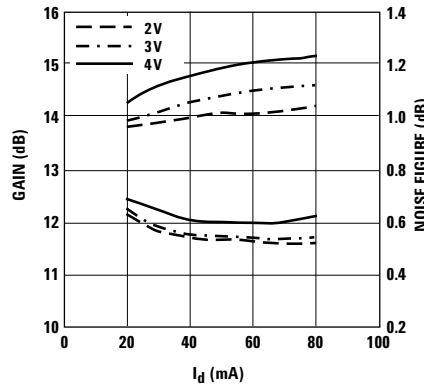

Figure 10. NF & Gain vs. Bias^[1] at 2 GHz.

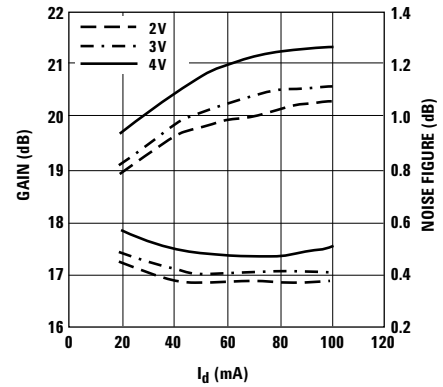

Figure 11. NF & Gain vs. Bias^[1] at 900 MHz.

Notes:

1. Measurements made on fixed tuned production test board that was tuned for optimal gain match with reasonable noise figure at 4V 60 mA bias. This circuit represents a trade-off between an optimal noise match, maximum gain match and a realizable match based on production test board requirements. Circuit losses have been de-embedded from actual measurements.
2. Quiescent drain current, I_{dsq} , is set with zero RF drive applied. As P1dB is approached, the drain current may increase or decrease depending on frequency and dc bias point. At lower values of I_{dsq} the device is running closer to class B as power output approaches P1dB. This results in higher P1dB and higher PAE (power added efficiency) when compared to a device that is driven by a constant current source as is typically done with active biasing.

ATF-331M4 Typical Performance Curves, continued

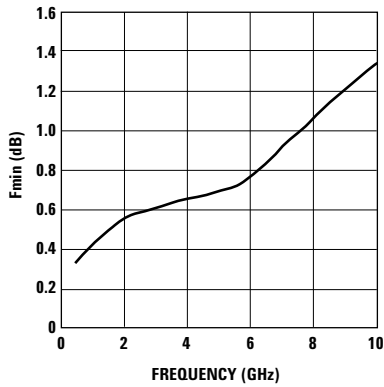

Figure 12. Fmin vs. Frequency at 4 V, 60 mA.

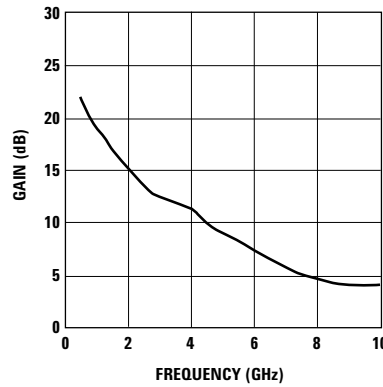

Figure 13. Associated Gain vs. Frequency at 4 V, 60 mA.

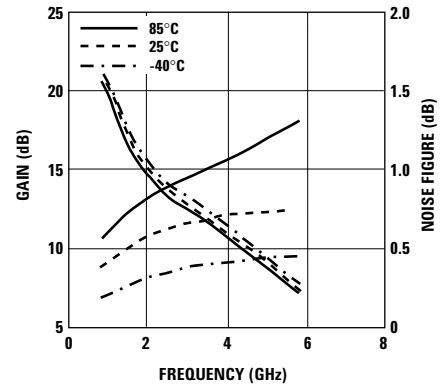

Figure 14. Fmin & Ga vs. Frequency and Temp. Vd = 4 V, Ids = 60 mA.

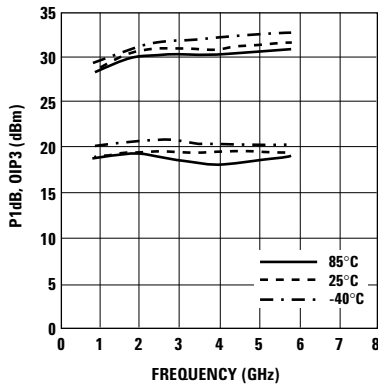

Figure 15. P1dB, OIP3 vs. Frequency and Temp at Vd = 4 V, Ids = 60 mA.

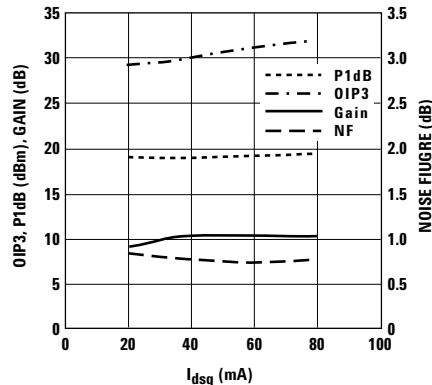

Figure 16. OIP3, P1dB, NF and Gain vs. Bias^[1,2] at 3.9 GHz.

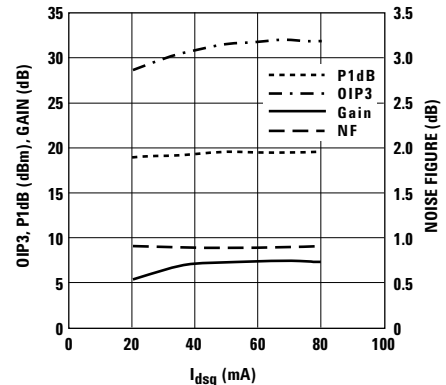

Figure 17. OIP3, P1dB, NF at 5.8 GHz.

Notes:

1. Measurements made on fixed tuned production test board that was tuned for optimal gain match with reasonable noise figure at 4V 60 mA bias. This circuit represents a trade-off between an optimal noise match, maximum gain match and a realizable match based on production test board requirements. Circuit losses have been de-embedded from actual measurements.
2. Quiescent drain current, Idsq, is set with zero RF drive applied. As P1dB is approached, the drain current may increase or decrease depending on frequency and dc bias point. At lower values of Idsq the device is running closer to class B as power output approaches P1dB. This results in higher P1dB and higher PAE (power added efficiency) when compared to a device that is driven by a constant current source as is typically done with active biasing.

ATF-331M4 Typical Scattering Parameters, $V_{DS} = 2V$, $I_{DS} = 40\text{ mA}$

Freq. GHz	S11			S21			S12		S22		MSG/MAG dB
	Mag.	Ang.	dB	Mag.	Ang.	dB	Mag.	Ang.	Mag.	Ang.	
0.5	0.82	-91.90	22.10	12.74	127.90	-27.13	0.044	53.30	0.40	-163.10	24.62
0.8	0.79	-119.10	18.85	8.76	112.80	-25.19	0.055	46.70	0.47	-169.67	22.02
1.0	0.78	-132.10	18.06	8.00	106.00	-24.44	0.060	44.70	0.49	-173.83	21.25
1.5	0.76	-151.40	14.75	5.46	93.73	-22.73	0.073	42.73	0.53	177.77	18.74
1.8	0.75	-159.60	13.55	4.76	88.20	-21.72	0.082	42.13	0.53	173.73	17.64
2.0	0.74	-163.60	13.36	4.65	85.00	-21.31	0.086	41.93	0.54	171.27	17.33
2.5	0.72	-170.70	10.33	3.29	77.97	-20.09	0.099	41.33	0.53	165.20	15.21
3.0	0.69	-174.30	9.60	3.02	71.83	-18.12	0.124	40.57	0.55	162.60	13.86
4.0	0.71	163.10	6.62	2.14	53.23	-17.20	0.138	30.30	0.56	138.03	10.77
5.0	0.73	150.00	4.98	1.77	41.60	-16.65	0.147	24.97	0.56	134.30	9.25
6.0	0.71	140.90	3.94	1.57	28.80	-16.08	0.157	17.23	0.57	115.73	7.71
7.0	0.73	123.90	2.92	1.40	14.70	-15.39	0.170	7.10	0.57	109.93	6.97
8.0	0.74	112.90	2.77	1.38	6.70	-15.04	0.177	2.57	0.58	108.90	6.98
9.0	0.76	97.70	2.60	1.35	-4.77	-14.99	0.178	-6.27	0.59	93.03	6.78
10.0	0.79	83.60	2.00	1.26	-18.20	-14.75	0.183	-17.47	0.59	78.30	6.54
11.0	0.86	61.90	0.08	1.01	-32.50	-14.80	0.182	-29.77	0.58	66.00	6.03
12.0	0.87	62.10	-0.71	0.92	-37.90	-14.33	0.192	-33.90	0.65	59.73	5.63
13.0	0.88	51.90	-1.54	0.84	-49.90	-14.89	0.180	-44.67	0.69	49.07	5.20
14.0	0.88	44.60	-2.09	0.79	-58.90	-15.44	0.169	-52.47	0.73	40.13	5.04
15.0	0.91	38.70	-4.00	0.63	-67.70	-15.81	0.162	-60.63	0.75	30.57	4.34
16.0	0.93	33.30	-5.66	0.52	-74.80	-18.71	0.116	-67.27	0.78	24.73	4.04
17.0	0.93	28.40	-5.68	0.52	-80.50	-17.86	0.128	-73.07	0.79	18.67	4.02
18.0	0.92	25.20	-6.58	0.47	-84.00	-17.99	0.126	-77.40	0.81	13.87	3.03

Typical Noise Parameters, $V_{DS} = 2V$, $I_{DS} = 40\text{ mA}$

Freq GHz	F_{min} dB	Γ_{opt} Mag.	Γ_{opt} Ang.	$R_n/50$	G_a dB
0.50	0.37	0.39	0.6	0.07	21.16
0.90	0.41	0.381	26.3	0.06	18.36
1.00	0.41	0.38	32.9	0.06	18.19
1.50	0.46	0.38	63.6	0.05	15.96
1.80	0.48	0.385	80	0.05	15.43
2.00	0.5	0.39	90.1	0.05	14.56
2.50	0.54	0.407	112.8	0.04	13.29
3.00	0.59	0.431	132	0.04	12.18
4.00	0.67	0.492	161.3	0.03	10.4
5.00	0.76	0.565	-179	0.02	8.94
6.00	0.85	0.638	-166	0.02	7.96
7.00	0.93	0.702	-156.9	0.04	7
8.00	1.02	0.747	-148.9	0.07	6.16
9.00	1.11	0.762	-139	0.11	5.8
10.00	1.19	0.737	-124.5	0.18	4.89

Notes:

1. The F_{min} values are based on a set of 16 noise figure measurements made at 16 different impedances using an ATN NP5 test system. From these measurements F_{min} is calculated. Refer to the noise parameter measurement section for more information.
2. S and noise parameters are measured on a microstrip line made on 0.010 inch thick alumina carrier assembly. The input reference plane is at the end of the gate pad. The output reference plane is at the end of the drain pad.

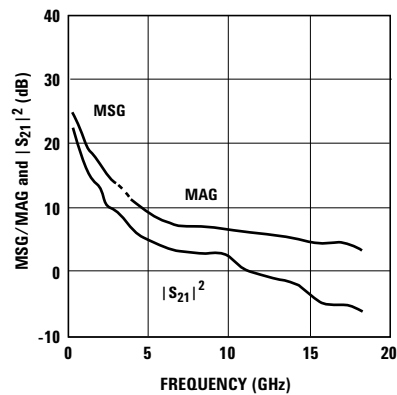

Figure 18. MSG/MAG and $|S_{21}|^2$ vs. Frequency at 2V, 40 mA.

ATF-331M4 Typical Scattering Parameters, $V_{DS} = 3V, I_{DS} = 40\text{ mA}$

Freq. GHz	S11			S21			S12		S22		MSG/MAG dB
	Mag.	Ang.	dB	Mag.	Ang.	dB	Mag.	Ang.	Mag.	Ang.	
0.5	0.82	-90.50	22.45	13.27	128.40	-27.54	0.042	53.80	0.38	-155.50	24.99
0.8	0.78	-117.70	19.31	9.24	113.30	-25.35	0.054	47.10	0.44	-165.77	22.33
1.0	0.77	-130.90	18.50	8.41	106.40	-24.58	0.059	45.10	0.46	-170.63	21.54
1.5	0.75	-150.40	15.23	5.77	93.93	-22.97	0.071	43.03	0.49	180.17	19.10
1.8	0.74	-158.70	14.02	5.02	88.30	-21.94	0.080	42.33	0.49	-184.17	17.98
2.0	0.74	-162.70	13.79	4.89	85.10	-21.51	0.084	42.13	0.50	173.27	17.65
2.5	0.72	-170.00	10.81	3.47	77.97	-20.18	0.098	41.53	0.50	166.80	15.49
3.0	0.69	-174.10	9.60	3.02	71.63	-18.24	0.122	40.67	0.52	163.70	13.92
4.0	0.71	163.70	7.13	2.27	53.03	-17.33	0.136	30.70	0.52	139.43	11.20
5.0	0.73	150.50	5.46	1.87	41.40	-16.83	0.144	25.67	0.52	136.10	9.63
6.0	0.71	141.50	4.37	1.65	28.50	-16.31	0.153	18.13	0.54	118.23	8.02
7.0	0.73	124.40	3.34	1.47	14.10	-15.55	0.167	8.10	0.54	111.83	7.28
8.0	0.74	113.40	3.14	1.44	6.00	-15.19	0.174	3.57	0.54	110.90	7.28
9.0	0.76	98.20	2.94	1.40	-5.57	-15.14	0.175	-4.97	0.55	95.33	7.05
10.0	0.79	84.10	2.33	1.31	-19.10	-14.94	0.179	-16.07	0.55	80.50	6.83
11.0	0.86	62.40	0.44	1.05	-33.40	-14.94	0.179	-28.27	0.55	67.80	6.40
12.0	0.87	62.50	-0.38	0.96	-38.90	-14.47	0.189	-32.20	0.61	61.73	6.00
13.0	0.88	52.30	-1.20	0.87	-50.90	-14.99	0.178	-42.87	0.66	50.97	5.55
14.0	0.89	44.90	-1.79	0.81	-60.20	-15.55	0.167	-50.87	0.70	41.63	5.33
15.0	0.91	39.00	-3.64	0.66	-69.10	-15.81	0.162	-59.03	0.73	32.17	4.81
16.0	0.93	33.40	-5.30	0.54	-76.40	-18.64	0.117	-65.67	0.76	26.13	4.49
17.0	0.93	28.50	-5.40	0.54	-82.40	-17.79	0.129	-71.87	0.78	19.77	4.48
18.0	0.92	25.10	-6.34	0.48	-86.10	-17.92	0.127	-76.40	0.80	14.87	3.39

Typical Noise Parameters, $V_{DS} = 3V, I_{DS} = 40\text{ mA}$

Freq GHz	F_{min} dB	Γ_{opt} Mag.	Γ_{opt} Ang.	$R_n/50$	G_a dB
0.50	0.37	0.377	0.7	0.07	21.42
0.90	0.41	0.367	24.5	0.06	18.53
1.00	0.42	0.366	31.1	0.06	18.28
1.50	0.46	0.365	61.6	0.05	15.95
1.80	0.49	0.37	77.8	0.05	15.42
2.00	0.51	0.374	87.9	0.05	14.61
2.50	0.55	0.392	110.5	0.04	13.33
3.00	0.59	0.416	129.6	0.04	12.25
4.00	0.68	0.479	159.2	0.03	10.5
5.00	0.77	0.553	179.4	0.02	9.06
6.00	0.86	0.627	-167.2	0.02	8.05
7.00	0.95	0.69	-157.6	0.04	7.13
8.00	1.04	0.733	-149.2	0.06	6.38
9.00	1.13	0.742	-139.1	0.1	5.97
10.00	1.22	0.709	-124.7	0.18	5

Notes:

1. The F_{min} values are based on a set of 16 noise figure measurements made at 16 different impedances using an ATN NP5 test system. From these measurements F_{min} is calculated. Refer to the noise parameter measurement section for more information.
2. S and noise parameters are measured on a microstrip line made on 0.010 inch thick alumina carrier assembly. The input reference plane is at the end of the gate pad. The output reference plane is at the end of the drain pad.

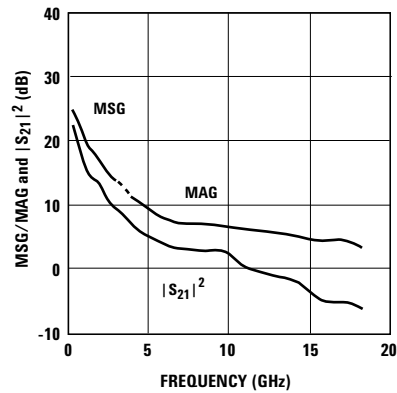

Figure 19. MSG/MAG and $|S_{21}|^2$ vs. Frequency at 3V, 40 mA.

ATF-331M4 Typical Scattering Parameters, $V_{DS} = 3V$, $I_{DS} = 60\text{ mA}$

Freq. GHz	S11			S21			S12		S22		MSG/MAG dB
	Mag.	Ang.	dB	Mag.	Ang.	dB	Mag.	Ang.	Mag.	Ang.	
0.5	0.81	-93.60	22.93	14.01	127.00	-28.64	0.037	54.00	0.39	-167.20	25.78
0.8	0.78	-120.70	19.68	9.64	112.10	-26.56	0.047	48.30	0.46	-172.07	23.12
1.0	0.77	-133.60	18.81	8.72	105.40	-25.68	0.052	46.80	0.48	-175.73	22.24
1.5	0.75	-152.50	15.50	5.96	93.43	-23.88	0.064	46.03	0.51	176.57	19.69
1.8	0.74	-160.50	14.27	5.17	88.00	-22.73	0.073	45.93	0.51	172.73	18.50
2.0	0.74	-164.40	14.02	5.02	84.80	-22.16	0.078	46.03	0.52	170.47	18.09
2.5	0.72	-171.30	11.06	3.57	77.97	-20.72	0.092	45.93	0.52	164.60	15.89
3.0	0.70	-175.30	9.80	3.09	71.93	-18.40	0.120	45.37	0.53	161.90	14.10
4.0	0.71	162.70	7.39	2.34	53.33	-17.52	0.133	35.20	0.54	137.43	11.21
5.0	0.73	149.70	5.70	1.93	41.90	-16.95	0.142	29.87	0.54	134.20	9.70
6.0	0.71	140.60	4.61	1.70	29.10	-16.31	0.153	21.73	0.55	116.23	8.18
7.0	0.73	123.70	3.54	1.50	15.10	-15.55	0.167	11.40	0.56	110.13	7.39
8.0	0.74	112.70	3.33	1.47	7.10	-15.09	0.176	6.37	0.56	109.10	7.35
9.0	0.76	97.60	3.12	1.43	-4.37	-15.04	0.177	-2.77	0.57	93.43	7.16
10.0	0.79	83.40	2.52	1.34	-17.80	-14.75	0.183	-14.27	0.57	78.70	6.95
11.0	0.86	61.80	0.66	1.08	-32.10	-14.80	0.182	-26.87	0.57	66.20	6.68
12.0	0.87	62.00	-0.15	0.98	-37.60	-14.29	0.193	-31.00	0.63	60.03	6.21
13.0	0.88	52.00	-0.96	0.90	-49.50	-14.80	0.182	-41.97	0.68	49.47	5.74
14.0	0.89	44.50	-1.56	0.84	-58.70	-15.34	0.171	-50.27	0.71	40.23	5.55
15.0	0.92	38.80	-3.38	0.68	-67.60	-15.65	0.165	-58.43	0.74	30.87	5.16
16.0	0.94	33.20	-5.04	0.56	-74.90	-18.42	0.120	-65.47	0.77	25.03	4.92
17.0	0.94	28.20	-5.15	0.55	-80.90	-17.65	0.131	-71.67	0.78	18.87	4.96
18.0	0.93	24.60	-6.11	0.50	-84.90	-17.79	0.129	-76.30	0.80	14.17	3.76

Typical Noise Parameters, $V_{DS} = 3V$, $I_{DS} = 60\text{ mA}$

Freq GHz	F_{min} dB	Γ_{opt} Mag.	Γ_{opt} Ang.	$R_n/50$	G_a dB
0.50	0.36	0.35	0.2	0.06	21.97
0.90	0.4	0.341	24.3	0.06	18.96
1.00	0.41	0.34	31.1	0.05	18.77
1.50	0.45	0.341	62.5	0.04	16.31
1.80	0.48	0.346	79.3	0.05	15.79
2.00	0.5	0.351	89.6	0.05	14.93
2.50	0.54	0.37	112.8	0.04	13.67
3.00	0.59	0.395	132.4	0.04	12.62
4.00	0.68	0.461	162.3	0.03	10.78
5.00	0.77	0.538	-177.6	0.02	9.28
6.00	0.86	0.616	-164.4	0.02	8.34
7.00	0.95	0.683	-155.3	0.04	7.37
8.00	1.04	0.729	-147.2	0.07	6.63
9.00	1.13	0.742	-137.3	0.11	6.19
10.00	1.22	0.712	-122.6	0.19	5.23

Notes:

1. The F_{min} values are based on a set of 16 noise figure measurements made at 16 different impedances using an ATN NP5 test system. From these measurements F_{min} is calculated. Refer to the noise parameter measurement section for more information.
2. S and noise parameters are measured on a microstrip line made on 0.010 inch thick alumina carrier assembly. The input reference plane is at the end of the gate pad. The output reference plane is at the end of the drain pad.

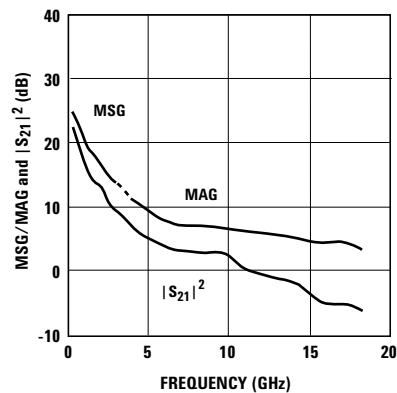

Figure 20. MSG/MAG and $|S_{21}|^2$ vs. Frequency at 3V, 60 mA.

ATF-331M4 Typical Scattering Parameters, $V_{DS} = 4V$, $I_{DS} = 40\text{ mA}$

Freq. GHz	S11			S21			S12		S22		MSG/MAG dB
	Mag.	Ang.	dB	Mag.	Ang.	dB	Mag.	Ang.	Mag.	Ang.	
0.5	0.82	-89.80	22.59	13.48	128.80	-27.54	0.042	54.00	0.36	-149.40	25.06
0.8	0.78	-116.90	19.49	9.43	113.60	-25.51	0.053	47.30	0.41	-162.57	22.50
1.0	0.77	-130.00	18.68	8.59	106.60	-24.73	0.058	45.20	0.43	-167.93	21.70
1.5	0.75	-149.70	15.42	5.90	94.13	-22.97	0.071	42.93	0.46	-177.83	19.20
1.8	0.74	-158.00	14.21	5.13	88.40	-22.05	0.079	42.23	0.46	177.53	18.13
2.0	0.74	-162.20	13.70	4.84	85.10	-21.51	0.084	41.93	0.47	174.77	17.61
2.5	0.72	-169.50	11.50	3.76	77.87	-20.26	0.097	41.33	0.48	168.10	15.88
3.0	0.69	-173.80	10.20	3.24	71.53	-18.20	0.123	40.47	0.49	164.80	14.20
4.0	0.70	164.10	7.34	2.33	52.63	-17.46	0.134	30.50	0.50	140.63	11.39
5.0	0.73	150.90	5.66	1.92	40.90	-16.95	0.142	25.67	0.50	137.60	9.81
6.0	0.71	141.80	4.54	1.69	28.00	-16.42	0.151	18.43	0.51	120.43	8.14
7.0	0.73	124.70	3.52	1.50	13.40	-15.65	0.165	8.40	0.52	113.63	7.45
8.0	0.74	113.70	3.29	1.46	5.20	-15.29	0.172	4.07	0.52	112.80	7.42
9.0	0.76	98.50	3.08	1.43	-6.37	-15.29	0.172	-4.27	0.53	97.33	7.18
10.0	0.79	84.30	2.45	1.33	-20.00	-15.04	0.177	-15.27	0.53	82.40	6.94
11.0	0.86	62.60	0.59	1.07	-34.50	-15.04	0.177	-27.37	0.53	69.40	6.64
12.0	0.87	62.70	-0.26	0.97	-40.00	-14.56	0.187	-31.00	0.59	63.63	6.29
13.0	0.88	52.60	-1.08	0.88	-52.10	-15.09	0.176	-41.67	0.64	52.57	5.80
14.0	0.89	45.10	-1.66	0.83	-61.60	-15.55	0.167	-49.77	0.69	43.13	5.59
15.0	0.92	39.20	-3.49	0.67	-70.50	-15.81	0.162	-58.03	0.71	33.47	5.35
16.0	0.94	33.50	-5.16	0.55	-78.00	-18.64	0.117	-64.67	0.75	27.23	4.93
17.0	0.94	28.40	-5.30	0.54	-84.20	-17.72	0.130	-71.07	0.77	20.77	4.97
18.0	0.93	24.90	-6.29	0.49	-88.30	-17.86	0.128	-75.90	0.79	15.87	3.70

Typical Noise Parameters, $V_{DS} = 4V$, $I_{DS} = 40\text{ mA}$

Freq GHz	F_{min} dB	Γ_{opt} Mag.	Γ_{opt} Ang.	$R_n/50$	G_a dB
0.50	0.4	0.335	0.5	0.07	21.8
0.90	0.43	0.332	27.9	0.06	18.83
1.00	0.44	0.332	34.3	0.06	18.59
1.50	0.48	0.338	63.8	0.05	16.22
1.80	0.51	0.345	79.6	0.05	15.46
2.00	0.52	0.352	89.3	0.05	14.61
2.50	0.57	0.373	111.3	0.05	13.34
3.00	0.61	0.4	130	0.04	12.29
4.00	0.69	0.467	158.9	0.03	10.47
5.00	0.78	0.542	178.7	0.03	8.96
6.00	0.86	0.617	-167.8	0.02	8.05
7.00	0.95	0.68	-158.1	0.04	7.19
8.00	1.03	0.724	-149.3	0.06	6.41
9.00	1.12	0.738	-138.9	0.1	6.15
10.00	1.2	0.712	-124.2	0.18	5.07

Notes:

1. The F_{min} values are based on a set of 16 noise figure measurements made at 16 different impedances using an ATN NP5 test system. From these measurements F_{min} is calculated. Refer to the noise parameter measurement section for more information.
2. S and noise parameters are measured on a microstrip line made on 0.010 inch thick alumina carrier assembly. The input reference plane is at the end of the gate pad. The output reference plane is at the end of the drain pad.

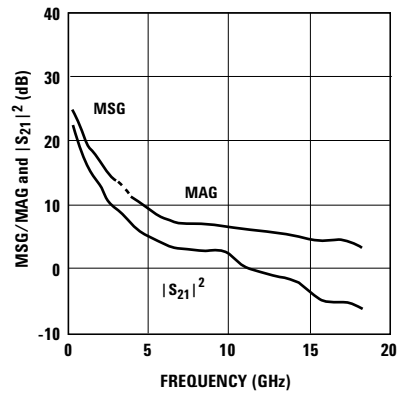

Figure 21. MSG/MAG and $|S_{21}|^2$ vs. Frequency at 4V, 40 mA.

ATF-331M4 Typical Scattering Parameters, $V_{DS} = 4V$, $I_{DS} = 60\text{ mA}$

Freq. GHz	S11			S21			S12		S22		MSG/MAG dB
	Mag.	Ang.	dB	Mag.	Ang.	dB	Mag.	Ang.	Mag.	Ang.	
0.5	0.81	-93.00	23.11	14.30	127.30	-28.64	0.037	53.90	0.37	-161.30	25.87
0.8	0.78	-120.00	19.90	9.89	112.40	-26.56	0.047	48.30	0.43	-169.07	23.23
1.0	0.77	-133.00	19.03	8.94	105.60	-25.68	0.052	46.80	0.45	-173.33	22.35
1.5	0.75	-152.00	15.74	6.12	93.43	-23.88	0.064	45.83	0.48	178.37	19.81
1.8	0.74	-160.00	14.50	5.31	87.90	-22.85	0.072	45.73	0.48	174.33	18.68
2.0	0.74	-164.00	14.24	5.15	84.80	-22.27	0.077	45.83	0.49	171.87	18.25
2.5	0.72	-171.00	11.29	3.67	77.77	-20.82	0.091	45.73	0.49	165.90	16.06
3.0	0.69	-175.00	10.21	3.24	71.63	-19.25	0.109	45.27	0.51	162.80	14.73
4.0	0.71	163.00	7.64	2.41	52.93	-17.65	0.131	35.20	0.51	138.63	11.41
5.0	0.73	150.00	5.93	1.98	41.40	-17.08	0.140	30.07	0.51	135.70	9.89
6.0	0.71	141.00	4.81	1.74	28.60	-16.48	0.150	22.23	0.52	118.43	8.31
7.0	0.73	124.00	3.75	1.54	14.30	-15.65	0.165	11.90	0.53	111.93	7.56
8.0	0.74	113.00	3.52	1.50	6.20	-15.24	0.173	7.07	0.53	111.10	7.52
9.0	0.76	97.90	3.29	1.46	-5.37	-15.14	0.175	-1.87	0.54	95.43	7.31
10.0	0.79	83.70	2.67	1.36	-18.90	-14.89	0.180	-13.17	0.54	80.60	7.10
11.0	0.86	62.10	0.83	1.10	-33.30	-14.89	0.180	-25.67	0.54	67.90	6.92
12.0	0.87	62.30	0.00	1.00	-38.80	-14.42	0.190	-29.70	0.60	61.93	6.50
13.0	0.88	52.20	-0.82	0.91	-50.80	-14.89	0.180	-40.67	0.65	51.07	5.93
14.0	0.89	44.70	-1.41	0.85	-60.10	-15.39	0.170	-48.97	0.69	41.93	5.76
15.0	0.92	39.00	-3.22	0.69	-69.20	-15.65	0.165	-57.33	0.72	32.27	5.53
16.0	0.94	33.30	-4.88	0.57	-76.60	-18.42	0.120	-64.27	0.75	26.33	5.19
17.0	0.94	28.20	-5.04	0.56	-82.80	-17.59	0.132	-70.77	0.77	19.97	5.22
18.0	0.93	24.70	-6.02	0.50	-86.90	-17.72	0.130	-75.60	0.79	15.07	3.90

Typical Noise Parameters, $V_{DS} = 4V$, $I_{DS} = 60\text{ mA}$

Freq GHz	F_{min} dB	Γ_{opt} Mag.	Γ_{opt} Ang.	$R_n/50$	G_a dB
0.50	0.38	0.316	0.7	0.06	22.33
0.90	0.42	0.314	28.9	0.06	19.23
1.00	0.43	0.314	35.5	0.06	19.1
1.50	0.47	0.321	65.7	0.05	16.63
1.80	0.5	0.329	81.9	0.05	15.86
2.00	0.52	0.336	91.9	0.05	14.96
2.50	0.56	0.358	114.3	0.04	13.73
3.00	0.61	0.386	133.2	0.04	12.58
4.00	0.7	0.454	162.3	0.03	10.78
5.00	0.79	0.53	-178.1	0.03	9.3
6.00	0.88	0.606	-165.1	0.02	8.32
7.00	0.97	0.67	-155.8	0.04	7.44
8.00	1.06	0.714	-147.4	0.07	6.59
9.00	1.16	0.728	-137.1	0.11	6.36
10.00	1.25	0.703	-121.9	0.19	5.27

Notes:

1. The F_{min} values are based on a set of 16 noise figure measurements made at 16 different impedances using an ATN NP5 test system. From these measurements F_{min} is calculated. Refer to the noise parameter measurement section for more information.
2. S and noise parameters are measured on a microstrip line made on 0.010 inch thick alumina carrier assembly. The input reference plane is at the end of the gate pad. The output reference plane is at the end of the drain pad.

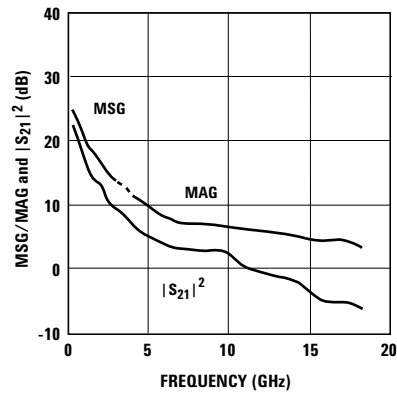

Figure 22. MSG/MAG and $|S_{21}|^2$ vs. Frequency at 4V, 60mA.

S and Noise Parameter Measurements

The position of the reference planes used for the measurement of both S and Noise Parameter measurements is shown in Figure 23. The reference plane can be described as being at the center of both the gate and drain pads.

S and noise parameters are measured with a 50 ohm microstrip test fixture made with a 0.010" thickness aluminum substrate. Both source pads are connected directly to ground via a 0.010" thickness metal rib which provides a very low inductance path to ground for both source pads. The inductance associated with the addition of printed circuit board plated through holes and source bypass capacitors must be added to the computer circuit simulation to properly model the effect of grounding the source leads in a typical amplifier design.

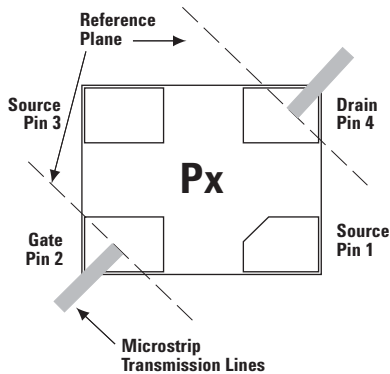

Figure 23. Position of the Reference Planes.

Noise Parameter Applications Information

The F_{min} values are based on a set of 16 noise figure measurements made at 16 different impedances using an ATN NP5 test system. From these measurements, a true F_{min} is calculated. F_{min} represents the true minimum noise figure of the device when the device is presented with an impedance matching network that transforms the source impedance, typically 50Ω , to an impedance represented by the reflection coefficient Γ_o . The designer must design

a matching network that will present Γ_o to the device with minimal associated circuit losses. The noise figure of the completed amplifier is equal to the noise figure of the device plus the losses of the matching network preceding the device. The noise figure of the device is equal to F_{min} only when the device is presented with Γ_o . If the reflection coefficient of the matching network is other than Γ_o , then the noise figure of the device will be greater than F_{min} based on the following equation.

$$NF = F_{min} + 4 \frac{R_n}{Z_o} \frac{|\Gamma_s - \Gamma_o|^2}{(|1 + \Gamma_o|^2)(1 - |\Gamma_s|^2)}$$

Where R_n/Z_o is the normalized noise resistance, Γ_o is the optimum reflection coefficient required to produce F_{min} and Γ_s is the reflection coefficient of the source impedance actually presented to the device.

The losses of the matching networks are non-zero and they will also add to the noise figure of the device creating a higher amplifier noise figure. The losses of the matching networks are related to the Q of the components and associated printed circuit board loss. Γ_o is typically fairly low at higher frequencies and increases as frequency is lowered. Larger gate width devices will typically have a lower Γ_o as compared to narrower gate width devices. Typically for FETs, the higher Γ_o usually infers that an impedance much higher than 50Ω is required for the device to produce F_{min} . At VHF frequencies and even lower L Band frequencies, the required impedance can be in the vicinity of several thousand ohms. Matching to such a high impedance requires very hi-Q components in order to minimize circuit losses. As an example at 900 MHz, when air wound coils ($Q > 100$) are used for matching networks, the loss can still be up to 0.25 dB which will add directly to the noise figure of the device. Using multilayer molded inductors with Q_s in the 30 to 50 range results in additional loss over the air wound coil. Losses as high as 0.5 dB or greater add to the typical 0.15 dB F_{min} of the device creating an amplifier noise figure of nearly 0.65 dB.

ATF-331M4 Die Model

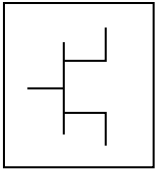

Advanced_Curtice2_Model

MESFETM1

NFET=yes	Cgs=1.764 pF	Rc=62.5	Taumd=no
PFET=no	Gdcap=3	Gsfwd=1	Fnc=1 E6
Vto=0.95	Cgd=0.338 pF	Gsrev=0	R=0.17
Beta=0.48	Rgd=	Gdfwd=1	C=0.2
Lambda=0.09	Tqm=	Gdrev=0	P=0.65
Alpha=4	Vmax=	Vjr=1	wVg fwd=
B=0.8	Fc=	Is=1 nA	wBvgs=
Tnom=27	Rd=0.125	Ir=1 nA	wBvgd=
Idstc=	Rg=1	Imax=0.1	wBvds=
Vbi=0.7	Rs=0.0625	Xti=	wldsmx=
Tau=	Ld=0.0034 nH	N=	wPmax=
Betatce=	Lg=0.0039 nH	Eg=	AllParams=
Delta1=0.2	Ls=0.0012 nH	Vbr=	
Delta2=	Cds=0.0776 pF	Vtotc=	
Gscap=3	Crf=0.1	Rin=	

This model can be used as a design tool. It has been tested on ADS for various specifications. However, for more precise and accurate design, please refer to the measured data in this data sheet. For future improvements, Avago reserves the right to change these models without prior notice.

ATF-331M4 Minipak Model

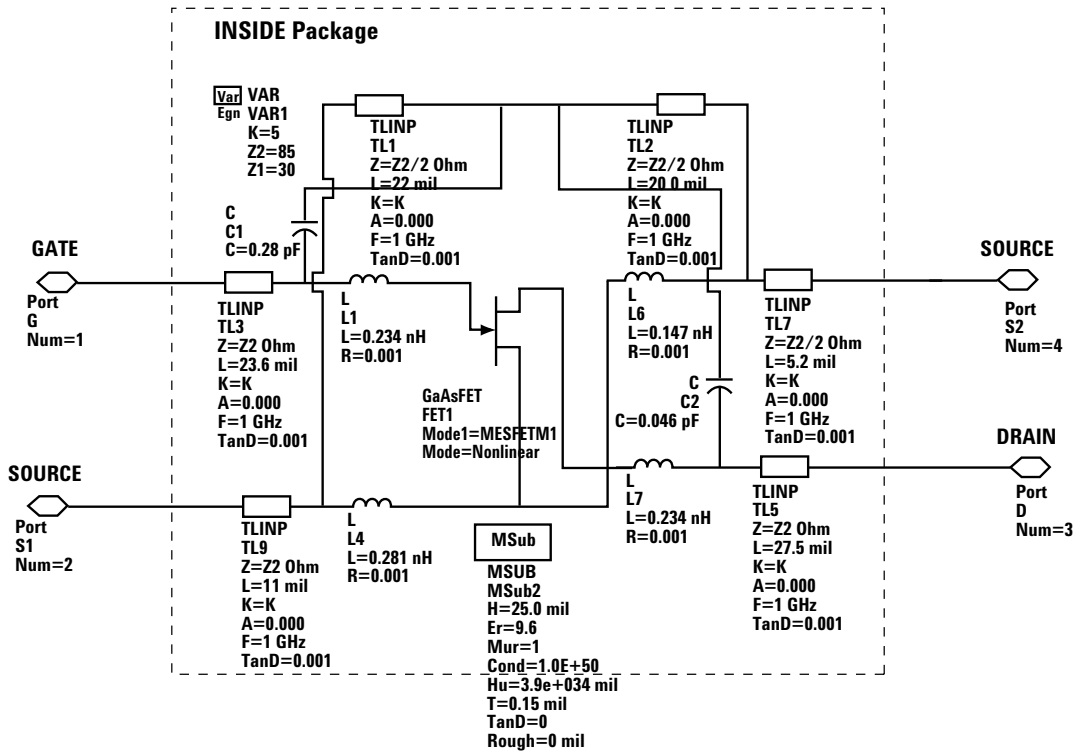

Ordering Information

Part Number	No. of Devices	Container
ATF-331M4-TR1	3000	7" Reel
ATF-331M4-TR2	10000	13" Reel
ATF-331M4-BLK	100	antistatic bag

MiniPak Package Outline Drawing

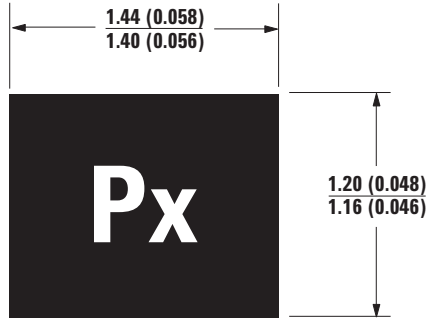

Top view



Side view

Dimensions are in millimeters (inches)

Solder Pad Dimensions

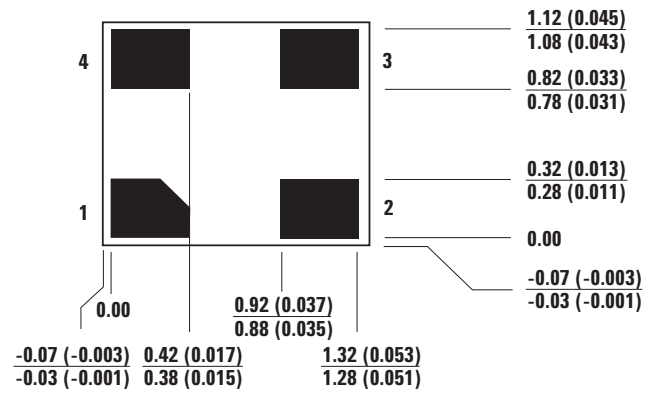

Bottom view

Device Orientation for Outline 4T, MiniPak 1412

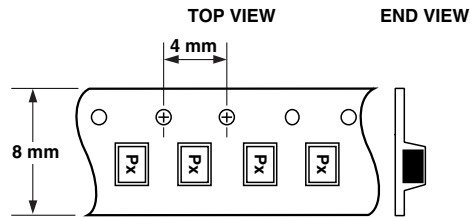
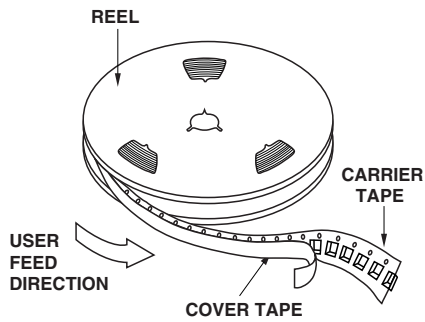

Note: Px represents Package Marking Code.
Device orientation is indicated by package marking.

Tape Dimensions

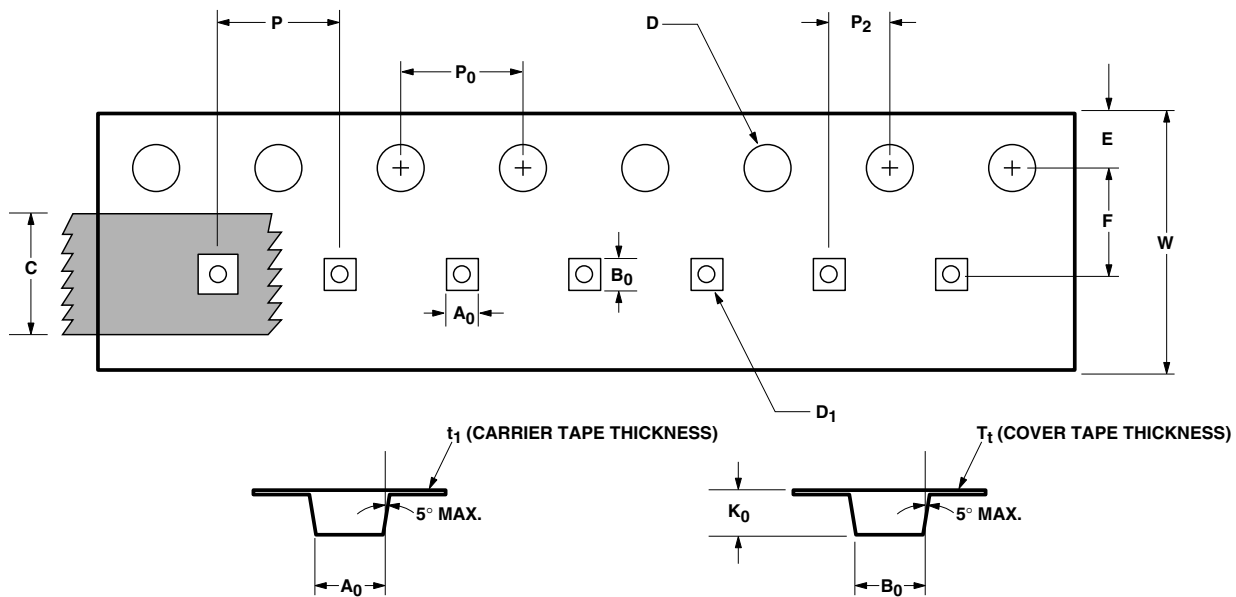

	DESCRIPTION	SYMBOL	SIZE (mm)	SIZE (INCHES)
CAVITY	LENGTH	A ₀	1.40 ± 0.05	0.055 ± 0.002
	WIDTH	B ₀	1.63 ± 0.05	0.064 ± 0.002
	DEPTH	K ₀	0.80 ± 0.05	0.031 ± 0.002
	PITCH	P	4.00 ± 0.10	0.157 ± 0.004
	BOTTOM HOLE DIAMETER	D ₁	0.80 ± 0.05	0.031 ± 0.002
PERFORATION	DIAMETER	D	1.50 ± 0.10	0.060 ± 0.004
	PITCH	P ₀	4.00 ± 0.10	0.157 ± 0.004
	POSITION	E	1.75 ± 0.10	0.069 ± 0.004
CARRIER TAPE	WIDTH	W	8.00 + 0.30 - 0.10	0.315 + 0.012 - 0.004
	THICKNESS	t ₁	0.254 ± 0.02	0.010 ± 0.0008
COVER TAPE	WIDTH	C	5.40 ± 0.10	0.213 ± 0.004
	TAPE THICKNESS	T _t	0.062 ± 0.001	0.0024 ± 0.00004
DISTANCE	CAVITY TO PERFORATION (WIDTH DIRECTION)	F	3.50 ± 0.05	0.138 ± 0.002
	CAVITY TO PERFORATION (LENGTH DIRECTION)	P ₂	2.00 ± 0.05	0.079 ± 0.002

For product information and a complete list of distributors, please go to our web site: www.avagotech.com

Avago, Avago Technologies, and the A logo are trademarks of Avago Technologies in the United States and other countries. Data subject to change. Copyright © 2005-2012 Avago Technologies. All rights reserved. Obsoletes 5989-4216EN AV02-3621EN - June 14, 2012

AVAGO
TECHNOLOGIES