

AZ DISPLAYS, INC.

COMPLETE LCD SOLUTIONS

ATM3224C-NC-FTH

PRODUCT SPECIFICATIONS

- APPLICATION
- FEATURES
- MECHANICAL SPECIFICATIONS
- BLOCK DIAGRAM
- INPUT / OUTPUT TERMINALS
- ABSOLUTE MAXIMUM RATINGS
- ELECTRICAL CHARACTERISTICS
- POWER ON SEQUENCE
- OPTICAL CHARACTERISTICS
- MECHANICAL DRAWING

Date: October 2, 2003

ATM3224C-NC-FTH

5 " TFT

■ APPLICATION

This technical specification applies to a 5 " color TFT LCD module. Popular applications for the panel are car TV, portable DVD and GPS.

■ FEATURES

- Compatible with NTSC & PAL system
- Pixel in stripe configuration
- Slim and compact
- Vcom Toggle
- Image Reversion : UP/Down and Left/Right

■ MECHANICAL SPECIFICATIONS

Parameter	Specifications	Unit
Screen size	5" (diagonal)	Inch
Display format	320 x RGB x 234	Dot
Active area	102.720 (H) x 74.529 (V)	mm
Dot pitch	0.1070 (H) x 0.3185 (V)	mm
Pixel configuration	Stripe	---
Outline dimension	127.4 (W) x 92.8 (H) x 12.9 (D)	mm
Weight	160±10	g

■ BLOCK DIAGRAM

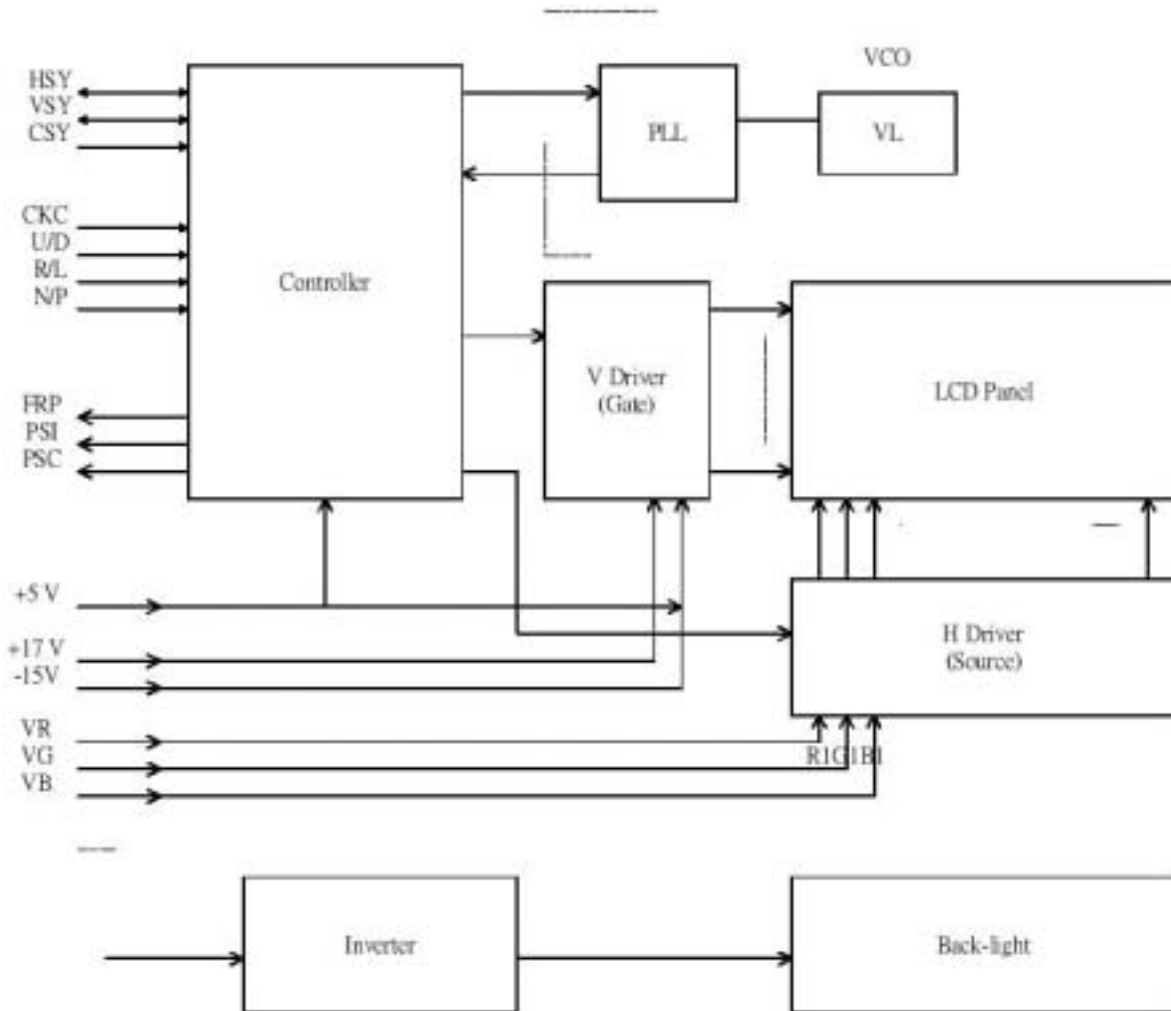

■ INPUT / OUTPUT TERMINALS

TFT LCD Panel Driving

Pin No	Symbol	I/O	Description	Remark
1	/HSY	I/O	Horizontal sync input / output	
2	FRP	O	Video polarity alternating signal	
3	CSY / HSY	I	Composite sync signal	Note 1
4	V _{GH}	I	Supply voltage for gate driver (Hi level)	Note 2
5	V _{GL}	I	Supply voltage for gate driver (Low level)	Note 3
6	V _B	I	Video signal (Blue)	
7	V _R	I	Video signal (Red)	
8	V _G	I	Video signal (Green)	
9	GND	I	Ground	
10	VDD	I	Supply voltage for controller	Note 4
11	VCC	I	Supply voltage for source driver	Note 5
12	GND	I	Ground	
13	CKC	I	Control pin for select I/O signal	Note 1
14	/VSY	I/O	Vertical sync input/output	
15	PSI	O	Synchronize pulse for decoder	
16	PSC	O	Synchronize pulse for DC-DC converter	
17	NC	I	No connection / Vertical sync signal	Note 1
18	UD	I	Up / Down control	Note 7
19	RL	I	Right / Left shift control	Note 6
20	NP	I/O	NTSC / PAL selection signal (Low : PAL, High : NTSC)	Note 8

Note 1: This module can support 2 input mode. Pin #13 of CKC is for the 2 input mode selection.

Parameter	Select pin (CKC)	Description	
	CKC (pin #13)	CSY / HSY (pin #3)	NC / VSY (pin #17)
Composite sync mode	High	CSY (positive edge)	-
Sync separate mode	Low	HSY (negative edge)	VSY (positive edge)

The default mode of this module is composite sync mode (CKC = high)

If you use sync separate mode (CKC = low), please contact AZ Displays to modify some components of PCBA.

Note 2: V_{GH} (typ) = +17V

Note 3: V_{GL} (typ) = -15V

Note 4: VDD (typ) = +5V

Note 5: VCC (typ) = +5V

Note 6: Low (0V) for shift Right; input Hi (+5.0V) for inverse (shift Left).

Note 7: Hi (+5.0V) for Down; Low (0V) for Up.

Note 8: PAL = Low (0V), NTSC = Hi (+5.0V)

(If use auto detect, this pin is output, otherwise this pin is input)

	Low	High
Note 6	Right	Left
Note 7	Down	Up
Note 8	PAL	NTSC

Backlight driving

Pin No	Symbol	Description	Remark
1	VL1	Input terminal (Hi voltage side)	Wire color : pink
3	VL2	Input terminal (Low voltage side)	Wire color : white (Note 9)

Note 9: Low voltage side of backlight inverter connects with Ground of inverter circuits.

Input / Output connector

LCD module: Molex 52271-2090

FFC down connector; 20 pins, pitch: 1.0mm

Backlight connector: JST BHR-03VS-1

3 pins, pitch: 4.0mm, Pink: high voltage, White: low voltage

■ ABSOLUTE MAXIMUM RATINGS

GND=0V; Ta=25C

Parameter	Symbol	MIN.	MAX.	Unit	Remark
Supply Voltage for Source Driver	V _{CC}	-0.5	7	V	
	V _{CC}	-0.5	7	V	
Supply Voltage for Source Driver	V _{GH} , V _{GL}	-0.3	40	V	
	H Level	V _{GH}	0	40	V
	L Level	V _{GL}	-20	0	V
Analog Signal Input Level	V _R , V _G , V _B	-0.3	7.0	V	
Digital Input Signals		-0.3	5.5	V	Note1
Digital Output Signals		-0.3	5.5	V	Note2
Storage Temperature		-30	+80	C	
Operating Temperature		-20	+70	C	

Note1: /HSY, CSY, /VSY, CKC

Note2: /HSY, /VSY, PSI, PSC

■ ELECTRICAL CHARACTERISTICS

Recommended Operating Conditions

A) Driving for TFT LCD Display

GND=0V; Ta=25C

Parameter	Symbol	MIN.	TYP.	MAX.	Unit	
Supply Voltage for Source Driver	Analog	V _{CC}	4.5	5.0	5.5	V
	Logic	V _{DD}	4.5	5.0	5.5	
Supply Voltage for Gate Driver	H Level	V _{GH}	+15	+17	+19	V
	L Level	V _{GL}	-16	-15	-14	V
Supply Voltage for Controller		V _{DD}	4.5	5.0	5.5	V
Analog Signal Input Level	Amplitude		0.3	-	V _{CC} -0.3	V
Digital Input Voltage	H Level	V _{IH}	0.7 V _{DD}	-	V _{DD}	V
	L Level	V _{IL}	0.3	-	0.3 V _{DD}	V
Digital Output Voltage	H Level	V _{OH}	0.7 V _{DD}	-	V _{DD}	V
	L Level	V _{OL}	-0.3	-	0.3 V _{DD}	V

B) Driving for Backlight

Ta=25C

Parameter	Symbol	MIN.	TYP.	MAX.	Unit	Remark
Lamp Voltage	V _L	387	430	473	V _{rms}	I _L =5mA
Lamp Current	I _L	4.5	5.0	5.5	mA	
Lamp Frequency	P _L	40	43	80	KHz	Note 1
Starting Voltage (25C)	V _S	-	-	345	V _{rms}	Note 2
Starting Voltage (0C)	V _S	-	-	520	V _{rms}	Note 2

Note 1: The waveform of Lamp Driving Voltage should be as close to SIN wave as possible.

Note 2: Starting Voltage Time: 1 sec.

Power Consumption

Ta=25C

Parameter	Symbol	Conditions	TYP.	MAX.	Unit	Remark
Supply Current for Gate Driver (Hi Level)	I _{GH}	V _{GH} = +17V	0.15	0.20	mA	
Supply Current for Gate Driver (Lo Level)	I _{GL}	V _{GL} = -15V	-10.0	-15.0	mA	
Supply Current for Source Driver	I _{CC}	V _{CC} = +5V	17.0	20.0	mA	
Supply Current for Controller	I _{DD}	V _{DD} = +5V	43.0	48.0	mA	
LCD Display Power Consumption			0.45	0.57	W	Note 3
Backlight Power Consumption			2.65	2.80	W	Note 4

Note 3: Power Consumption for Backlight is excluded.

Note 4: Backlight Power Consumption is calculated by I_L x V_L.

Input / Output signal timing chart

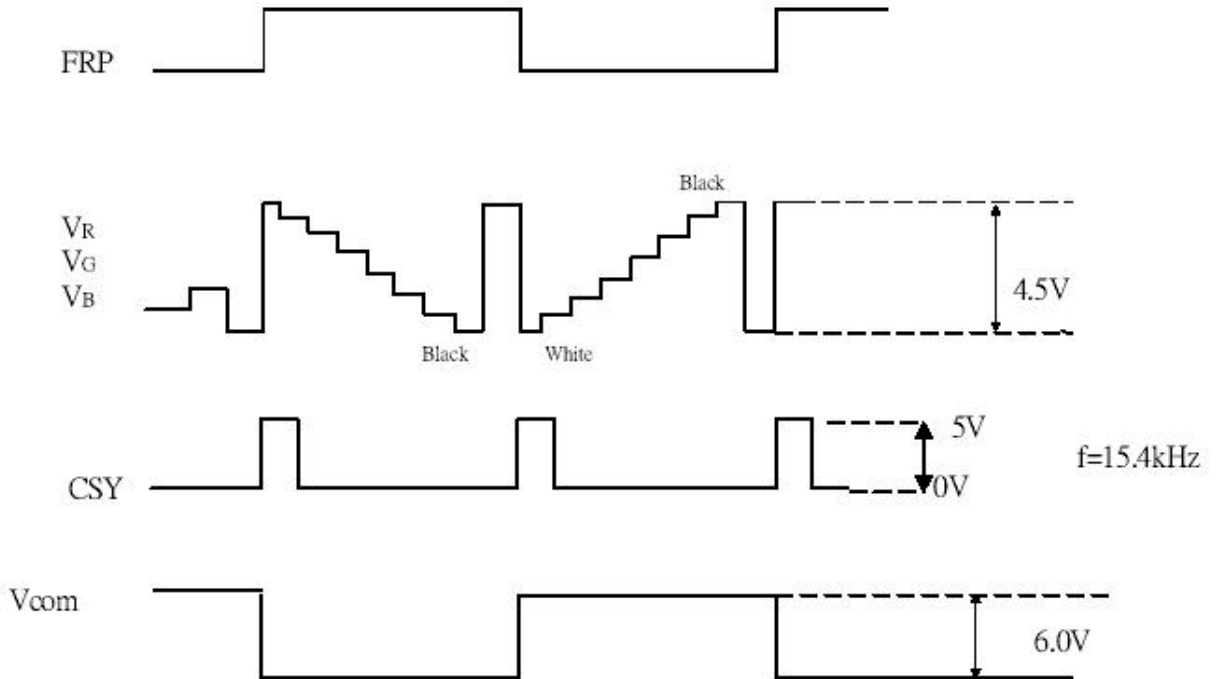

Parameter		Symbol	MIN.	TYP.	MAX.	Unit	Remarks	
Horizontal sync output pulse	Frequency	NTSC	$F_{HO} (N)$	-	15.73	-	KHz	
		PAL	$F_{HO} (P)$	-	15.63	-	KHz	
	Pulse width		T_{HO}	4.4	4.7	5.0	∞	
	Phase difference		T_{HP}	0	2	-	∞	
	Rising time		T_{HR}	-	-	0.05	∞	
	Falling time		T_{HF}	-	-	0.05	∞	
Vertical sync output pulse	Frequency	NTSC		$fh/262.5$				
		PAL		$fh/312.5$				
	Pulse width		T_{VO}	-	4H	-	H	
	Phase difference	NTSC	$T_{VPO} (N)$	-	4H	-	H	Odd field
		PAL	$T_{VPO} (P)$	-	4H	-	H	
	Phase difference	NTSC	$T_{VPE} (N)$	-	4.5H	-	H	Even field
PAL		$T_{VPE} (P)$	-	3.5H	-	H		

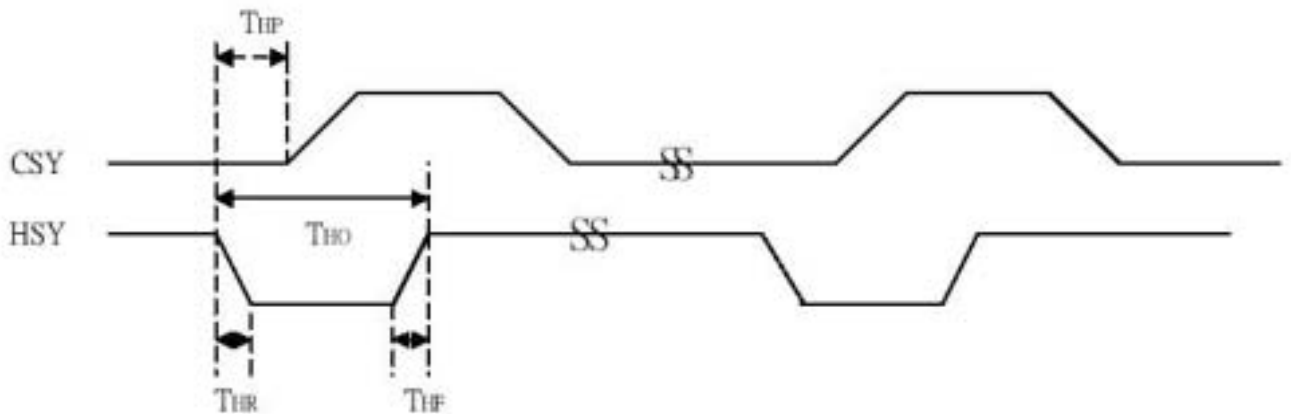

Time Range

A) When sync signal of NTSC system is applied.

Horizontal : 11.35 ~ 61.36 μ s

Vertical : 22 ~ 252H

B) When sync signal of PAL system is applied.

Horizontal : 11.54 ~ 61.9 μ s

Vertical : 29 ~ 301H

ATM3224C-NC-FTH

5" TFT

C) NTSC system

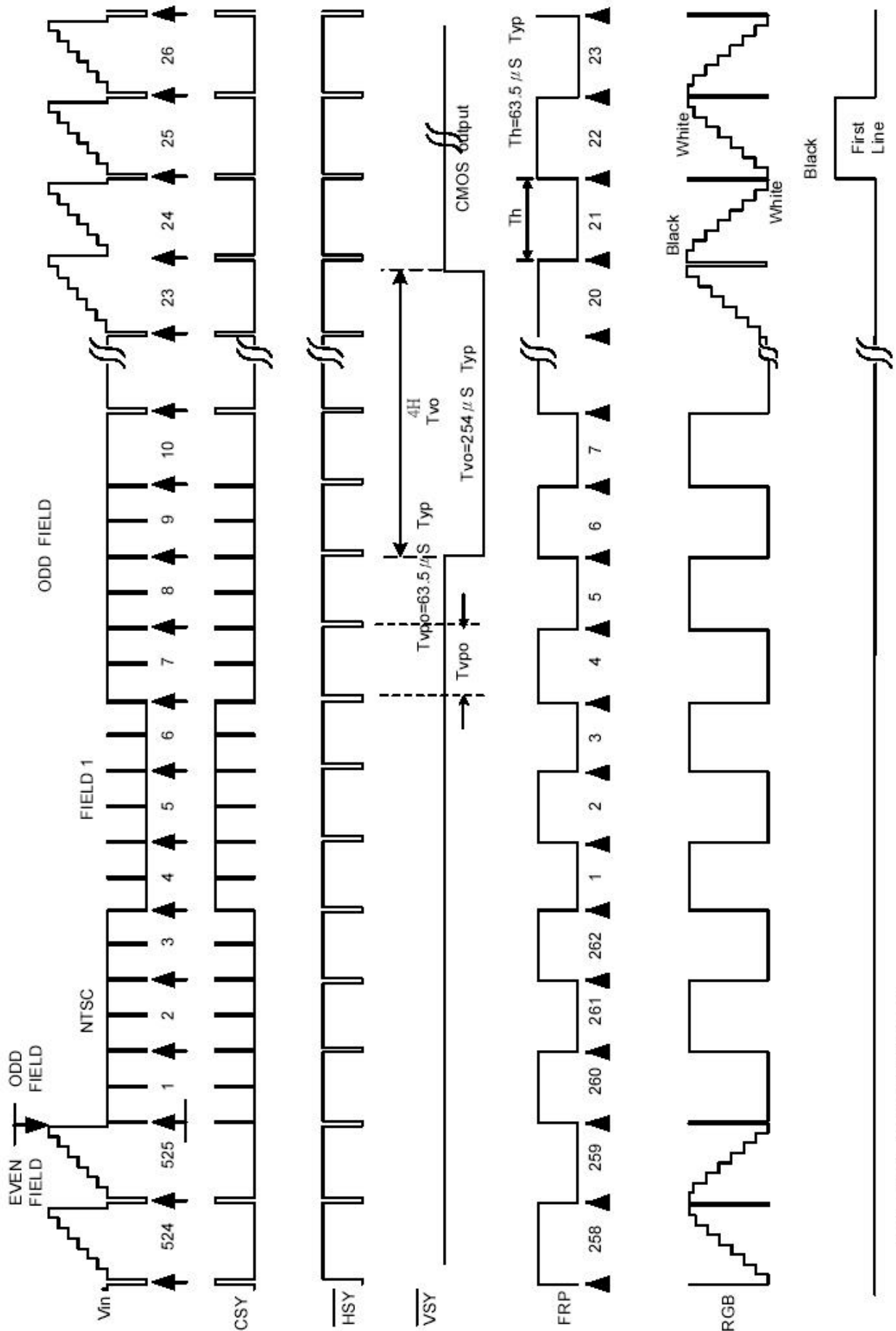

Timing chart of I/O and RGB signal

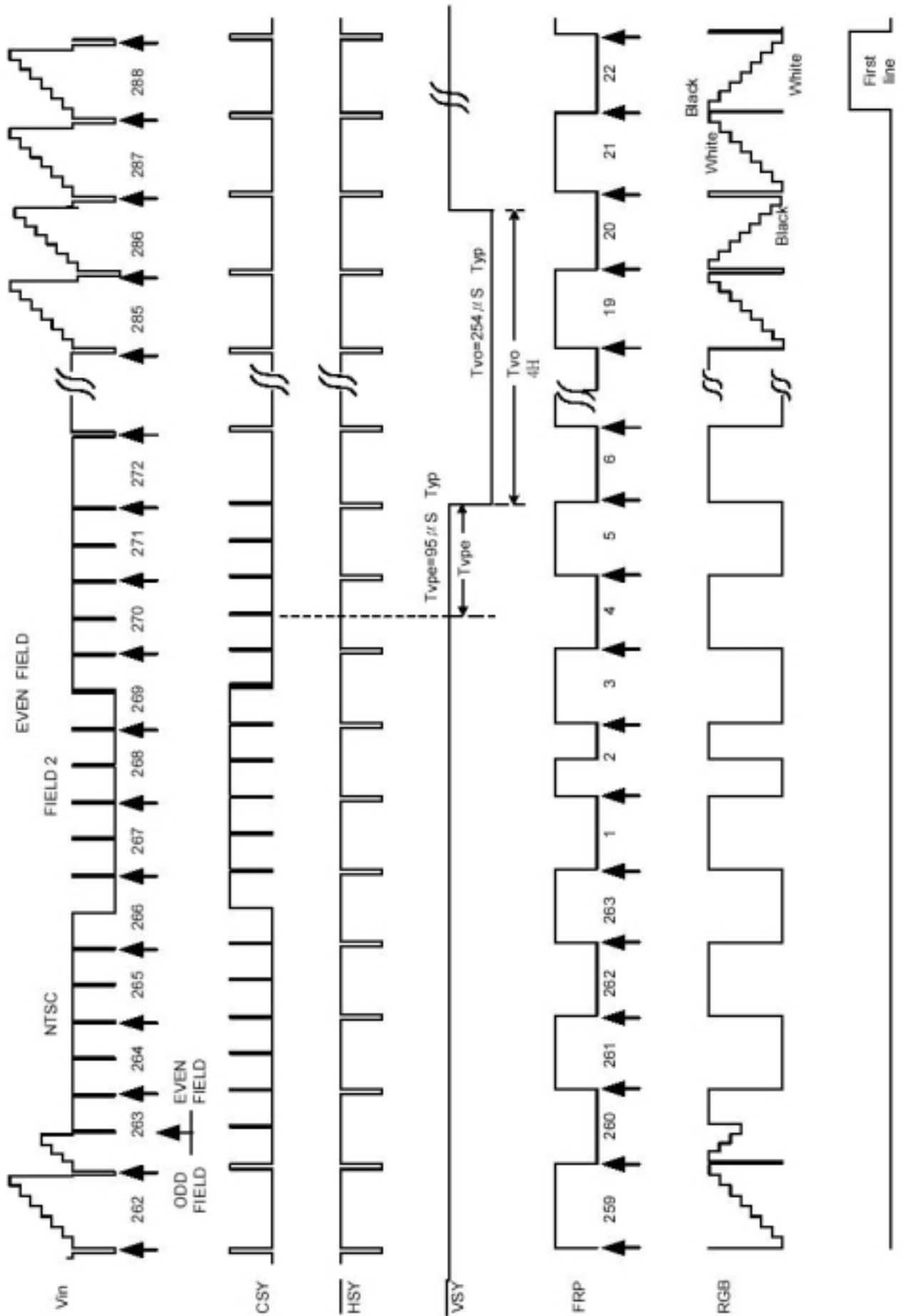

Timing chart of I/O and RGB signal

D) PAL system

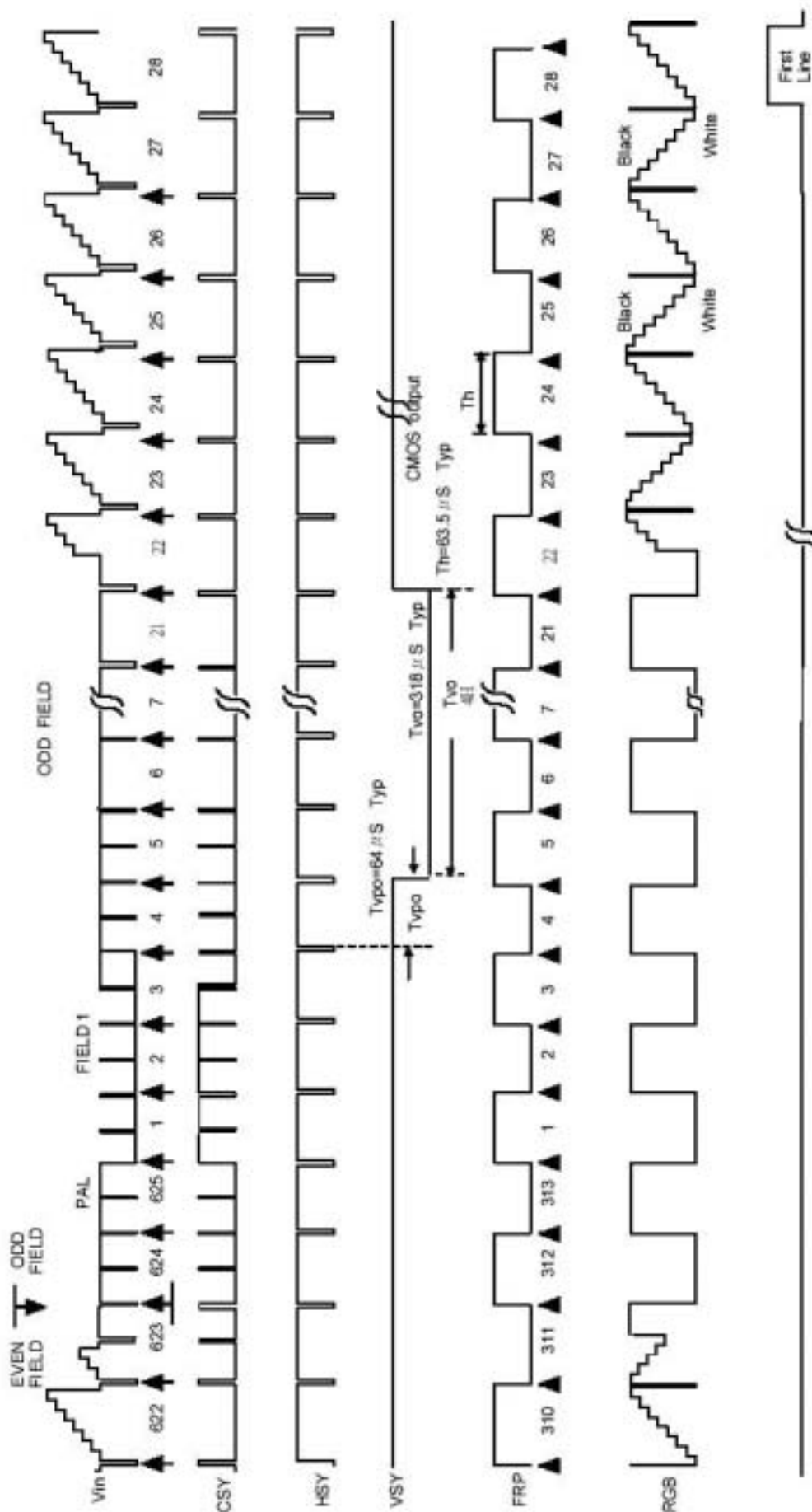

Timing chart of I/O and RGB signal

ATM3224C-NC-FTH

5" TFT

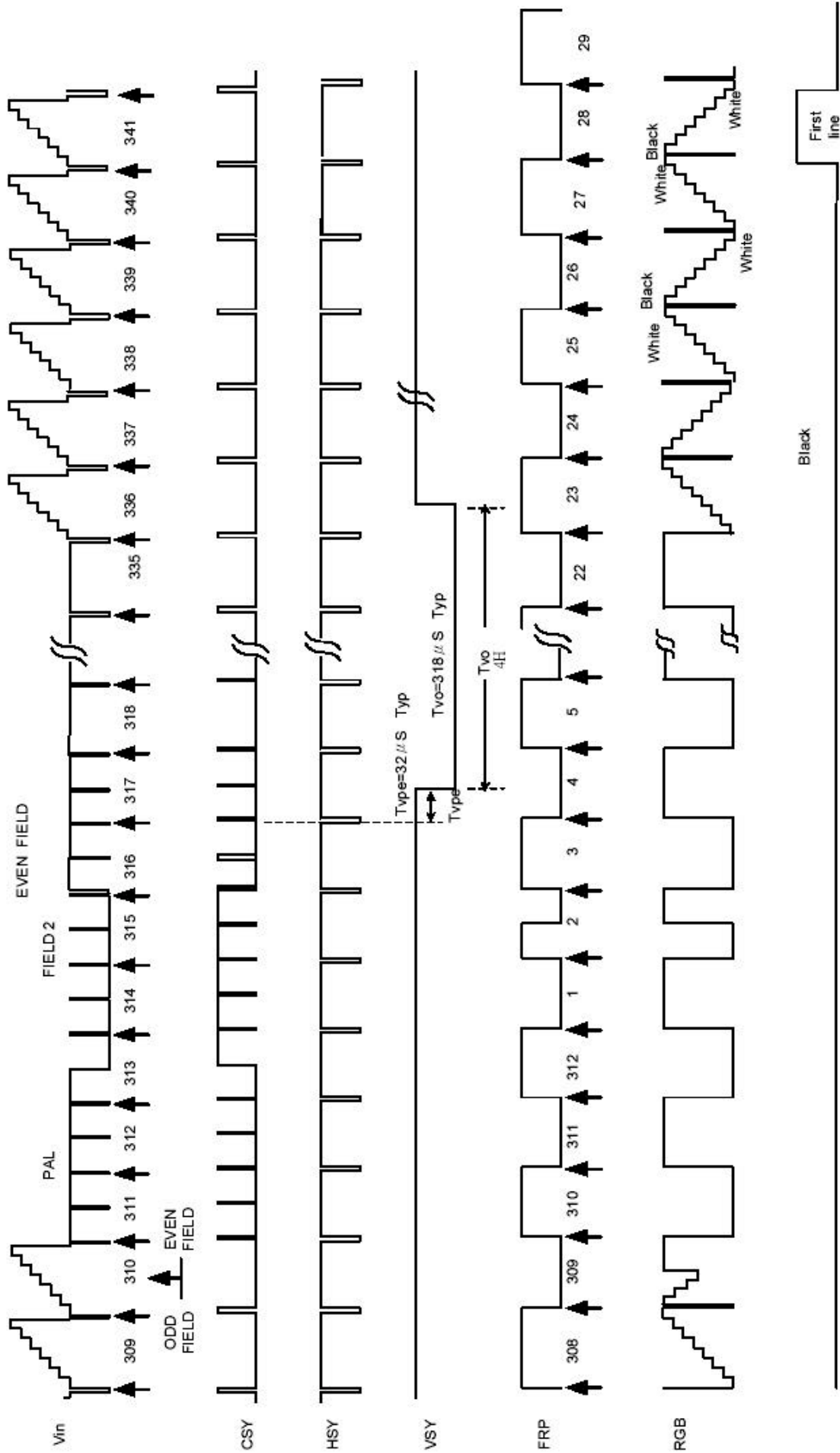

Timing chart of I/O and RGB signal

ATM3224C-NC-FTH

5" TFT

E) Display timing for NTSC & PAL

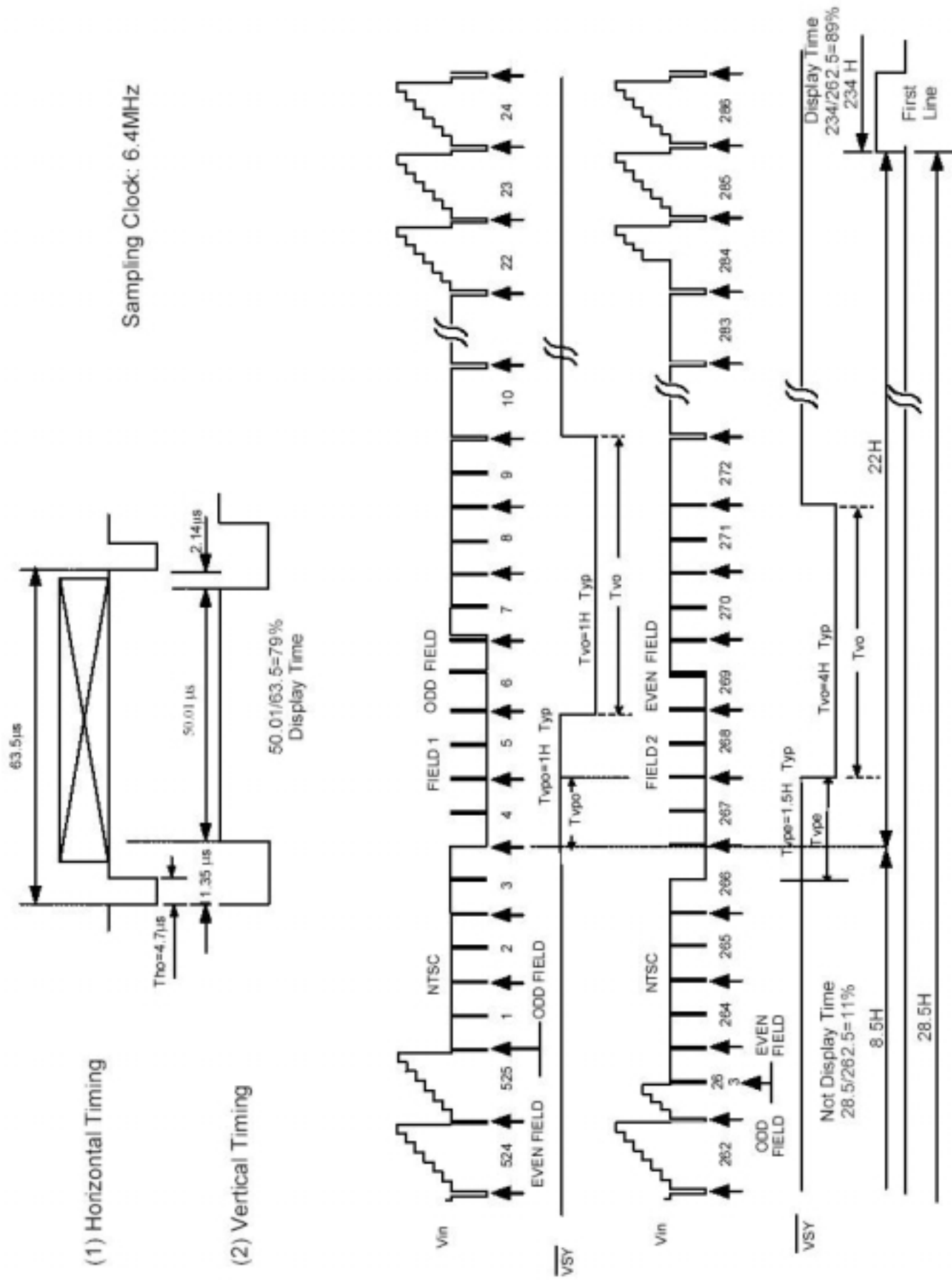

ATM3224C-NC-FTH

5" TFT

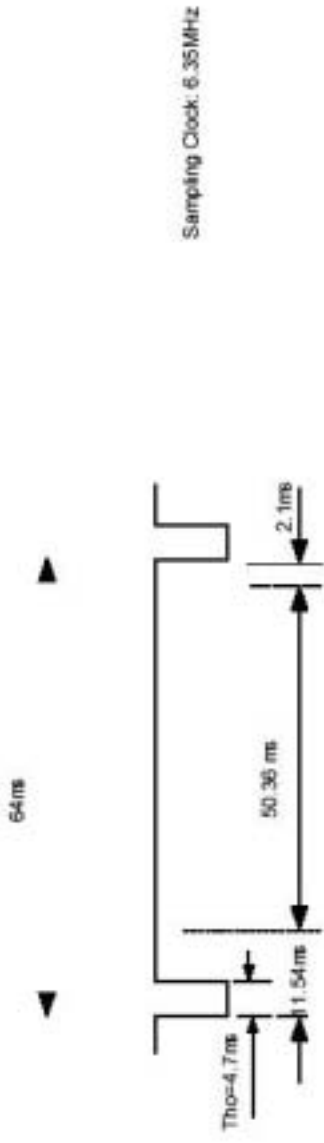

(1) Horizontal Timing

(2) Vertical Timing

50.36/64=79%
Display Time

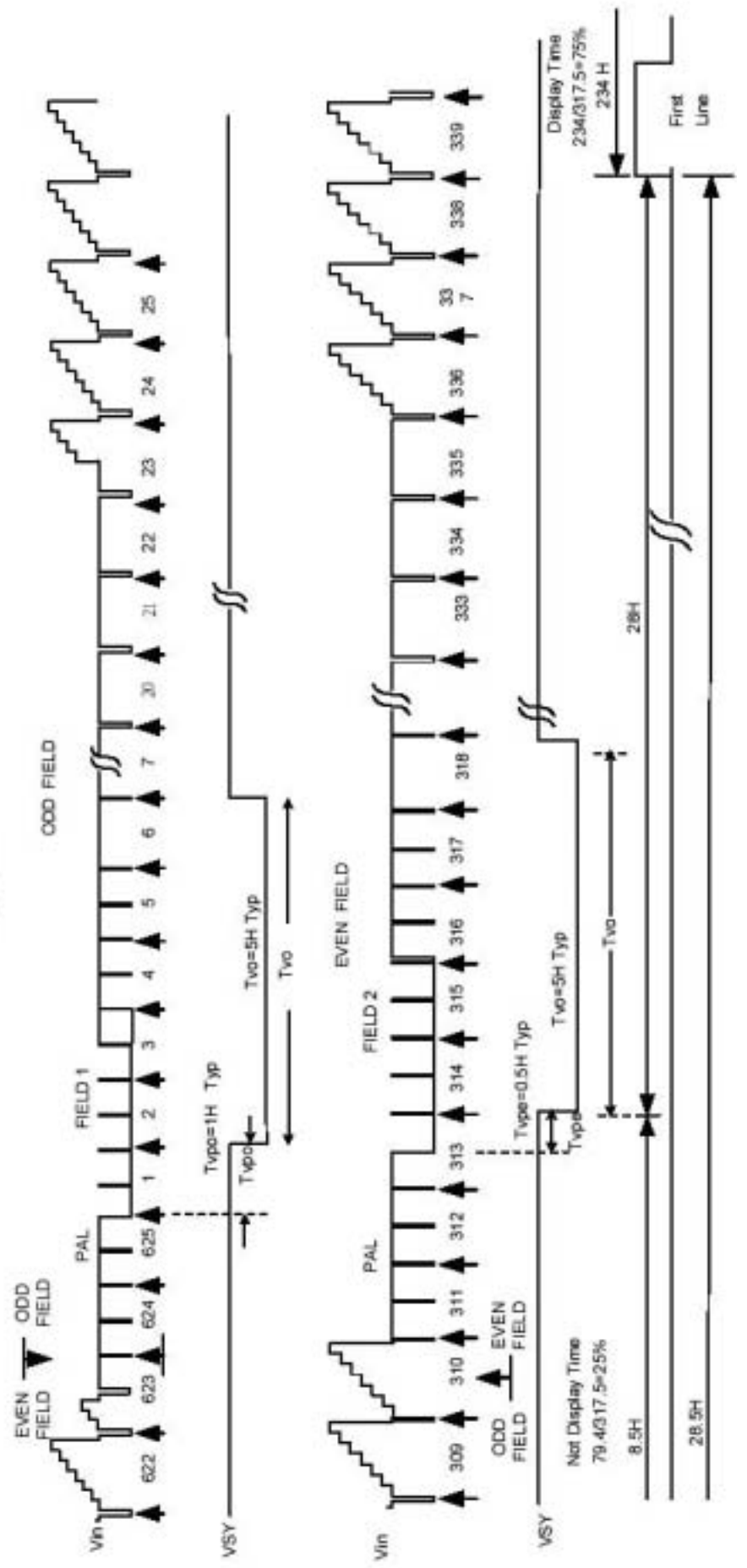

ATM3224C-NC-FTH

5" TFT

■ POWER ON SEQUENCE

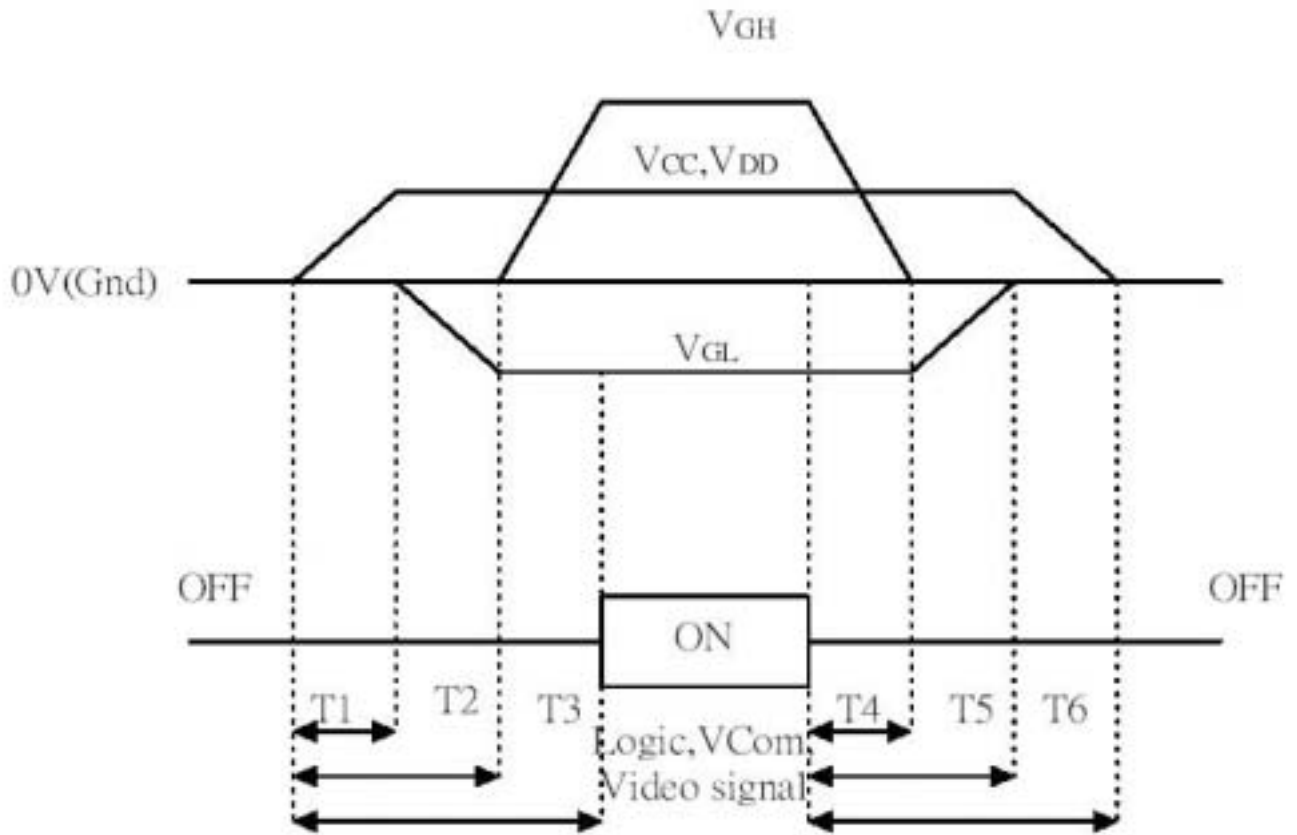

- 1) $10\text{ms} \leq T1 \leq T2 \leq T3$
- 2) $10\text{ms} \leq T4 \leq T5 \leq T6$

■ OPTICAL CHARACTERISTICS

Specification

Ta = 25°C

Parameter	Symbol	Condition	MIN.	TYP.	MAX.	Unit	Remarks
Viewing angle	Horizontal	21, 22	45	55	-	deg	Note 1
	Vertical	11	30	35	-	deg	Note 1
		12	10	15	-	deg	Note 1
Contrast ratio	CR	= 0°	80	150	-		Note 2
Response time	Rise	Tr	-	15	30	ms	Note 4
	Fall	Tf	-	30	50	ms	
Transmission ratio			8.0	8.5	-	%	
Uniformity	U		70	85	-	%	Note 5
Brightness			350	400	-	cd/m ²	Note 3
White chromaticity	x	= 0°	0.250	0.300	0.350		Note 3
	y	= 0°	0.300	0.350	0.400		
Lamp life time (+25°C)			10,000	-	-	hr	

ATM3224C-NC-FTH

5" TFT

Note 1: The definitions of viewing angles

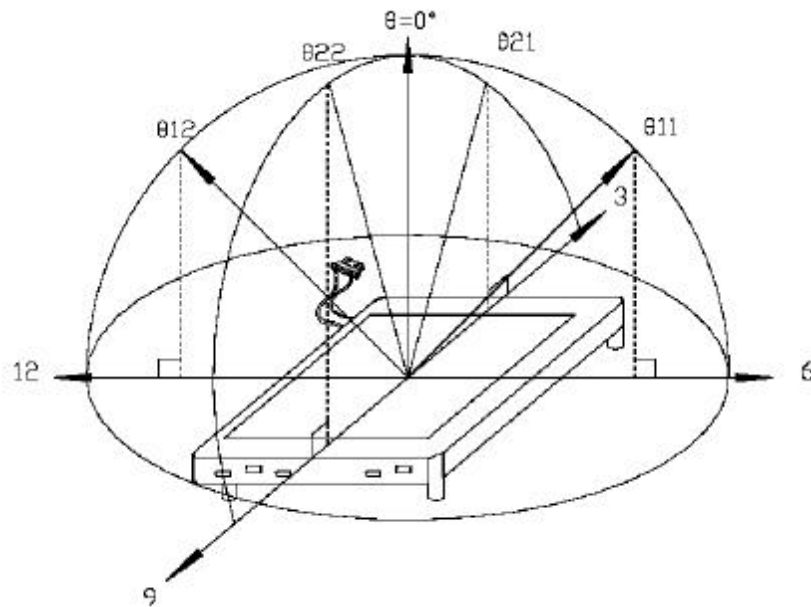

Note 2: $CR = \frac{\text{Luminance when testing point is White}}{\text{Luminance when testing point is Black}}$
 (Testing configuration is shown below)

Contrast ratio is measured in optimum common electrode voltage.

Note 3: Topcon BM-7 (fast) luminance meter 2° field of view is used in the testing (after 20 ~ 30 minutes operation).
 Lamp current 5mA

Note 4: The definition of response time:

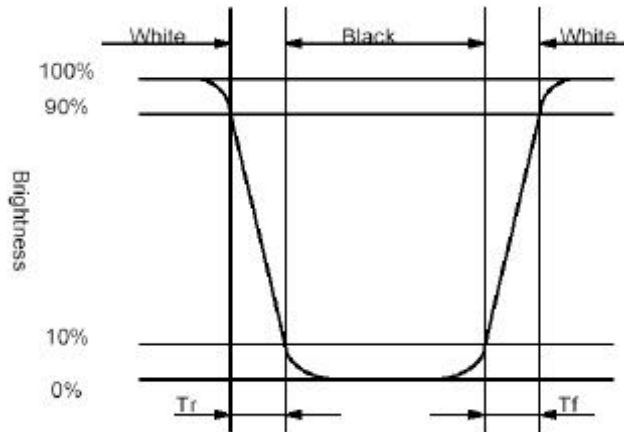

Note 5: The uniformity of LCD is defined as $U = \frac{\text{The minimum brightness of the 9 testing points}}{\text{The maximum brightness of the 9 testing points}}$

Luminance meter: BM-5A or BM-7 fast (Topcon)
 Measurement distance: 500mm +/-50mm
 Ambient illumination: < 1 Lux
 Measuring direction: Perpendicular to the surface of module
 The test pattern is white (Gray level 63)

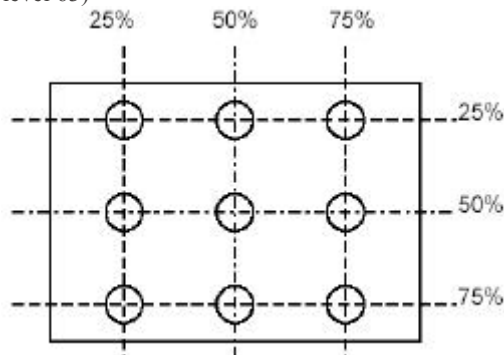

ATM3224C-NC-FTH

5" TFT

MECHANICAL DRAWING

REV.	ENR. NO.	DESCRIPTION	DESIGN	CHECK	APPROVE	DATE
		INITIAL RELEASE				2006.7.9

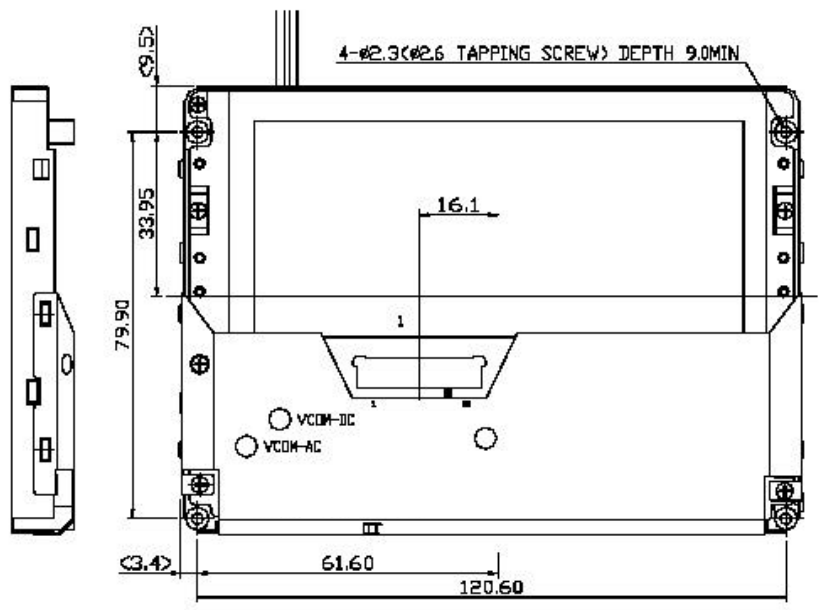
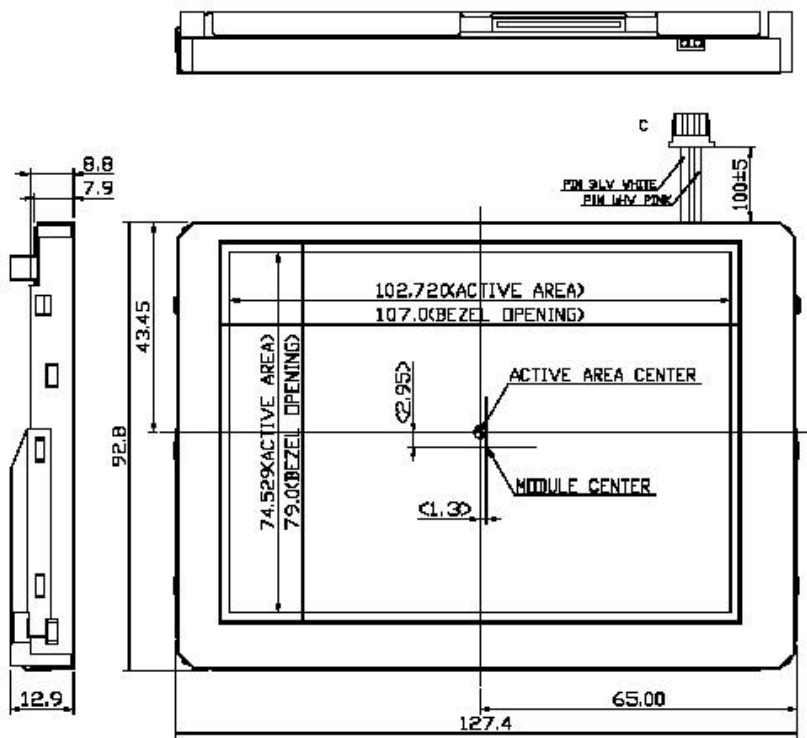

NOTE
 1.CN 1(MOLEX,52271-2090)
 2.CN 2(IJST BHR-03VS-1)
 3.GENERAL TOLERANCE±0.5mm

MATERIAL		HEAT & SURFACE TREATMENT		AZ DISPLAYS, INC.	
APPROVE		INSPECTION METHOD	DWG. NAME		
CHECK		UNL. NAME	DWG. NO.	REV.	
DESIGN					