

Data Book

AU6331

USB2.0 SD/MMC/MS

Single/Dual LUN

Card Reader Controller

Technical Reference Manual

Product Specification

Official Release

Revision 1.02W

Public

Aug 2006



Data book status

Objective specification	This data book contains target specifications for product development.
Preliminary specification	This data book contains preliminary data; supplementary data may be published later.
Product specification	This data book contains final product specifications.

Revision History

Date	Revision	Description
Jul 2005	1.00W	Official release
Sep 2005	1.01W	1. Modified "5.2 Recommended Operating Conditions" 2. Moved "3.0 Power Switch Feature" to "5.6 Power Switch Feature"
Aug 2006	1.02W	Add new address of China ShenZhen Office



Copyright Notice

Copyright 1997 - 2006
Alcor Micro Corp.
All Rights Reserved.

Trademark Acknowledgements

The company and product names mentioned in this document may be the trademarks or registered trademarks of their manufacturers.

Disclaimer

Alcor Micro Corp. reserves the right to change this product without prior notice. Alcor Micro Corp. makes no warranty for the use of its products and bears no responsibility for any error that appear in this document. Specifications are subject to change without prior notice.

Contact Information:

Web site: <http://www.alcormicro.com/>

Taiwan

Alcor Micro Corp.
4F, No 200 Kang Chien Rd., Nei Hu,
Taipei, Taiwan, R.O.C.
Phone: 886-2-8751-1984
Fax: 886-2-2659-7723

China ShenZhen Office

Rm.2407-08 ,Industrial Bank Building
No.4013, Shennan Road ,ShenZhen,China.
518026
Phone: (0755) 8366-9039
Fax: (0755) 8366-9101

Santa Clara Office

2901 Tasman Drive, Suite 206
Santa Clara, CA 95054
USA
Phone: (408) 845-9300
Fax: (408) 845-9086

Los Angeles Office

9070 Rancho Park Court
Rancho Cucamonga, CA 91730
USA
Phone: (909) 483-9900
Fax: (909) 944-0464



Table of Contents

1	<u>Introduction</u>	6
	<u>1.1 Description</u>	6
	<u>1.2 Features</u>	6
2	<u>Application Block Diagram</u>	7
3	<u>Pin Assignment</u>	8
	<u>3.1 Pin Assignment Diagram</u>	8
4	<u>System Architecture and Reference Design</u>	13
	<u>4.1 AU6331 Block Diagram</u>	13
5	<u>Electrical Characteristics</u>	14
	<u>5.1 Absolute Maximum Ratings</u>	14
	<u>5.2 Recommended Operating Conditions</u>	14
	<u>5.3 General DC Characteristics</u>	14
	<u>5.4 DC Electrical Characteristics for 5 volts operation</u>	15
	<u>5.5 USB Transceiver Characteristics</u>	16
	<u>5.6 Power Switch Feature</u>	19
6	<u>Mechanical Information</u>	20
7	<u>Abbreviations</u>	22



List of Figures

2.1	Block Diagram	7
3.1	48 Pin Assignment Diagram	8
3.2	28 Pin Assignment Diagram	9
4.1	AU6331 Block diagram	13
5.1	Card Detect Power-on Timing	19
6.1	48 Pin Mechanical Information Diagram	20
6.2	28 Pin Mechanical Information Diagram	21

List of Tables

3.1	48 Pin Descriptions	10
3.2	28 Pin Descriptions	12
5.1	Absolute Maximum Ratings	14
5.2	Recommended Operating Conditions	14
5.3	General DC Characteristics	14
5.4	DC Electrical Characteristics of 3.3V I/O Cells	15
5.5	Recommended Operation Conditions	16
5.6	Static characteristic : Digital in	16
5.7	Static characteristic : Analog I/O pins (DP/DM)	17
5.8	Dynamic characteristic : Analog I/O pins (DP/DM)	18



1.0 Introduction

1.1 Description

AU6331 is an USB2.0 transmission controller, which is designed as an interface bridge between USB host and SD/MS compatible flash card, such as SD, HS-SD, MMC, HS-MMC, RS-MMC, MMCmicro, MS, MS Pro and MS Duo...etc. AU6331 can read digital contents stored on memory card designed to cover a wide area of applications such as digital cameras, PDAs, MP3 players and smart phones...etc. With the AU6331, users can transfer digital data between flash memory card and PC or other electronic devices.

AU6331 inherits the distinguishing characteristic from Alcor's products, be integrated MOS switch for power supply to flash card, dynamic icon utility support, extreme low BOM cost, etc.

1.2 Features

- Support USB V2.0 specification and USB Device Class Definition for Mass Storage, Bulk-Transport V1.0
- Support SD/MMC/MS compatible flash card
- Work with default driver from Windows ME/2000/XP and Mac OS X; Windows 98/2000(SP1/SP2) and Mac OS 9 are supported by vendor driver from Alcor.
- Ping-pong FIFO implementation for concurrent bus operation
- Support multiple sectors transfer optimize performance
- Support slot-to-slot read/write operation (Dual LUN)
- Support Dynamic Icon Utility
- Support LED for bus operating indication
- Power switch integrated to reduce production BOM cost
- 48pin-LQFP for SD/MS card reader
- 28pin-SSOP for SD card reader
- Built in 3.3V to 2.5V regulator



2.0 Application Block Diagram

Following is the application diagram of a typical card reader product with AU6331. By connecting the card reader to a desktop or notebook PC through USB bus, AU6331 is implemented as a bus-powered, high speed USB card reader, which can be used as a bridge for data transfer between Desktop PC and Notebook PC.

2.1 Block Diagram

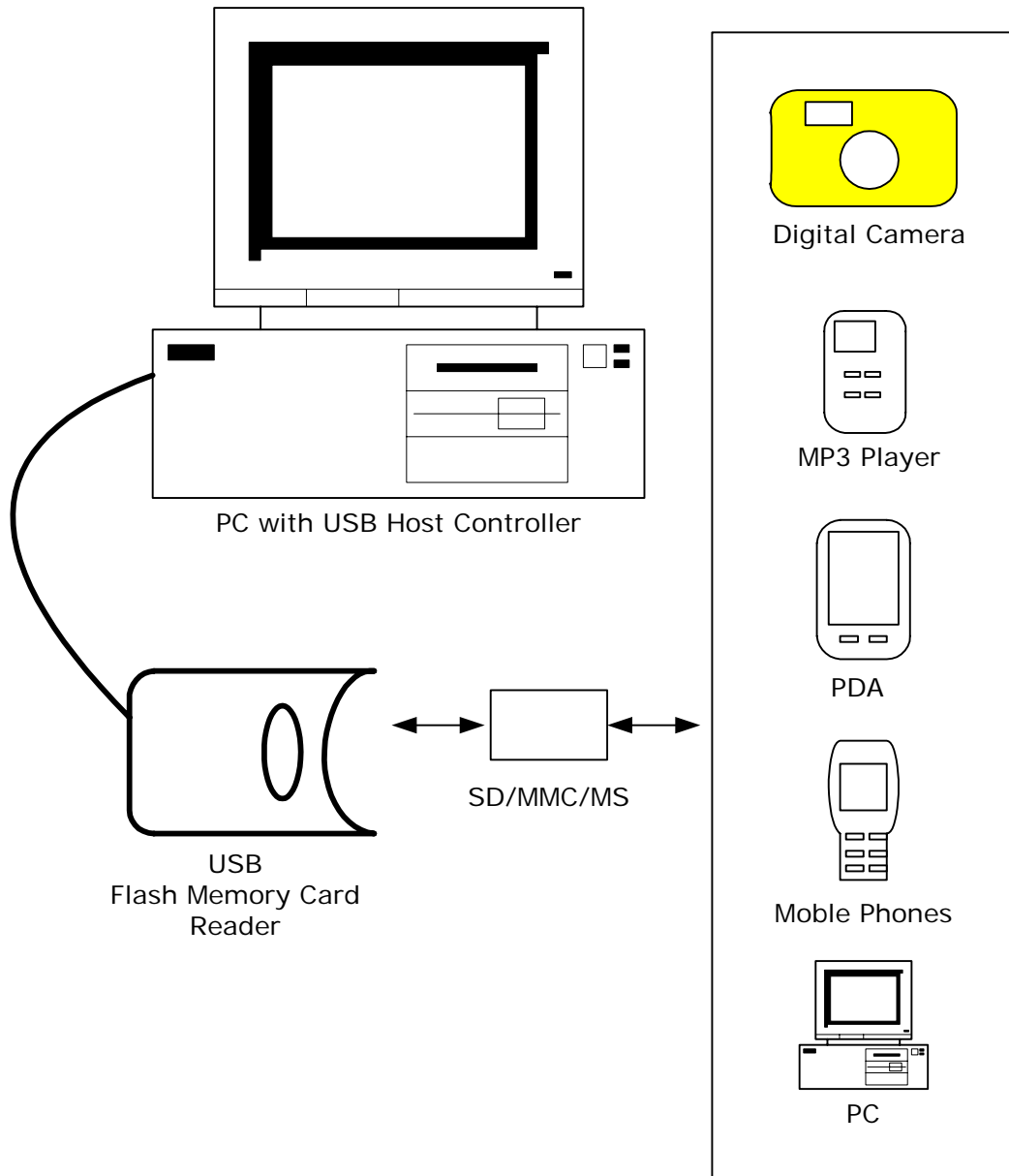



3.0 Pin Assignment

3.1 Pin Assignment Diagram

Figure 3.1 48 Pin Assignment Diagram

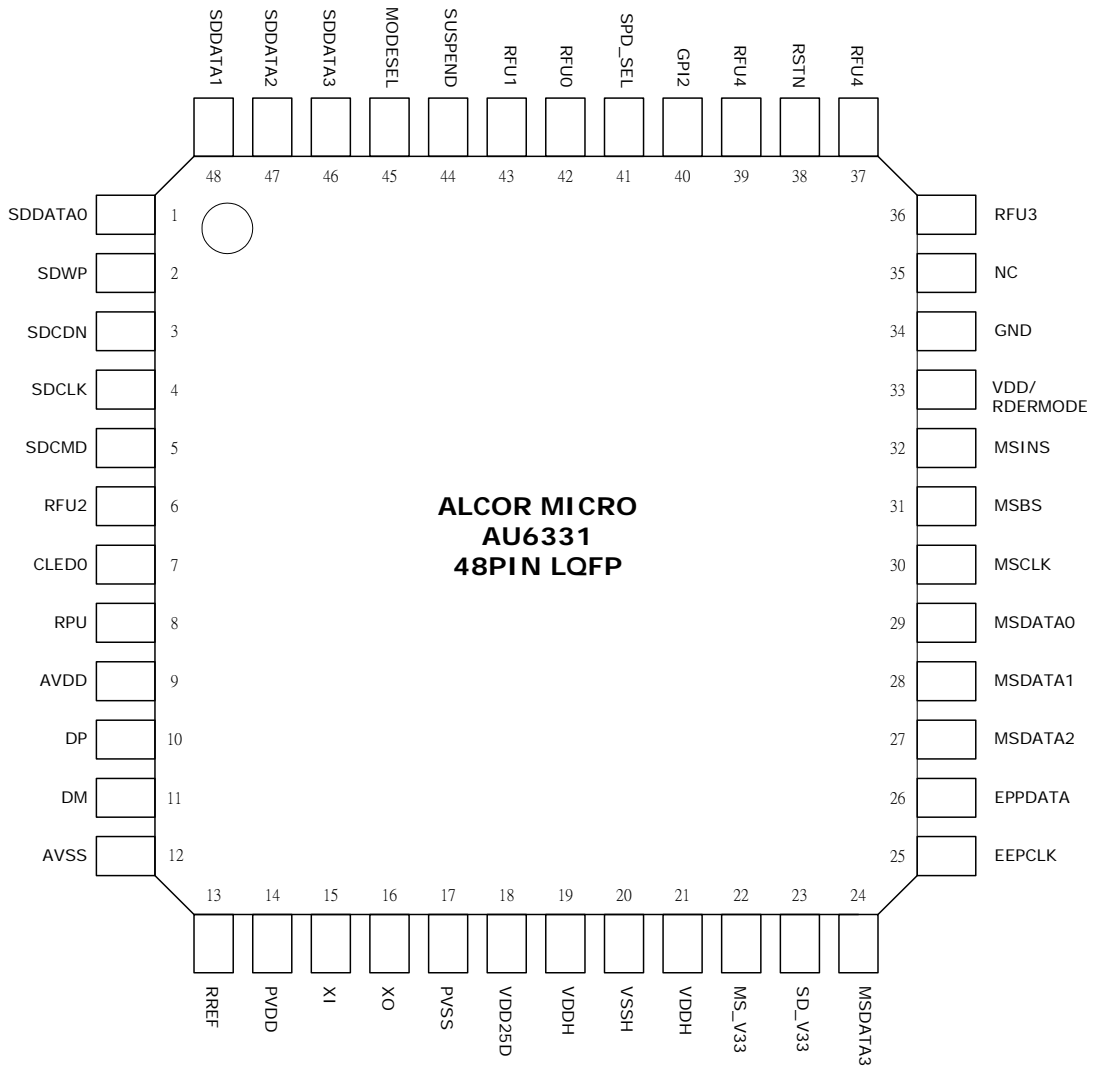



Figure 3.2 28 Pin Assignment Diagram

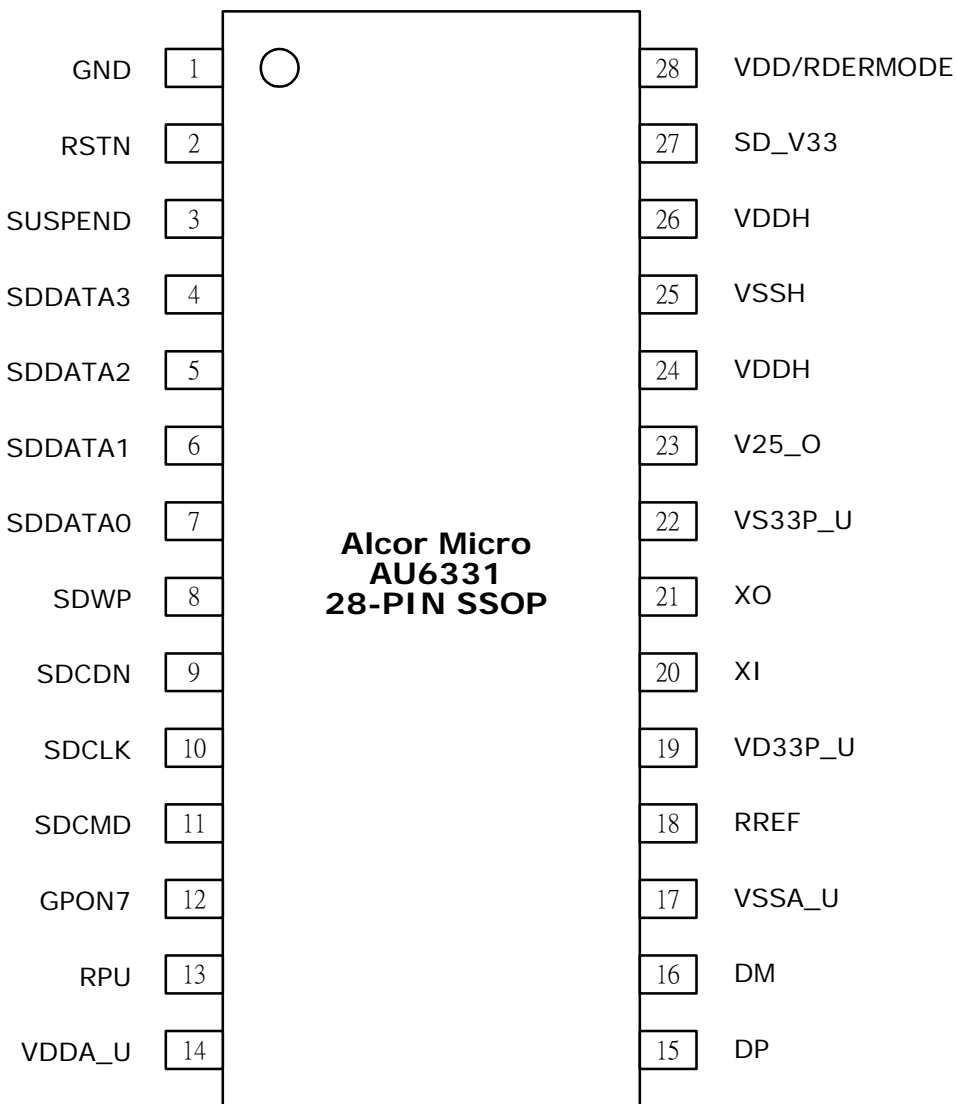



Table 3.1 48 Pin Descriptions

Pin #	Pin Name	I/O	Description
1	SDDATA0	I/O	SD data0
2	SDWP	I	SD write protect; pull up with res.
3	SDCDN	I	SD card Detect ("1": unDetected[Default]; "0": Detected)
4	SDCLK	O	SD CLK
5	SDCMD	I/O	SD CMD; pull up with res.
6	RFU2	I	Always pull low
7	CLEDO	O	LED on for card exists for Full/High Speed
8	RPU	I	Pull up with 1.5K res. To 3.3V VDD
9	AVDD	P	3.3V analog power
10	DP	I/O	DP
11	DM	I/O	DM
12	AVSS	P	Analog Ground
13	RREF	I	Pull down with 1K Res. To AVSS
14	PVDD	P	OSC power 3.3V
15	XI	I	12MHz Oscillator input
16	XO	O	12MHz Oscillator output
17	PVSS	P	OSC ground
18	VDD25D	P	2.5V output for core power
19	VDDH	P	IO power 3.3V
20	VSSH	P	IO ground
21	VDDH	P	IO power 3.3V
22	MS_V33	P	MS card power
23	SD_V33	P	SD card power
24	MSDATA3	I/O	MS data3
25	EEPCLK	O	EEPROM CLK
26	EEPDATA	I/O	EEPROM Data
27	MSDATA2	I/O	MS data2
28	MSDATA1	I/O	MS Data1
29	MSDATA0	I/O	MS Data0
30	MSCLK	O	MS CLK
31	MSBS	O	MS BS
32	MSINS	I	MS card Detect ("1": unDetected[Default]; "0": Detected)



Pin #	Pin Name	I/O	Description
33	VDD / RDERMODE	P	Core power 2.5V / Reader mode("1":Reader mode;"0":Card mode)
34	GND	P	Ground for core
35	NC		
36	RFU3	I	Always pull low
37	RFU4		Reserved
38	RSTN	I	Chip Reset; ("1": Normal[Default]; "0": Reset)
39	RFU4	I	Always pull low
40	GPI2	I	USB current value description ("1": 100mA[Default]; "0": 250mA)
41	SPD_SEL	I	CPU speed selection ("1": 15MHz; "0": 30MHz[Default])
42	RFU0	I	Always pull low
43	RFU1	I	Always pull low
44	SUSPEND	O	Suspend indicator ("1": Suspend; "0": Normal)
45	MODESEL	I	Mode selection ("1": 1 LUN[Default]; "0": 2 LUN)
46	SDDATA3	I/O	SD data3
47	SDDATA2	I/O	SD data2
48	SDDATA1	I/O	SD data1



Table 3.2 28 Pin Descriptions

Pin #	Pin Name	I/O	Description
1	GND	P	Ground for core
2	RSTN	I	Chip Reset; ("1": Normal[Default]; "0": Reset)
3	SUSPEND	O	Suspend indicator ("1": Suspend; "0": Normal)
4	SDDATA3	I/O	SD data3
5	SDDATA2	I/O	SD data2
6	SDDATA1	I/O	SD data1
7	SDDATA0	I/O	SD data0
8	SDWP	I	SD write protect; pull up with res.
9	SDCDN	I	SD card detect ("1": unDetected[Default]; "0": Detected)
10	SDCLK	O	SD CLK
11	SDCMD	I/O	SD CMD; pull up with res.
12	GPON7	O	LED on for card exists for Full/High Speed
13	RPU	I	Pull up with 1.5K res. To 3.3V VDD
14	VDDA_U	P	3.3V analog power
15	DP	I/O	DP
16	DM	I/O	DM
17	VSSA_U	P	Analog Ground
18	RREF	I	Pull down with 1K Res. To AVSS
19	VD33P_U	P	OSC power 3.3V
20	XI	I	12MHz Oscillator input
21	XO	O	12MHz Oscillator output
22	VS33P_U	P	OSC ground
23	V25_O	P	2.5V output for core power
24	VDDH	P	IO power 3.3V
25	VSSH	P	IO ground
26	VDDH	P	IO power 3.3V
27	SD_V33	P	SD card power
28	VDD / RDERMODE	P	Core power 2.5V / Reader mode("1": Reader mode; "0": Card mode)



4.0 System Architecture and Reference Design

4.1 AU6331 Block Diagram

Figure 4.1 AU6331 Block Diagram

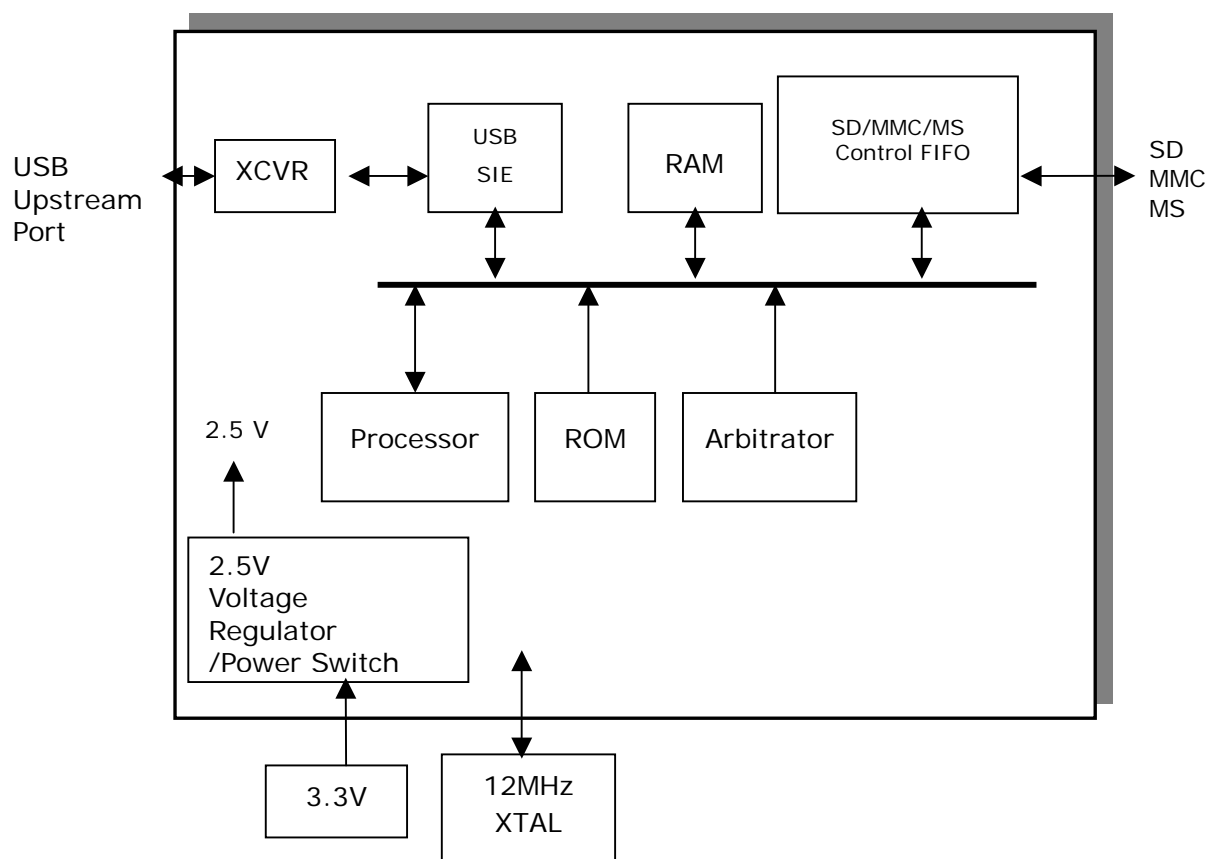



5.0 Electrical Characteristics

5.1 Absolute Maximum Ratings

Table 5.1 Absolute Maximum Ratings

SYMBOL	PARAMETER	RATING	UNITS
V _{CC}	Power Supply	-0.3 to V _{CC} +0.3	V
V _{IN}	Input Signal Voltage	-0.3 to 3.6	V
V _{OUT}	Output Signal Voltage	-0.3 to V _{CC} +0.3	V
T _{STG}	Storage Temperature	-40 to 150	°C

5.2 Recommended Operating Conditions

Table 5.2 Recommended Operating Conditions

SYMBOL	PARAMETER	MIN	TYP	MAX	UNITS
V _{CC}	Power Supply	3.0	3.3	3.6	V
V _{DD}	Digital Supply	2.25	2.5	2.75	V
V _{IN}	Input Signal Voltage	0	3.3	3.6	V
T _{OPR}	Operating Temperature	0	25	115	°C

5.3 Leakage Current and Capacitance

Table 5.3 General DC Characteristics

SYMBOL	PARAMETER	CONDITIONS	MIN	TYP	MAX	UNITS
I _{IN}	Input current	no pull-up or pull-down	-10	±1	10	μA
I _{OZ}	Tri-state leakage current		-10	±1	10	μA
C _{IN}	Input capacitance	Pad Limit		2.8		ρF
C _{OUT}	Output capacitance	Pad Limit		2.8		ρF
C _{BID}	Bi-directional buffer capacitance	Pad Limit		2.8		ρF



5.4 DC Electrical Characteristics of 3.3V I/O Cells

Table 5.4 DC Electrical Characteristics of 3.3V I/O Cells

SYMBOL	PARAMETER	CONDITIONS	Limits			UNIT
			MIN	TYP	MAX	
V_{CC}	Power supply	3.3V I/O	3.0	3.3	3.6	V
V_{il}	Input low voltage	LVTTTL			0.8	V
V_{ih}	Input high voltage		2.0			V
V_{ol}	Output low voltage	$ I_{ol} = 2 \sim 16\text{mA}$			0.4	V
V_{oh}	Output high voltage	$ I_{oh} = 2 \sim 16\text{mA}$	2.4			V
R_{pu}	Input pull-up resistance		40	75	190	$K\Omega$
R_{pd}	Input pull-down resistance		40	75	190	$K\Omega$
I_{in}	Input leakage current	$V_{in} = V_{CC}$ or 0	-10	± 1	10	μA
I_{oz}	Tri-state output leakage current		-10	± 1	10	μA



5.5 USB Transceiver Characteristics

Table 5.5 Electrical characteristics

Symbol	Parameter	Conditions	Min.	Typ.	Max.	Unit
AVCC	Analog supply Voltage		3.0	3.3	3.6	V
VCC	Digital supply Voltage		2.25	2.5	2.75	V
I _{CC}	Operating supply current	High speed operating at 480 MHz			73	mA
I _{CC(susp)}	Suspend supply current	In suspend mode, current with 1.5k Ω pull-up resistor on pin RPU disconnected			120	μ A

Table 5.6 Static characteristic : Digital pin

Symbol	Parameter	Conditions	Min.	Typ.	Max.	Unit
Input levels						
V _{IL}	Low-level input voltage				0.8	V
V _{IH}	High-level input voltage		2.0			V
Output levels						
V _{OL}	Low-level output voltage				0.2	V
V _{OH}	High-level output voltage		VCC-0.2			V

AVCC=3.0V~3.6V ; VCC=2.25V~2.75V ; Temp=0 $^{\circ}$ C~115 $^{\circ}$ C



Table 5.7 Static characteristic : Analog I/O pins (DP/DM)

Symbol	Parameter	Conditions	Min.	Typ.	Max.	Unit
USB2.0 Transceiver (HS)						
Input Levels (differential receiver)						
V_{HSDIFF}	High speed differential input sensitivity	$ V_{I(DP)} - V_{I(DM)} $ measured at the connection as application circuit	300			mV
V_{HSCM}	High speed data signaling common mode voltage range		-50		500	mV
V_{HSSQ}	High speed squelch detection threshold	Squelch detected			100	mV
		No squelch detected	150			mV
V_{HSDSC}	High speed disconnection detection threshold	Disconnection detected	625			mV
		Disconnection not detected			525	mV
Output Levels						
V_{HSOI}	High speed idle level output voltage(differential)		-10		10	mV
V_{HSOL}	High speed low level output voltage(differential)		-10		10	mV
V_{HSOH}	High speed high level output voltage(differential)		-360		400	mV
V_{CHIRPJ}	Chirp-J output voltage (differential)		700		1100	mV
V_{CHIRPK}	Chirp-K output voltage (differential)		-900		-500	mV
Resistance						
R_{DRV}	Driver output impedance	Equivalent resistance used as internal chip only	3	6	9	Ω
		Overall resistance including external resistor	40.5	45	49.5	
Termination						
V_{TERM}	Termination voltage for pull-up resistor on pin RPU		3.0		3.6	V
USB1.1 Transceiver (FS/LS)						
Input Levels (differential receiver)						
V_{DI}	Differential input sensitivity	$ V_{I(DP)} - V_{I(DM)} $	0.2			V
V_{CM}	Differential common mode voltage		0.8		2.5	V
Input Levels (single-ended receivers)						



V_{SE}	Single ended receiver threshold		0.8		2.0	V
Output levels						
V_{OL}	Low-level output voltage		0		0.3	V
V_{OH}	High-level output voltage		2.8		3.6	V

AVCC=3.0V~3.6V ; VCC=2.25V~2.75V ; Temp=0°C~115°C

Table 5.8 Dynamic characteristic : Analog I/O pins (DP/DM)

Symbol	Parameter	Conditions	Min.	Typ.	Max.	Unit
Driver Characteristics						
High-Speed Mode						
t_{HSR}	High-speed differential rise time		500			ps
t_{HSF}	High-speed differential fall time		500			ps
Full-Speed Mode						
t_{FR}	Rise time	CL=50pF ; 10 to 90% of $ V_{OH}-V_{OL} $;	4		20	ns
t_{FF}	Fall time	CL=50pF ; 90 to 10% of $ V_{OH}-V_{OL} $;	4		20	ns
t_{FRMA}	Differential rise/fall time matching (t_{FR} / t_{FF})	Excluding the first transition from idle mode	90		110	%
V_{CRS}	Output signal crossover voltage	Excluding the first transition from idle mode	1.3		2.0	V
Low-Speed Mode						
t_{LR}	Rise time	CL=200pF-600pF ; 10 to 90% of $ V_{OH}-V_{OL} $;	75		300	ns
t_{LF}	Fall time	CL=200pF-600pF ; 90 to 10% of $ V_{OH}-V_{OL} $;	75		300	ns
t_{LRMA}	Differential rise/fall time matching (t_{LR} / t_{LF})	Excluding the first transition from idle mode	80		125	%
V_{CRS}	Output signal crossover voltage	Excluding the first transition from idle mode	1.3		2.0	V
V_{OH}	High-level output voltage		2.8		3.6	V



5.6 Power Switch Feature

AU6331 integrates a 3.3V to 2.5V voltage regulator and power switch to replace all MOS chips for flash card power supply.

Card Power Output Current Range

- For SD/MMC/MS
 - ◆ MAX: 100mA
- Card power output voltage range
 - ◆ SD/MMC/MS: $3.3V \pm 0.3V$
- AU6331 will turn off all of Card Power in suspend mode

Figure 5.1 Card Detect Power-on Timing

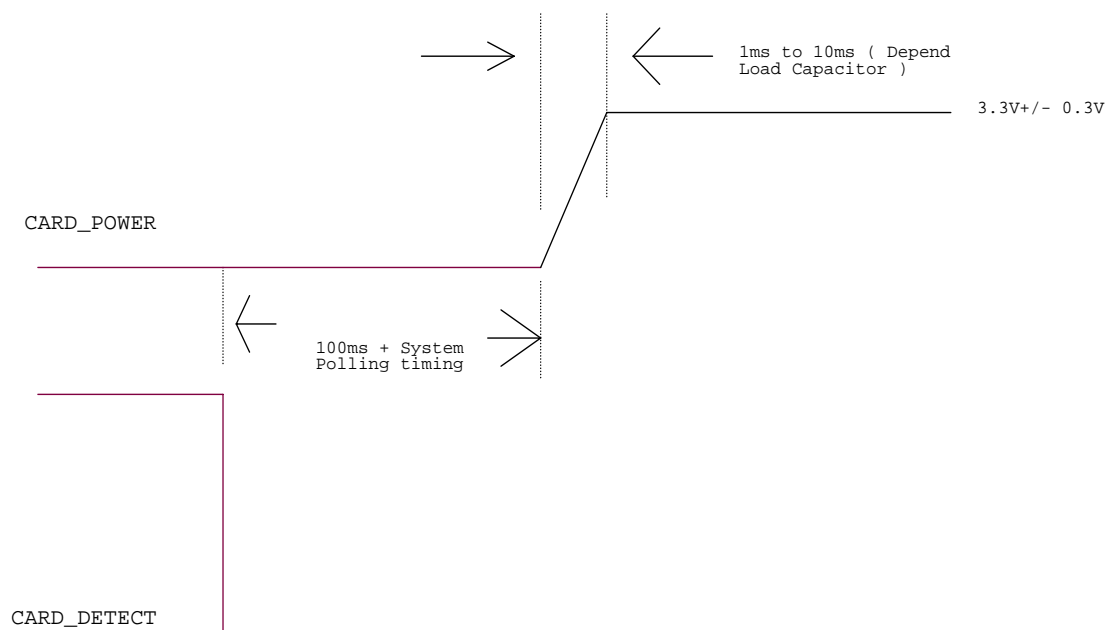



6.0 Mechanical Information

Figure 6.1 48 Pin Mechanical Information Diagram

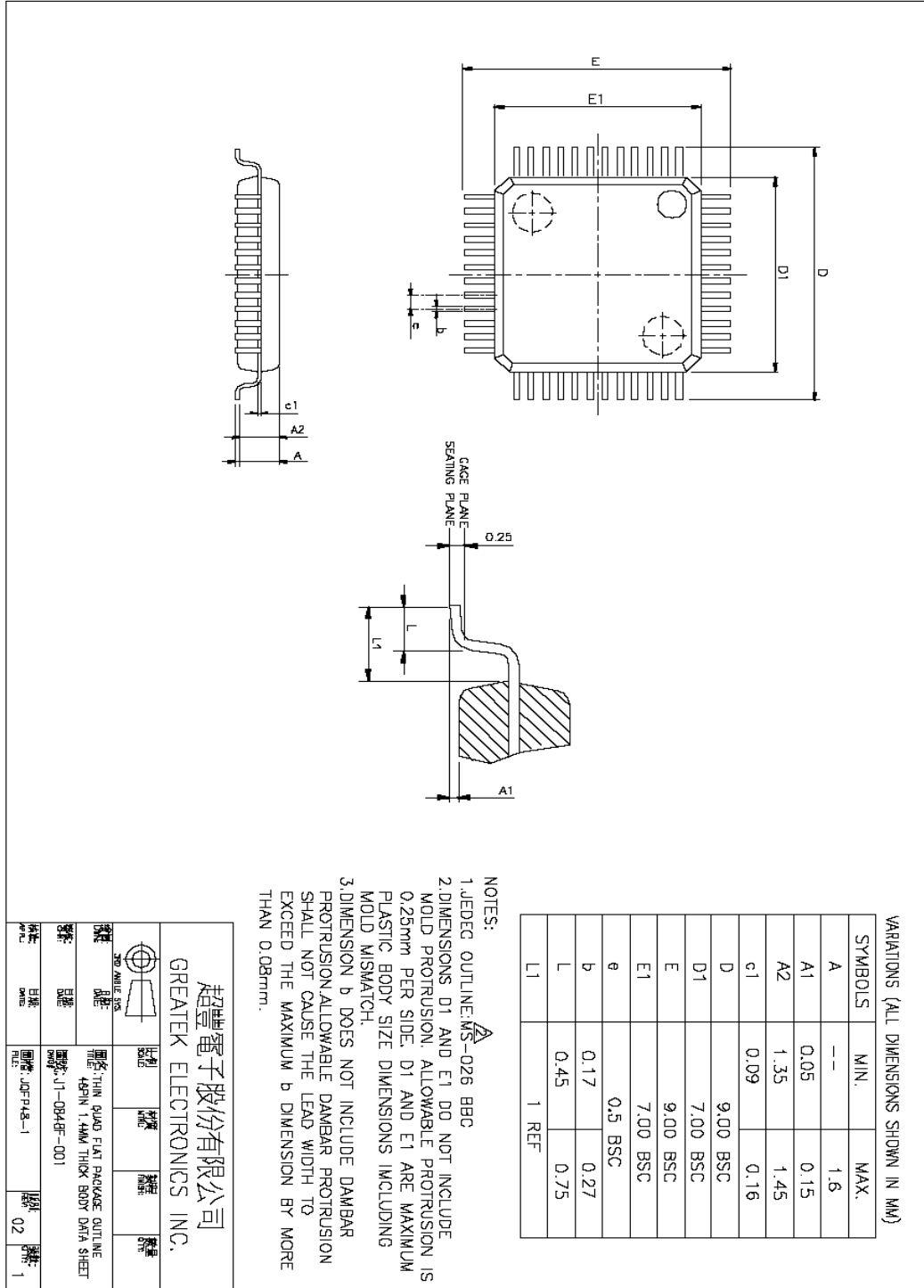
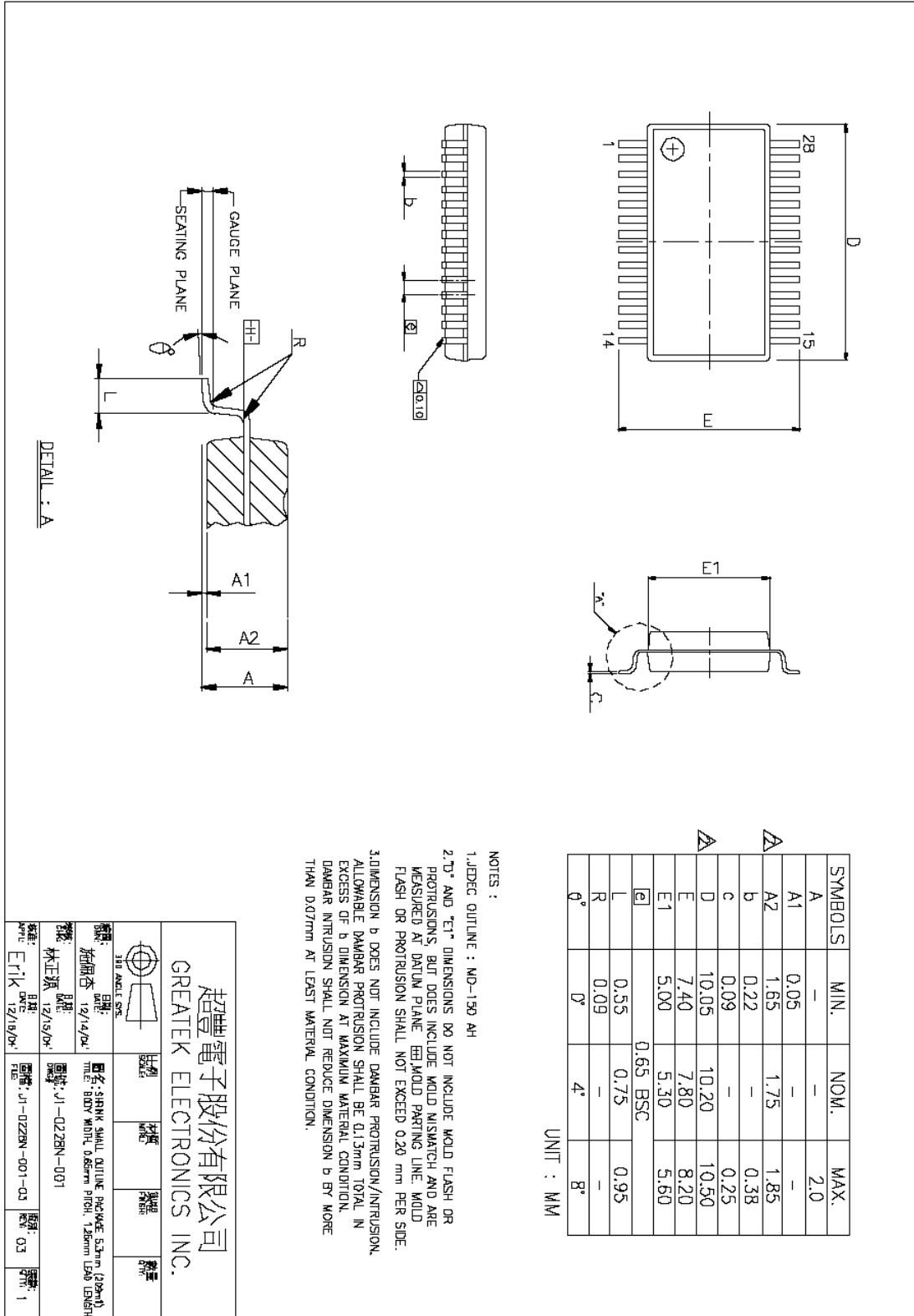
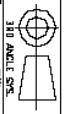



Figure 6.2 28 Pin Mechanical Information Diagram



 超世電子股份有限公司 GREATEK ELECTRONICS INC.			
品名: SHARK SMALL OUTLINE PACKAGE S3mm (200mm ²) THEE: BODY WIDTH: 0.65mm PITCH: 1.25mm LEAD LENGTH	料號: J1-0228N-001	日期: 12/19/04	版次: 03
設計: 林正源	日期: 12/19/04	圖號: J1-0228N-001-03	版次: 03
審核: EIK	日期: 12/19/04	圖號: J1-0228N-001-03	版次: 03



7.0 Abbreviations

This chapter lists and defines terms and abbreviations used throughout this specification.

SIE	Serial Interface Engine
SD	Secure Digital
MMC	Multimedia Card
MS	Memory Stick Card
UTMI	USB Transceiver Macrocell Interface



【MEMO】

About Alcor Micro, Corp

Alcor Micro, Corp. designs, develops and markets highly integrated and advanced peripheral semiconductor, and software driver solutions for the personal computer and consumer electronics markets worldwide. We specialize in USB solutions and focus on emerging technology such as USB and IEEE 1394. The company offers a range of semiconductors including controllers for USB hub, integrated keyboard/USB hub and USB Flash memory card reader...etc. Alcor Micro, Corp. is based in Taipei, Taiwan, with sales offices in Taipei, Japan, Korea and California.

Alcor Micro is distinguished by its ability to provide innovative solutions for spec-driven products. Innovations like single chip solutions for traditional multiple chip products and on-board voltage regulators enable the company to provide cost-efficiency solutions for the computer peripheral device OEM customers worldwide.