

PROGRAMMABLE CURRENT SENSE HIGH SIDE SWITCH

Features

- Load current feedback
- Programmable over current shutdown
- Active clamp
- ESD protection
- Input referenced to Vcc
- Over temperature shutdown
- Reverse battery protection
- Lead-Free

Description

The AUIR3315(S) is a fully protected 4 terminals high side switch. The input signal is referenced to Vcc. When the input voltage $V_{cc} - V_{in}$ is higher than the specified threshold, the output power Mosfet is turned on. When the $V_{cc} - V_{in}$ is lower than the specified V_{il} threshold, the output Mosfet is turned off. A current proportional to the power Mosfet current is sourced to the Ifb pin. Over current shutdown occurs when $V_{ifb} - V_{in} > 4.7V$. The current shutdown threshold is adjusted by selecting the proper R_{ifb}. Either over current and over temperature latches off the switch. The device is reset by pulling the input pin high. Other integrated protections (ESD, reverse battery, active clamp) make the switch very rugged in automotive environment.

Typical Connection

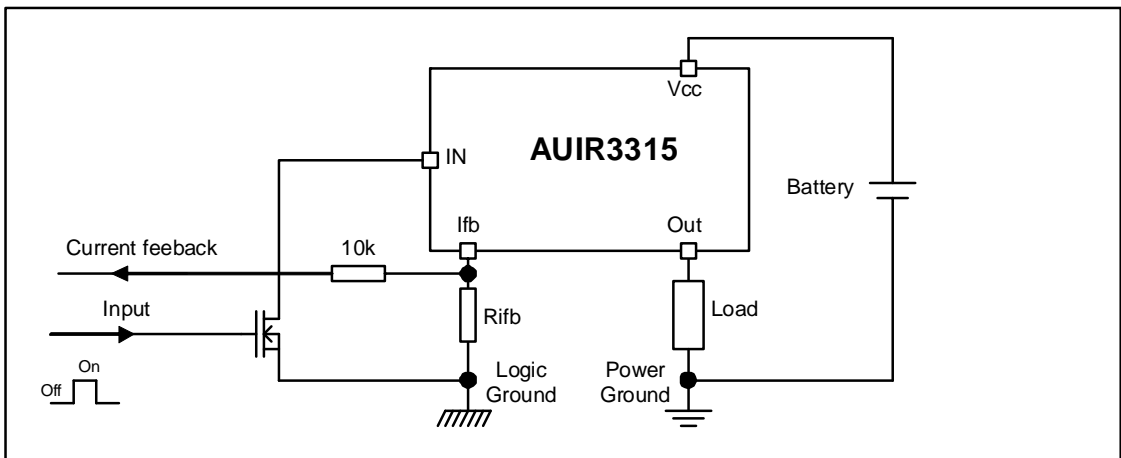

Product Summary

R _{ds(on)}	20 mΩ max.
V _{cc op.}	6 to 32V
Current Ratio	2800
Prog. I _{shutdown}	3 to 30A
V _{clamp}	40V

Packages



TO-220
AUIR3315



D²Pak
Pin 4 and 5 fused
AUIR3315S

Qualification Information†

Qualification Level		Automotive (per AEC-Q100††)	
		Comments: This family of ICs has passed an Automotive qualification. IR's Industrial and Consumer qualification level is granted by extension of the higher Automotive level.	
Moisture Sensitivity Level		D2PAK-5L	MSL1, 260°C (per IPC/JEDEC J-STD-020)
		TO220-5L	Not applicable
ESD	Machine Model	Class M4 (450V) (per AEC-Q100-003)	
	Human Body Model	Class H3A (4,500 V) (per AEC-Q100-002)	
	Charged Device Model	Class C4 (1000 V) (per AEC-Q100-011)	
IC Latch-Up Test		Class II, Level A (per AEC-Q100-004)	
RoHS Compliant		Yes	

† Qualification standards can be found at International Rectifier's web site <http://www.irf.com/>

†† Exceptions to AEC-Q100 requirements are noted in the qualification report.

Absolute Maximum Ratings

Absolute maximum ratings indicate sustained limits beyond which damage to the device may occur. All voltage parameters are referenced to Vcc lead. (Tj=-40°..150°C, Vcc=6..26V Tambient=25°C unless otherwise specified).

Symbol	Parameter	Min.	Max.	Units
Vcc-Vin	Maximum Vcc voltage	-16	37	V
Vcc-Vin cont.	Maximum continuous Vcc voltage	-16	32	
Vcc-Vfb	Maximum lfb voltage	-16	33	
Vcc-Vout	Maximum output voltage	-0.3	37	
I _{ds} cont.	Maximum body diode continuous current Rth=60°C/W (1)	—	2.8	A
I _{ds} pulsed	Maximum body diode pulsed current (1)	—	100	
Pd	Maximum power dissipation Rth=60°C/W	—	2	W
Tj max.	Max. storage & operating temperature junction temperature	-40	150	°C
Min Rfb	Minimum on the resistor on lfb pin	0.3	—	kΩ
I _{fb} max.	Max. lfb current	-50	50	mA

(1) Limited by junction temperature. Pulsed is also limited by wiring

Thermal Characteristics

Symbol	Parameter	Typ.	Max.	Units
Rth1	Thermal resistance junction to ambient D ² -Pak Std footprint	60	—	°C/W
Rth2	Thermal resistance junction to case D ² -Pak	1.6	—	
Rth3	Thermal resistance junction to case TO-220	1.6	—	

Recommended Operating Conditions

These values are given for a quick design. For operation outside these conditions, please consult the application notes.

Symbol	Parameter	Min.	Max.	Units
I _{out}	Continuous output current	—	14	A
	T _{ambient} =85°C, R _{th} =5°C/W, T _j =125°C			
	T _{ambient} =85°C, R _{th} =60°C/W, T _j =125°C			
R _{fb}	Recommended lfb resistor (2)(3)	0.5	3.5	kΩ
Pulse min.	Minimum turn-on pulse width	1	—	ms
F _{max}	Maximum operating frequency	—	200	Hz

(2) If R_{fb} is too low, the device can be damaged.

(3) If R_{fb} is too high, the device may not switch on.

Protection Characteristics

T_j=-40°..150°C, V_{cc}=6..26V, R_{ifb}=500 to 5kΩ

Symbol	Parameter	Min.	Typ.	Max.	Units	Test Conditions
V _{ifb-Vin@I_{sd}}	Over-current shutdown threshold	3.8	4.7	5.9	V	
T _{sd}	Over temperature threshold	—	165	—	°C	See fig. 5
OV	Over voltage protection (not latched)	33	35	39	V	
I _{sd} f	Fixed over current shutdown	30	38	50	A	V _{ifb} <V _{ifb-Vin@I_{sd}} R _{ifb} =1kΩ
I _{sd_1k}	Programmable over current shutdown 1k	9	12	17		
t _{reset}	Time to reset protection	—	50	500	μs	See fig. 5
Min. pulse	Min. pulse width (no WAIT state)	150	400	1200		T _j =25°C
WAIT	WAIT function timer	0.4	1	2	ms	See fig. 4 and 5
R _{ds(on) rev.}	Reverse battery On state resistance	—	16	28	mΩ	V _{cc-Vin} =-14V, I _{out} =10A
	T _j =25°C	—	24	42		
	T _j =125°C	—	24	42		

Static Electrical Characteristics

T_j=25°C, V_{cc}=14V (unless otherwise specified)

Symbol	Parameter	Min.	Typ.	Max.	Units	Test Conditions
V _{cc op.}	Operating Voltage range	6	—	32	V	
I _{cc off}	Supply leakage current	—	1.5	5	μA	V _{in} =V _{cc} , V _{cc-Vout} =14V, V _{cc-Vifb} =14V, T _j =25°C
I _{in, on}	On state I _N positive current	1.5	3	6	mA	V _{cc-Vin} =14V, T _j =25°C
V _{ih}	High level Input threshold voltage (4)	—	5.4	6.3	V	
V _{il}	Low level Input threshold voltage (4)	4	4.9	5.8	V	
V _{hyst}	Input hysteresis V _{ih} -V _{il}	0.2	0.4	1.5		
I _{out}	Drain to source leakage current	—	1.2	5	μA	V _{in} =V _{cc} , V _{cc-Vifb} =0V, V _{cc-Vout} =14V, T _j =25°C
R _{ds(on)}	On state resistance (5) T _j =25°C	10	15	20	mΩ	I _{out} =10A, V _{cc-Vin} =14V
	On state resistance (5) T _j =25°C	10	16	28		I _{out} =7A, V _{cc-Vin} =6V
	On state resistance (5) T _j =150°C	20	28.5	38		I _{out} =10A, V _{cc-Vin} =14V
V _{clamp1}	V _{cc} to V _{out} clamp voltage 1	36	39	—	V	I _{out} =50mA
V _{clamp2}	V _{cc} to V _{out} clamp voltage 2	—	40	43	V	I _{out} =10A, T _j =25°C

(4) Input thresholds are measured directly between the input pin and the tab. Any parasitic resistance in common between the load current path and the input signal path can significantly affect the thresholds.

(5) R_{ds(on)} is measured between the tab and the Out pin, 5mm away from the package.

Switching Electrical Characteristics

V_{cc}=14V, Resistive load=4Ω, T_j=25°C

Symbol	Parameter	Min.	Typ.	Max.	Units	Test Conditions
t _{don}	Turn on delay time to 10% V _{cc}	3	11	27	μs	See figure 2
t _{r1}	Rise time to V _{cc-Vout} =5V	1	4	10		
t _{r2}	Rise time to V _{cc-Vout} =0.1V _{cc}	2	8	20		
E _{on}	Turn on energy	—	0.2	—	mJ	
t _{doff}	Turn off delay time	10	40	100	μs	
t _f	Fall time to V _{out} =10% of V _{cc}	2	8	20		
E _{off}	Turn off energy	—	0.1	—		

Current Sense Characteristics

$T_j = -40^{\circ}\text{C}..150^{\circ}\text{C}$, $V_{cc} = 6..26\text{V}$ (unless otherwise specified)

Symbol	Parameter	Min.	Typ.	Max.	Units	Test Conditions
Ratio	I Load/I _{fb} current ratio	2,400	2,800	3,200	—	R _{fb} =500Ω, I _{out} =20A
Ratio_TC	I Load/I _{fb} variation aver temperature	-5	—	+5	%	T _j =-40°C to 150°C
Offset	Load current diagnostic offset	-0.08	0	+0.09	A	I _{out} =1A
trst	I _{fb} response time (low signal)	—	1	—	μs	90% of the I _{out} step

Functional Block Diagram

All values are typical

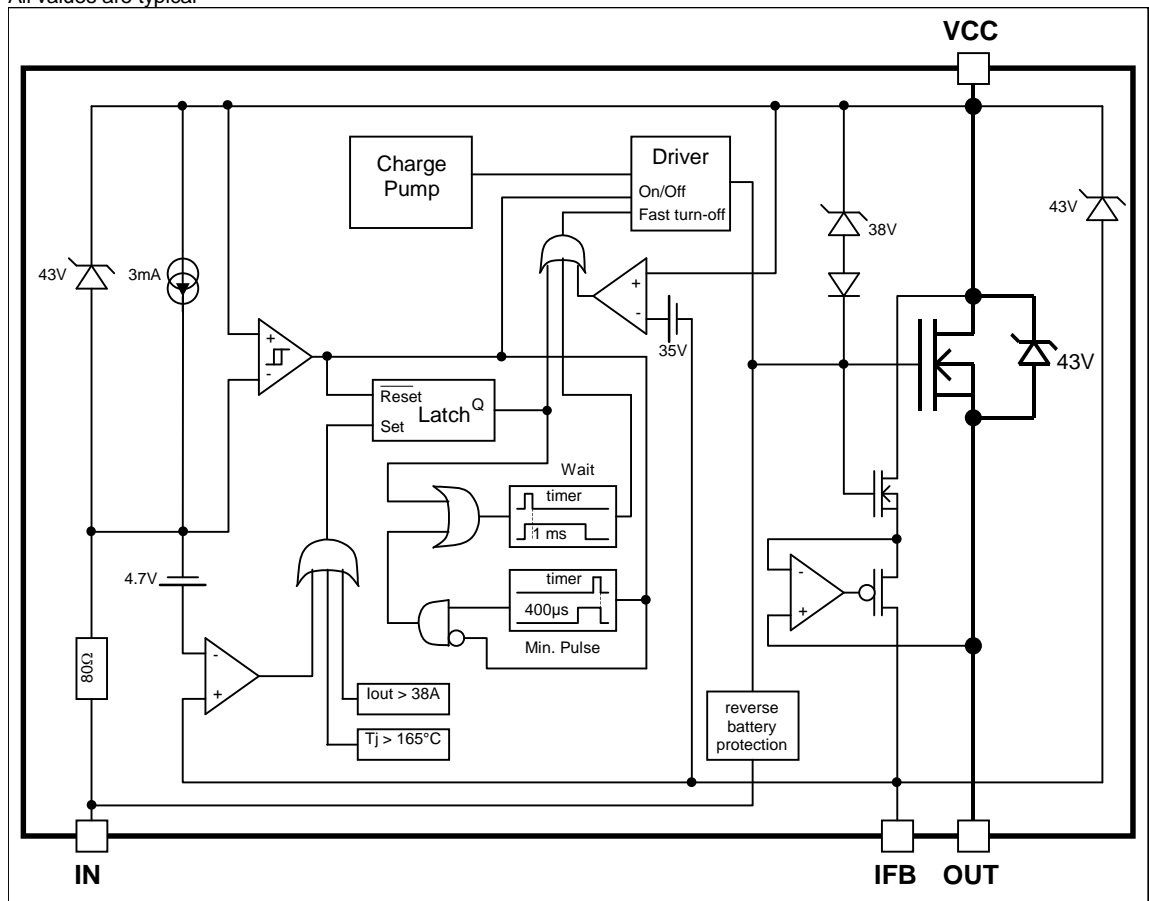

Lead Assignments

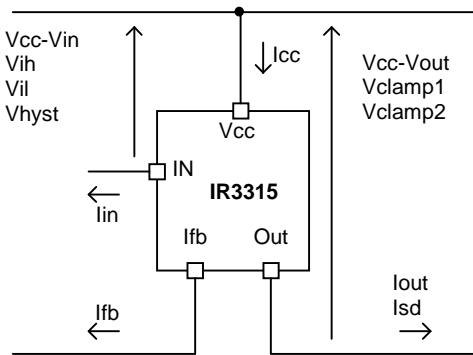
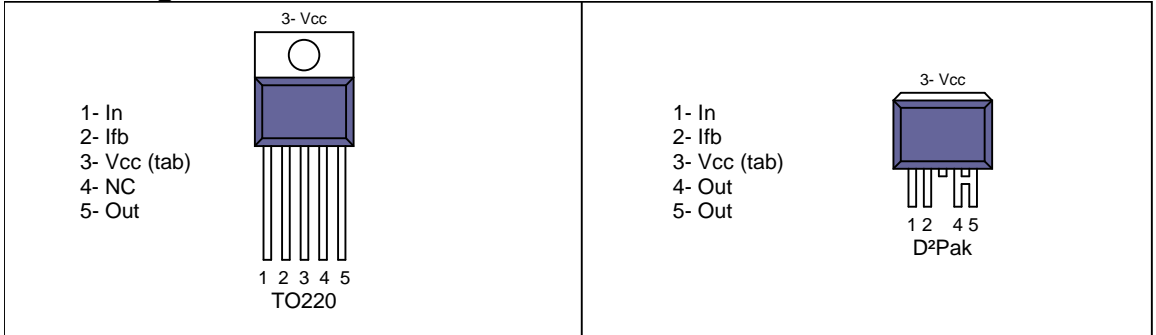

Figure 1 – Voltages and current definitions

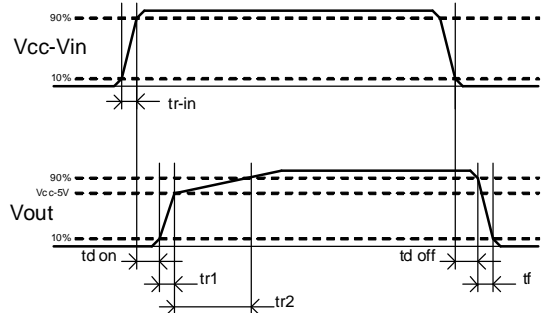

Figure 2 – Switching time definitions

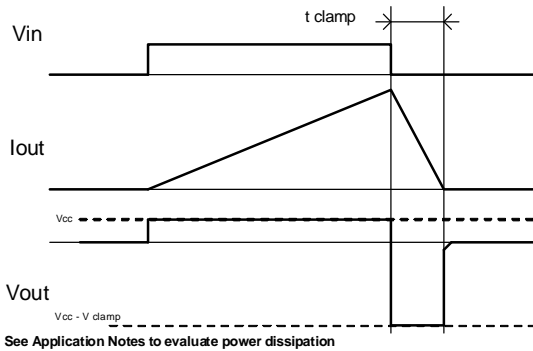

Figure 3 – Active clamp waveforms

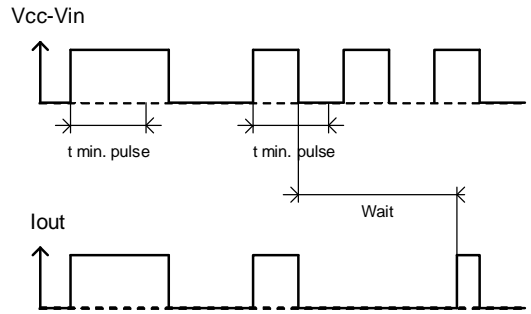

Figure 4 – Min. pulse and Wait function



Figure 5 – Protection Timing Diagrams

All curves are typical characteristics. Operation in hatched areas is not recommended. $T_j=25^\circ\text{C}$, $R_{\text{th}}=500\text{ohm}$, $V_{\text{cc}}=14\text{V}$ (unless otherwise specified).

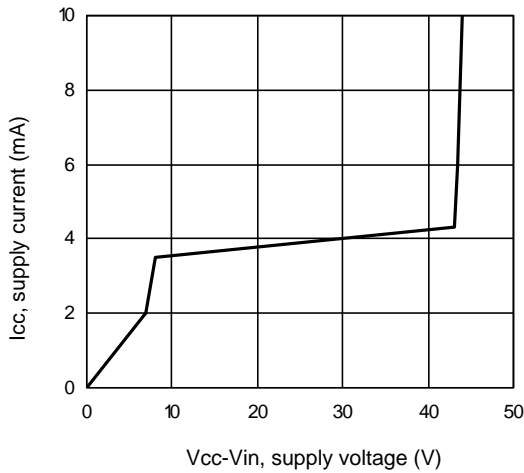

Figure 6 – Icc (mA) Vs Vcc-Vin (V)

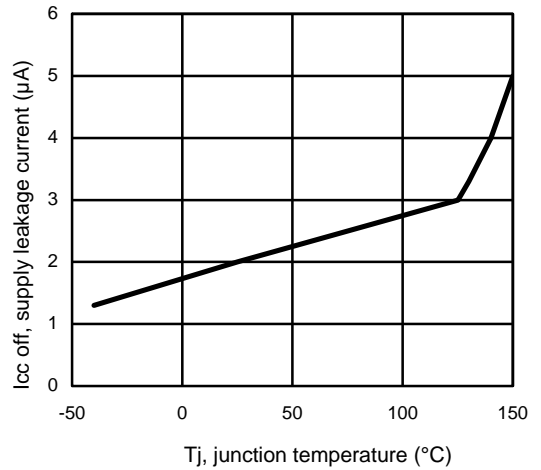

Figure 7 – Icc off (µA) Vs Tj (°C)

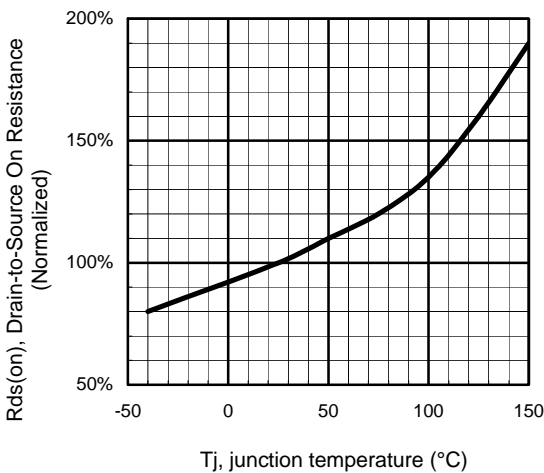

Figure 8 - Normalized Rds(on) (%) Vs Tj (°C)

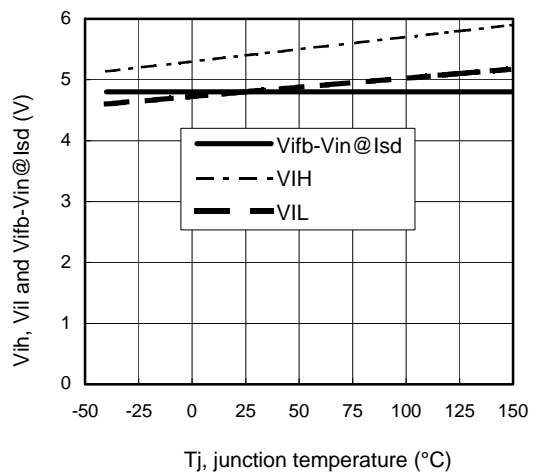

Figure 9 – Vih, Vil and Vifb-Vin@Isd (V) Vs Tj (°C)

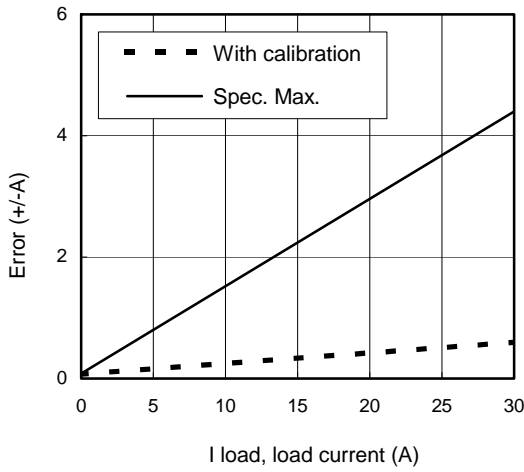

Figure 10 – Error (+/- A) Vs I load (A)

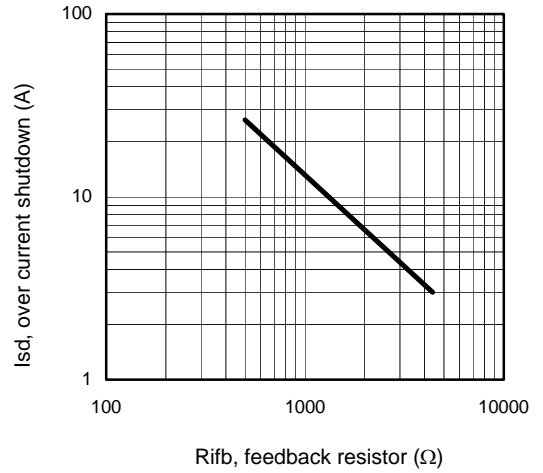

Figure 11 – Ids (A) Vs Rifb (Ω)

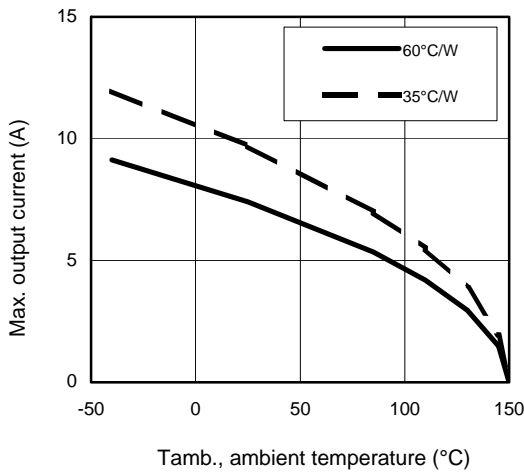

Figure 12 – Max. iout (A) Vs Tamb. (°C)

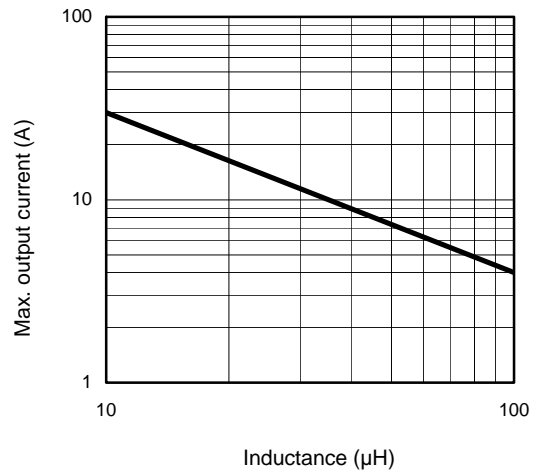

Figure 13 – Max. iout (A) Vs inductance (μH)

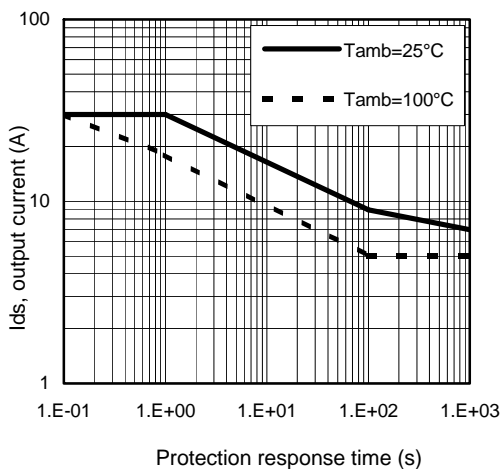

Figure 14 – I_{ds} (A) Vs over temperature protection response time (s)

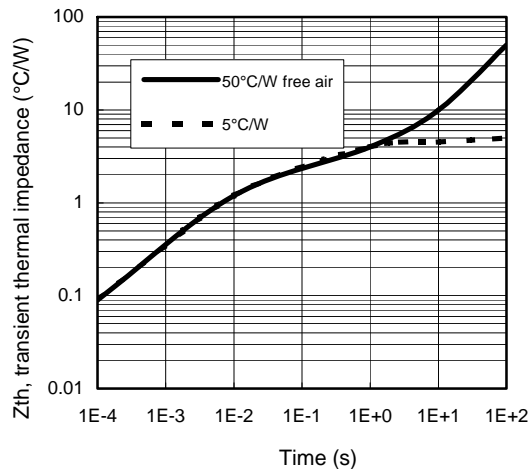
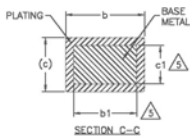
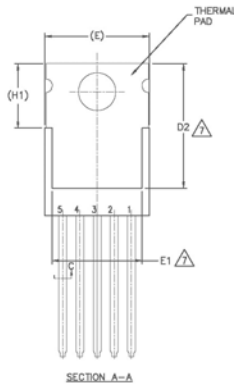
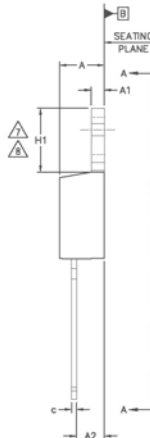
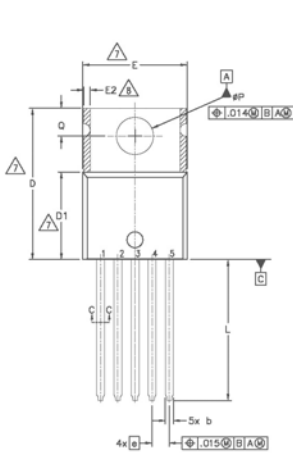

Figure 15 – Transient thermal impedance ($^{\circ}\text{C}/\text{W}$) Vs time (s)

Case Outline – TO220 5 leads



DIMENSIONS	DIMENSIONS				NOTES
	MILLIMETERS		INCHES		
	MIN.	MAX.	MIN.	MAX.	
A	3.56	4.83	.140	.190	
A1	0.51	1.40	.020	.055	
A2	2.03	2.92	.080	.115	
b	0.84	0.89	.025	.035	5
b1	0.64	0.84	.025	.033	
c	0.36	0.61	.014	.024	
c1	0.36	0.56	.014	.022	5
D	14.22	16.51	.560	.650	4
D1	8.38	9.02	.330	.355	
D2	11.68	12.88	.460	.507	7
E	9.65	10.67	.380	.420	4,7
E1	6.86	8.89	.270	.350	7
E2	—	0.76	—	.030	8
e	1.70 BSC		.067 BSC		
H1	5.84	6.86	.230	.270	7,8
L	12.70	14.73	.500	.580	
L	3.53	3.73	.139	.147	
Q	2.54	3.05	.100	.120	

NOTES:

- 1.- DIMENSIONING AND TOLERANCING AS PER ASME Y14.5 M- 1994.
- 2.- DIMENSIONS ARE SHOWN IN INCHES [MILLIMETERS].
- 3.- LEAD DIMENSION AND FINISH UNCONTROLLED IN L1.
- 4.- DIMENSION D, D1 & E DO NOT INCLUDE MOLD FLASH. MOLD FLASH SHALL NOT EXCEED .005" (0.127) PER SIDE. THESE DIMENSIONS ARE MEASURED AT THE OUTERMOST EXTREMES OF THE PLASTIC BODY.
- 5.- DIMENSION b1 & c1 APPLY TO BASE METAL ONLY.
- 6.- CONTROLLING DIMENSION - INCHES.
- 7.- THERMAL PAD CONTOUR OPTIONAL WITHIN DIMENSIONS E,H1,D2 & E1
- 8.- DIMENSION E2 X H1 DEFINE A ZONE WHERE STAMPING AND SINGULATION IRREGULARITIES ARE ALLOWED.
- 9.- OUTLINE CONFORMS TO JEDEC TO-220, EXCEPT A2 (max.) AND D2 (min.) WHERE DIMENSIONS ARE DERIVED FROM THE ACTUAL PACKAGE OUTLINE.
- 10.- LEADS AND DRAIN ARE PLATED WITH 100% Sn

Case Outline - D2PAK - 5 Leads

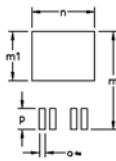
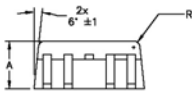
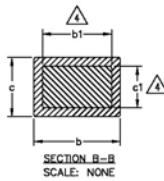
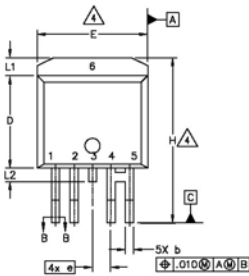
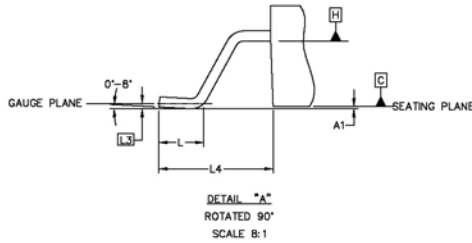
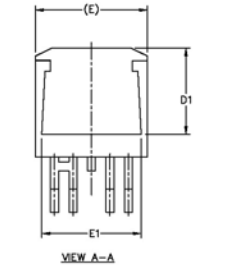

SYMBO L	DIMENSIONS				NOTES
	MILLIMETERS		INCHES		
	MIN.	MAX.	MIN.	MAX.	
A	4.06	4.83	.160	.190	
A1		0.254		.010	
b	0.66	0.91	.026	.036	4
b1	0.66	0.81	.026	.032	
c	0.38	0.74	.015	.029	
c1	0.38	0.58	.015	.023	4
c2	1.14	1.65	.045	.065	
D	8.51	9.65	.335	.380	3
D1	6.86		.270		
E	9.65	10.67	.380	.420	3
E1	6.22		.245		
e	1.70	BSC	.067	BSC	
H	14.73	15.49	.580	.609	
L	1.14	1.39	.045	.055	
L1		1.65		.065	
L2	1.27	1.78	.050	.070	
L3		0.25	BSC	.010	BSC
L4	4.78	5.28	.188	.208	
m	17.78		.700		
m1	8.89		.350		
n	11.43		.450		
o	1.93		.076		
p	3.81		.150		
R	0.51	0.71	.020	.028	

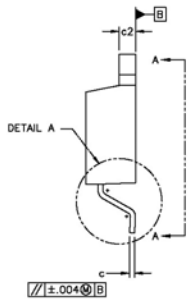

NOTES:

1. DIMENSIONING AND TOLERANCING PER ASME Y14.5M-1994
2. DIMENSIONS ARE SHOWN IN MILLIMETERS [INCHES].
3. DIMENSION D & E DO NOT INCLUDE MOLD FLASH. MOLD FLASH SHALL NOT EXCEED 0.127 [0.005"] PER SIDE. THESE DIMENSIONS ARE MEASURED AT THE OUTMOST EXTREMES OF THE PLASTIC BODY.
4. DIMENSION b1 AND c1 APPLY TO BASE METAL ONLY.
5. CONTROLLING DIMENSION: MILLIMETERS
6. LEADS AND DRAIN ARE PLATED WITH 100% Sn

Tape & Reel - D2PAK – 5 leads



- NOTES:
1. VENDOR: OPTIONAL
 2. REEL MUST HAVE ANTI-STATIC COATING SURFACE RESISTIVITY OF REEL (AS PER EIA-541) μin : 10^9 ohm/SQUARE ; MAX $10^{12} \text{ ohm/SQUARE}$
 3. REEL MUST ALSO MEET REQUIREMENTS OF EIA STANDARD # EIA-481A, TAPING OF SURFACE-MOUNT COMPONENTS FOR AUTOMATIC PLACEMENT.
 4. THE BOX OF PACKING MUST CONTAIN THE REELS INSIDE AN ANTI-STATIC BAG.
 5. (C) CRITICAL

Part Marking Information

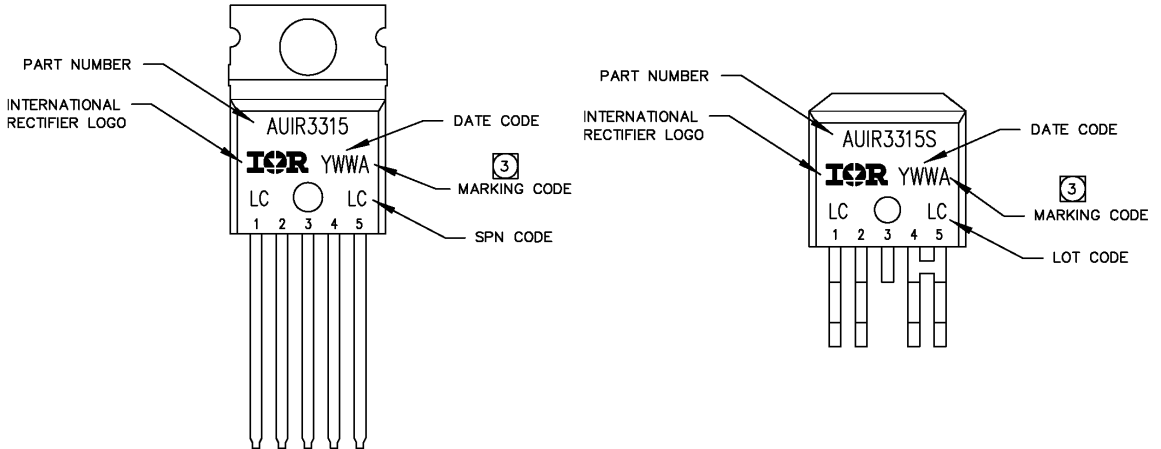

Ordering Information

Base Part Number	Package Type	Standard Pack		Complete Part Number
		Form	Quantity	
AUIR3315	TO220 – 5Leads	Tube	50	AUIR3315
	D2-Pak-5-Leads	Tube	50	AUIR3315S
		Tape and reel left	800	AUIR3315STRL
		Tape and reel right	800	AUIR3315STRR

IMPORTANT NOTICE

Unless specifically designated for the automotive market, International Rectifier Corporation and its subsidiaries (IR) reserve the right to make corrections, modifications, enhancements, improvements, and other changes to its products and services at any time and to discontinue any product or services without notice. Part numbers designated with the "AU" prefix follow automotive industry and / or customer specific requirements with regards to product discontinuance and process change notification. All products are sold subject to IR's terms and conditions of sale supplied at the time of order acknowledgment.

IR warrants performance of its hardware products to the specifications applicable at the time of sale in accordance with IR's standard warranty. Testing and other quality control techniques are used to the extent IR deems necessary to support this warranty. Except where mandated by government requirements, testing of all parameters of each product is not necessarily performed.

IR assumes no liability for applications assistance or customer product design. Customers are responsible for their products and applications using IR components. To minimize the risks with customer products and applications, customers should provide adequate design and operating safeguards.

Reproduction of IR information in IR data books or data sheets is permissible only if reproduction is without alteration and is accompanied by all associated warranties, conditions, limitations, and notices. Reproduction of this information with alterations is an unfair and deceptive business practice. IR is not responsible or liable for such altered documentation. Information of third parties may be subject to additional restrictions.

Resale of IR products or serviced with statements different from or beyond the parameters stated by IR for that product or service voids all express and any implied warranties for the associated IR product or service and is an unfair and deceptive business practice. IR is not responsible or liable for any such statements.

IR products are not designed, intended, or authorized for use as components in systems intended for surgical implant into the body, or in other applications intended to support or sustain life, or in any other application in which the failure of the IR product could create a situation where personal injury or death may occur. Should Buyer purchase or use IR products for any such unintended or unauthorized application, Buyer shall indemnify and hold International Rectifier and its officers, employees, subsidiaries, affiliates, and distributors harmless against all claims, costs, damages, and expenses, and reasonable attorney fees arising out of, directly or indirectly, any claim of personal injury or death associated with such unintended or unauthorized use, even if such claim alleges that IR was negligent regarding the design or manufacture of the product.

IR products are neither designed nor intended for use in military/aerospace applications or environments unless the IR products are specifically designated by IR as military-grade or "enhanced plastic." Only products designated by IR as military-grade meet military specifications. Buyers acknowledge and agree that any such use of IR products which IR has not designated as military-grade is solely at the Buyer's risk, and that they are solely responsible for compliance with all legal and regulatory requirements in connection with such use.

IR products are neither designed nor intended for use in automotive applications or environments unless the specific IR products are designated by IR as compliant with ISO/TS 16949 requirements and bear a part number including the designation "AU". Buyers acknowledge and agree that, if they use any non-designated products in automotive applications, IR will not be responsible for any failure to meet such requirements.

For technical support, please contact IR's Technical Assistance Center

<http://www.irf.com/technical-info/>

WORLD HEADQUARTERS:

233 Kansas St., El Segundo, California 90245

Tel: (310) 252-7105

Revision History

Revision	Date	Notes/Changes
A	01/09/2006	First release
B	22/01/2007	Pin asignment
C	14/01/2010	AU release
D	14/11/2010	Change description