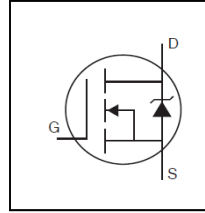
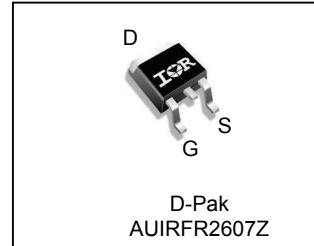


**Features**

- Advanced Process Technology
- Ultra Low On-Resistance
- 175°C Operating Temperature
- Fast Switching
- Repetitive Avalanche Allowed up to Tjmax
- Lead-Free, RoHS Compliant
- Automotive Qualified \*



$V_{DSS}$		<b>75V</b>
$R_{DS(on)}$	<b>typ.</b>	<b>17.6mΩ</b>
	<b>max.</b>	<b>22mΩ</b>
$I_D$ (Silicon Limited)		<b>45A<sup>Ⓢ</sup></b>
$I_D$ (Package Limited)		<b>42A</b>



<b>G</b>	<b>D</b>	<b>S</b>
Gate	Drain	Source

**Description**

Specifically designed for Automotive applications, this HEXFET<sup>®</sup> Power MOSFET utilizes the latest processing techniques to achieve extremely low on-resistance per silicon area. Additional features of this design are a 175°C junction operating temperature, fast switching speed and improved repetitive avalanche rating. These features combine to make this design an extremely efficient and reliable device for use in Automotive applications and a wide variety of other applications.

Base part number	Package Type	Standard Pack		Orderable Part Number
		Form	Quantity	
AUIRFR2607Z	D-Pak	Tube	75	AUIRFR2607Z
		Tape and Reel Left	3000	AUIRFR2607ZTRL

**Absolute Maximum Ratings**

Stresses beyond those listed under “Absolute Maximum Ratings” may cause permanent damage to the device. These are stress ratings only; and functional operation of the device at these or any other condition beyond those indicated in the specifications is not implied. Exposure to absolute-maximum-rated conditions for extended periods may affect device reliability. The thermal resistance and power dissipation ratings are measured under board mounted and still air conditions. Ambient temperature (TA) is 25°C, unless otherwise specified.

Symbol	Parameter	Max.	Units
$I_D @ T_C = 25^\circ C$	Continuous Drain Current, $V_{GS} @ 10V$ (Silicon Limited)	45 <sup>Ⓢ</sup>	A
$I_D @ T_C = 100^\circ C$	Continuous Drain Current, $V_{GS} @ 10V$ (Silicon Limited)	32	
$I_D @ T_C = 25^\circ C$	Continuous Drain Current, $V_{GS} @ 10V$ (Package Limited)	42	
$I_{DM}$	Pulsed Drain Current <sup>①</sup>	180	
$P_D @ T_C = 25^\circ C$	Maximum Power Dissipation	110	W
	Linear Derating Factor	0.72	W/°C
$V_{GS}$	Gate-to-Source Voltage	± 20	V
$E_{AS}$	Single Pulse Avalanche Energy (Thermally Limited) <sup>②</sup>	96	mJ
$E_{AS}$ (Tested)	Single Pulse Avalanche Energy Tested Value <sup>③</sup>	96	
$I_{AR}$	Avalanche Current <sup>①</sup>	See Fig.15,16, 12a, 12b	A
$E_{AR}$	Repetitive Avalanche Energy <sup>⑤</sup>		mJ
$T_J$	Operating Junction and Storage Temperature Range	-55 to + 175	°C
$T_{STG}$			

**Thermal Resistance**

Symbol	Parameter	Typ.	Max.	Units
$R_{\theta JC}$	Junction-to-Case <sup>⑥</sup>	—	1.38	°C/W
$R_{\theta JA}$	Junction-to-Ambient ( PCB Mount) <sup>⑦</sup>	—	50	
$R_{\theta JA}$	Junction-to-Ambient	—	110	

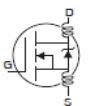
HEXFET<sup>®</sup> is a registered trademark of Infineon.

\*Qualification standards can be found at [www.infineon.com](http://www.infineon.com)

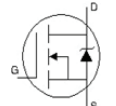
**Static @ T<sub>J</sub> = 25°C (unless otherwise specified)**

	Parameter	Min.	Typ.	Max.	Units	Conditions
V <sub>(BR)DSS</sub>	Drain-to-Source Breakdown Voltage	75	—	—	V	V <sub>GS</sub> = 0V, I <sub>D</sub> = 250μA
ΔV <sub>(BR)DSS</sub> /ΔT <sub>J</sub>	Breakdown Voltage Temp. Coefficient	—	0.074	—	V/°C	Reference to 25°C, I <sub>D</sub> = 1mA
R <sub>DS(on)</sub>	Static Drain-to-Source On-Resistance	—	17.6	22	mΩ	V <sub>GS</sub> = 10V, I <sub>D</sub> = 30A ③
V <sub>GS(th)</sub>	Gate Threshold Voltage	2.0	—	4.0	V	V <sub>DS</sub> = V <sub>GS</sub> , I <sub>D</sub> = 50μA
g <sub>fs</sub>	Forward Trans conductance	36	—	—	S	V <sub>DS</sub> = 25V, I <sub>D</sub> = 30A
I <sub>DSS</sub>	Drain-to-Source Leakage Current	—	—	20	μA	V <sub>DS</sub> = 75 V, V <sub>GS</sub> = 0V
		—	—	250	μA	V <sub>DS</sub> = 75V, V <sub>GS</sub> = 0V, T <sub>J</sub> = 125°C
I <sub>GSS</sub>	Gate-to-Source Forward Leakage	—	—	200	nA	V <sub>GS</sub> = 20V
	Gate-to-Source Reverse Leakage	—	—	-200	nA	V <sub>GS</sub> = -20V

**Dynamic Electrical Characteristics @ T<sub>J</sub> = 25°C (unless otherwise specified)**

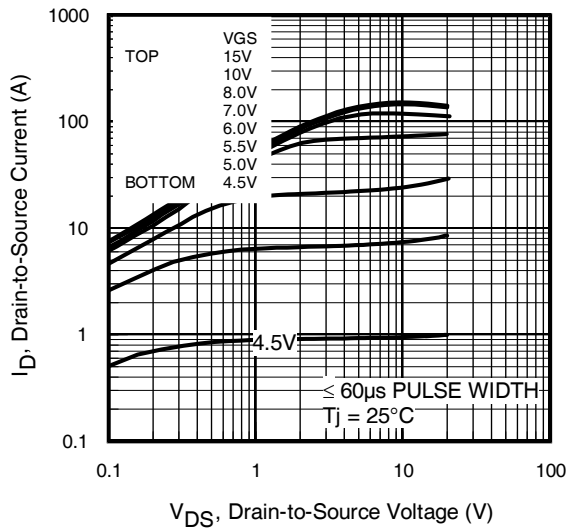
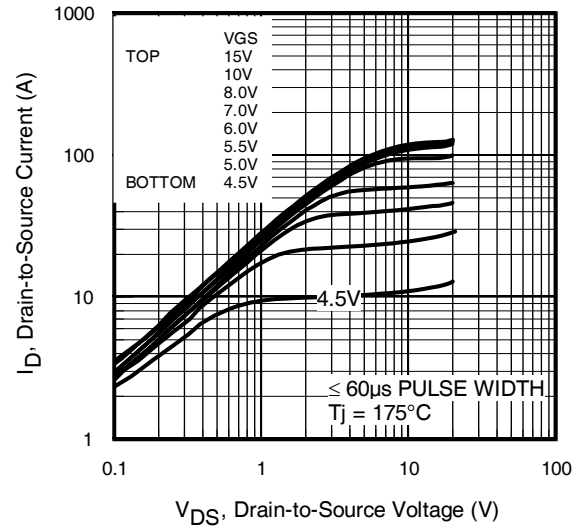
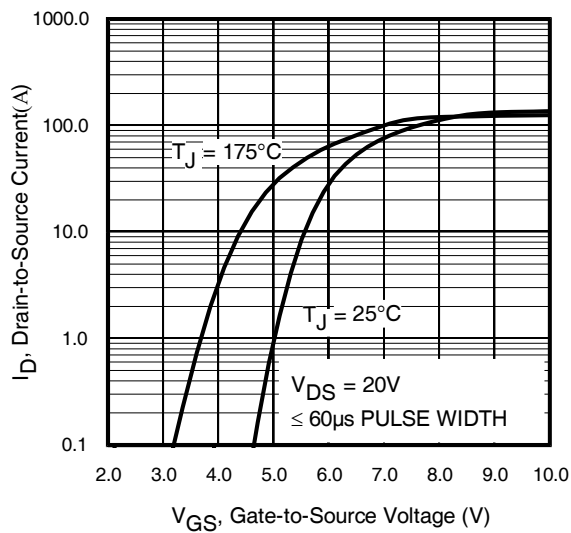
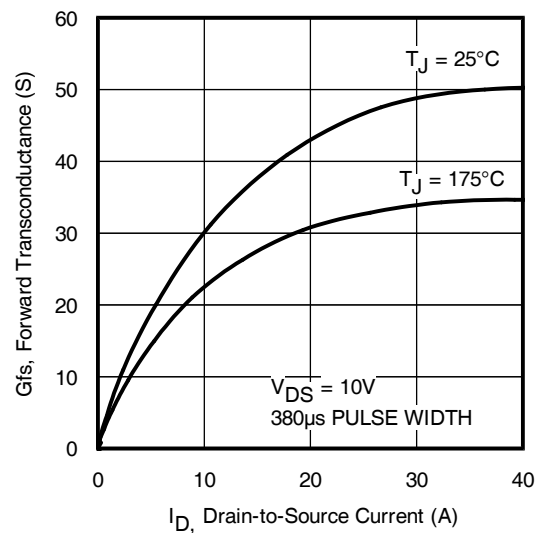
Q <sub>g</sub>	Total Gate Charge	—	34	51	nC	I <sub>D</sub> = 30A
Q <sub>gs</sub>	Gate-to-Source Charge	—	8.9	—		V <sub>DS</sub> = 60V
Q <sub>gd</sub>	Gate-to-Drain Charge	—	14	—		V <sub>GS</sub> = 10V③
t <sub>d(on)</sub>	Turn-On Delay Time	—	14	—	ns	V <sub>DD</sub> = 38V
t <sub>r</sub>	Rise Time	—	59	—		I <sub>D</sub> = 30A
t <sub>d(off)</sub>	Turn-Off Delay Time	—	39	—		R <sub>G</sub> = 15Ω
t <sub>f</sub>	Fall Time	—	28	—		V <sub>GS</sub> = 10V③
L <sub>D</sub>	Internal Drain Inductance	—	4.5	—	nH	Between lead, 6mm (0.25in.) from package and center of die contact
L <sub>S</sub>	Internal Source Inductance	—	7.5	—		
C <sub>iss</sub>	Input Capacitance	—	1440	—	pF	V <sub>GS</sub> = 0V
C <sub>oss</sub>	Output Capacitance	—	190	—		V <sub>DS</sub> = 25V
C <sub>rss</sub>	Reverse Transfer Capacitance	—	110	—		f = 1.0MHz
C <sub>oss</sub>	Output Capacitance	—	720	—		V <sub>GS</sub> = 0V, V <sub>DS</sub> = 1.0V f = 1.0MHz
C <sub>oss</sub>	Output Capacitance	—	130	—		V <sub>GS</sub> = 0V, V <sub>DS</sub> = 60V f = 1.0MHz
C <sub>oss eff.</sub>	Effective Output Capacitance	—	230	—		V <sub>GS</sub> = 0V, V <sub>DS</sub> = 0V to 60V ④

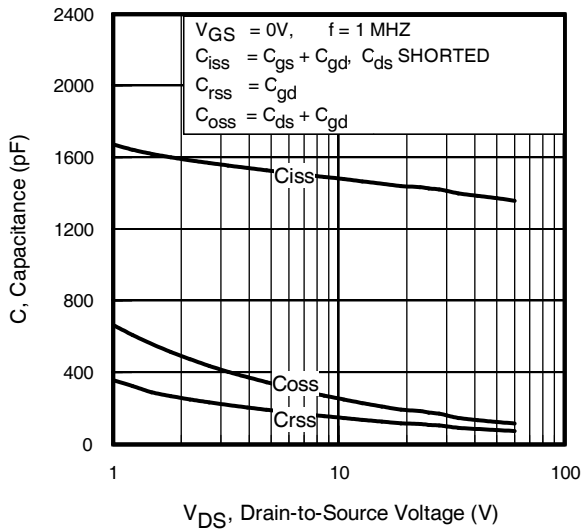
**Diode Characteristics**

	Parameter	Min.	Typ.	Max.	Units	Conditions
I <sub>S</sub>	Continuous Source Current (Body Diode)	—	—	45⑨	A	MOSFET symbol showing the integral reverse p-n junction diode. 
I <sub>SM</sub>	Pulsed Source Current (Body Diode) ①	—	—	180		
V <sub>SD</sub>	Diode Forward Voltage	—	—	1.3	V	T <sub>J</sub> = 25°C, I <sub>S</sub> = 30A, V <sub>GS</sub> = 0V ③
t <sub>rr</sub>	Reverse Recovery Time	—	30	45	ns	T <sub>J</sub> = 25°C, I <sub>F</sub> = 30A, V <sub>DD</sub> = 38V
Q <sub>rr</sub>	Reverse Recovery Charge	—	28	42	nC	di/dt = 100A/μs③
t <sub>on</sub>	Forward Turn-On Time	Intrinsic turn-on time is negligible (turn-on is dominated by L <sub>S</sub> +L <sub>D</sub> )				

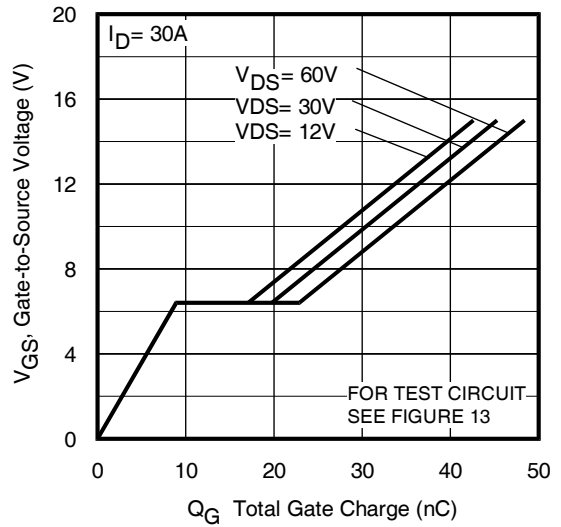
**Notes:**

- ① Repetitive rating; pulse width limited by max. junction temperature. (See fig. 11)
- ② Limited by T<sub>Jmax</sub>, starting T<sub>J</sub> = 25°C, L = 0.21mH, R<sub>G</sub> = 25Ω, I<sub>AS</sub> = 30A, V<sub>GS</sub> = 10V. Part not recommended for use above this value.
- ③ Pulse width ≤ 1.0ms; duty cycle ≤ 2%.
- ④ C<sub>oss eff.</sub> is a fixed capacitance that gives the same charging time as C<sub>oss</sub> while V<sub>DS</sub> is rising from 0 to 80% V<sub>DSS</sub>
- ⑤ Limited by T<sub>Jmax</sub>, see Fig.12a, 12b, 15, 16 for typical repetitive avalanche performance.
- ⑥ This value determined from sample failure population. 100% tested to this value in production.
- ⑦ When mounted on 1" square PCB (FR-4 or G-10 Material). For recommended footprint and soldering techniques refer to application note #AN-994
- ⑧ R<sub>θ</sub> is measured at T<sub>J</sub> approximately 90°C
- ⑨ Calculated continuous current based on maximum allowable junction temperature. Package limitation current is 42A.

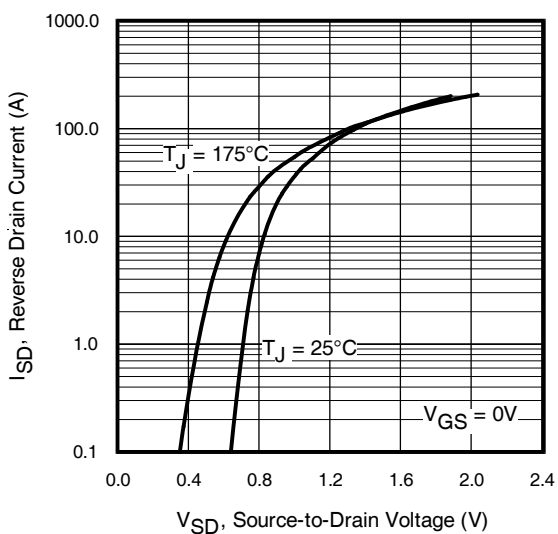

**Fig. 1** Typical Output Characteristics

**Fig. 2** Typical Output Characteristics

**Fig. 3** Typical Transfer Characteristics

**Fig. 4** Typical Forward Transconductance Vs. Drain Current



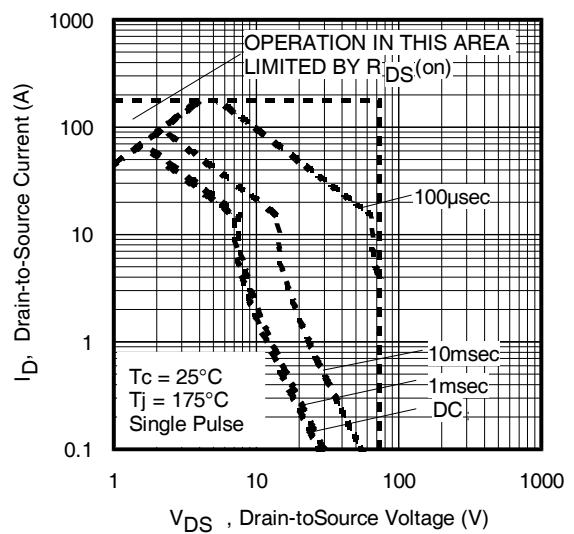
**Fig 5.** Typical Capacitance vs. Drain-to-Source Voltage



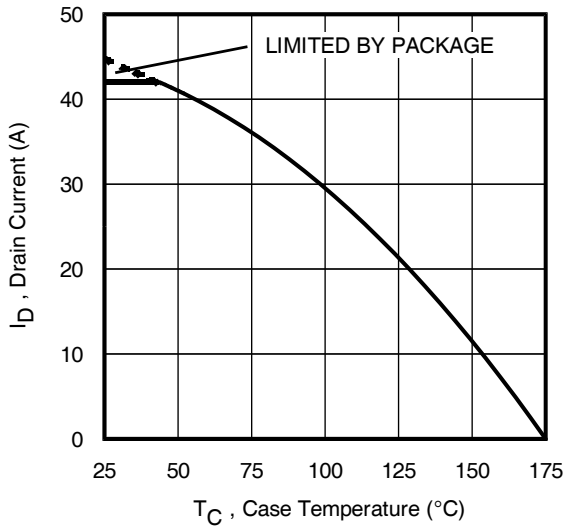
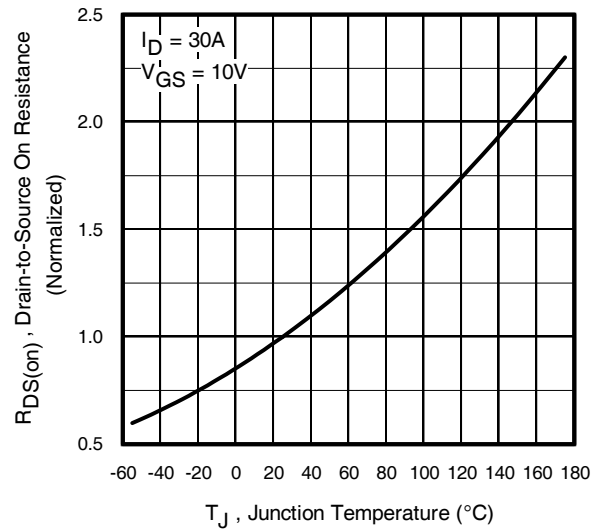
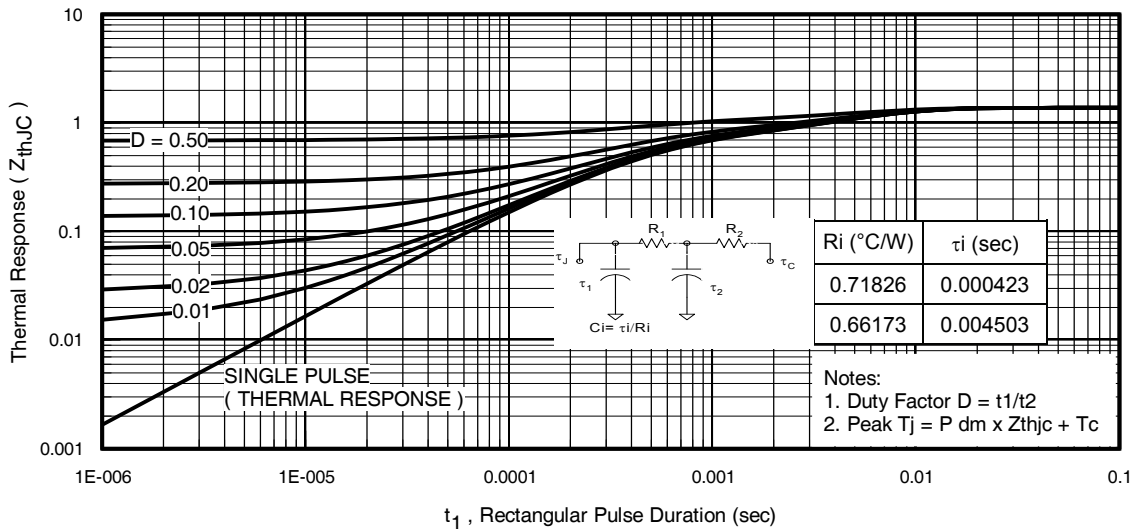
**Fig 6.** Typical Gate Charge vs. Gate-to-Source Voltage

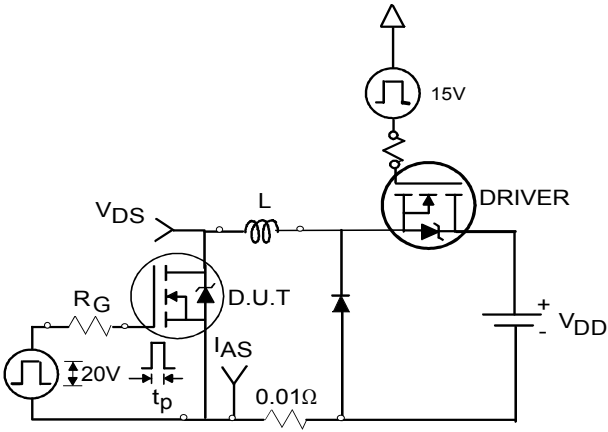
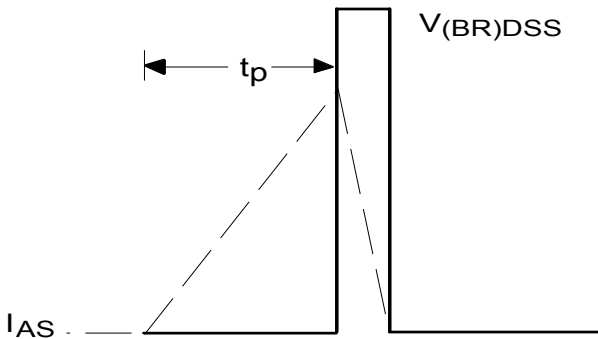
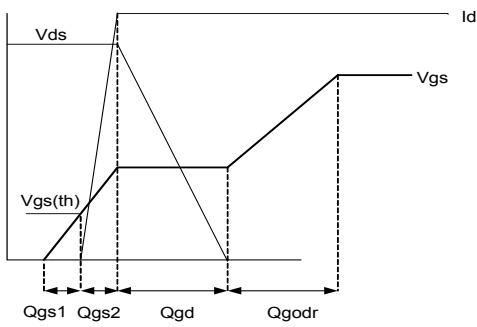


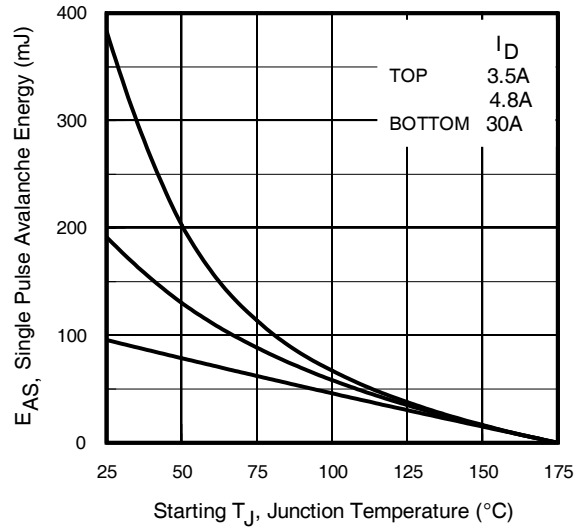
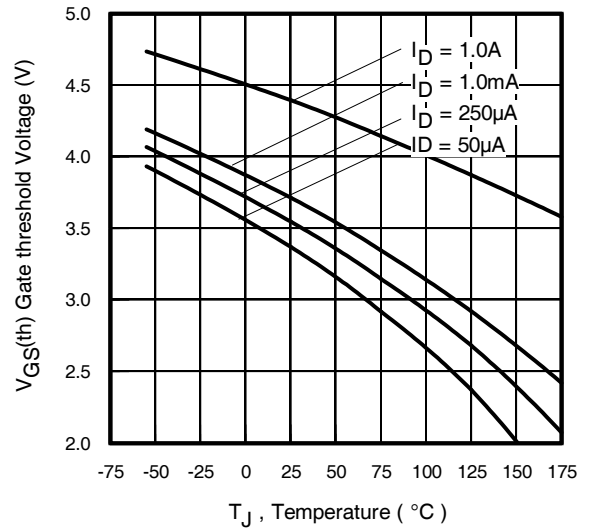
**Fig 7** Typical Source-to-Drain Diode Forward Voltage

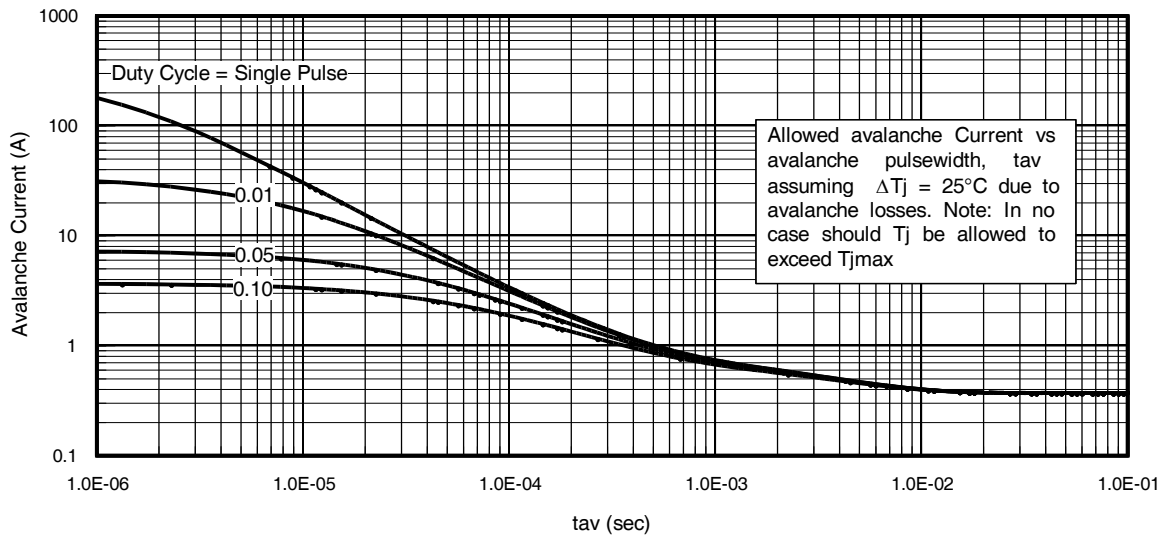
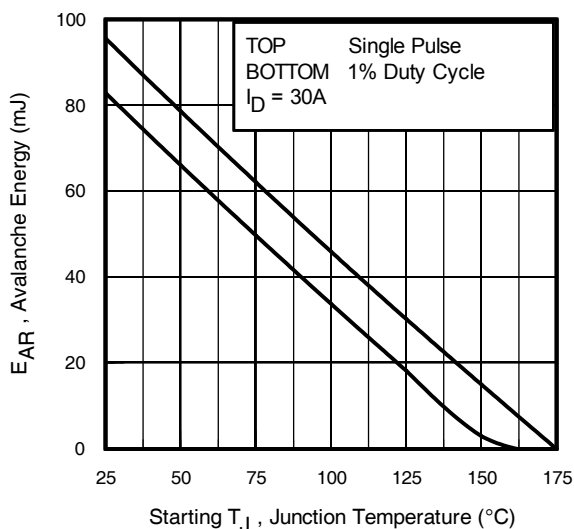


**Fig 8.** Maximum Safe Operating Area


**Fig 9.** Maximum Drain Current Vs. Case Temperature

**Fig 10.** Normalized On-Resistance Vs. Temperature

**Fig 11.** Maximum Effective Transient Thermal Impedance, Junction-to-Case


**Fig 12a. Unclamped Inductive Test Circuit**

**Fig 12b. Unclamped Inductive Waveforms**

**Fig 13a. Gate Charge Waveform**

**Fig 13b. Gate Charge Test Circuit**

**Fig 12c. Maximum Avalanche Energy vs. Drain Current**

**Fig 14. Threshold Voltage Vs. Temperature**


**Fig 15. Typical Avalanche Current Vs.Pulswidth**

**Fig 16. Maximum Avalanche Energy Vs. Temperature**
**Notes on Repetitive Avalanche Curves , Figures 15, 16:**
**(For further info, see AN-1005 at [www.infineon.com](http://www.infineon.com))**

1. Avalanche failures assumption:  
Purely a thermal phenomenon and failure occurs at a temperature far in excess of  $T_{jmax}$ . This is validated for every part type.
2. Safe operation in Avalanche is allowed as long as  $T_{jmax}$  is not exceeded.
3. Equation below based on circuit and waveforms shown in Figures 12a, 12b.
4.  $P_{D(ave)}$  = Average power dissipation per single avalanche pulse.
5.  $BV$  = Rated breakdown voltage (1.3 factor accounts for voltage increase during avalanche).
6.  $I_{av}$  = Allowable avalanche current.
7.  $\Delta T$  = Allowable rise in junction temperature, not to exceed  $T_{jmax}$  (assumed as 25°C in Figure 15, 16).  
 $t_{av}$  = Average time in avalanche.  
 $D$  = Duty cycle in avalanche =  $t_{av} \cdot f$   
 $Z_{thJC}(D, t_{av})$  = Transient thermal resistance, see Figures 13)

$$P_{D(ave)} = 1/2 ( 1.3 \cdot BV \cdot I_{av} ) = \Delta T / Z_{thJC}$$

$$I_{av} = 2\Delta T / [1.3 \cdot BV \cdot Z_{th}]$$

$$E_{AS(AR)} = P_{D(ave)} \cdot t_{av}$$



**Fig 17.** Peak Diode Recovery  $dv/dt$  Test Circuit for N-Channel HEXFET® Power MOSFETs



**Fig 18a.** Switching Time Test Circuit



**Fig 18b.** Switching Time Waveforms



## D-Pak (TO-252AA) Package Outline (Dimensions are shown in millimeters (inches))



**NOTES:**

- 1.- DIMENSIONING AND TOLERANCING PER ASME Y14.5M-1994
- 2.- DIMENSION ARE SHOWN IN INCHES [MILLIMETERS]
- 3.- LEAD DIMENSION UNCONTROLLED IN L5.
- 4.- DIMENSION D1, E1, L3 & b3 ESTABLISH A MINIMUM MOUNTING SURFACE FOR THERMAL PAD.
- 5.- SECTION C-C DIMENSIONS APPLY TO THE FLAT SECTION OF THE LEAD BETWEEN .005 AND 0.10 [0.13 AND 0.25] FROM THE LEAD TIP.
- 6.- DIMENSION D & E DO NOT INCLUDE MOLD FLASH. MOLD FLASH SHALL NOT EXCEED .005 [0.13] PER SIDE. THESE DIMENSIONS ARE MEASURED AT THE OUTMOST EXTREMES OF THE PLASTIC BODY.
- 7.- DIMENSION b1 & c1 APPLIED TO BASE METAL ONLY.
- 8.- DATUM A & B TO BE DETERMINED AT DATUM PLANE H.
- 9.- OUTLINE CONFORMS TO JEDEC OUTLINE TO-252AA.

SYMBOL	DIMENSIONS				NOTES
	MILLIMETERS		INCHES		
	MIN.	MAX.	MIN.	MAX.	
A	2.18	2.39	.086	.094	
A1	-	0.13	-	.005	
b	0.64	0.89	.025	.035	
b1	0.65	0.79	.025	.031	7
b2	0.76	1.14	.030	.045	
b3	4.95	5.46	.195	.215	4
c	0.46	0.61	.018	.024	
c1	0.41	0.56	.016	.022	7
c2	0.46	0.89	.018	.035	
D	5.97	6.22	.235	.245	6
D1	5.21	-	.205	-	4
E	6.35	6.73	.250	.265	6
E1	4.32	-	.170	-	4
e	2.29 BSC		.090 BSC		
H	9.40	10.41	.370	.410	
L	1.40	1.78	.055	.070	
L1	2.74 BSC		.108 REF.		
L2	0.51 BSC		.020 BSC		
L3	0.89	1.27	.035	.050	4
L4	-	1.02	-	.040	
L5	1.14	1.52	.045	.060	3
φ	0"	10"	0"	10"	
φ1	0"	15"	0"	15"	
φ2	25"	35"	25"	35"	

LEAD ASSIGNMENTS

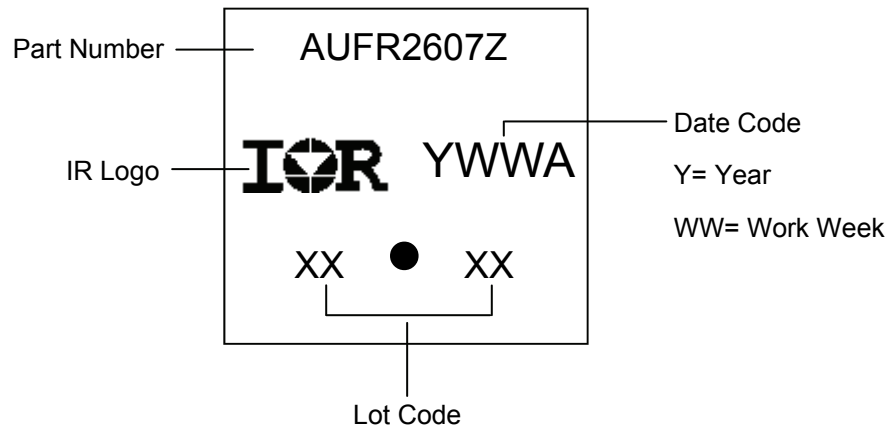
HEXFET

- 1.- GATE
- 2.- DRAIN
- 3.- SOURCE
- 4.- DRAIN

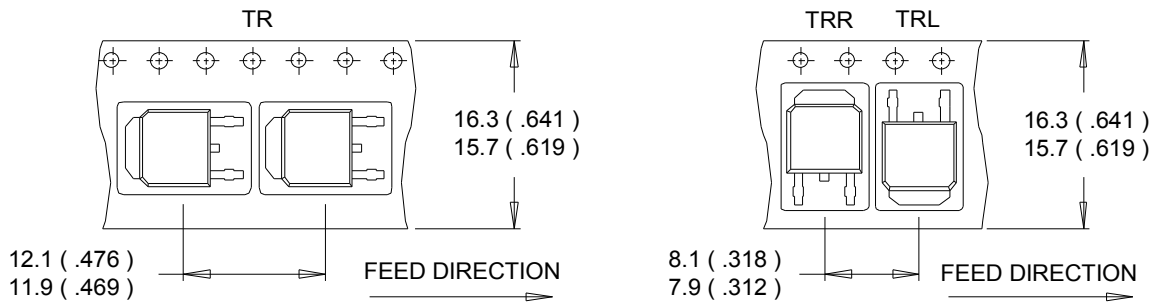
IGBT & CoPAK

- 1.- GATE
- 2.- COLLECTOR
- 3.- EMITTER
- 4.- COLLECTOR

## D-Pak (TO-252AA) Part Marking Information



Note: For the most current drawing please refer to IR website at <http://www.irf.com/package/>

**D-Pak (TO-252AA) Tape & Reel Information (Dimensions are shown in millimeters (inches))**

**NOTES :**

1. CONTROLLING DIMENSION : MILLIMETER.
2. ALL DIMENSIONS ARE SHOWN IN MILLIMETERS ( INCHES ).
3. OUTLINE CONFORMS TO EIA-481 & EIA-541.


**NOTES :**

1. OUTLINE CONFORMS TO EIA-481.

Note: For the most current drawing please refer to IR website at <http://www.irf.com/package/>

**Qualification Information**

<b>Qualification Level</b>		Automotive (per AEC-Q101)	
		Comments: This part number(s) passed Automotive qualification. Infineon's Industrial and Consumer qualification level is granted by extension of the higher Automotive level.	
<b>Moisture Sensitivity Level</b>		D-Pak	MSL1
<b>ESD</b>	Machine Model	Class M4 (+/- 425V) <sup>†</sup> AEC-Q101-002	
	Human Body Model	Class H1B (+/- 1000V) <sup>†</sup> AEC-Q101-001	
	Charged Device Model	Class C5 (+/- 1125V) <sup>†</sup> AEC-Q101-005	
<b>RoHS Compliant</b>		Yes	

† Highest passing voltage.

**Revision History**

Date	Comments
10/12/2015	<ul style="list-style-type: none"> <li>Updated datasheet with corporate template</li> <li>Corrected ordering table on page 1.</li> </ul>

**Published by**  
**Infineon Technologies AG**  
**81726 München, Germany**  
 © Infineon Technologies AG 2015  
**All Rights Reserved.**

**IMPORTANT NOTICE**

The information given in this document shall in no event be regarded as a guarantee of conditions or characteristics ("Beschaffungsgarantie"). With respect to any examples, hints or any typical values stated herein and/or any information regarding the application of the product, Infineon Technologies hereby disclaims any and all warranties and liabilities of any kind, including without limitation warranties of non-infringement of intellectual property rights of any third party.

In addition, any information given in this document is subject to customer's compliance with its obligations stated in this document and any applicable legal requirements, norms and standards concerning customer's products and any use of the product of Infineon Technologies in customer's applications.

The data contained in this document is exclusively intended for technically trained staff. It is the responsibility of customer's technical departments to evaluate the suitability of the product for the intended application and the completeness of the product information given in this document with respect to such application.

For further information on the product, technology, delivery terms and conditions and prices please contact your nearest Infineon Technologies office ([www.infineon.com](http://www.infineon.com)).

**WARNINGS**

Due to technical requirements products may contain dangerous substances. For information on the types in question please contact your nearest Infineon Technologies office.

Except as otherwise explicitly approved by Infineon Technologies in a written document signed by authorized representatives of Infineon Technologies, Infineon Technologies' products may not be used in any applications where a failure of the product or any consequences of the use thereof can reasonably be expected to result in personal injury.