



JVC

ENGLISH
DEUTSCH
FRANÇAIS
NEDERLANDS
CASTELLANO
ITALIANO



InteríArt **T-V LINK**

AV-29FH1SUG
AV-29FH1BUG

COLOUR TELEVISION

INSTRUCTIONS

FARBFERNSEHGERÄT
TELEVISEUR COULEUR
KLEURENTELEVISIE
TELEVISOR A COLOR
TELEVISORE A COLORI
TELEVISOR A CORES

BEDIENUNGSANLEITUNG
MANUEL D'INSTRUCTIONS
GEBRUIKSAANWIJZING
MANUAL DE INSTRUCCIONES
ISTRUZIONI
INSTRUÇÕES

Thank you for buying this JVC colour television.
To make sure you understand how to use your new TV, please read this manual thoroughly before you begin.

IMPORTANT SAFEGUARDS

1. WATER AND MOISTURE

The apparatus shall not be exposed to dripping or splashing water and no object filled with liquids, such as vases, should be placed on the apparatus.

2. HEAT

Never place the set near heat sources.
Never put a naked flame, such as a candle, on the top of TV set.

3. VENTILATION

Do not cover the ventilation openings in the cabinet and never place the set in a confined space such as in a bookcase or built-in cabinet unless proper ventilation is provided. Leave a minimum 10 cm gap all around the unit.

4. OBJECT ENTRY

Do not insert foreign objects, such as needles and coins, in the ventilation openings.

5. LIGHTNING STRIKE

You should disconnect the set from the mains and the aerial system during thunderstorms.

6. CLEANING

Unplug the set from the mains while cleaning.

7. AFTER MOVING THE SET

If the set is moved or turned, the MAIN POWER button must be switched off for at least 15 minutes in order to take out colour patches on the screen.

8. CAUTION

There is danger of choking or suffocation if the cap which is removed from the TV is accidentally swallowed by children. Store the cap out of the reach of children.

CONTENTS

IMPORTANT SAFEGUARDS	1
IDENTITY OF LOCAL & REMOTE CONTROL	2
SETTING UP	3
START UP	3
INSTALLATION	4
TV-LINK FUNCTION	7
DAILY USE	8
TELETEXT	12
CONNECTING EXTERNAL EQUIPMENT	14
TROUBLESHOOTING	15
SPECIFICATIONS	16

IDENTITY OF LOCAL & REMOTE CONTROL

LOCAL CONTROL

Front

- | | | | |
|----|----------------------------------|-----|-------------------------|
| B1 | MAIN POWER button | B6 | STAND-BY indicator |
| B2 | FRONT S-VIDEO INPUT socket Ext-3 | B7 | REMOTE sensor |
| B3 | FRONT VIDEO INPUT socket Ext-3 | B8 | TV / AV button |
| B4 | FRONT AUDIO INPUT socket Ext-3 | B9 | VOLUME UP/DOWN buttons |
| B5 | HEADPHONE socket | B10 | PROGRAM UP/DOWN buttons |

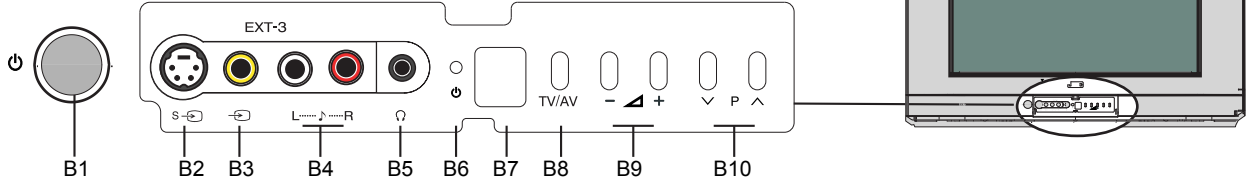

Rear

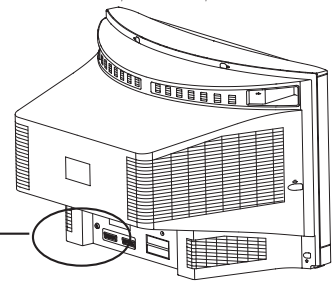
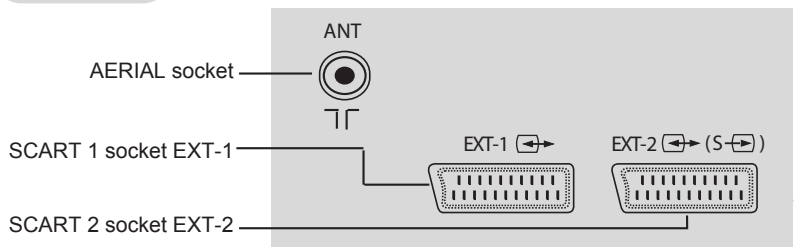

ENGLISH

REMOTE CONTROL

TV mode

- | | | |
|-----|--|-----------------------------|
| A1 | | SOUND MUTE |
| A2 | | POWER |
| A3 | | NUMBER 0..9 |
| A4 | | ZOOM / SKIP |
| A5 | | SOUND EFFECT / MOVE |
| A6 | | SLEEP / DELETE |
| A7 | | Not used |
| A8 | | TV > TELETEXT |
| A9 | | PICTURE / OK |
| A10 | | MENU |
| A11 | | PROGRAM UP (CURSOR UP) |
| A12 | | PROGRAM DOWN (CURSOR DOWN) |
| A13 | | VOLUME DOWN (CURSOR LEFT) |
| A14 | | VOLUME UP (CURSOR RIGHT) |
| A15 | | TV / AV |
| A16 | | Not used |
| A17 | | Not used |
| A18 | | Not used |
| A19 | | Not used |
| A20 | | Not used |
| A21 | | Not used |
| A22 | | Not used |
| A23 | | Not used |
| A24 | | INFORMATION |
| A25 | | VCR / TELETEXT / DVD switch |
| A26 | | MODE Stereo/Mono |

RM-C1514

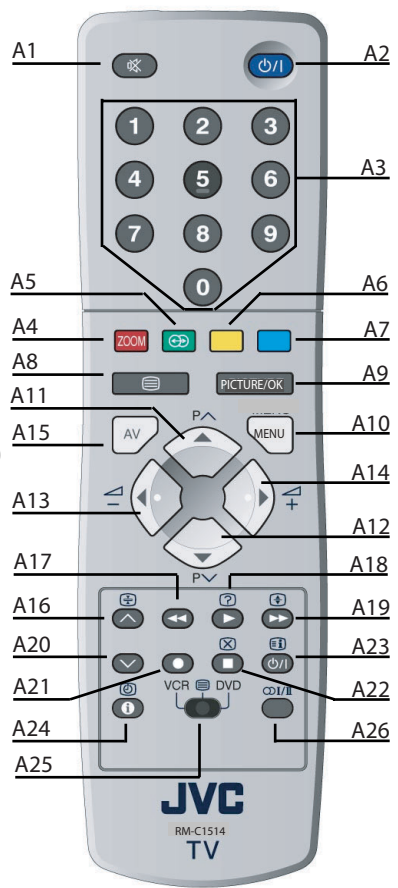

TELETEXT mode

- | | | |
|-----|--|--|
| A1 | | SOUND MUTE |
| A2 | | POWER |
| A3 | | NUMBER 0..9 |
| A4 | | RED |
| A5 | | GREEN |
| A6 | | YELLOW |
| A7 | | CYAN |
| A8 | | TELETEXT > TV |
| A9 | | Not used |
| A10 | | VOL/BRIGHTNESS/CONTRAST MENU SELECTION |
| A11 | | PAGE UP |
| A12 | | PAGE DOWN |
| A13 | | VOL/BRIGHTNESS/CONTRAST DOWN |
| A14 | | VOL/BRIGHTNESS/CONTRAST UP |
| A15 | | Not used |
| A16 | | PAGE HOLD |
| A17 | | Not used |
| A18 | | REVEAL |
| A19 | | DOUBLE SIZE |
| A20 | | Not used |
| A21 | | Not used |
| A22 | | CANCEL |
| A23 | | INDEX |
| A24 | | SUBPAGE |
| A25 | | VCR / TELETEXT / DVD switch |
| A26 | | Not used |



SETTING UP

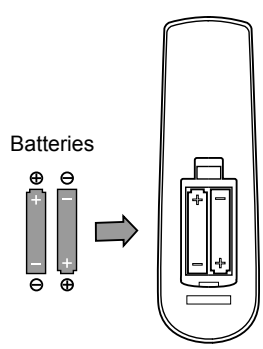

Batteries
 Open remote control battery compartment (at the rear) and insert two 1.5V type AA / R6 batteries.
 Warning: be careful to respect battery polarities.

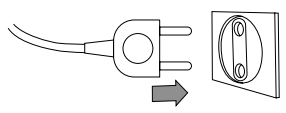

Insert the main plug into a 220 - 240V 50Hz AC power socket.

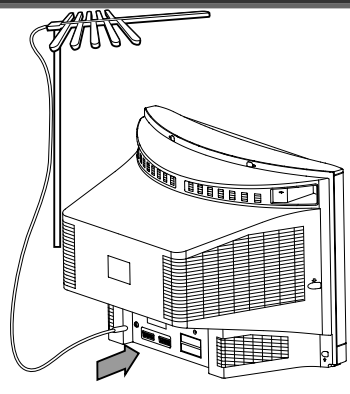

Connect aerial to aerial jack. It is usually connected by means of a 75 ohm cable.

START UP

SWITCHING ON

Switch the TV set on with the **MAIN POWER** button (B1).

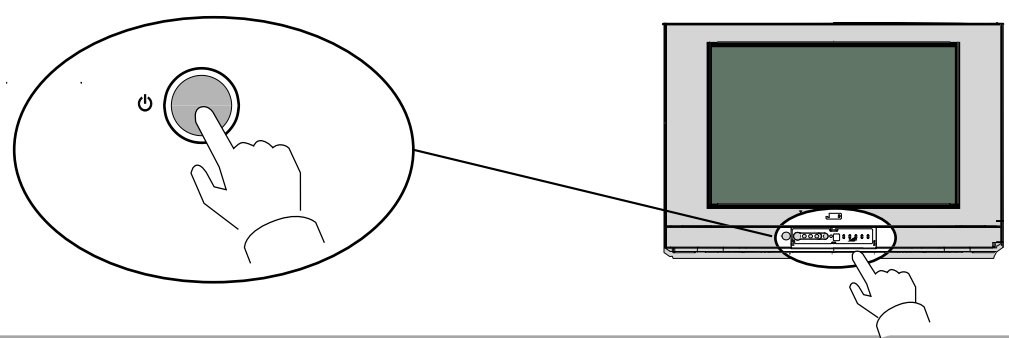

LANGUAGE MENU

The very first time that you turn on the TV, the **LANGUAGE** menu will appear on the screen. Its purpose is to enable you to select the language that will be used for all the OSD (On Screen Display) menus. The user must enter a choice of language before proceeding further. The descriptions used in the menu are those of the country code (e.g. GB = English, NL = Holland etc).

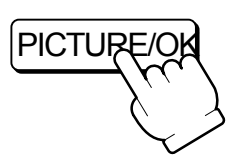
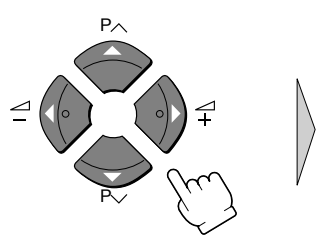

LANGUAGE				
BG	CZ	D	DK	E
F	FIN	GB	GR	H
I	N	NL	PL	RO
RUS	S			

Selection is made by use of the remote control **CURSOR UP** (A11) / **CURSOR DOWN** (A12) buttons and **CURSOR LEFT** (A13) / **RIGHT** (A14) buttons. Once you are satisfied with your selection, push the **OK** button (A9) to confirm your choice, and then the menu will disappear.

The language entered at this stage can still be modified at any later time, by entering the **LANGUAGE** selection (accessed from the **FEATURES** menu page 11).

Note : The languages shown are subject to modification without prior notice.

INSTALLATION

AUTO TUNING SYSTEM

MENU SELECTION

Press remote control **MENU** button (A10) to display the **MAIN MENU**.

Move the cursor to **INSTALL** by using the remote control **CURSOR UP** (A11), **DOWN** (A12) buttons.

Then press the remote control **OK** button (A9).

Note: All menus are removed within 60 seconds if you don't press any button.

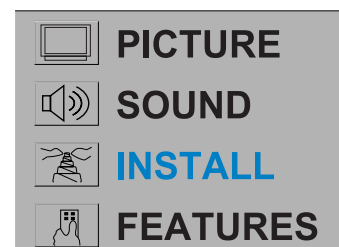

COUNTRY SELECTION

Position the cursor at **ATSS** Menu and select country code where TV is used by pressing the remote control **CURSOR LEFT** (A13), **RIGHT** (A14) buttons.

The following countries can be selected.

A, B, CH, CZ, D, DK
E, F, FIN, GB, H, I, IRL,
N, NL, P, PL, S, SK, Others

INSTALL	
ATSS	GB
EDIT	
SYSTEM	GB
CHANNEL	C 31
FREQUENCY	551.25
NAME	BBC1
PROGRAM	01
STORE TO	01

ATSS - Auto Tuning and Sorting System

After selecting country code, press and hold **OK** button for 3 - 4 seconds until "**Please wait!**" is displayed, then auto program tuning starts searching all the available TV stations in your area. When auto tuning and sorting is completed, the **EDIT** menu with the recorded programs appears on the screen.

You can proceed to edit the the program numbers using the **EDIT** functions. For details, see "EDIT MENU" below.

If you do not need to use the **EDIT** functions, go to next step to download the data to VCR with the **T-V LINK** function.

To exit the **EDIT** menu, press **MENU** button 3 times, then the menu display will disappear from TV screen. Now you can select program using the remote control **UP** (A11) or **DOWN** (A12) buttons.

EDIT MENU

The **EDIT** menu shows you the programme position assignment. When using the **AUTO TUNING** method, the broadcasts may not be found and stored in the order you desired. For example, BBC1 may not be allocated to programme number 01, and BBC2 may not be allocated to programme number 02, etc. The **EDIT** menu enables you to change the programme position assignment according to your personal preference.

To reach the **EDIT** menu you have to first select **INSTALL** menu from the **MAIN** menu.

EDIT			
PR	NAME	CH	SKIP
06	CH 5	C46	
05	S4C	C39	
04	CH 4	C05	
03	ITV	C31	
02	BBC2	C34	
01	BBC1	C37	
00	-----	C21	✓

CHANGING ORDER OF CHANNELS

Position the cursor to the programme number you want to move and press the remote control **GREEN** (A5) **MOVE** button. The programme turns to red colour. Then use the **UP** (A11) or **DOWN** (A12) buttons to move the programme number you wish to store it to and press **MOVE** button again to confirm the operation. Press **MENU** to return to **INSTALL** menu.

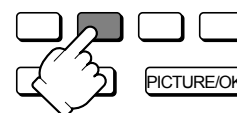

DELETE PROGRAMME POSITION DATA

Position the cursor to the programme number you wish to delete using the remote control **UP** (A11) or **DOWN** (A12) buttons. Press the **YELLOW/DELETE** (A6) button.

The delete programme is instantly moved to programme N° 99. The programme which was located at N° 99 will automatically move to N° 98.



SKIPPING THE CHANNELS

Position the cursor to the programme number you wish to skip, then press the **RED** (SKIP) (A4) button. A skipped programme is marked with the sign "✓" at its right end. The channel corresponding to a skipped programme will not appear on screen when changing channels using **PROGRAM UP** (A11) / **DOWN** (A12) buttons.

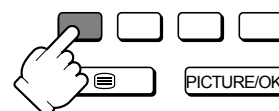

USING THE DECODER (EXT -2) FUNCTION WITH T-V LINK:

When connecting a T-V LINK compatible VCR to the EXT-2 terminal, be sure to connect the Decoder to the VCR. If not the T-V LINK function may not work properly.

Position the cursor to the channel capable of being unscrambled with the decoder on EXT-2, then press the **"CYAN"** (A7) button. A channel functioning with a decoder is marked with the icon of a key beside the program number.

Even if the decoder is functioning a scrambled picture appears at this time. The decoded signal won't be visible until you exit **EDIT** and **INSTALL** menus.

DOWNLOADING THE DATA TO VCR WITH T-V LINK

In the **EDIT** menu, you can transmit the latest Program number data to the VCR with the **T-V LINK** function. To start the data transfer, you must press and hold OK button for 3-4 seconds until **"TV → VCR"** is displayed flashing in the header of **EDIT** menu.

Caution : This operation will only be successful if a T-V LINK compatible VCR is connected to the EXT-2 terminal, and if the VCR is ON.

Once the data transmission ends, the **"TV → VCR"** indicator disappear and the EDIT menu vanishes after 3 sec.

Note : If the TV is unable to transfer the data, the feature not available is displayed in the header of EDIT menu in red to indicate an error. In such case, ensure the following three items are correct.

- Has the T-V LINK compatible VCR been connected to the EXT-2 terminal?
- Has the VCR power been turned ON?
- Does the SCART cable that is connected to the EXT-2 terminal to T-V LINK compatible VCR have all proper connections?

If above is OK, then press and hold 3-4 seconds again.

MANUAL CHANNEL TUNING

Tuning by **ATSS** (Auto Tuning Sorting System) is recommendable, as it is the easiest tuning method. But Manual Tuning is also possible using the following procedure.

BROADCASTING SYSTEM SELECTION

Select **INSTALL** menu and using the remote control **CURSOR UP** (A11) / **DOWN** (A12) buttons, move the cursor to **SYSTEM** menu and select the appropriate system by the **LEFT** (A13) or **RIGHT** (A14) button.

"FRANCE"	France SECAM L/L'
"GB"	Great Britain / Ireland PAL-I/I'
"EURO"	Westen Europe PAL-SECAM B/G
"E/EURO"	Eastern Europe PAL-SECAM D/K

INSTALL	
ATSS	GB
EDIT	GB
SYSTEM	GB
CHANNEL	C 49
FREQUENCY	551.25
NAME	BBC1
PROGRAM	01
STORE TO	01

ACTIVATING MANUAL TUNING

Move the cursor to **FREQUENCY** (channel frequency) menu and press and hold for more than 2 seconds the remote control **CURSOR LEFT** (A13) or **RIGHT** (A14) buttons. When one channel is tuned, the corresponding station name is indicated automatically in **NAME** menu.

To tune the next channel, press the remote control **CURSOR LEFT** (A13) or **RIGHT** (A14) buttons again.

CHANNEL AND FREQUENCY MENU

If you know the channel or frequency number you want to search, enter the data by 0...9 buttons. TV will tune that channel quickly.

PERFORM FINE TUNING

If you are unable to obtain good picture or reasonable sound volume due to poor reception it is possible to perform fine tuning.

- Select the "**FREQUENCY**" menu.
- Press for less than 2 seconds, the remote control **CURSOR LEFT** (A13) and **CURSOR RIGHT** (A14) buttons to activate **FINE TUNING** in steps of 0.05 MHz(50kHz).

STORING CHANNEL NAME

When one channel is tuned, the corresponding station NAME will be detected automatically. But in some cases, NAME will not be detected due to the broadcasting situation. You may put in the channel NAME yourself.

Position the cursor to **NAME** menu and press the remote control **CURSOR RIGHT**(A14) button. A cursor appears on the left end of NAME line ("-----"). Then press **CURSOR UP** (A11) or **DOWN** (A12) buttons until you get the right letter or symbol. Move the cursor to the next position by using **CURSOR LEFT** (A13) or **RIGHT** (A14) buttons and repeat the operation. Press **OK** (A9) button to store the NAME.

PROGRAM MENU

The number on the right side of the **PROGRAM** menu indicates the program number of the currently displayed channel.

STORE TO MENU

Select **STORE TO** menu and select the program number by 0...9 buttons or **CURSOR LEFT** (A13) or **RIGHT** (A14) buttons to which you want to store the currently displayed channel then press **OK** button.

Warning ! If you store the number already programmed, the previous programmes will be erased automatically.

CAUTION TO T-V LINK COMPATIBLE VCR USER :

After any channel arrangement modification you must also update the data memorised in your VCR. This can be done easily with the T-V LINK. See page 5 : DOWNLOADING THE DATA TO VCR.

T-V LINK FUNCTIONS

When a T-V LINK compatible VCR is connected to the EXT-2 Terminal on the TV, it is easier to set up the VCR and to view videos. T-V LINK uses the following features:

TO USE T-V LINK FUNCTIONS:

A T-V LINK compatible VCR is necessary.

The VCR must be connected to the EXT-2 terminal on the TV by a fully wired SCART cable.

Note: A "T-V LINK compatible VCR means a JVC VCR with the T-V LINK logo or a VCR with one of the following logos. However, these VCRs may support some or all of the features described below. For details, refer to your VCR instruction manual.

"Q-LINK" (a trademark of Panasonic Corporation)

"Data Logic" (a trademark of Metz Corporation)

"Easy Link" (a trademark of Philips Corporation)

"Megalogic" (a trademark of Grundig Corporation)

"SMARTLINK" (a trademark of Sony Corporation)

PRE-SET DOWNLOAD

Download the registered data on the TV channels from the TV to the VCR.

The Preset Download function must be used when the initial setting is complete or whenever the AUTO PROGRAM or EDIT/MANUAL operations are performed.

Note: This function can be operated via VCR operation.

When "TV → VCR" is displayed in red :

If "TV → VCR" is displayed in red, the download was not performed correctly. Before trying to download again, ensure the following :

- The VCR power is turned on.
- The VCR is T-V LINK compatible
- The VCR is connected to the EXT-2 terminal
- The SCART cable is fully wired.

If all points are OK, please press and hold OK button 3-4 seconds.

DIRECT REC.

"What You See is What You Record"

You can record to VCR the images that you are currently viewing on TV by a simple operation.

For details, read the manual for your VCR.

The recording is initiated by the VCR.

Caution: When recording images from an external device connected to the TV, the VCR will stop recording if the TV is turned off or if the input is switched.

The direct recording is not possible under following condition :

- When INSTALL or EDIT menu are on screen.
- When watching teletext

Note: - Operation via the TV is not possible

- Generally, the VCR cannot record a TV channel that cannot be received properly by the VCR's tuner, even though you can view that TV channel on the TV. However, some VCR's can record a TV channel by using the TV's output if that channel can be viewed on the TV, even though the TV channel cannot be received properly by the VCR's tuner. For details, refer to your VCR instruction manual.
- When the signal source is RGB, direct recording function may not operate properly. To check if the TV signal source is RGB, press 'i' key, the program status display will indicate "EXT-1 RGB".

TV AUTO POWER ON/VCR IMAGE VIEW

When the VCR starts playing, the TV automatically turns on and the images from EXT-2 terminal are displayed on the screen.

When the VCR menu is operated, the TV automatically turns on and the image from EXT-2 terminal are displayed on the screen.

Note: This function does not operate if your TV's main power is turned off. Set your TV's main power to on (standby mode).

DAILY USE

SWITCHING ON AND OFF TV SET

SWITCHING ON

If stand-by indicator (B6) is not lit, then the TV set is powered off.

Switch the set ON with **POWER (ON/OFF)** Button  (B1), then, stand-by indicator turns to red.

Press again **PROGRAM UP** or **DOWN** buttons (B10) on the front of the set, or **POWER** button (A2) or **UP/DOWN** button (A11) or, one of the NUMBER 0...9 button on the remote control, then stand-by indicator turn to green and picture appears on the screen.

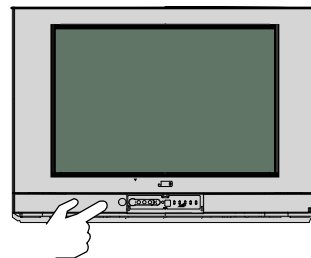

If **stand-by indicator** (B6) is flashing red and green, TV set is in **CHILD LOCK** mode. To deblock CHILD LOCK, press the remote control **POWER** button (A2) or one of NUMBER 0...9 buttons (A3) or **PROGRAM UP** (A11) / **DOWN** (A12) buttons.

Note : The front panel **PROGRAM UP** or **DOWN** (B10) button will not function when CHILD LOCK is ON.



SWITCHING OFF

Press **POWER** button (A2) on the remote control to return the set to its **STAND BY** mode. If you don't use the set for an extended period of time, turn it off with **MAIN POWER** button (B1) on the set.

PROGRAM SELECTION (FROM 0 TO 99)

11	-----
10	-----
09	-----
08	-----
07	-----
06	CHANNEL 5
05	S4C
04	CHANNEL 4
03	ITV
02	BBC2
01	BBC1
00	-----
99	-----
98	-----
97	-----
96	-----
95	-----
94	-----
93	-----
92	-----
91	-----

Direct selection

Use the remote control NUMBER 0..9 buttons (A3). For two digit program numbers, enter the second digit within 2 seconds.



Up / Down selection

Use the remote control **PROGRAM UP** (A11) / **DOWN** (A12) buttons or the TV set front panel **PROGRAM UP** / **DOWN** buttons (B10).

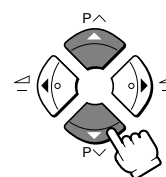

LIST menu

Press on the **CYAN** button (A7) to display the **LIST** menu. Then use the **CURSOR UP** (A11) or **DOWN** (A12) buttons to browse the list and find a program, with the aid of the program numbers plus associated names (see section Manual Channel Tuning pages 5/6 for how to add or modify program names).

When you have found a program you want to select (the highlighted line in the middle of the menu), press on the **OK** button (A9) to tune this program. The **LIST** menu will disappear at the same time.

If you decide to keep the current program, the menu can be cancelled at any time by pressing on the **CYAN** button (A7).

SOUND CONTROL

Volume adjustment

Use the remote control **VOLUME UP** (A14) / **DOWN** (A13) buttons or the TV set front panel **VOLUME UP / DOWN** buttons (B9).

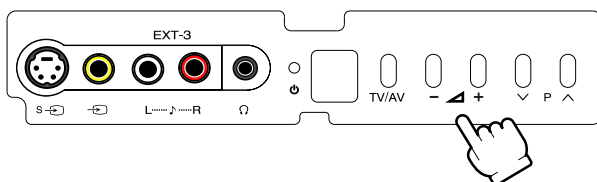
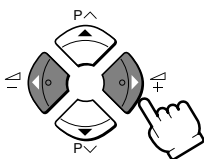

Mono forcing, dual language



- If you are unable to get good sound quality for a program due to poor reception, you can force a change from stereo to mono transmission by pressing the remote control **MODE** button (A26). Then the program status display will indicate "**MONO**" with a (I/I) icon.



- On the other hand, during a program with dual language transmission, the **MODE** button (A26) allows you to toggle between the first and second language. The program status display will indicate "DUAL 1" or "DUAL 2" (plus NICAM according to the received signal) instead of Stereo or Mono.

- To return to initial state, press again the **MODE** button (A26).

Mute

- Mute the sound by pressing the remote control **SOUND MUTE** button (A1).
- Then,  logo is displayed. The previous sound setting is returned after pressing the same button a second time.
- If a sound related function is used (e.g. VOLUME, ) then the **MUTE** will also be cancelled.



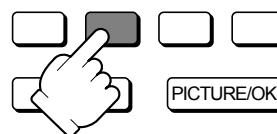

Sound effects

A **SPATIAL** sound effect is available, by using the remote control  (A5) button.

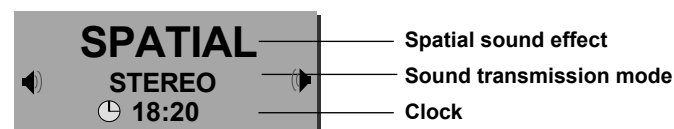

The following display appears:



To return to initial sound effect, press again the  (A5) button.

The following display appears:

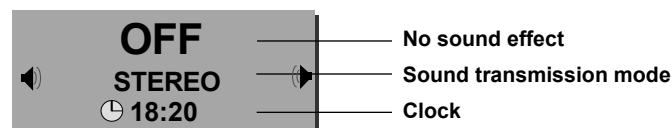

For other adjustments such as **BALANCE**, **BASS** or **TREBLE** use the **SOUND** menu (here under).

SOUND MENU

Select **SOUND** menu from the **MAIN** menu.

- Select **VOLUME** function to adjust the volume level.
- Select **BALANCE** function to adjust sound balance between the left and right speakers. If the indicator is highlighted in red, then the central balance position has been found.
- Select the **BASS** and **TREBLE** functions to adjust the tone levels.

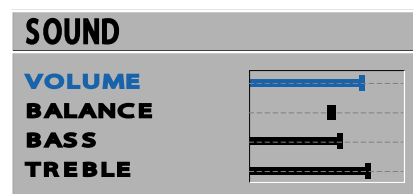

PICTURE CONTROL

Select **PICTURE** menu from the **MAIN** menu.

- Select and adjust the level of each function: **BRIGHTNESS**, **CONTRAST**, **COLOUR**, **SHARPNESS**, **TINT** (if available) and **NOISE REDUCTION**.
- The above modified values are automatically stored in **FAVOURITE** mode.
- **NOISE REDUCTION** feature has 4 levels according to your preference.
- The **FAVOURITE** preset contains the settings that you lastly entered.

If the NTSC standard is detected (eg from VHS player connected to EXT-1), then **TINT** will be available. Otherwise, **TINT** will be displayed but not selectable.

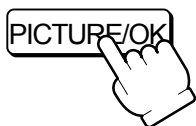
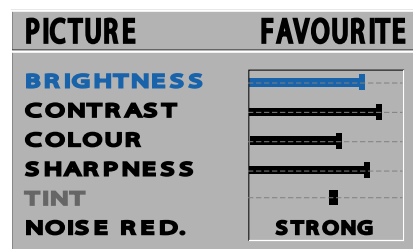

You can select three pictures settings, by pressing repeatedly the remote control **PICTURE/OK** button (A9) :

- **NORMAL I** (standard hard picture)
- **NORMAL II** (standard soft picture)
- **FAVORITE**.

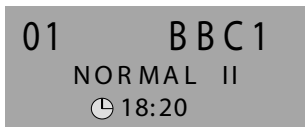
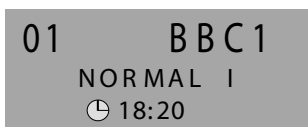

PROGRAM STATUS DISPLAY (INFORMATION)

Use the remote control **i** button (A24) to display (for 4 seconds only) program status information. This display appears also after a program selection or after switching on the TV set.

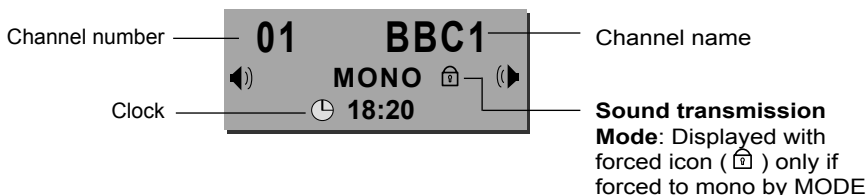

SLEEP FUNCTION

The set will turn off (to stand-by mode) after a period of time that you can select. By pressing repeatedly the remote control **YELLOW** button (A6), you can enter one of the following settings :

OFF > 20 min > 40 min > 60 min > 80 min > 100 min > 120 min > OFF

The **SLEEP** time remaining (before TV turn-off) can be seen again at any time by one touch on the remote control **YELLOW** button (A6). A second touch (while the status display is on screen) will modify the **SLEEP** time remaining.

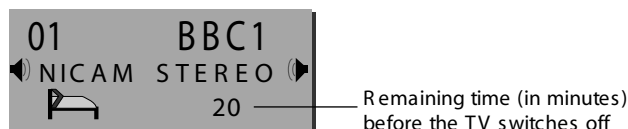

FORMAT SELECTION

AUTO setting: If picture format signalling data is received, then the most appropriate **ZOOM** format will be automatically selected.

Otherwise, the preferred mode of the user can be forced by repeated pressing of the remote control **ZOOM** button (A4): The following picture formats are available:

AUTO > **14:9** > **16:9** > **FULL SCREEN** > **AUTO**.

FEATURES MENU

Select the FEATURES MENU from the main MENU as follows :

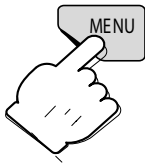

Press on the button **MENU**

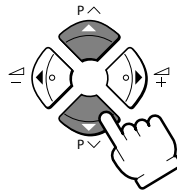

Position cursor on **FEATURES** menu

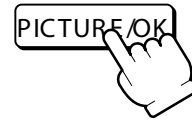

Press on the **OK** button

FEATURES menu content the following sub-menus.

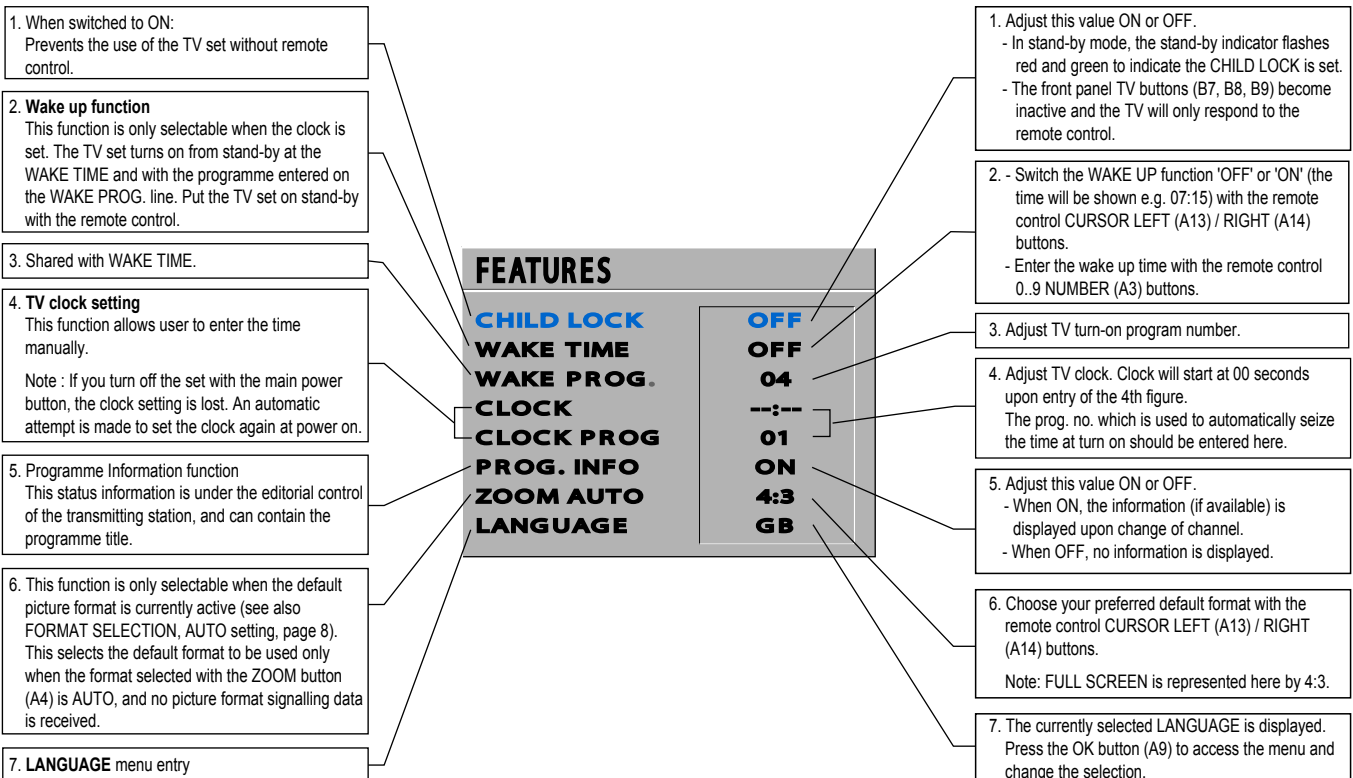

LANGUAGE MENU

Select **LANGUAGE** menu from the FEATURES menu.





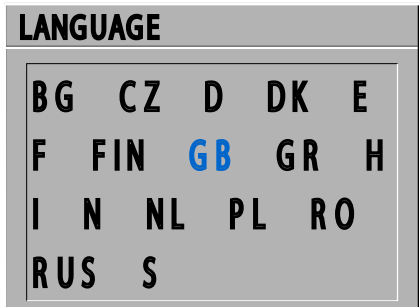

- Select the preferred **LANGUAGE** by use of the **CURSOR LEFT** (A13), **RIGHT** (A14) buttons, and the **CURSOR UP** (A11) or **DOWN** (A12) buttons.
- Press the **OK** button (A9) to confirm the selection (the choice will be highlighted in red).

Note : The languages shown are subject to modification without prior notice.



TELETEXT

ENTERING/LEAVING TELETEXT MODE

- Set the VCR /  / DVD switch (A25) to the  (teletext) position.
- Press the remote control **TELETEXT** () button (A8) to select teletext mode.
- To return to TV mode, press again the **TELETEXT** () button (A8).
- **Note** : Some of the buttons may not work if the VCR /  / DVD) switch is not set to the  (teletext) position.

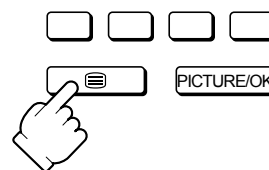

PAGE SELECTION

- You can directly enter the 3 figure page number by using the remote control **NUMBER 0..9** buttons (A3).
- You can sequentially select teletext pages by pressing the remote control **PAGE UP** (A11) / **DOWN** (A12) buttons.

COLOUR buttons FOR TELETEXT

- A red, green, yellow, and blue field is shown at the bottom of the screen. If TOP or FLOF teletext (FASTTEXT) is transmitted by the station, pressing the corresponding colour button on the remote controller, you can select the desired page easily.

Once a request is made, the page number is shown in the extreme top left corner of the screen. If the requested page is not immediately available the rolling header will be active until the page arrives.

USEFUL TELETEXT FUNCTIONS

INDEX button (A23):

Allows you to return directly to the initial teletext page.

PAGE HOLD button (A16)

Several sub pages can be combined under a page number and are scrolled at an interval determined by the television station. The presence of sub pages is indicated by, for example, 3/6 beneath the time, which means that you are looking at the 3rd page of a total of 6 pages. If you want to look at a subpage for a longer period of time, press the **HOLD** button. "" appears at the top of the screen and the contents of the subpage shown are kept on the screen and no longer updated or switched to other subpages. Pressing the **HOLD** button again, the current subpage appear

SUBPAGE button (A24):

Allows you to request a specific subpage:

- Press the **SUBPAGE** button. At the base of the screen a **SUBPAGE** menu will appear. This has a red subpage minus link, a green subpage plus link, plus a white background showing (example for page 110), 110 / 0001. This is ready to accept the subpage number.
- Enter directly the subpage number you want with the remote control **NUMBER 0..9** buttons (A3): for example to request the 2nd subpage, type 0002.
- Alternatively, use the red subpage minus link or the green subpage plus link.
- The subpage number entered is shown at the base of the screen.
- If the requested page is not immediately available the rolling header will be active until the page arrives.

Warning: If the subpage is not available (does not exist), then the header will roll continuously and no new page will be found.

- To exit subpage mode, press the **SUBPAGE** button (A24) again.

Note: Teletext specification allows for subpage numbers 0000 to 3979 (the first figure is limited to the range 0..3, and the third figure 0..7).

DOUBLE SIZE button  (A19)

Repeadly pressing the **SIZE** button doubles the character size in the following order :

Upper half of the page > Lower half of the page > Return to normal size

If the page is in **UP** or **DOWN** mode, then normal size is automatically set if

- A new page request is made (e.g CYAN, INDIX or PAGE UP /DOWN).
- A **CANCEL** mode (A22) function is used.
- **VOLUME** menu is activated with the **MENU** button (A10)

Note ; The menu at the base of the screen is always visible.

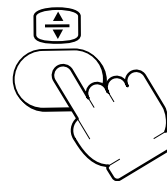
**REVEAL ANSWER button**  (A18)

This fonction can be used on certain pages to reveal the solution of riddles. Press the **REVEAL** button to reveal a hidden answer and press again to hide it.

VOLUME, BRIGHTNESS & CONTRAST CONTROL

VOLUME (and sound MUTE), **BRIGHTNESS** and **CONTRAST** controls are all possible in teletext mode. The **BRIGHTNESS** and **CONTRAST** controls are dedicated to the teletext display.

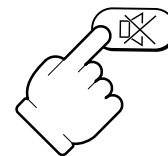
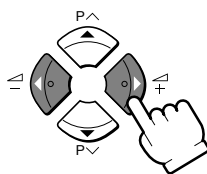

- Access the **VOLUME** control by pressing the **MENU** button (A10) in teletext mode. A bargraph will appear in the lower part of the screen (as in TV mode). If **MUTE** is active, a mute icon is also shown.
- A second press on the **MENU** button (A10) will access the **BRIGHTNESS** control, and a third press the **CONTRAST** control.
- The active bargraph will timeout after 3-4 seconds (as in TV mode VOLUME control) or by pressing on the **MENU** button (A10) a fourth time (after CONTRAST control).



- Each control can be adjusted by using the remote control **CURSOR LEFT** (A13) / **RIGHT** (A14) buttons.
- Mute can always be activated by pressing the **SOUND MUTE** button (A1).
- Any change to the **VOLUME** level will cancel the **SOUND MUTE**.

WATCHING TV WHILE PAGE SEARCHING

The **CANCEL** function can be used to make the teletext page transparent, thus revealing the TV picture:

- To enter cancel mode, press the **CANCEL**  button (A22) while in teletext mode. The TV program will reappear on the screen, while only the teletext page number remains at the top and left corner of the screen.
- You can enter a new page number in this mode only by using the remote control **NUMBER 0..9** buttons (A3), or with the **INDEX**  button (A23).
- If a page has been requested, but has not yet arrived, "???" flashing characters will be displayed until the page arrives. Otherwise, the same characters will be displayed without flashing until the next arrival of the page in the transmission cycle. Once arrived the page number will be displayed.
- The teletext page can be made visible again by pressing the **CANCEL**  button (A22).
- It should be noted that the TV program cannot be changed while in cancel mode.

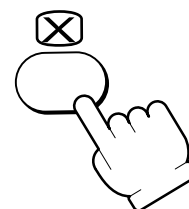

WATCHING TV WITH TELETEXT SUBTITLES

If the actual teletext page is a news flash or subtitle page, then most of the TV picture becomes visible. In this situation the ZOOM format chosen in TV mode is reactivated, where possible.

CONNECTING EXTERNAL EQUIPMENT

The rear Scart EXT-1, Scart EXT-2 sockets, the front EXT-3 socket are three dedicated sockets to connect audio-video equipment.



TV/AV SELECTION

Allows to switch between TV and external modes. By repeatedly pressing the remote control **AV** (A15) or the TV front panel **TV /AV** button (B8), the on-screen display is changed as shown :

EXT-1 > EXT-2 > EXT-2 S > EXT-3 > EXT-3 S > TV

Remark: If the signal source from the rear SCART socket (EXT-1) is RGB (e.g. normally from a DVD player) then EXT-1 RGB will be displayed. You can return to TV mode also by pressing number buttons or PROGRAM UP/DOWN buttons

Rear

VCR / DVD / Video Game / Pay-TV decoder

Important: If your video equipment does not have SCART socket(s), or if you wish to use only the aerial (RF) connection (not recommended), then you should make use of program number 00 on the TV set for best performance.

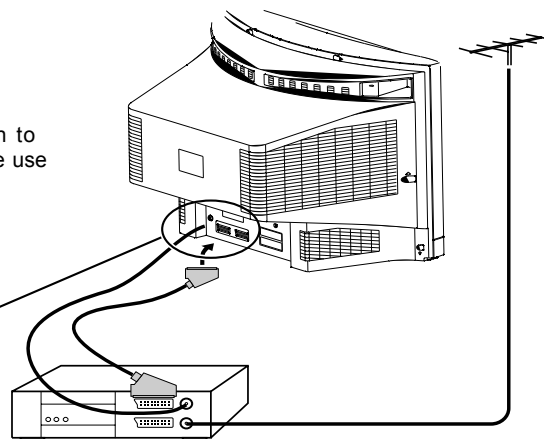
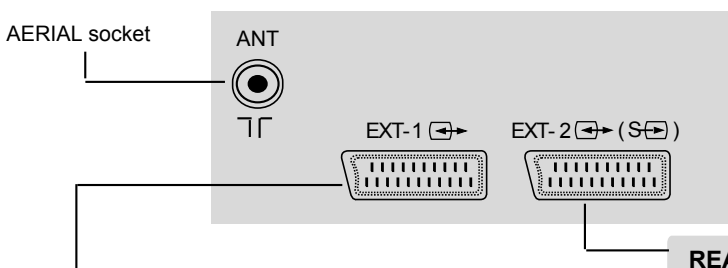

REAR SCART SOCKET (EXT-1)

This socket has video / audio inputs and outputs. It is recommended to connect to this socket automatic AV switching equipment such as pay-TV decoders, video games, DVD players and most VCR's.

This SCART socket doesn't support T-V LINK function. For correct operation, you should not connect any T-V LINK compatible device to this terminal.

In most cases, when connecting powered equipment to this socket, the TV set switches automatically to AV mode. If not, then use the **AV** buttons (A15 or B8) to select **EXT-1**.

REAR SCART SOCKET (EXT-2)

This socket has video / audio inputs and outputs. Automatic AV switching equipment (for example most VCR's) can be connected to this socket. In most cases, when connecting powered equipment to this socket, the TV set switches automatically to AV mode. If not, then use the **AV** buttons (A15 or B8) to select **EXT-2**. You can also receive an **S-VHS** signal by selecting **EXT-2 S** with the **AV** buttons (A15 or B8).

RGB mode is not available on this SCART T-V LINK compatible device must be connected to this terminal.

When a decoder is connected to a T-V LINK compatible VCR, set the DECORDER function to ON. For details, see "Using the DECORDER (EXT-2) function" on page 5. Otherwise, you will not be able to view scrambled channels.

Front

FRONT AV SOCKET (EXT-3)

The front AV socket has audio and video inputs. To switch from TV to these inputs, use the AV buttons (A15 or B8) and select **EXT-3**.

FRONT S-VHS JACK

The front S-VHS jack (B2) has video inputs only. It is necessary to connect the audio inputs to socket (B4) in order to have audio and video. To watch S-VHS from these inputs, use the AV buttons (A15 or B8) and select **EXT-3 S**.

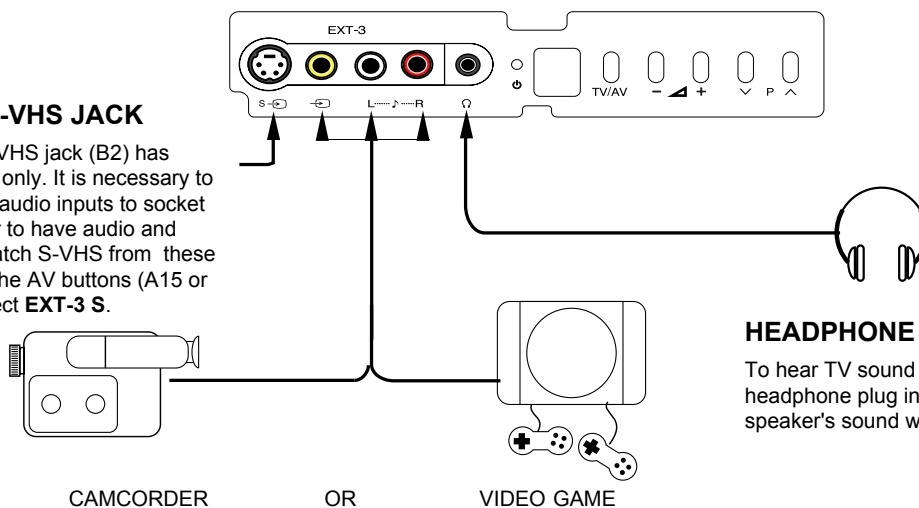

HEADPHONE SOCKET

To hear TV sound with headphones, insert a 3.5mm headphone plug into the headphone socket. The speaker's sound will be automatically cut off.

TROUBLESHOOTING

- If the plug is disconnected from the AC socket, or the TV aerial has problems, you may think there is a problem with the TV itself. Be sure to check the following before calling for service.

IMPORTANT

- Review all instruction in this manual

	PROBLEM	ACTION
■ GENERAL	The TV cannot be turned on.	<ul style="list-style-type: none"> ● Insert the plug in an AC socket. ● Turn the main power on. (See page 3) ● The buttons on the front panel of the TV will not work if the CHILD LOCK is operating (see FEATURES menu, on page 11). Use the POWER button on the remote control to turn the TV on.
	No picture or sound.	<ul style="list-style-type: none"> ● Check aerial connections. (See page 3). ● Select the correct input source (See page 14). ● Change the SYSTEM setting manually (see Manual Channel Tuning on pages 5/6).
	The TV shuts off automatically.	<ul style="list-style-type: none"> ● Did you set the SLEEP function? (See page 10). ● If the broadcast signal is not present for about 30 minutes, the set will be automatically turned off. ● For safety reasons, the TV will automatically turn off if no operations are made within approximately 3 hours after the TV is turned on with the WAKE UP function.
	The TV turns on automatically.	<ul style="list-style-type: none"> ● Did you set the WAKE UP function? (See page 11).
	Inoperable remote control.	<ul style="list-style-type: none"> ● Replace the batteries. (See page 3). ● Insert the batteries correctly. (See page 3). ● Use the remote control within about 7 metres of the TV.
■ PICTURE	Poor colour.	<ul style="list-style-type: none"> ● Change the SYSTEM setting manually (see Manual Channel Tuning on pages 5/6).
	Lines or streaks in picture (interference)	<ul style="list-style-type: none"> ● Move any external equipment away until the interference is eliminated. ● Reposition the aerial.
	Spots (crosstalk)	<ul style="list-style-type: none"> ● Reposition the aerial. ● Replace with an aerial with better directionality.
	Double pictures (ghosts)	<ul style="list-style-type: none"> ● Reposition the aerial. ● Replace with an aerial with better directionality.
	Snowy pictures (noise)	<ul style="list-style-type: none"> ● Check aerial connections. ● Redirect the aerial. ● Replace or repair the aerial.
■ SOUND	No sound from the TV's speakers	<ul style="list-style-type: none"> ● Disconnect the headphones.

The following are normal and are NOT malfunctions:

- When touching the picture tube surface, you might feel a slight charge of static electricity. This is because the picture tube contains static electricity; it does not affect the human body.
- The TV may emit a crackling sound due to a sudden change of temperature. There is no problem unless the picture or sound is abnormal.
- When a still, bright image (of a white dress, for example) appears on the screen, the image may be coloured. This problem occurs in all picture tubes, and as the bright image disappears, the colour also disappears.
- This TV is equipped with a microcomputer that may operate abnormally due to interference from external equipment. If this happens, turn off the main power and disconnect the power cord from the AC socket. Then reconnect the power cord to the AC socket and turn on the main power again.

SPECIFICATIONS

Item	Model	AV-29FH1SUG / AV-29FH1BUG
Broad casting systems		CCIR B/G, I, D/K, L/L'
Colour systems		PAL, SECAM The EXT terminals also support the NTSC 3.58/4.43 MHz system.
Channels and frequencies		* E2-E12, E21-E70, S1-S41, X, Y, Z, Z+1, Z+2, ITALY A-H, ITALY H+1, ITALY H+2, F2-F10, F21-F70, R1-R12, R21-R70 * French cable TV channel of broadcast frequencies 116 - 172 MHz and 220 - 469 MHz
Sound-multiplex systems		A2 (B/G, D/K), NICAM (B/G, D/K, I, L) systems
Teletext systems		FLOF (Fastext) / TOP / WST (World standard system)
Power requirements		AC 220-240V, 50 Hz
Power consumption		84W, stand-by 3W
Picture tube size		Visible area 68cm (measured diagonally)
Audio output		Rated Power output: 7W + 7W
Ext-1 terminal		Euroconnector (21-pin, SCART) * Video input, Audio L/R inputs and RGB inputs are available * TV broadcast outputs (Video and Audio L/R) are available.
Ext-2 terminal		Euroconnector (21-pin, SCART) * Video input, S-VIDEO (Y/C) input, Audio L/R inputs are available * Video and Audio L/R outputs are available * T-V LINK functions are available
Ext-3 terminal		RCA connectors x 3 S-VIDEO connector x 1 * Video input, S-VIDEO (Y/C) input and Audio L/R inputs are available.
Headphone jack		Stereo mini-jack (3.5mm in diameter)
Dimensions (W x H x D)		812 mm x 600 mm x 522 mm
Weight		40 kg
Remote control unit		RM-C1514, battery AA / R6 x 2

Design and specifications are subject to change without notice

Pictures displayed on the screen using this TV's image processing functions should not be shown for any commercial or demonstration purpose in public places (tearooms and halls in hotels, etc.) without the consent of the owners of copyright of the original picture sources, as this constitutes an infringement of copyright.