



深圳秋田视佳实业有限公司
SHENZHEN AV-DISPLAY CO., LTD

深圳秋田视佳实业有限公司
 地址：深圳市华侨城东部工业区文昌街东北 C-7 栋
 电话:(086)0755-26919178 传真:(086)0755-26911092
 网址：[Http://www.av-display.com.cn](http://www.av-display.com.cn)

SHENZHEN AV-DISPLAY CO.,LTD
 Address: North East C-7 Building, Wenchang Street
 Eastern District, OCT, ShenZhen, China
 TEL: (086)0755-26919178 FAX: (086)0755-26911092
[Http://www.av-display.com.cn](http://www.av-display.com.cn)

SPECIFICATION FOR LCM MODULE

MODULE NO.: AV-G12864D1-A201
DOC.REVISION 01

Customer Approval:

--

	SIGNATURE	DATE
PREPARED BY (RD ENGINEER)		Mar-01-2005
PREPARED BY (QA ENGINEER)		
CHECKED BY		
APPROVED BY		



深圳秋田视佳实业有限公司
SHENZHEN AV-DISPLAY CO., LTD

DOCUMENT REVISION HISTORY

Version	DATE	DESCRIPTION	CHANGED BY
00	Apr-1-2004	First issue	
01	Mar-1-2005	Modify format	



CONTENTS

1. Functions & Features	2
2. Mechanical specifications	2
3. Block diagram	2
4. Dimensional Outline	3
5. Pin description	4
6. Maximum absolute limit	4
7. Electrical characteristics	5
8. Timing Characteristics	6
9. Reset Timing	6
10. Control and display command	7
11. Backlight drawing & specification	7
12. Electro-Optical characteristics	8
13. Quality Specifications	8-17



深圳秋田视佳实业有限公司
SHENZHEN AV-DISPLAY CO., LTD

1. FUNCTIONS & FEATURES

1.1. Format	: 128x64dots
1.2. LCD mode	: STN / Positive transfective Mode / Yellow-green
1.3. Viewing direction	: 6 o'clock
1.4. Driving scheme	: 1/64 Duty cycle, 1/9 Bias
1.5. Power operation	: Power supply voltage range (V_{DD}): 5.0V
1.6. VLCD adjustable for best contrast	: LCD driving voltage: 9.2V
1.7. Operation temp	: -20~70 °C
1.8. Storage temp	: -30~80 °C
1.9. Backlight color	: Yellow-green

2. MECHANICAL SPECIFICATIONS

2.1. Module size	: 75mm(L)*52.8mm(W)*9.0mm(H)
2.2. Viewing area	: 60.0mm(L)*32.6mm(W)
2.3. Dot pitch	: 0.43mm(L)*0.43mm(W)
2.4. Dot size	: 0.40mm(L)*0.40mm(W)
2.5. Weight	: Approx.

3. BLOCK DIAGRAM

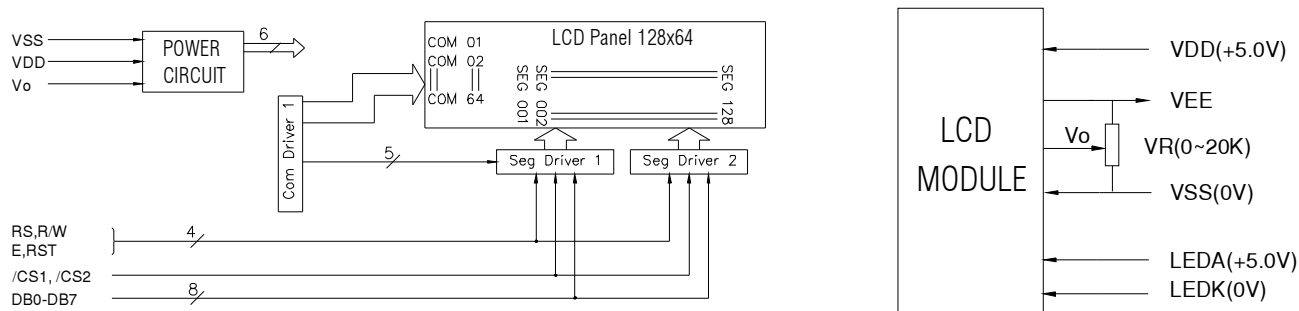

Figure 1. Block diagram



深圳秋田视佳实业有限公司
SHENZHEN AV-DISPLAY CO., LTD

4. DIMENSIONAL OUTLINE

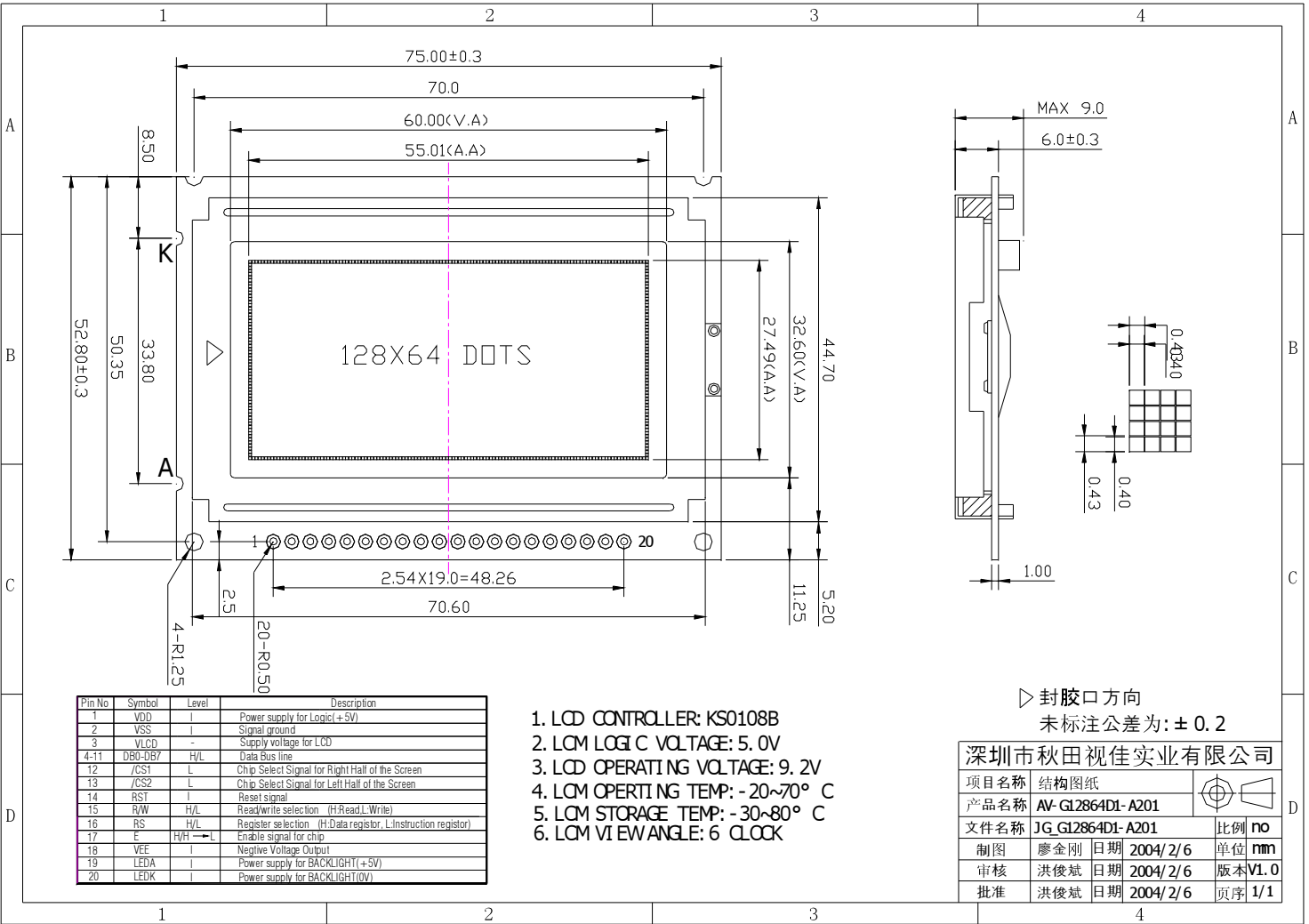

Figure 2. Dimensional outline



5. PIN DESCRIPTION

No.	Symbol	Function
1	VDD	Power supply for logic(+5v)
2	VSS	Power supply for logic (GND)
3	VLCD	Power supply for LCD
4-11	D0—D7	8 bit Data-bus
12	/CS1	Chip select for half-right screen
13	/CS2	Chip select for half-left screen
14	RST	Reset Signal, low level of RET is for reset
15	R/W	Read/Write R/W=high: Data of DB0~DB7 can be read by CPU. R/W=low: Data of DB0~DB7 can be written into LCD driver IC at the falling edge of E when CS1 and CS2 is high.
16	RS	Data/Instruction RS=high: Indicates that data of DB0~DB7 is display data. RS=low: Indicates that data of DB0~DB7 is instruction
17	E	Enable When write(R/W=low): Data of DB0~DB7 is latched at the fall of E When read(R/W=high): Data is read while E is at high level.
18	VEE	Output of supply negative voltage by the DC-DC converter on the modul
19	LEDA	Power supply for backlight(+5.0V)
20	LEDK	Power supply for backlight(0V)

6. MAXIMUM ABSOLUTE LIMIT

Maximum Ratings (Voltage Reference to VSS)

MAXIMUM ABSOLUTE LIMIT

Characteristic	Symbol	Value	Unit	Note
Operating Voltage	V _{DD}	-0.3~+7.0	V	*1
Supply Voltage	V _{EE}	V _{DD} -19.0~V _{DD} +0.3	V	*4
Driver Supply Voltage	V _B	-0.3~V _{DD} +0.3	V	*1,3
	V _{LCD}	V _{EE} -0.3~V _{DD} +0.3	V	*2
Operating Temperature	T _{OPR}	-30~+85	°C	
Storage Temperature	T _{STG}	-55~+125	°C	

*1. Based on V_{SS}=0V.

*2. Applies the same supply voltage to V_{EE1} and V_{EE2}. V_{LCD}=V_{DD}-V_{EE}.

*3. Applies to M, FRM, CL, RSTB, ADC, CLK1, CLK2, CS1B, CS2B, CS3, E, R/W, RS and DB0~DB7.

*4. Applies to V0L(R), V2L(R), V3L(R) and V5L(R).

Voltage level: V_{DD} ≥ V0L = V0R ≥ V2L = V2R ≥ V3L = V3R ≥ V5L = V5R ≥ V_{EE}.



7. ELECTRICAL CHARACTERISTICS

DC Characteristics ($V_{DD}=+5V \pm 10\%$, $V_{SS}=0V$, $V_{DD}-V_{EE}=8\sim 17V$, $T_a=-30\sim +85^\circ C$)

Characteristic	Symbol	Condition	Min	Typ	Max	Unit	Note
Input High Voltage	V_{IH1}	-	$0.7V_{DD}$	-	V_{DD}	V	*1
	V_{IH2}	-	2.0	-	V_{DD}	V	*2
Input Low Voltage	V_{IL1}	-	0	-	$0.3V_{DD}$	V	*1
	V_{IL2}	-	0	-	0.8	V	*2
Output High Voltage	V_{OH}	$I_{OH}=-200\mu A$	2.4	-	-	V	*3
Output Low Voltage	V_{OL}	$I_{OL}=1.6mA$	-	-	0.4	V	*3
Input Leakage Current	I_{LKG}	$V_{IN}=V_{SS}\sim V_{DD}$	-1.0	-	1.0	μA	*4
Three-state(OFF) Input Current	I_{TSL}	$V_{IN}=V_{SS}\sim V_{DD}$	-5.0	-	5.0	μA	*5
Driver Input Leakage Current	I_{DIL}	$V_{IN}=V_{EE}\sim V_{DD}$	-2.0	-	2.0	μA	*6
Operating Current	I_{DD1}	During Display	-	-	100	μA	*7
	I_{DD2}	During Access Access Cycle=1MHz	-	-	500	μA	*7
On Resistance	R_{ON}	$V_{DD}-V_{EE}=15V$ $I_{LOAD}=\pm 0.1mA$	-	-	7.5	$K\Omega$	*8

*1. CL, FRM, M, RSTB, CLK1, CLK2

*2. CS1B, CS2B, CS3, E, R/W, RS, DB0~DB7

*3. DB0~DB7

*4. Except DB0~DB7

*5. DB0~DB7 at High Impedance

*6. V0L(R), V2L(R), V3L(R), V5L(R)

*7. 1/64 duty, FCLK=250KHZ, Frame Frequency=70HZ, Output: No Load

*8. $V_{DD}\sim V_{EE}=15.5V$

$V_{0L}(R)>V_{2L}(R)=V_{DD}-2/7$ ($V_{DD}-V_{EE}>V_{3L}(R)=V_{EE}+2/7(V_{DD}-V_{EE})>V_{5L}(R)$)



8. TIMING CHARACTERISTICS

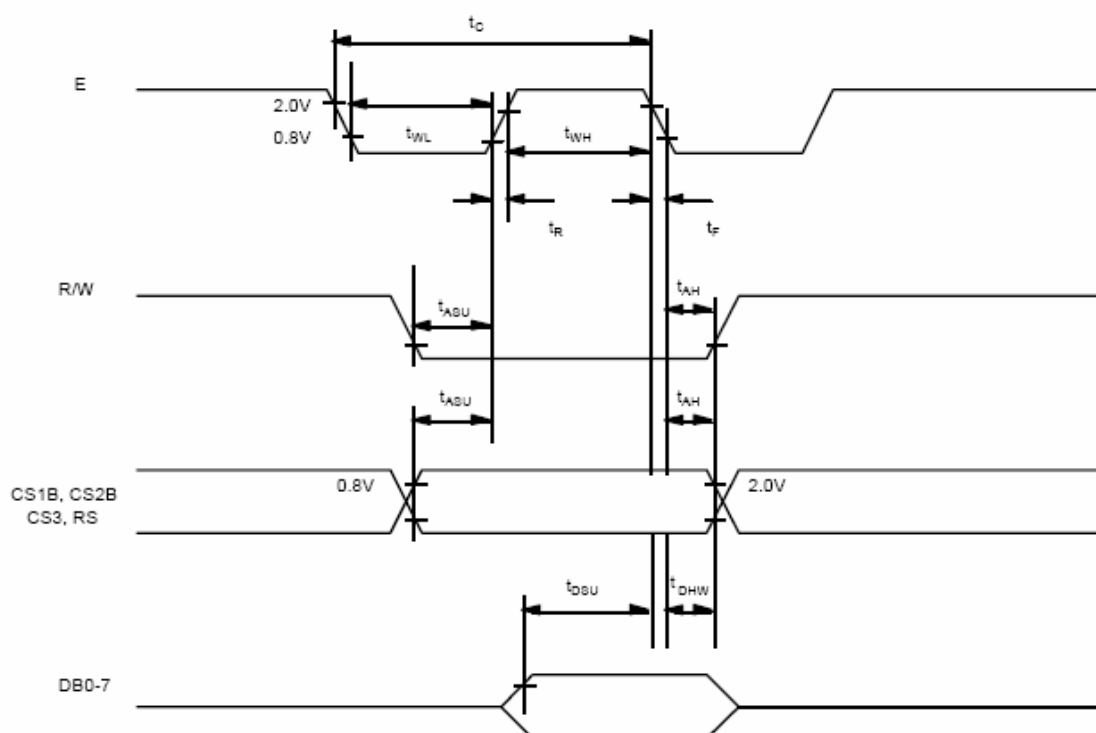

9. Reset Timing

This block includes Power On Reset circuitry and the hardware reset pin, RES#. Both of these have the same reset function. Once RES# receives a negative reset pulse, all internal circuitry will start to initialize. Minimum pulse width for completing the reset sequence is 1us.

The system can be initialized by setting RSTB terminal at low level when turning power on, receiving instruction from MPU. When RSTB becomes low, following procedure is occurred.

1. Display off
2. Display start line register become set by 0.(Z-address 0)

While RSTB is low, No instruction except status read can be accepted. Therefore, execute other instructions after making sure that DB4=0 (clear RSTB) and DB7=0 (ready) by status read instruction.

The Conditions of power supply at initial power up are shown in table 1.

Table 1. Power Supply Initial Conditions

Item	Symbol	Min	Typ	Max	Unit
Reset Time	t_{RS}	1.0	-	-	us
Rise Time	t_R	-	-	200	ns

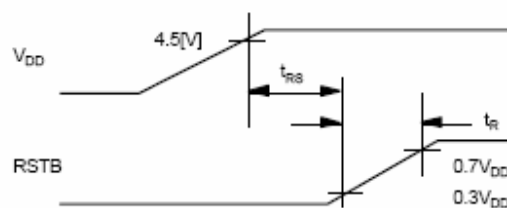



深圳秋田视佳实业有限公司

SHENZHEN AV-DISPLAY CO., LTD

10. CONTROL AND DISPLAY INSTRUCTION

The display control instructions control the internal state of the KS0108B. Instruction is received from MPU to KS0108B for the display control. The following table shows various instructions.

Instruction	RS	R/W	DB7	DB6	DB5	DB4	DB3	DB2	DB1	DB0	Function
Display ON/OFF	L	L	L	L	H	H	H	H	H	L/H	Controls the display on or off. Internal status and display RAM data is not affected. L:OFF, H:ON
Set Address (Y address)	L	L	L	H	Y address (0~63)					Sets the Y address in the Y address counter.	
Set Page (X address)	L	L	H	L	H	H	H	Page (0~7)		Sets the X address at the X address register.	
Display Start Line (Z address)	L	L	H	H	Display start line (0~63)					Indicates the display data RAM displayed at the top of the screen.	
Status Read	L	H	B U S Y	L	O N / O F F	R E S E T	L	L	L	L	Read status. BUSY L: Ready H: In operation ON/OFF L: Display ON H: Display OFF RESET L: Normal H: Reset
Write Display Data	H	L	Write Data								Writes data (DB0:7) into display data RAM. After writing instruction, Y address is increased by 1 automatically.
Read Display Data	H	H	Read Data								Reads data (DB0:7) from display data RAM to the data bus.

11. BACK LIGHT CHARACTERISTICS

LCD Module with Bottom LED Backlight
ELECTRICAL RATINGS

Ta = 25°C

Item	Symbol	Condition	Min	Typ	Max	Unit
Forward Voltage	VF	IF=150mA	---	4.2	4.35	V
Reverse Current	IR	VR=10V	---	---	0.1	mA
Luminous Intensity (With LCD dots off)	IV	IF=150mA	---	40	---	Cd/m ²
Wave length	λp	IF=150mA	---	572	---	nm
Color	Yellow-green					



12. ELECTRO-OPTICAL CHARACTERISTICS

($V_{OP} = 9.2V$, $T_a = 25^\circ C$)

Item	Symbol	Condition	Min	Typ	Max	Unit
Operating Voltage	Vop	Ta = -20°C	9.5	9.7	10.0	V
		Ta = 25°C	9.0	9.2	9.4	
		Ta = 70°C	8.5	8.7	9.0	
Response time	Tr	Ta = 25°C	---	185	---	ms
	Tf		---	200	---	ms
Contrast	Cr	Ta = 25°C	---	4	---	---
Viewing angle range	θ	Cr ≥ 2	-40	---	+40	deg
	Φ		-40	---	+40	deg

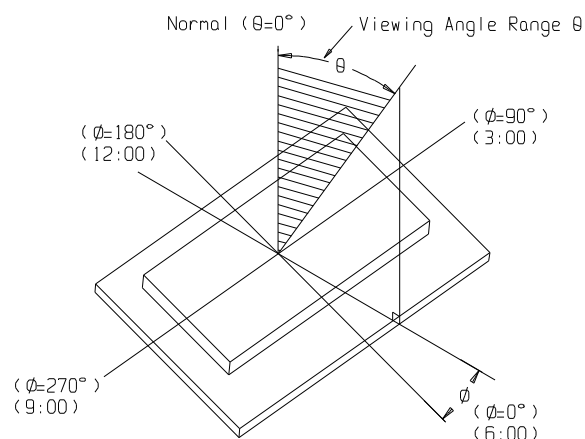
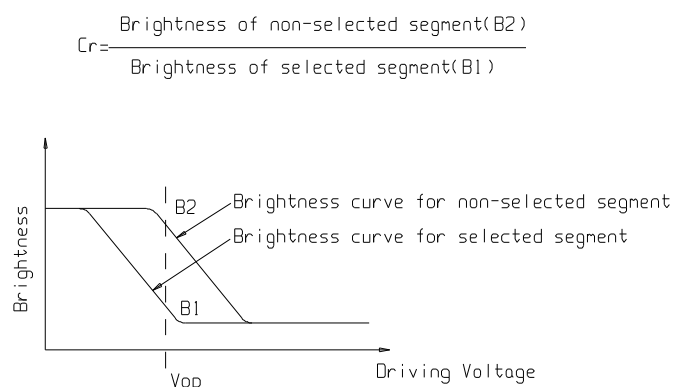

13. QUALITY SPECIFICATIONS

13.1 Standard of the product appearance test

Manner of appearance test: The inspection should be performed in using 20W x 2 fluorescent lamps. Distance between LCM and fluorescent lamps should be 100 cm or more. Distance between LCM and inspector eyes should be 30 cm or more.

Viewing direction for inspection is 45° from vertical against LCM.



深圳秋田视佳实业有限公司
SHENZHEN AV-DISPLAY CO., LTD

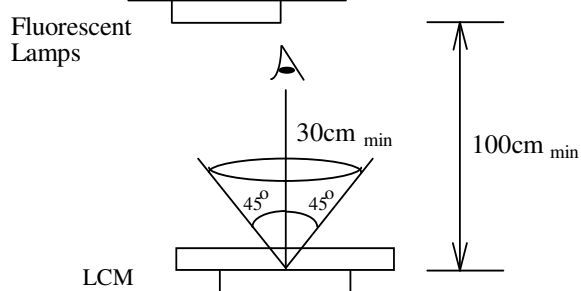

Definition of zone:

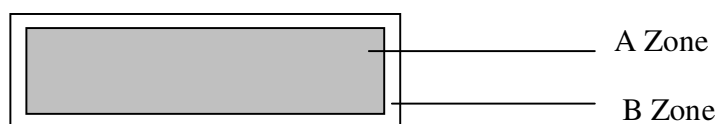

A Zone: Active display area (minimum viewing area).

B Zone: Non-active display area (outside viewing area).

13.2 Specification of quality assurance

AQL inspection standard

Sampling method: MIL-STD-105E, Level II, single sampling

Defect classification (**Note: * is not including**)

Classify	Item		Note	AQL
Major	Display state	Short or open circuit	1	0.65
		LC leakage		
		Flickering		
		No display		
		Wrong viewing direction		



深圳秋田视佳实业有限公司
SHENZHEN AV-DISPLAY CO., LTD

		Contrast defect (dim, ghost)	2	
		Back-light	1,8	
	Non-display	Flat cable or pin reverse	10	
		Wrong or missing component	11	
Minor	Display state	Background color deviation	2	1.0
		Black spot and dust	3	
		Line defect, Scratch	4	
		Rainbow	5	
		Chip	6	
		Pin hole	7	
	Polarizer	Protruded	12	
		Bubble and foreign material	3	
	Soldering	Poor connection	9	
	Wire	Poor connection	10	
	TAB	Position, Bonding strength	13	

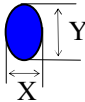
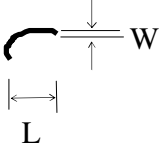

Note on defect classification

No.	Item	Criterion																			
1	Short or open circuit	Not allow																			
	LC leakage																				
	Flickering																				
	No display																				
	Wrong viewing direction																				
	Wrong Back-light																				
2	Contrast defect	Refer to approval sample																			
	Background color deviation																				
3	Point defect, Black spot, dust (including Polarizer) $\phi = (X+Y)/2$	 <table border="1" data-bbox="919 1003 1342 1292"> <thead> <tr> <th>Point Size</th> <th>Acceptable Qty.</th> </tr> </thead> <tbody> <tr> <td>$\phi \leq 0.10$</td> <td>Disregard</td> </tr> <tr> <td>$0.10 < \phi \leq 0.20$</td> <td>3</td> </tr> <tr> <td>$0.20 < \phi \leq 0.25$</td> <td>2</td> </tr> <tr> <td>$0.25 < \phi \leq 0.30$</td> <td>1</td> </tr> <tr> <td>$\phi > 0.30$</td> <td>0</td> </tr> </tbody> </table> <p>Unit: mm</p>	Point Size	Acceptable Qty.	$\phi \leq 0.10$	Disregard	$0.10 < \phi \leq 0.20$	3	$0.20 < \phi \leq 0.25$	2	$0.25 < \phi \leq 0.30$	1	$\phi > 0.30$	0							
Point Size	Acceptable Qty.																				
$\phi \leq 0.10$	Disregard																				
$0.10 < \phi \leq 0.20$	3																				
$0.20 < \phi \leq 0.25$	2																				
$0.25 < \phi \leq 0.30$	1																				
$\phi > 0.30$	0																				
4	Line defect, Scratch	 <table border="1" data-bbox="849 1462 1382 1715"> <thead> <tr> <th colspan="2">Line</th> <th rowspan="2">Acceptable Qty.</th> </tr> <tr> <th>L</th> <th>W</th> </tr> </thead> <tbody> <tr> <td>---</td> <td>$0.015 \geq W$</td> <td>Disregard</td> </tr> <tr> <td>$3.0 \geq L$</td> <td>$0.03 \geq W$</td> <td rowspan="2">2</td> </tr> <tr> <td>$2.0 \geq L$</td> <td>$0.05 \geq W$</td> </tr> <tr> <td>$1.0 \geq L$</td> <td>$0.1 > W$</td> <td>1</td> </tr> <tr> <td>---</td> <td>$0.05 < W$</td> <td>Applied as point defect</td> </tr> </tbody> </table> <p>Unit: mm</p>	Line		Acceptable Qty.	L	W	---	$0.015 \geq W$	Disregard	$3.0 \geq L$	$0.03 \geq W$	2	$2.0 \geq L$	$0.05 \geq W$	$1.0 \geq L$	$0.1 > W$	1	---	$0.05 < W$	Applied as point defect
		Line		Acceptable Qty.																	
L	W																				
---	$0.015 \geq W$	Disregard																			
$3.0 \geq L$	$0.03 \geq W$	2																			
$2.0 \geq L$	$0.05 \geq W$																				
$1.0 \geq L$	$0.1 > W$	1																			
---	$0.05 < W$	Applied as point defect																			
5	Rainbow	Not more than two color changes across the viewing area.																			

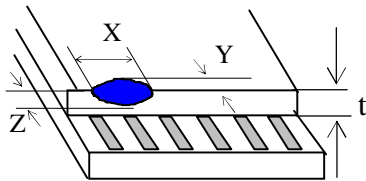
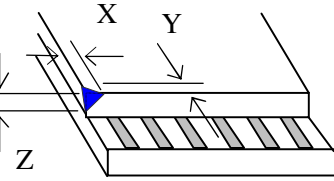
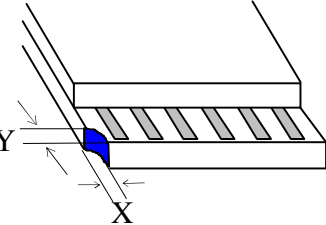
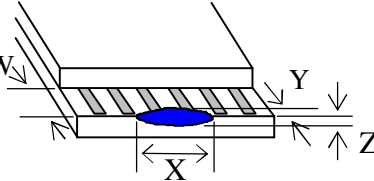
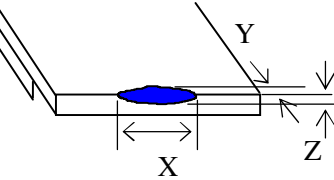

深圳秋田视佳实业有限公司
SHENZHEN AV-DISPLAY CO., LTD

No	Item	Criterion																																	
6	<p>Chip</p> <p>Remark: X: Length direction Y: Short direction Z: Thickness direction t: Glass thickness W: Terminal Width</p>	 <table border="1"> <caption>Acceptable criterion</caption> <thead> <tr> <th>X</th> <th>Y</th> <th>Z</th> </tr> </thead> <tbody> <tr> <td>≤ 2</td> <td>0.5mm</td> <td>$\leq t/2$</td> </tr> </tbody> </table>  <table border="1"> <caption>Acceptable criterion</caption> <thead> <tr> <th>X</th> <th>Y</th> <th>Z</th> </tr> </thead> <tbody> <tr> <td>≤ 2</td> <td>0.5mm</td> <td>$\leq t$</td> </tr> </tbody> </table>  <table border="1"> <caption>Acceptable criterion</caption> <thead> <tr> <th>X</th> <th>Y</th> <th>Z</th> </tr> </thead> <tbody> <tr> <td>≤ 3</td> <td>≤ 2</td> <td>$\leq t$</td> </tr> <tr> <td colspan="2">shall not reach to ITO</td> <td></td> </tr> </tbody> </table>  <table border="1"> <caption>Acceptable criterion</caption> <thead> <tr> <th>X</th> <th>Y</th> <th>Z</th> </tr> </thead> <tbody> <tr> <td>Disregard</td> <td>≤ 0.2</td> <td>$\leq t$</td> </tr> </tbody> </table>  <table border="1"> <caption>Acceptable criterion</caption> <thead> <tr> <th>X</th> <th>Y</th> <th>Z</th> </tr> </thead> <tbody> <tr> <td>≤ 5</td> <td>≤ 2</td> <td>$\leq t/3$</td> </tr> </tbody> </table>	X	Y	Z	≤ 2	0.5mm	$\leq t/2$	X	Y	Z	≤ 2	0.5mm	$\leq t$	X	Y	Z	≤ 3	≤ 2	$\leq t$	shall not reach to ITO			X	Y	Z	Disregard	≤ 0.2	$\leq t$	X	Y	Z	≤ 5	≤ 2	$\leq t/3$
X	Y	Z																																	
≤ 2	0.5mm	$\leq t/2$																																	
X	Y	Z																																	
≤ 2	0.5mm	$\leq t$																																	
X	Y	Z																																	
≤ 3	≤ 2	$\leq t$																																	
shall not reach to ITO																																			
X	Y	Z																																	
Disregard	≤ 0.2	$\leq t$																																	
X	Y	Z																																	
≤ 5	≤ 2	$\leq t/3$																																	

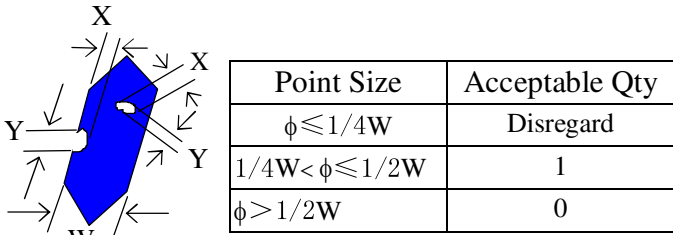
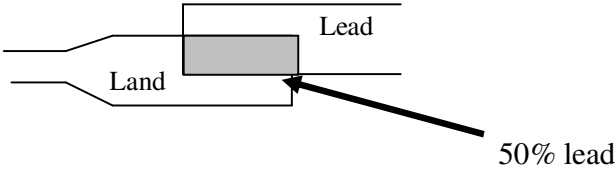

No.	Item	Criterion								
7	Segment pattern W = Segment width $\phi = (X+Y)/2$	<p>(1) Pin hole $\phi < 0.10\text{mm}$ is acceptable.</p>  <table border="1" data-bbox="911 667 1358 840"> <thead> <tr> <th>Point Size</th> <th>Acceptable Qty</th> </tr> </thead> <tbody> <tr> <td>$\phi \leq 1/4W$</td> <td>Disregard</td> </tr> <tr> <td>$1/4W < \phi \leq 1/2W$</td> <td>1</td> </tr> <tr> <td>$\phi > 1/2W$</td> <td>0</td> </tr> </tbody> </table> <p>Unit: mm</p>	Point Size	Acceptable Qty	$\phi \leq 1/4W$	Disregard	$1/4W < \phi \leq 1/2W$	1	$\phi > 1/2W$	0
Point Size	Acceptable Qty									
$\phi \leq 1/4W$	Disregard									
$1/4W < \phi \leq 1/2W$	1									
$\phi > 1/2W$	0									
8	Back-light	<p>(1) The color of backlight should correspond its specification. (2) Not allow flickering</p>								
9	Soldering	<p>(1) Not allow heavy dirty and solder ball on PCB. (The size of dirty refer to point and dust defect) (2) Over 50% of lead should be soldered on Land.</p> 								
10	Wire	<p>(1) Copper wire should not be rusted (2) Not allow crack on copper wire connection. (3) Not allow reversing the position of the flat cable. (4) Not allow exposed copper wire inside the flat cable.</p>								
11*	PCB	<p>(1) Not allow screw rust or damage. (2) Not allow missing or wrong putting of component.</p>								

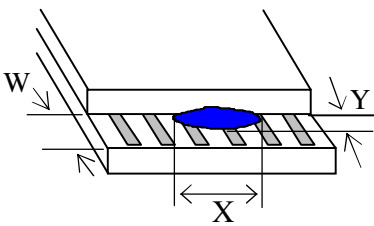
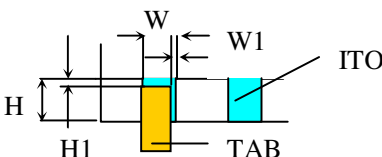
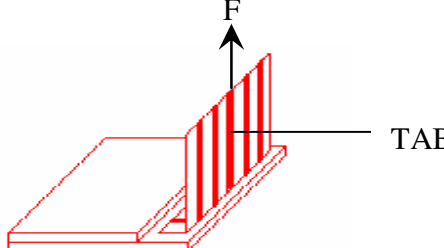
No	Item	Criterion
12	Protruded W: Terminal Width	 <p>Acceptable criteria: $Y \leq 0.4$</p>
13	TAB	<p>1. Position</p>  <div style="border: 1px solid black; padding: 5px; width: fit-content; margin-left: auto; margin-right: auto;"> $W1 \leq 1/3W$ $H1 \leq 1/3H$ </div> <p>2 TAB bonding strength test</p>  <p>$P (=F/\text{TAB bonding width}) \geq 650\text{gf/cm}$, (speed rate: 1mm/min) 5pcs per SOA (shipment)</p>
14	Total no. of acceptable Defect	<p>A. Zone</p> <p>Maximum 2 minor non-conformities per one unit. Defect distance: each point to be separated over 10mm</p> <p>B. Zone</p> <p>It is acceptable when it is no trouble for quality and assembly in customer's end product.</p>



13.3 Reliability of LCM

Reliability test condition:

Item	Condition	Time (hrs)	Assessment
High temp. Storage	80°C	48	No abnormalities in functions and appearance
High temp. Operating	70°C	48	
Low temp. Storage	-30°C	48	
Low temp. Operating	-20°C	48	
Humidity	40°C/ 90%RH	48	
Temp. Cycle	0°C ← 25°C → 50°C (30 min ← 5 min → 30min)	10cycles	

Recovery time should be 24 hours minimum. Moreover, functions, performance and appearance shall be free from remarkable deterioration within 50,000 hours under ordinary operating and storage conditions room temperature ($20\pm 8^{\circ}\text{C}$), normal humidity (below 65% RH), and in the area not exposed to direct sun light.

13.4 Precaution for using LCD/LCM

LCD/LCM is assembled and adjusted with a high degree of precision. Do not attempt to make any alteration or modification. The followings should be noted.

General Precautions:

1. LCD panel is made of glass. Avoid excessive mechanical shock or applying strong pressure onto the surface of display area.
2. The polarizer used on the display surface is easily scratched and damaged. Extreme care should be taken when handling. To clean dust or dirt off the display surface, wipe gently with cotton, or other soft material soaked with isopropyl alcohol, ethyl alcohol or trichlorotrifluoroethane, do not use water, ketone or aromatics and never scrub hard.
3. Do not tamper in any way with the tabs on the metal frame.
4. Do not made any modification on the PCB without consulting AV.
5. When mounting a LCM, make sure that the PCB is not under any stress such as bending or twisting. Elastomer contacts are very delicate and missing pixels could result from slight dislocation of any of the elements.



深圳秋田视佳实业有限公司
SHENZHEN AV-DISPLAY CO., LTD

6. Avoid pressing on the metal bezel, otherwise the elastomer connector could be deformed and lose contact, resulting in missing pixels and also cause rainbow on the display.
7. Be careful not to touch or swallow liquid crystal that might leak from a damaged cell. Any liquid crystal adheres to skin or clothes, wash it off immediately with soap and water.

Static Electricity Precautions:

1. CMOS-LSI is used for the module circuit; therefore operators should be grounded whenever he/she comes into contact with the module.
2. Do not touch any of the conductive parts such as the LSI pads; the copper leads on the PCB and the interface terminals with any parts of the human body.
3. Do not touch the connection terminals of the display with bare hand; it will cause disconnection or defective insulation of terminals.
4. The modules should be kept in anti-static bags or other containers resistant to static for storage.
5. Only properly grounded soldering irons should be used.
6. If an electric screwdriver is used, it should be grounded and shielded to prevent sparks.
7. The normal static prevention measures should be observed for work clothes and working benches.
8. Since dry air is inductive to static, a relative humidity of 50-60% is recommended.

Soldering Precautions:

1. Soldering should be performed only on the I/O terminals.
2. Use soldering irons with proper grounding and no leakage.
3. Soldering temperature: $280^{\circ}\text{C} \pm 10^{\circ}\text{C}$
4. Soldering time: 3 to 4 second.
5. Use eutectic solder with resin flux filling.
6. If flux is used, the LCD surface should be protected to avoid spattering flux.
7. Flux residue should be removed.

Operation Precautions:

1. The viewing angle can be adjusted by varying the LCD driving voltage V_o .
2. Since applied DC voltage causes electro-chemical reactions, which deteriorate the display, the applied pulse waveform should be a symmetric waveform such that no DC component remains. Be sure to use the specified operating voltage.
3. Driving voltage should be kept within specified range; excess voltage will shorten display life.
4. Response time increases with decrease in temperature.
5. Display color may be affected at temperatures above its operational range.
6. Keep the temperature within the specified range usage and storage. Excessive temperature and humidity could cause polarization degradation, polarizer peel-off or generate bubbles.
7. For long-term storage over 40°C is required, the relative humidity should be kept below 60%, and avoid direct sunlight.



深圳秋田视佳实业有限公司
SHENZHEN AV-DISPLAY CO., LTD

Limited Warranty

AV LCDs and modules are not consumer products, but may be incorporated by AV's customers into consumer products or components thereof, AV does not warrant that its LCDs and components are fit for any such particular purpose.

1. The liability of AV is limited to repair or replacement on the terms set forth below. AV will not be responsible for any subsequent or consequential events or injury or damage to any personnel or user including third party personnel and/or user. Unless otherwise agreed in writing between AV and the customer, AV will only replace or repair any of its LCD which is found defective electrically or visually when inspected in accordance with AV general LCD inspection standard . (Copies available on request)
2. No warranty can be granted if any of the precautions state in handling liquid crystal display above has been disregarded. Broken glass, scratches on polarizer mechanical damages as well as defects that are caused accelerated environment tests are excluded from warranty.
3. In returning the LCD/LCM, they must be properly packaged; there should be detailed description of the failures or defect.