

HIP3™ Variable Attenuator for UMTS Base Stations



AV133-315

Features

- 23 dB Attenuation Range
- 1.5 dB Insertion Loss, 1.5 SWR
- 0–12 V Control Voltage
- 43 dBm IP3
- Small Footprint LGA Package
- Designed for UMTS Base Stations

Description

The AV133-315 is a voltage controlled variable attenuator from Alpha's series of HIP3™ components. It is specifically designed and specified for use as a wide dynamic range low distortion attenuator for UMTS base station applications centered at 2140 MHz. The AV133-315 employs a monolithic quadrature hybrid and a pair of silicon PIN diodes to achieve the specified low distortion performance. It operates from 0–12 V at 1.6 mA typical control current at maximum attenuation. The AV133-315 is packaged in a small outline LGA (Land Grid Array) surface mount package with the internal elements affixed to an organic BT substrate.

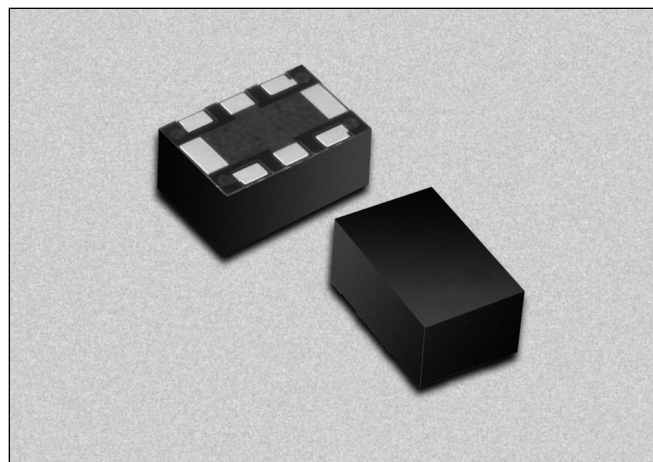

Electrical Specifications at 25°C

Parameter	Condition	Min.	Typ.	Max.	Unit
UMTS Frequency Range (BW)	$F_O \pm 12.5$ MHz	2110		2170	MHz
Control Voltage (C_V) Range		0		12	V
Insertion Loss in BW	$C_V = 0$ V			1.5	dB
Attenuation Range	At F_O , $C_V = 12$ V	23			dB
VSWR in BW				1.5	
IP3	2140/2145 MHz, $C_V = 0$ V	43			dBm
IM3	8 dBm			-70	dBc

Typical Performance Data

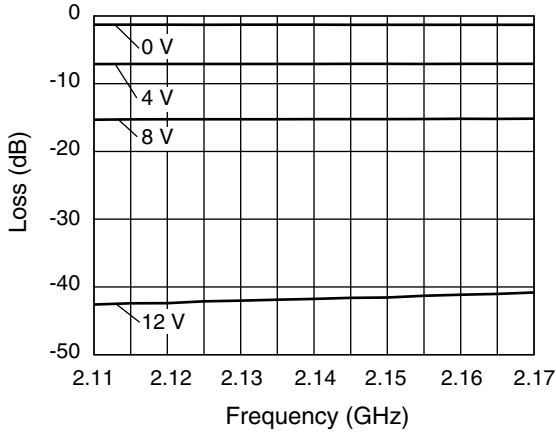

Insertion Loss vs. Frequency and Control Voltage — UMTS Band

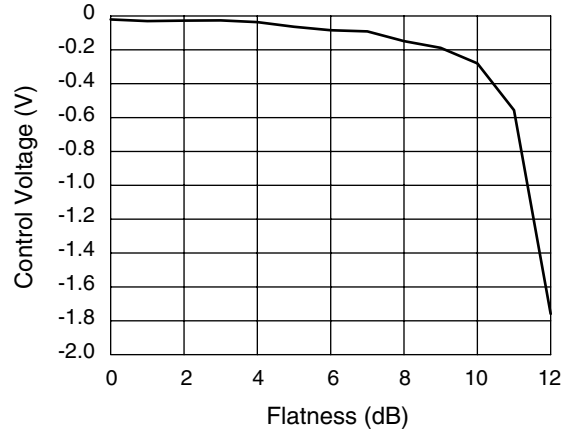

Insertion Loss Flatness vs. Control Voltage — UMTS Band

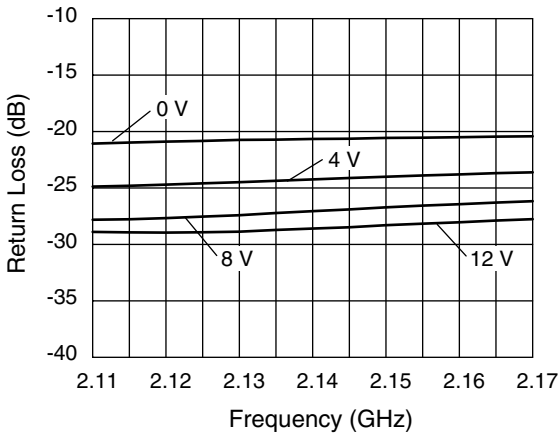

Input/Output Return Loss vs. Frequency and Control Voltage — UMTS Band

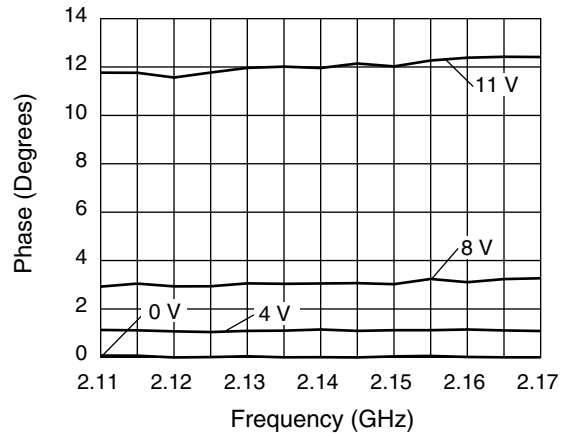

Phase vs. Frequency and Control Voltage — UMTS Band

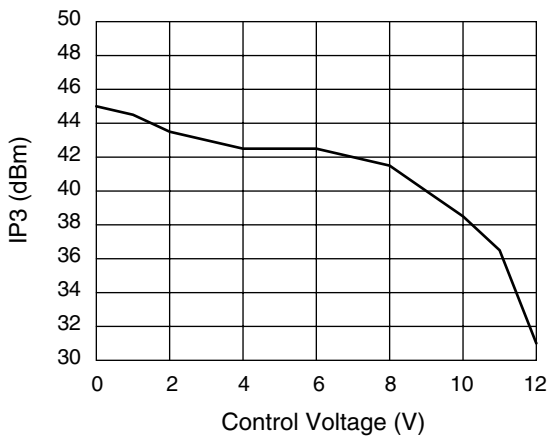

3rd Order Intermod Intercept vs. Control Voltage
RF₁ = 2.140 GHz, RF₂ = 2.145 GHz @ 8 dBm

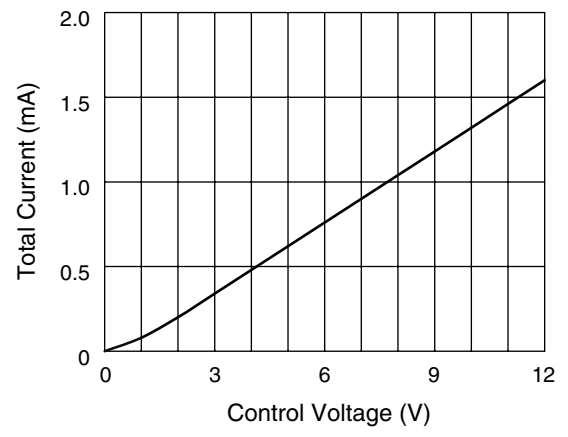

Total Current vs. Control Voltage

Pin Out (Bottom View)

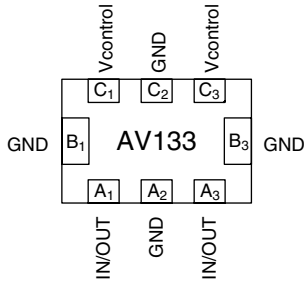

Terminal No.	Terminal Name
A ₁	IN/OUT
A ₂	GND
A ₃	IN/OUT
B ₁	GND
B ₃	GND
C ₁	Vcontrol
C ₂	GND
C ₃	Vcontrol

Absolute Maximum Ratings

Characteristic	Value
RF Input Power	0.5 W CW, 4 W @ 12.5% Duty Cycle
Control Voltage	15 V
Control Current	50 mA Each Diode
Operating Temperature	-40 to +85°C
Storage Temperature	-40 to +85°C
Maximum Reverse Diode Voltage	-10 V
Electrostatic Discharge	+125 V

Note: Operating this device above any of these parameters may cause irreversible damage.

Connection Diagram

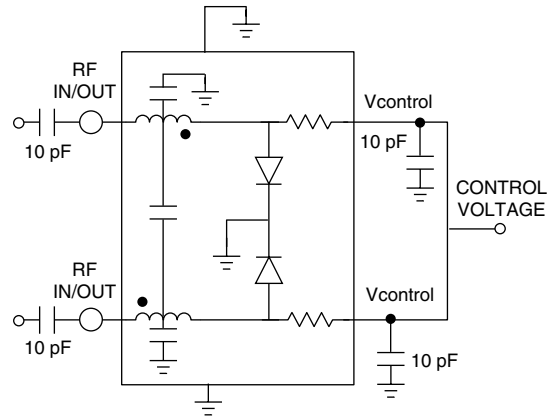

-315

