





Modular Type Filter Regulator Series AW

Filter regulator Series AW	Model	Port size	Filtration	Accessory
 <p data-bbox="114 779 400 813">Pages 56 through 60</p>	AW10	M5 x 0.8	5μm	Bracket Square embedded type pressure gauge (except for AR10) Round pressure gauge Panel mount
	AW20	1/8, 1/4		
	AW30	1/4, 3/8		
	AW40	1/4, 3/8, 1/2		
	AW40-06	3/4		
	 <p data-bbox="114 1198 400 1227">Pages 63 through 66</p>	AW20K		
AW30K		1/4, 3/8		
AW40K		1/4, 3/8, 1/2		
AW40K-06		3/4		
 <p data-bbox="114 1646 400 1675">Pages 67 through 70</p>	AWM20	1/8, 1/4	0.3μm (95% filtered particle size)	Bracket Square embedded type pressure gauge (except for AR10) Round pressure gauge Panel mount
	AWM30	1/4, 3/8		
	AWM40	1/4, 3/8, 1/2		
 <p data-bbox="114 2094 400 2119">Pages 71 through 74</p>	AWD20	1/8, 1/4	0.01μm (95% filtered particle size)	Bracket Square embedded type pressure gauge (except for AR10) Round pressure gauge Panel mount
	AWD30	1/4, 3/8		
	AWD40	1/4, 3/8, 1/2		

Filter Regulator AW10 to 40

Integrated filter and regulator units save space and require less piping.

Direct operated, relieving type

JIS symbol

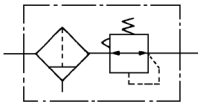

Page 61



AW20



AW40

How to Order

AW 30 — **F 03** **BE** — **1N**

Filter regulator

Body size

10 20 30 40

Thread type

Nil	Metric thread (M5)
	Rc
N Note 1)	NPT
F Note 2)	G



Note 1) Drain guide is NPT1/4 (applicable to AW30 and 40), and the exhaust port for auto drain comes with $\phi 3/8"$ One-touch fitting (applicable to AW30 and AW40).

Note 2) Drain guide is G1/4 (applicable to AW30 and AW40).

Port size

Symbol	Port size	Body size			
		10	20	30	40
M5	M5	●	—	—	—
01	1/8	—	●	—	—
02	1/4	—	●	●	●
03	3/8	—	—	●	●
04	1/2	—	—	—	●
06	3/4	—	—	—	●

Optional specifications

Symbol	Description	Applicable model
1 ^{Note 5)}	0.02 to 0.2MPa setting	AW10 to 40
2	Metal bowl	AW10 to 40
6	Nylon bowl	AW10 to 40
8	Metal bowl with level gauge	AW30, 40
C	With bowl guard	AW20
J ^{Note 6)}	Drain guide 1/4	AW30, 40
N	Non-relieving	AW10 to 40
R	Flow direction: Right to left	AW10 to 40
W	Drain cock with barb fitting: $\phi 6 \times \phi 4$ nylon tubing	AW30, 40
Z ^{Note 7)}	Name plate, caution plate for bowl, and pressure gauge in imperial units (PSI, °F)	AW10 to 40



* When more than one specification is required, indicate in alphanumeric order.
 Note 5) The only difference from the standard specifications is the adjusting spring for the regulator. It does not restrict the setting of 0.2MPa or more.
 Note 6) Without a valve function.
 Note 7) For M5 and NPT thread types.
 This product is for overseas use only according to the new Measurement Law. (The SI unit type is provided for use in Japan.)

Accessories^{Note 3)}

Symbol	Description	Applicable model
Nil	—	—
B	With bracket	AW10 to 40
C	Float type auto drain (N.C.) ^{Note 4)}	AW10 to 40
D	Float type auto drain (N.O.) ^{Note 4)}	AW30, 40
E	With square embedded type pressure gauge (with limit indicator)	AW20 to 40
G	With round pressure gauge (without limit indicator)	AW10
	With round pressure gauge (with limit indicator)	AW20 to 40
H	With set nut (for panel mount)	AW10 to 40



Note 3) Optional parts are not assembled and are supplied loose at the time of shipment (except for options C, D and E).

Note 4) Applicable tube O.D for auto drain connection should be $\phi 3/8"$ in case NPT thread port is chosen.

Accessory/Optional specification combinations

⊙ : Combination available

■ : Combination not available

○ : Varies depending on the model

△ : Available only with NPT thread

Accessory/Optional specifications	Combination	Symbol	Accessory							Optional specification							Applicable filter regulator				
			B	C	D	E	G	H	1	2	6	8	C	J	N	R	W	Z	AW10	AW20	AW30 to 40
Accessories	With bracket (with set nut)	B	⊙	⊙	○	○	○	○	○	○	○	○	○	○	○	○	○	△	○	○	○
	Float type auto drain (N.C.)	C	⊙	■	■	○	○	○	○	○	○	○	○	○	○	○	○	△	○	○	○
	Float type auto drain (N.O.)	D	⊙	■	■	○	○	○	○	○	○	○	○	○	○	○	○	△	■	■	○
	Square embedded type pressure gauge	E	⊙	○	○	○	○	○	○	○	○	○	○	○	○	○	○	△	■	■	○
	Round pressure gauge	G	⊙	○	○	○	○	○	○	○	○	○	○	○	○	○	○	△	○	○	○
	With set nut (for panel mount)	H	⊙	○	○	○	○	○	○	○	○	○	○	○	○	○	○	△	○	○	○
Optional specifications	0.02 to 0.2MPa setting	-1	⊙	⊙	○	○	○	○	○	○	○	○	○	○	○	○	○	△	○	○	○
	Metal bowl	-2	⊙	○	○	○	○	○	○	○	○	○	○	○	○	○	○	△	○	○	○
	Nylon bowl	-6	⊙	○	○	○	○	○	○	○	○	○	○	○	○	○	○	△	○	○	○
	Metal bowl with level gauge	-8	⊙	○	○	○	○	○	○	○	○	○	○	○	○	○	○	△	■	■	○
	With bowl guard	-C	⊙	○	○	○	○	○	○	○	○	○	○	○	○	○	○	△	○	○	○
	Drain guide 1/4	-J	⊙	○	○	○	○	○	○	○	○	○	○	○	○	○	○	△	■	■	○
	Non-relieving type	-N	⊙	○	○	○	○	○	○	○	○	○	○	○	○	○	○	△	○	○	○
	Flow direction: Right to left	-R	⊙	○	○	○	○	○	○	○	○	○	○	○	○	○	○	△	○	○	○
	Drain cock with barb fitting: $\phi 6 \times \phi 4$ nylon tubing	-W	⊙	○	○	○	○	○	○	○	○	○	○	○	○	○	○	△	○	○	○
	Name plate, caution plate for bowl, and pressure gauge in imperial units (PSI, °F)	-Z	△	△	△	△	△	△	△	△	△	△	△	△	△	△	△	△	△	△	△

AW10 to 40

Standard specifications

Model	AW10	AW20	AW30	AW40	AW40-06
Port sizes	M5 x 0.8	1/8, 1/4	1/4, 3/8	1/4, 3/8, 1/2	3/4
Fluid	Air				
Proof pressure	1.5MPa				
Maximum operating pressure	1.0MPa				
Set pressure range	0.05 to 0.7MPa	0.05 to 0.85MPa			
Pressure gauge port size ^{Note 1)}	Rc 1/16 ^{Note 2)}	Rc, NPT, G 1/8	Rc, NPT, G 1/8	Rc, NPT, G 1/4	Rc, NPT, G 1/4
Relief pressure	Set pressure + 0.05MPa ^{Note 3)} [at relief flow rate of 0.1L/min (ANR)]				
Ambient and fluid temperature	-5 to 60°C (with no freezing)				
Nominal filtration rating	5µm				
Drain capacity (cm ³)	2.5	8	25	45	45
Bowl material	Polycarbonate				
Bowl guard	—	Option	Standard		
Construction	Relieving type				
Weight (kg)	0.09	0.32	0.40	0.72	0.75

Note 1) Pressure gauge connection threads are not required for regulators with a square embedded type pressure gauge (AW20 to AW40).

Note 2) Use a bushing (part no: 131368) when connecting R 1/8 pressure gauge to R 1/16 gauge port.

Note 3) Not applicable to AW10.

Accessory part no.

Applicable model		AW10	AW20	AW30	AW40	AW40-06			
Accessory									
Bracket assembly ^{Note 1)}		AR10P-270AS	AW20P-270AS	AR30P-270AS	AR40P-270AS	AR40P-270AS			
Set nut		AR10P-260S	AR20P-260S	AR30P-260S	AR40P-260S	AR40P-260S			
Pressure gauge	1.0MPa	Round	G27-10-R1	G36-10-□01	G36-10-□01	G46-10-□02	G46-10-□02		
		Square embedded type ^{Note 4)}	—	GC3-10AS	GC3-10AS	GC3-10AS	GC3-10AS		
	0.2MPa	Round	G27-10-R1 ^{Note 3)}	G36-2-□01	G36-2-□01	G46-2-□02	G46-2-□02		
		Square embedded type ^{Note 4)}	—	GC3-2AS	GC3-2AS	GC3-2AS	GC3-2AS		
Float type auto drain ^{Note 5)}	N.O.	—	—	AD38	AD38N ^{Note 6)}	AD48	AD48N ^{Note 6)}	AD48	AD48N ^{Note 6)}
	N.C.	AD17	AD27	AD37	AD37N ^{Note 6)}	AD47	AD47N ^{Note 6)}	AD47	AD47N ^{Note 6)}

Note 1) Assembly includes a bracket and set nuts.

Note 2) □ in part numbers for a round pressure gauge indicates a type of connection thread. No indication is necessary for R; however, indicate N for NPT. Contact P/A regarding the connection thread NPT and supply of the pressure gauge for PSI unit specifications.

Note 3) For 1MPa.

Note 4) Includes one O-ring and 2 mounting screws.

Note 5) Minimum operating pressure: N.O. type-0.1MPa; N.C. type-0.1MPa (AD17/27) and 0.15MPa (AD37/47). Contact P/A regarding the specifications for PSI unit and "F".

Note 6) When "N" is specified in the end of part number of auto drain, applicable tube O.D should be ø3/8".

⚠ Specific Product Precautions

Be sure to read before handling. Refer to pages 75 through 78 for safety instructions and F.R.L. unit precautions.

Selection

⚠ Warning

- Residual pressure release (outlet pressure release) is not completed by releasing inlet pressure. To release residual pressure, use a filter regulator with a back flow mechanism.

Maintenance

⚠ Warning

- Replace the element every 2 years or when the pressure drop becomes 0.1MPa, whichever comes first, to prevent damage to the element.

Mounting & Adjustment

⚠ Warning

- Set the regulator while checking the displayed values of the inlet and outlet pressure gauges. Turning the knob excessively can cause damage to the internal parts.
- The pressure gauge indicated with regulators for 0.02 to 0.2MPa setting is for 0.2MPa use only. Exceeding 0.2MPa of pressure can damage the gauge.
- Do not use tools on the pressure regulator knob as this may cause damage. It must be operated manually.

⚠ Caution

- Be sure to unlock the knob before adjusting the pressure and lock it after setting the pressure. Failure to follow this procedure can cause damage to the knob and the outlet pressure may fluctuate.

- Pull the pressure regulator knob to unlock. (You can visually verify this with the "orange mark" that appears in the gap.)
- Push the pressure regulator knob to lock. When the knob is not easily locked, turn it left and right a little and then push it (when the knob is locked, the "orange mark" will disappear).



- A knob cover is available to prevent careless operation of the knob. Refer to Features 1 for details.

Flow Characteristics (Representative values)

Condition: Inlet pressure 0.7MPa

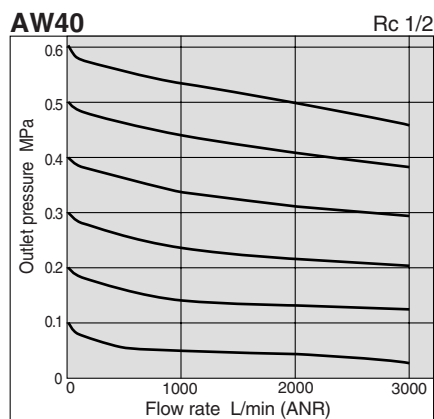
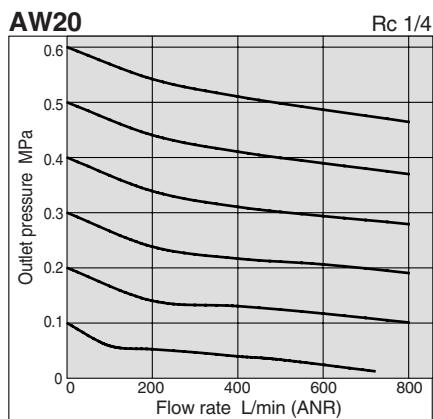
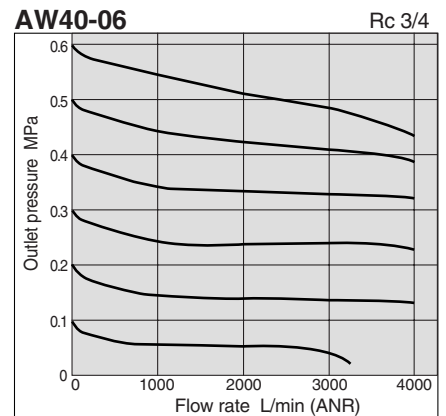
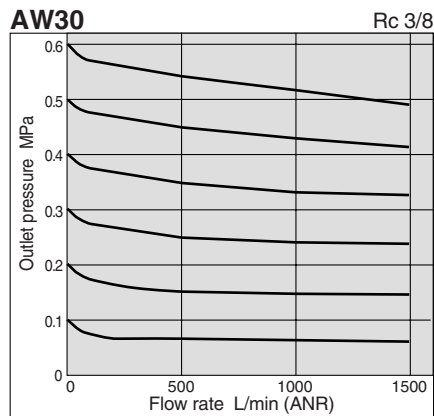
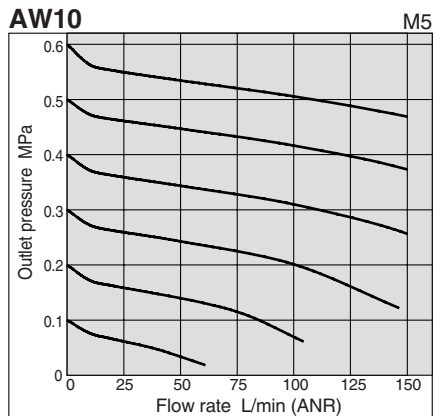

Pressure Characteristics (Representative value)

Conditions: Inlet pressure 0.7MPa; Outlet pressure 0.2MPa; Flow rate 20L/min (ANR)

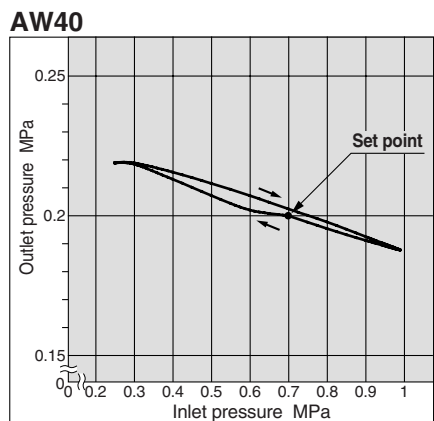
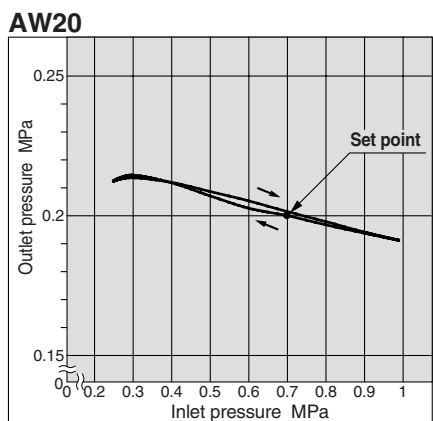
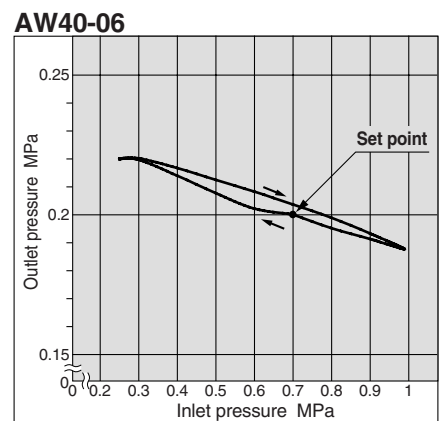
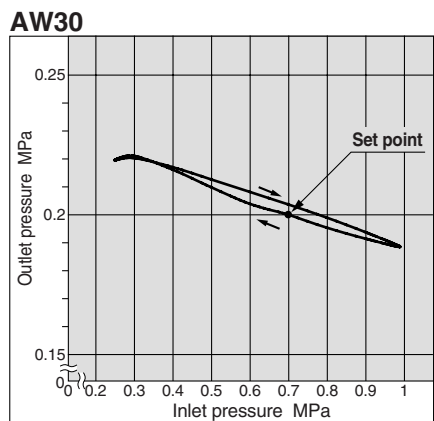
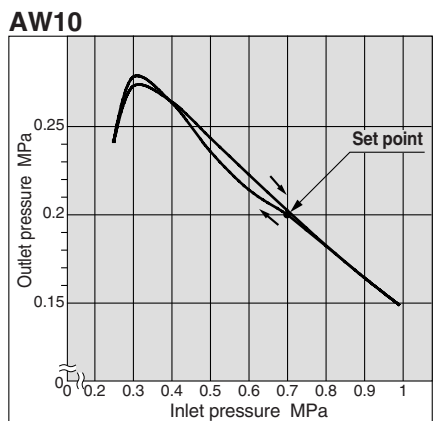

AW10 to 40

Construction

JIS symbol

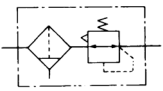

AW10

AW20

AW30, 40

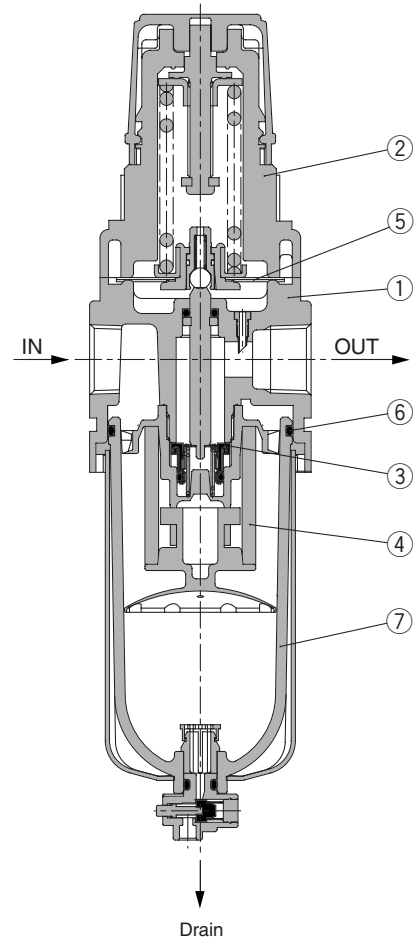
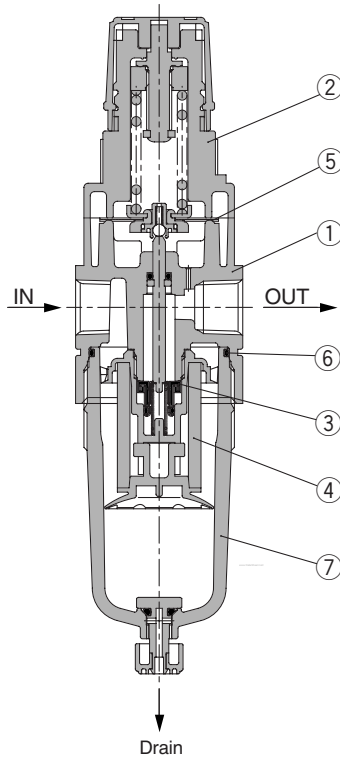
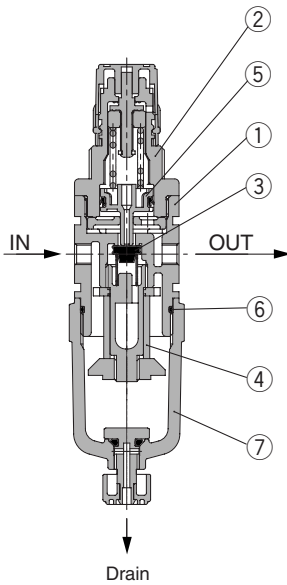

Parts list

No.	Description	Material			Note
		AW10, 20	AW30	AW40, 40-06	
1	Body	Zinc die-cast	Aluminum die-cast		Platinum silver
2	Bonnet	Polyacetal			Black

Replacement parts

No.	Description	Material	Part no.				
			AW10	AW20	AW30	AW40	AW40-06
3	Valve assembly	Stainless steel Brass, HNBR	AR10P-090S	AW20P-090AS	AW30P-090AS	AW40P-090AS	AW40P-090AS
4	Filter element	Non-woven fabric	AF10P-060S	AF20P-060S	AF30P-060S	AF40P-060S	AF40P-060S
5	Diaphragm assembly	Weatherability NBR	AR10P-150AS ^{Note 1)}	AR20P-150AS	AR30P-150AS	AR40P-150AS	AR40P-150AS
6	Bowl O-ring	NBR	C1SFP-260S	C2SFP-260S	C3SFP-260S	C4SFP-260S	C4SFP-260S
7	Bowl assembly ^{Note 2)}	PC	C1SF	C2SF	C3SF ^{Note 3)}	C4SF ^{Note 3)}	C4SF ^{Note 3)}



Note 1) AW10 is a piston and a gasket (KSYP-13) type assembly.

Note 2) Including O-Ring. Contact P/A regarding the bowl assembly supply for PSI and °F unit specifications.

Note 3) The AW30 and AW40 bowl assembly comes with a bowl guard (steel band material).

Dimensions

AW10, 20

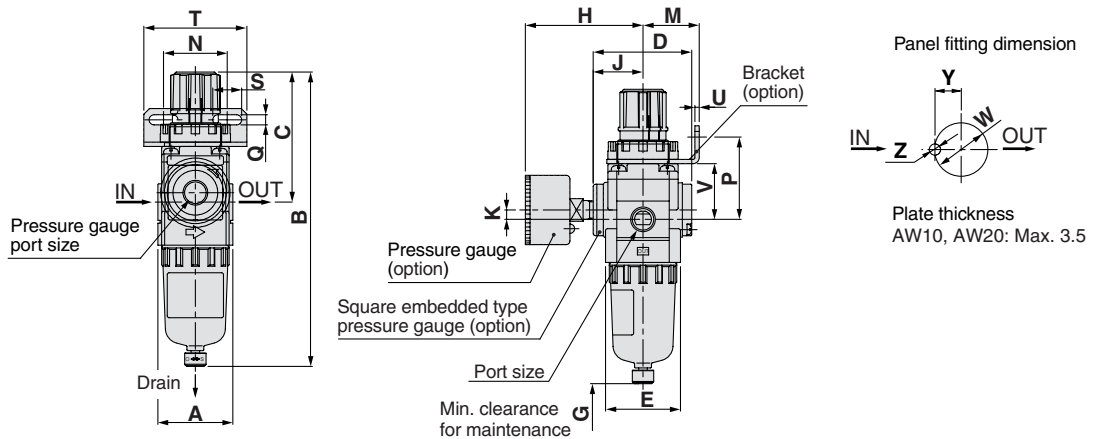

AW30, 40

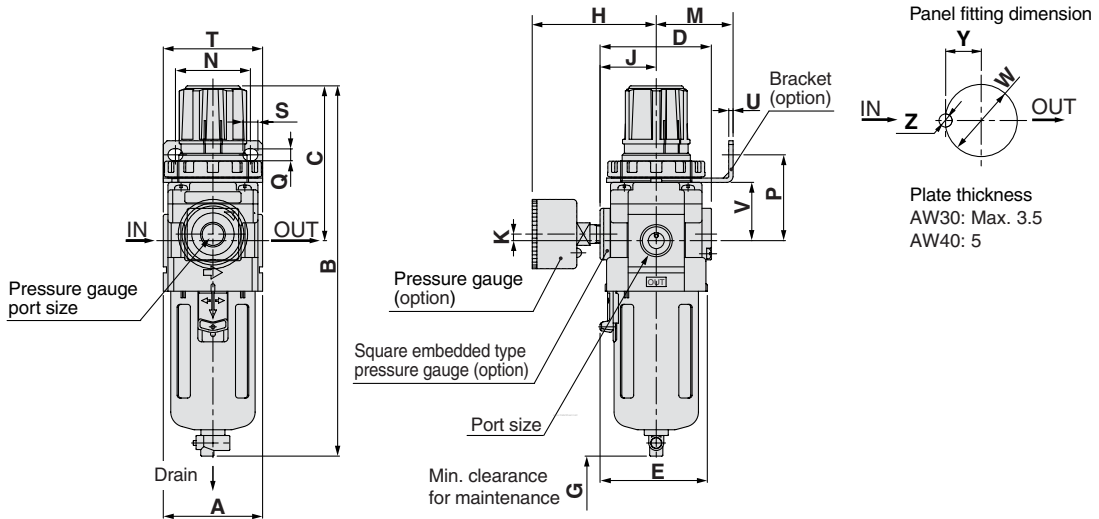

Applicable model	AW10, AW20				AW30, AW40, AW40-06			
Optional specifications	With auto drain (N.C.)	Metal bowl	With auto drain (N.O./N.C.)	Metal bowl	Metal bowl with level gauge	With drain guide	Drain cock with barb fitting	
	M5 x 0.8		N.O.: Black N.C.: Gray ø10 One-touch fitting			1/4 Width across flats 17	Barb fitting Applicable tubing: T0604	

Model	Port size	Standard specification						Accessory specification														
		A	B	C	D	E	G	With pressure gauge			Bracket mounting size						Panel mount			With auto drain		
								H	J	K	M	N	P	Q	S	T	U	V	W	Y	Z	B
AW10	M5 x 0.8	25	108	48	25	28	25	26	—	0	25	28	30	4.5	6.5	40	2	18	18.5	—	—	125
AW20	1/8, 1/4	40	160	73	52	40	40	63	27	5	30	34	44	5.4	15.4	55	2.3	30	28.5	14	6	177
AW30	1/4, 3/8	53	201	86	59	57	55	66	30.5	3.5	41	40	46	6.5	8	53	2.3	31	38.5	19	7	242
AW40	1/4, 3/8, 1/2	70	239	92	75	73	80	76	38.5	1.5	50	54	54	8.5	10.5	70	2.3	35.5	42.5	21	7	278
AW40-06	3/4	75	242	93	75	73	80	76	38.5	1.2	50	54	56	8.5	10.5	70	2.3	37	42.5	21	7	278

Model	Optional specification			
	With barb fitting	With drain guide	Metal bowl	Metal bowl with level gauge
	B	B	B	B
AW10	—	—	107	—
AW20	—	—	160	—
AW30	209	208	214	234
AW40	247	246	251	272
AW40-06	250	249	255	275

Filter Regulator AW20 to 40 Made to Order Specifications

Contact P/A for detailed dimensions, specifications, and lead times.



① Special Temperature Environment

Special materials are used in the manufacturing of seals and resin parts to allow them to withstand various temperature conditions in cold or tropical (hot) regions.

Specifications

Part no.	-X430	-X440
Environment	Low temperature	High temperature
Ambient temperature	-30 to 60°C	-5 to 80°C
Fluid temperature	-5 to 60°C (with no freezing)	
Material	Rubber parts	Special NBR
	Main parts	FPM
	Aluminum die-cast	

Applicable models

Model	AW30	AW40	AW40-06
Port size	1/4, 3/8	1/4, 3/8, 1/2	3/4

How to Order

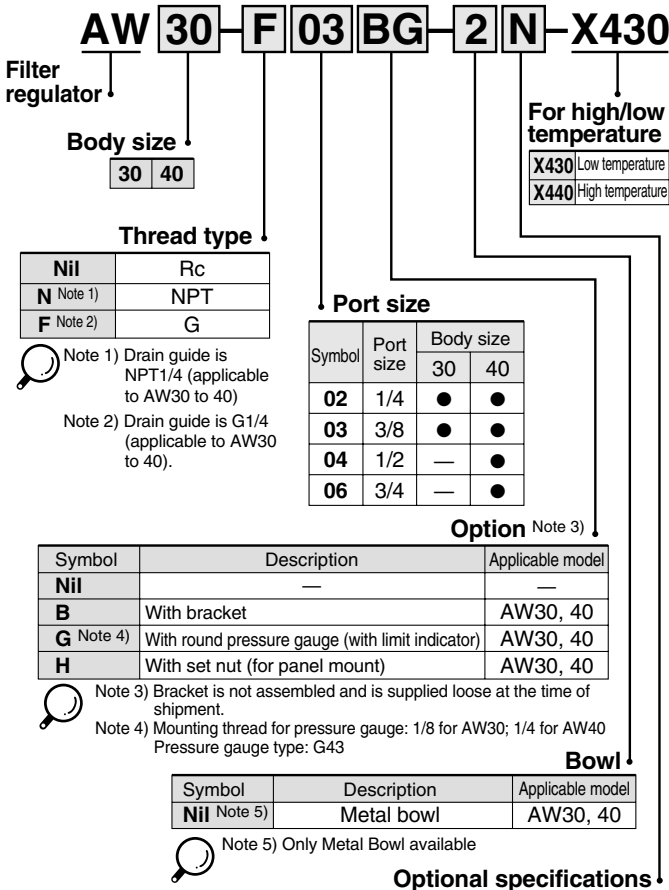

② High Pressure

Strong materials are used in the manufacturing of air filters intended for high pressure operation.

Specifications

Part no.	-X425
Proof pressure	3.0MPa
Maximum operating pressure	2.0MPa
Set pressure range	0.1 to 1.6MPa
Ambient and fluid temperature	-5 to 60°C (with no freezing)



Applicable models

Model	AW20	AW30	AW40	AW40-06
Port size	1/8, 1/4	1/4, 3/8	1/4, 3/8, 1/2	3/4

How to Order

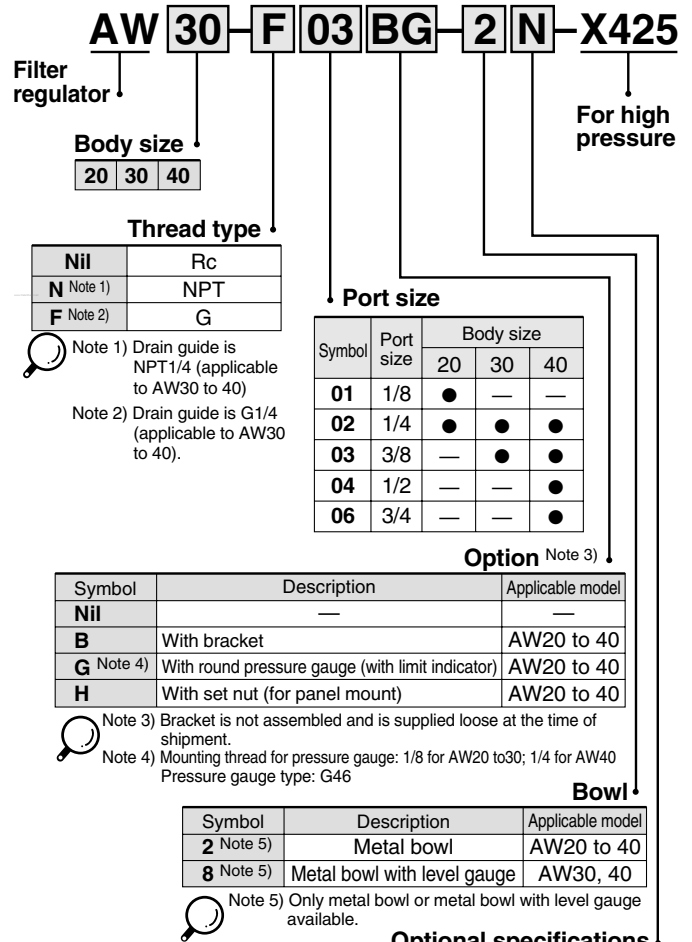

* When more than one specification is required, indicate in ascending alphanumeric order.
Note 6) The only difference from the standard specifications is the adjusting spring for the regulator. It does not restrict the setting of 0.2MPa or more.
Note 7) Without a valve function.
Note 8) For thread type NPT.
This product is for overseas use only according to the new Measurement Law. (The SI unit type is provided for use in Japan.)

* When more than one specification is required, indicate in ascending alphanumeric order.
Note 6) Without a valve function.
Note 7) For thread type NPT.
This product is for overseas use only according to the new Measurement Law. (The SI unit type is provided for use in Japan.)

Filter Regulator AW20(K) to AW40(K) Made to Order Specifications

Contact P/A for detailed dimensions, specifications, and lead times.



③ With Digital Pressure Switch

Digital pressure switch (ISE30-□□-□□-□L) is supplied loose for mounting on pressure gauge connection port.

Specifications

Part number suffix		-X465
Pressure switch	Model	ISE30-□□-□□-□L
	Set pressure range (MPa)	-0.1 to 1
	Set and display resolution (MPa)	0.001
	Power supply voltage	12 to 24 VDC ± 10%, Ripple (p-p) 10% or less (with power supply polarity protection)
	Power consumption	45 mA or less (70 mA or less for current output)

*Pressure gauge port size: 1/8

Applicable models

Model	AW20(K)	AW30(K)	AW40(K)	AW40(K)-06
Port size	1/8, 1/4	1/4, 3/8	1/4, 3/8, 1/2	3/4



How to Order

AW 30 K - F 03 B - 1N - X465 A

Filter regulator

Body size

20	30	40
----	----	----

With back flow mechanism

Nil	—
K	With back flow mechanism

Thread type

Nil	Rc
N Note 1)	NPT
F Note 2)	G



Note 1) Drain guide is NPT1/4 (applicable to AW30 to 40), and the exhaust port for auto drain comes with ø3/8" One-touch fitting (applicable to AW30 to 40).

Note 2) Drain guide is G1/4 (applicable to AW30 to 40).

Port size

Symbol	Port size	Body size		
		20	30	40
01	1/8	●	●	—
02	1/4	●	●	●
03	3/8	—	●	●
04	1/2	—	—	●
06	3/4	—	—	●

Switch specifications

Symbol	Output specifications
A	NPN output
B	PNP output
C	1 to 5V output
D	4 to 20mA output

With digital pressure switch (Series ISE30) Note 7)

Note 7) Optional parts are not assembled and are supplied loose at the time of shipment.

Optional specifications

Symbol	Description	Applicable model
1 Note 4)	0.02 to 0.2MPa setting	AW20(K) to 40(K)
2	Metal bowl	AW20(K) to 40(K)
6	Nylon bowl	AW20(K) to 40(K)
8	Metal bowl with level gauge	AW30(K), 40(K)
C	With bowl guard	AW20(K)
J Note 5)	Drain guide 1/4	AW30(K), 40(K)
N	Non-relieving type	AW20(K) to 40(K)
R	Flow direction: Right to left	AW20(K) to 40(K)
W	Drain cock with barb fitting: ø6 x ø4 nylon tubing	AW30(K), 40(K)
Z Note 6)	Name plate and caution plate for bowl in imperial units (PSI, °F)	AW20(K) to 40(K)



* When more than one specification is required, indicate in ascending alphanumeric order.
Note 4) The only difference from the standard specifications is the adjusting spring for the regulator. It does not restrict the setting of 0.2MPa or more.

Note 5) Without a valve function.

Note 6) For thread type NPT.

This product is for overseas use only according to the new Measurement Law. (The SI unit type is provided for use in Japan.)

Option Note 3)

Symbol	Description	Applicable model
Nil	—	—
B	With bracket	AW20(K) to 40(K)
C	Float type auto drain (N.C.) Note 4)	AW20(K) to 40(K)
D	Float type auto drain (N.O.) Note 4)	AW30(K), 40(K)
H	With set nut (for panel mount)	AW20(K) to 40(K)



Note 3) Optional parts are not assembled and are supplied loose at the time of shipment (except for options C and D)

Note 4) Applicable tube O.D for auto drain connection should be ø3/8" in case NPT thread port is chosen.

Note 8) Consult P/A for detailed dimensions and available attachments and options.

Note 9) Refer to P/A catalog CAT.ES100-42 for detailed specifications and instructions of digital pressure switch.

Filter Regulator with Back Flow Mechanism

AW20K/30K/40K

How to Order



AW40K



AW20K

AW 30 K - F 03 BE - 1N

Filter regulator

Body size

20 30 40

With back flow mechanism

Note) AW10 comes with a back flow mechanism as a standard feature. If the set pressure is not exceeding 0.15MPa, back flow may not occur. When a back flow mechanism is required with a set pressure of less than 0.15MPa, contact P/A.



Thread type

Nil	Rc
N Note 1)	NPT
F Note 2)	G

Note 1) Drain guide is NPT 1/4 (applicable to AW30K and 40K), and the exhaust port for auto drain comes with ø3/8" One-touch fitting (applicable to AW30K and AW40K).

Note 2) Drain guide is G 1/4 (applicable to AW30K and AW40K).

Port size

Symbol	Port size	Body size		
		20	30	40
01	1/8	●	—	—
02	1/4	●	●	●
03	3/8	—	●	●
04	1/2	—	—	●
06	3/4	—	—	●

Optional specifications

Symbol	Description	Applicable model
1 Note 4)	0.02 to 0.2MPa setting	AW20K to 40K
2	Metal bowl	AW20K to 40K
6	Nylon bowl	AW20K to 40K
8	Metal bowl with level gauge	AW30K, 40K
C	With bowl guard	AW20K
J Note 5)	Drain guide 1/4	AW30K, 40K
N	Non-relieving type	AW20K to 40K
R	Flow direction: Right to left	AW20K to 40K
W	Drain cock with barb fitting: ø6 x ø4 nylon tubing	AW30K, 40K
Z Note 6)	Name plate, caution plate for bowl, and pressure gauge in imperial units (PSI, °F)	AW20K to 40K

* When more than one specification is required, indicate in alphanumeric order.
 Note 4) The only difference from the standard specifications is the adjusting spring for the regulator. It does not restrict the setting of 0.2MPa or more.
 Note 5) Without a valve function.
 Note 6) For NPT thread type.
 This product is for overseas use only according to the new Measurement Law. (The SI unit type is provided for use in Japan.)

Accessories Note 3)

Symbol	Description	Applicable model
Nil	—	—
B	With bracket	AW20K to 40K
C	Float type auto drain (N.C.) Note 2)	AW20K to 40K
D	Float type auto drain (N.O.) Note 2)	AW30K, 40K
E	With square embedded type pressure gauge (with limit indicator)	AW20K to 40K
G	With round pressure gauge (with limit indicator)	AW20K to 40K
H	With set nut (for panel mount)	AW20K to 40K

Note 1) Optional parts are not assembled and are supplied loose at the time of shipment (except for options C, D and E).
 Note 2) Applicable tube O.D for auto drain connection should be ø3/8" in case NPT thread port is chosen.

Standard specifications

Model	AW20K	AW30K	AW40K	AW40K-06
Port sizes	1/8, 1/4	1/4, 3/8	1/4, 3/8, 1/2	3/4
Fluid	Air			
Proof pressure	1.5MPa			
Maximum operating pressure	1.0MPa			
Set pressure range Note 1)	0.05 to 0.85MPa			
Pressure gauge port size Note 2)	Rc, NPT, G 1/8	Rc, NPT, G 1/8	Rc, NPT, G 1/4	Rc, NPT, G 1/4
Relief pressure	Set pressure + 0.05MPa [at relief flow rate of 0.1L/min (ANR)]			
Ambient and fluid temperature	-5 to 60°C (with no freezing)			
Nominal filtration rating	5µm			
Drain capacity (cm ³)	8	25	45	45
Bowl material	Polycarbonate			
Bowl guard	Option	Standard		
Construction	Relieving type			
Weight (kg)	0.32	0.40	0.72	0.75

Note 1) Set the inlet pressure 0.05MPa or higher than the set pressure.
 Note 2) Pressure gauge connection threads are not required for regulators with a square embedded type pressure gauge (AW20K to AW40K).

Symbol

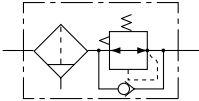

Circuit diagram

When the air supply is cut off and releasing the inlet pressure to the atmosphere, the residual pressure release of the outlet side can be ensured for a safety purpose.

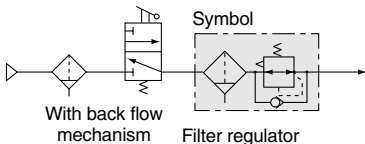

Accessory part no.

Applicable model		AW20K	AW30K	AW40K	AW40K-06
Accessory					
Bracket assembly Note 1)		AW20P-270AS	AR30P-270AS	AR40P-270AS	AR40P-270AS
Set nut		AR20P-260S	AR30P-260S	AR40P-260S	AR40P-260S
Pressure gauge Note 2)	1.0MPa	Round	G36-10-□01	G36-10-□01	G46-10-□02
		Square embedded type Note 3)	GC3-10AS	GC3-10AS	GC3-10AS
	0.2MPa	Round	G36-2-□01	G36-2-□01	G46-2-□02
		Square embedded type Note 3)	GC3-2AS	GC3-2AS	GC3-2AS
Float type auto drain Note 4)	N.O.	—	AD38 AD38N ^{Note 5)}	AD48 AD48N ^{Note 5)}	AD48 AD48N ^{Note 5)}
	N.C.	AD27	AD37 AD37N ^{Note 5)}	AD47 AD47N ^{Note 5)}	AD47 AD47N ^{Note 5)}

Note 1) Assembly includes a bracket and set nuts.
 Note 2) □ in part numbers for a round pressure gauge indicates a type of connection thread. No indication is necessary for R; however, indicate N for NPT. Contact P/A regarding the connection thread NPT and pressure gauge supply for PSI unit specifications.
 Note 3) Includes one O-ring and 2 mounting screws.
 Note 4) Minimum operating pressure: N.O. type-0.1MPa; N.C. type-0.1MPa (AD27) and 0.15MPa (AD37/47). Contact P/A regarding the specifications for PSI unit and "F".
 Note 5) When "N" is specified in the end of part number of auto drain, applicable tube O.D should be ø3/8".

Flow Characteristics (Representative values)

Condition:
Inlet pressure 0.7MPa

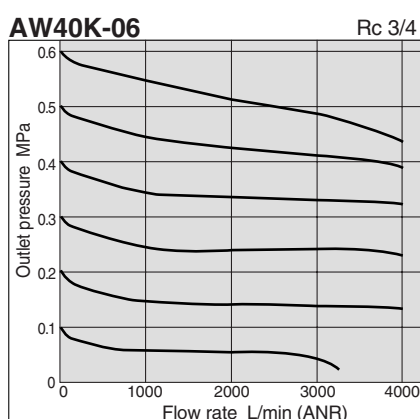
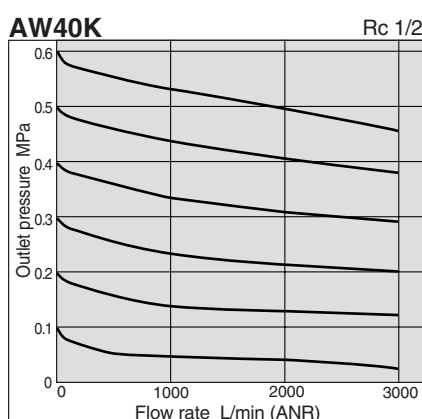
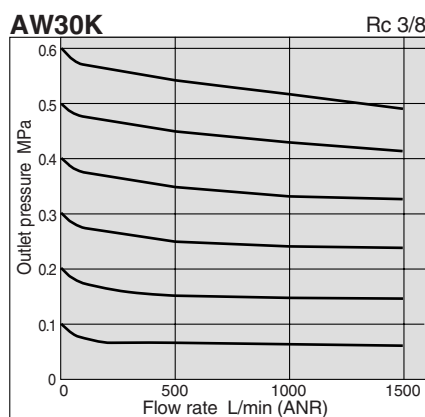
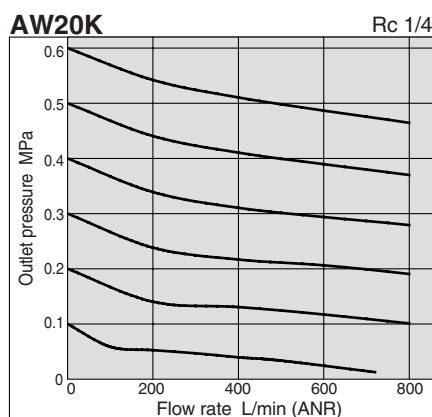

Conditions: Inlet pressure 0.7MPa
Outlet pressure 0.2MPa
Flow rate 20L/min (ANR)

Pressure Characteristics (Representative values)

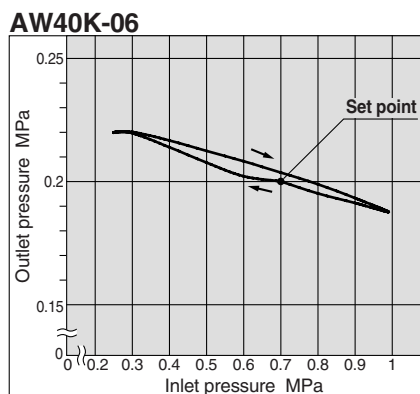
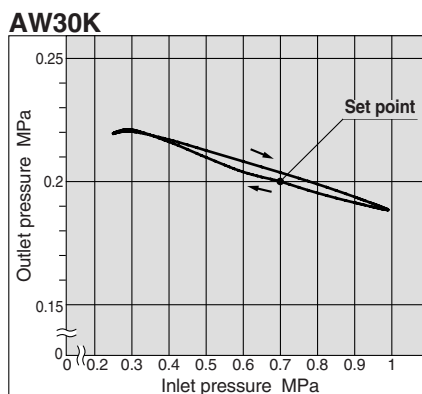
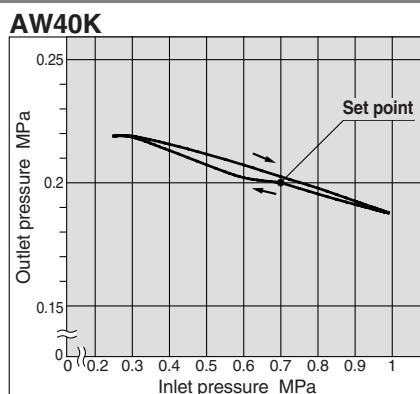
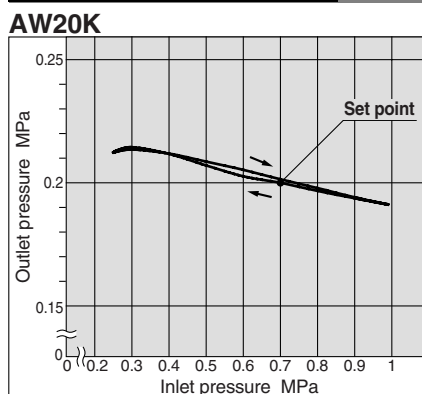

⚠ Specific Product Precautions

Be sure to read before handling.
Refer to pages 75 through 78 for safety instructions and F.R.L. unit precautions.

Mounting & Adjustment

⚠ Warning

1. Set the regulator while checking the displayed values of the inlet and outlet pressure gauges. Turning the knob excessively can cause damage to the internal parts.
2. The pressure gauge included with regulators for 0.02 to 0.2MPa setting is for up to 0.2MPa use. Exceeding 0.2MPa of pressure can damage the gauge.
3. Do not use tools on the pressure regulator knob as this may cause damage. It must be operated manually.

⚠ Caution

1. Be sure to unlock the knob before adjusting the pressure and lock it after setting the pressure.
Failure to follow this procedure can cause damage to the knob and the outlet pressure may fluctuate.
- Pull the pressure regulator knob to unlock. (You can visually verify this with the "orange mark" that appears in the gap.)
 - Push the pressure regulator knob to lock. When the knob is not easily locked, turn it left and right a little and then push it (when the knob is locked, the "orange mark", i.e., the gap will disappear).



2. A knob cover is available to prevent careless operation of the knob. Refer to Features 1 for details.

Maintenance

⚠ Warning

1. Replace the element every 2 years or when the pressure drop becomes 0.1MPa, whichever comes first to prevent damage to the element.

AW20K/30K/40K

Operating Principle

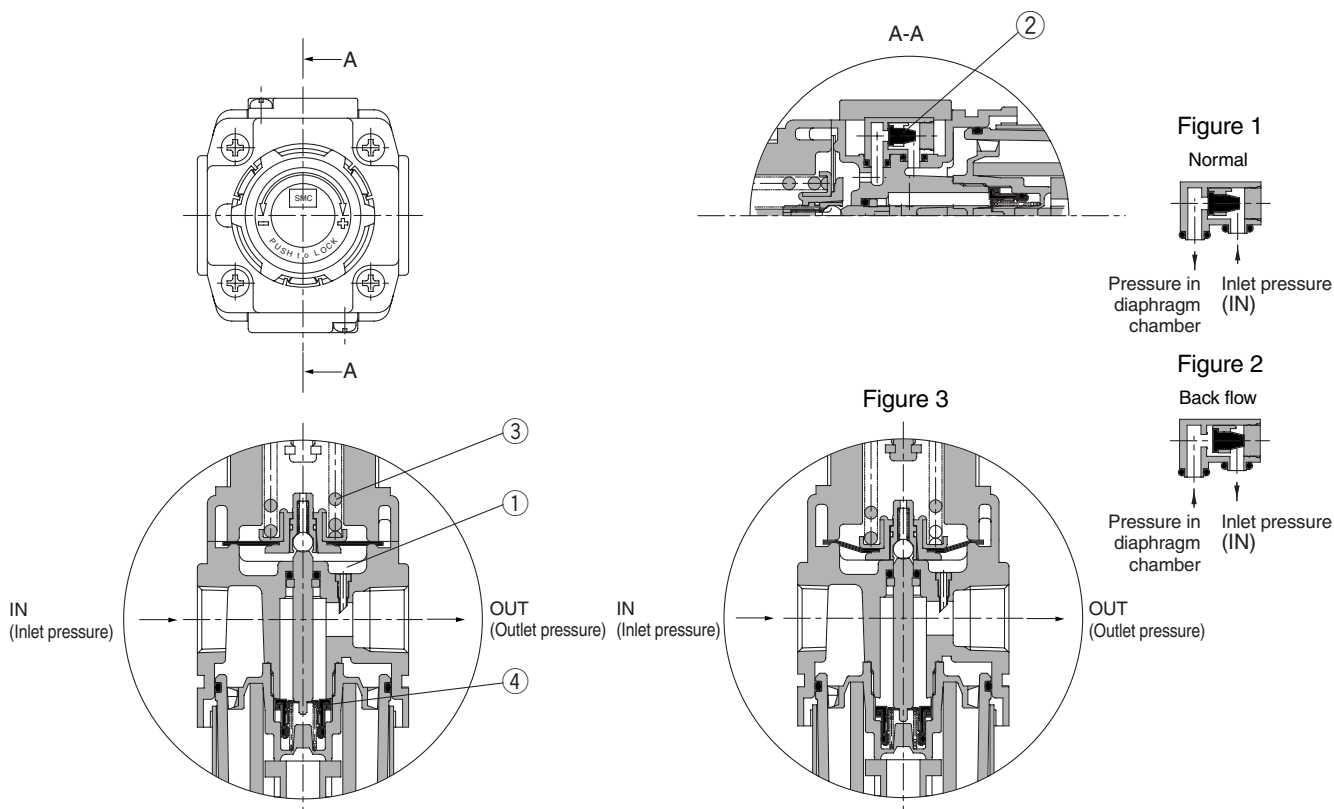

When the inlet pressure (P_1) is higher than the set pressure, the check valve ② closes and operates as a normal regulator (Figure 1).

When the inlet pressure (P_1) is shut off and released, the check valve ②, opens and the pressure in the diaphragm chamber ① is released into the inlet side (Figure 2).

This lowers the pressure in the diaphragm chamber ①, and the force generated by pressure regulator spring ③ lifts the diaphragm. Valve ④ opens through the stem, and the outlet pressure is released to the inlet side (Figure 3).

Construction

AW20K to 40K

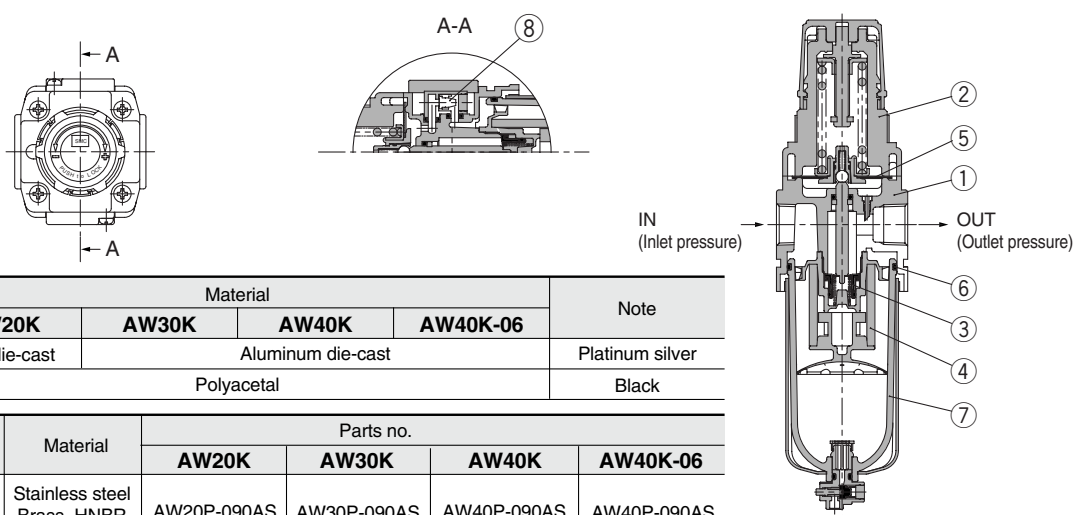

Parts list

No.	Description	Material				Note
		AW20K	AW30K	AW40K	AW40K-06	
1	Body	Zinc die-cast	Aluminum die-cast			Platinum silver
2	Bonnet	Polyacetal				Black
No.	Description	Material	Parts no.			
			AW20K	AW30K	AW40K	AW40K-06
3	Valve assembly	Stainless steel Brass, HNBR	AW20P-090AS	AW30P-090AS	AW40P-090AS	AW40P-090AS
4	Filter element	Non-woven fabric	AF20P-060S	AF30P-060S	AF40P-060S	AF40P-060S
5	Diaphragm assembly	Weatherability NBR	AR20P-150AS	AR30P-150AS	AR40P-150AS	AR40P-150AS
6	Bowl O-ring	NBR	C2SFP-260S	C3SFP-260S	C4SFP-260S	C4SFP-260S
7	Bowl assembly ^{Note 1)}	PC	C2SF	C3SF ^{Note 2)}	C4SF ^{Note 2)}	C4SF ^{Note 2)}
8	Check valve assembly ^{Note 3)}	POM, PBT	AR20KP-020AS	AR20KP-020AS	AR20KP-020AS	AR20KP-020AS

Note 1) Including O-Ring. Contact P/A regarding the bowl assembly supply for PSI and °F unit specifications.

Note 2) Bowl assembly for AW30K to AW60K includes a bowl guard (steel band material).

Note 3) Check valve construction includes the check valve itself, check valve cover, and 2 screws.

Dimensions

AW20K/30K/40K

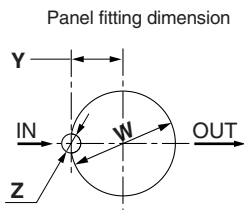
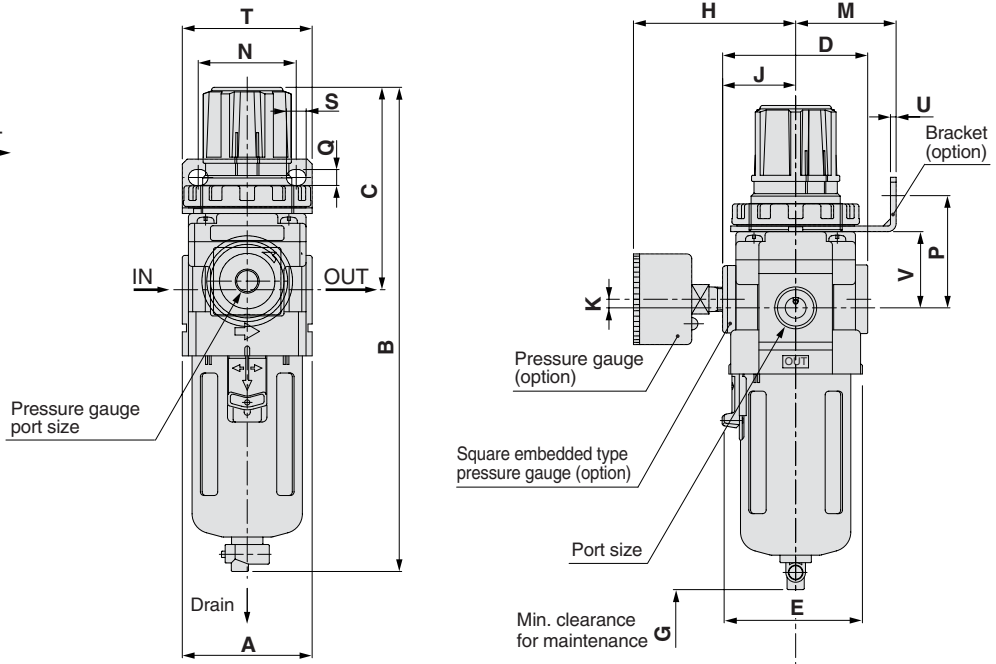

Plate thickness
AW20K, 30K: Max. 3.5
AW40K: Max. 5



Applicable model	AW20K		AW30K, AW40K, AC40K-06				
Optional specifications	With auto drain (N.C.)	Metal bowl	With auto drain (N.O./N.C.)	Metal bowl	Metal bowl with level gauge	With drain guide	Drain cock with barb fitting

Model	Port size	Standard specification						Accessory specification														
		A	B	C	D	E	G	With pressure gauge			Bracket mounting size					Panel mount				With auto drain		
								H	J	K	M	N	P	Q	S	T	U	V	W	Y	Z	B
AW20K	1/8, 1/4	40	160	73	52	40	40	63	27	5	30	34	44	5.4	15.4	55	2.3	30	28.5	14	6	177
AW30K	1/4, 3/8	53	201	86	59	57	55	66	30.5	3.5	41	40	46	6.5	8	53	2.3	31	38.5	19	7	242
AW40K	1/4, 3/8, 1/2	70	239	92	75	73	80	76	38.5	1.5	50	54	54	8.5	10.5	70	2.3	35.5	42.5	21	7	278
AW40K-06	3/4	75	242	93	75	73	80	76	38.5	1.2	50	54	56	8.5	10.5	70	2.3	37	42.5	21	7	278

Model	Port size	Optional specification			
		With barb fitting	With drain guide	Metal bowl	Metal bowl with level gauge
		B	B	B	B
AW20K	1/8, 1/4	—	—	160	—
AW30K	1/4, 3/8	209	208	214	234
AW40K	1/4, 3/8, 1/2	247	246	251	272
AW40K-06	3/4	250	249	255	275

Mist Separator Regulator

AWM20/30/40

Series AWM is a component made up of a regulator and a mist separator that are integrated to provide optimum results in applications such as clean-air blow operations.



AWM20



AWM40

Symbol

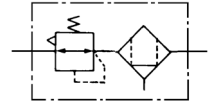

Filtration: 0.3μm

How to Order

AWM 30 — F 03 BE — 1N

Mist separator regulator

Body size
20 30 40

Thread type

Nil	Rc
N Note 1)	NPT
F Note 2)	G



Note 1) Drain guide is NPT1/4 (applicable to AWM30 and 40), and the exhaust port for auto drain comes with ø3/8" One-touch fitting (applicable to AWM30 and AWM40).

Note 2) Drain guide is G1/4 (applicable to AWM30 and AWM40).

Port size

Symbol	Port size	Body size		
		20	30	40
01	1/8	●	—	—
02	1/4	●	●	●
03	3/8	—	●	●
04	1/2	—	—	●

Optional specifications

Symbol	Description	Applicable model
1 Note 4)	0.05 to 0.2MPa setting	AWM20 to 40
2	Metal bowl	AWM20 to 40
6	Nylon bowl	AWM20 to 40
8	Metal bowl with level gauge	AWM30, 40
C	With bowl guard	AWM20
J Note 5)	Drain guide 1/4	AWM30, 40
N	Non-relieving	AWM20 to 40
R	Flow direction: Right to left	AWM20 to 40
W	Drain cock with barb fitting: ø6 x ø4 nylon tubing	AWM30, 40
Z Note 6)	Name plate, caution plate for bowl, and pressure gauge in imperial units (PSI, °F)	AWM20 to 40



* When more than one specification is required, indicate in alphanumeric order.
Note 4) The only difference from the standard specifications is the adjusting spring for the regulator. It does not restrict the setting of 0.2MPa or more.
Note 5) Without a valve function.

Note 6) For NPT thread type.

Note 6) For NPT thread type.
This product is for overseas use only according to the new Measurement Law. (The SI unit type is provided for use in Japan.)

Accessories Note 3)

Symbol	Description	Applicable model
Nil	—	—
B	With bracket	AWM20 to 40
C	Float type auto drain (N.C.) Note 2)	AWM20 to 40
D	Float type auto drain (N.O.) Note 2)	AWM30, 40
E	With square embedded type pressure gauge (with limit indicator)	AWM20 to 40
G	With round pressure gauge (with limit indicator)	AWM20 to 40
H	With set nut (for panel mount)	AWM20 to 40



Note 1) Optional parts are not assembled and are supplied loose at the time of shipment (except for options C, D and E).
Note 2) Applicable tube O.D for auto drain connection should be ø3/8" in case NPT thread port is chosen.

⊙: Combination available

■: Combination not available

○: Varies depending on the model

△: Available only with NPT thread

Accessory/Optional specification combinations

Combination	Symbol	Accessory						Optional specification							Applicable mist separator regulator				
		B	C	D	E	G	H	1	2	6	8	C	J	N	R	W	Z	AWM20	AWM30 to 40
Accessory/Optional specifications																			
Accessories																			
With bracket (with set nut)	B	■	⊙	○	⊙	⊙	■	⊙	⊙	⊙	○	○	⊙	○	△			⊙	⊙
Float type auto drain (N.C.)	C	⊙	■	○	⊙	⊙	⊙	⊙	⊙	○	○	○	○	○	△			⊙	⊙
Float type auto drain (N.O.)	D	⊙	○	○	⊙	⊙	⊙	⊙	⊙	⊙	○	○	○	○	△				⊙
Square embedded type pressure gauge	E	⊙	⊙	⊙	■	■	⊙	⊙	⊙	○	○	○	○	△				⊙	⊙
Round pressure gauge	G	⊙	⊙	○	■	■	⊙	⊙	⊙	○	○	○	○	△				⊙	⊙
With set nut (for panel mount)	H	■	⊙	○	⊙	⊙	■	⊙	⊙	○	○	○	○	△				⊙	⊙
Optional specifications																			
0.05 to 0.2MPa setting	-1	⊙	⊙	○	⊙	⊙	■	⊙	⊙	○	○	○	○	△				⊙	⊙
Metal bowl	-2	⊙	⊙	○	⊙	⊙	⊙	■	■	■	■	○	○	△				⊙	⊙
Nylon bowl	-6	⊙	⊙	○	⊙	⊙	⊙	■	■	■	○	○	○	△				⊙	⊙
Metal bowl with level gauge	-8	⊙	⊙	⊙	⊙	⊙	⊙	■	■	■	○	○	○	△					⊙
With bowl guard	-C	⊙	⊙	■	⊙	⊙	⊙	■	■	■	○	○	○	△				⊙	■
Drain guide 1/4	-J	⊙	■	■	⊙	⊙	⊙	⊙	⊙	⊙	○	○	○	△					⊙
Non-relieving type	-N	⊙	⊙	○	⊙	⊙	⊙	⊙	⊙	○	○	○	○	△				⊙	⊙
Flow direction: Right to left	-R	⊙	⊙	○	⊙	⊙	⊙	⊙	⊙	○	○	○	○	△				⊙	⊙
Drain cock with barb fitting: ø6 x ø4 nylon tubing	-W	⊙	○	○	⊙	⊙	⊙	■	■	■	○	○	○	△					⊙
Name plate, caution plate for bowl, and pressure gauge in imperial units (PSI, °F)	-Z	△	△	△	△	△	△	△	△	△	△	△	△	△				△	△

Standard specifications

Model	AWM20	AWM30	AWM40
Port sizes	1/8, 1/4	1/4, 3/8	1/4, 3/8, 1/2
Fluid	Air		
Proof pressure	1.5MPa		
Maximum operating pressure	1.0MPa		
Set pressure range	0.05 to 0.85MPa		
Pressure gauge port size ^{Note 1)}	Rc, NPT, G 1/8	Rc, NPT, G 1/8	Rc, NPT, G 1/4
Ambient and fluid temperature	-5 to 60°C (with no freezing)		
Nominal filtration rating	0.3µm (95% filtered particle size)		
Outlet side oil mist concentration	Max. 1.0mg/m ³ (ANR) (approx. 0.8ppm) ^{Note 2) Note 3)}		
Rated flow L/min (ANR) ^{Note 4)}	150	330	820
Bowl material	Polycarbonate		
Bowl guard	Option	Standard	
Drain capacity (cm ³)	8	25	45
Construction	Relieving type		
Weight (kg)	0.44	0.59	1.25

Note) When "N" is specified in the end of part number of auto drain, applicable tube O.D should be ø3/8".



Note 1) Pressure gauge connection threads are not required for the regulator with a square embedded type pressure gauge (AWM20 to 40).

Note 2) When the compressor oil mist discharge concentration is 30^{mg}/Nm³ (ANR).

Note 3) Bowl O-ring and other O-rings are slightly lubricated.

Note 4) When the outlet pressure is 0.5MPa. (The rated flow varies depending on the set pressure.)

Keep the air flow within the rated flow to prevent and outflow of a lubricant to the outlet side.

Accessory part no.

Accessory		Applicable model	AWM20	AWM30	AWM40
Bracket assembly ^{Note 1)}			AW20P-270AS	AR30P-270AS	AR40P-270AS
Set nut			AR20P-260S	AR30P-260S	AR40P-260S
Pressure gauge ^{Note 2)}	1.0MPa	Round	G36-10-□01	G36-10-□01	G46-10-□02
		Square embedded type ^{Note 3)}	GC3-10AS	GC3-10AS	GC3-10AS
	0.2MPa	Round	G36-2-□01	G36-2-□01	G46-2-□02
		Square embedded type ^{Note 3)}	GC3-2AS	GC3-2AS	GC3-2AS
Float type auto drain ^{Note 4)}	N.O.	—	AD38	AD38N ^{Note)}	AD48
	N.C.	AD27	AD37	AD37N ^{Note)}	AD47
				AD48N ^{Note)}	AD47N ^{Note)}

Note) When "N" is specified in the end of part number of auto drain, applicable tube O.D should be ø3/8".



Note 1) Assembly includes a bracket and set nuts.

Note 2) □ in part numbers for a round pressure gauge indicates a type of connection thread. No indication is necessary for R; however, indicate N for NPT. Contact P/A regarding the NPT connection thread and pressure gauge supply for PSI unit specifications.

Note 3) Includes one O-ring and 2 mounting screws.

Note 4) Minimum operating pressure: N.O. type-0.1MPa; N.C. type-0.1MPa (AD27) and 0.15MPa (AD37/47). Set the pressure to allow a pressure drop when the fluid flows. Contact P/A regarding the specifications for PSI unit and "F".

⚠ Specific Product Precautions

Be sure to read before handling. Refer to pages 75 through 78 for safety instructions and F.R.L. unit precautions.

Selection

⚠ Warning

- Residual pressure release (outlet pressure release) is not complete by releasing inlet pressure. Contact P/A regarding residual pressure release.

Air Supply

⚠ Caution

- Install an air filter (Series AF) as a preliminary filter on the inlet side of the mist separator regulator to prevent premature clogging.

Maintenance

⚠ Warning

- Replace the element every 2 years or when the pressure drop becomes 0.1MPa, whichever comes first, to prevent damage to the element.

Mounting & Adjustment

⚠ Warning

- Set the regulator while checking the displayed values of the inlet and outlet pressure gauges. Turning the knob excessively can cause damage to the internal parts.
- The pressure gauge included with mist separator regulators for 0.05 to 0.2MPa setting is for up to 0.2MPa only. Exceeding 0.2MPa of pressure can damage the gauge.
- Do not use tools on the pressure regulator knob as this may cause damage. It must be operated manually.

⚠ Caution

- Be sure to unlock the knob before adjusting the pressure and lock it after setting the pressure. Failure to follow this procedure can cause damage to the knob and the outlet pressure may fluctuate.

- Pull the pressure regulator knob to unlock. (You can visually verify this with the "orange mark" that appears in the gap.)
- Push the pressure regulator knob to lock. When the knob is not easily locked, turn it left and right a little and then push it (when the knob is locked, the "orange mark" i.e., the gap, will disappear).



- A knob cover is available to prevent careless operation of the knob. Refer to Features 1 for details.

AWM20/30/40

Flow Characteristics (Representative values)

Condition: Inlet pressure 0.7MPa

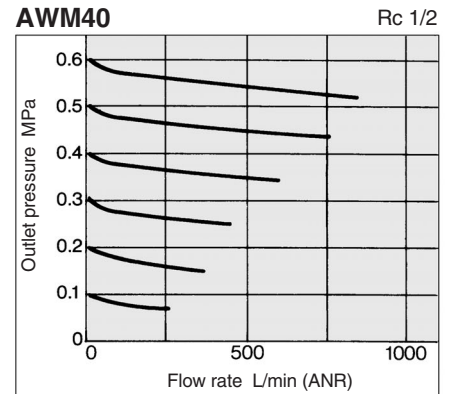
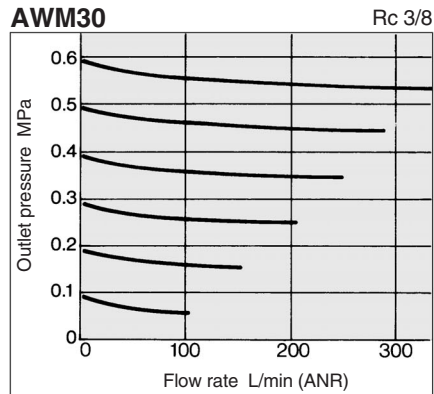
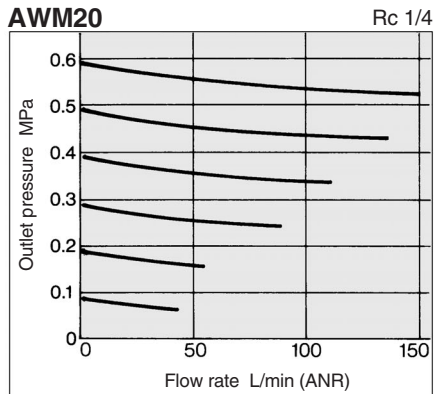

Pressure Characteristics

Conditions: Inlet pressure 0.7MPa; Outlet pressure 0.2MPa; Flow rate: 20L/min (ANR)

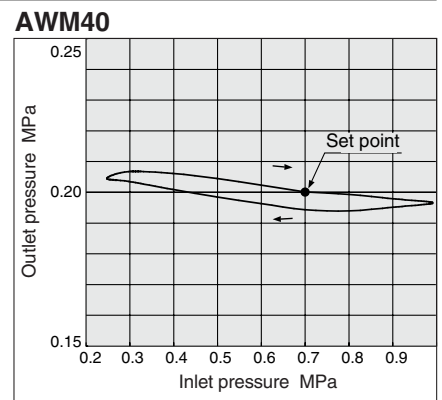
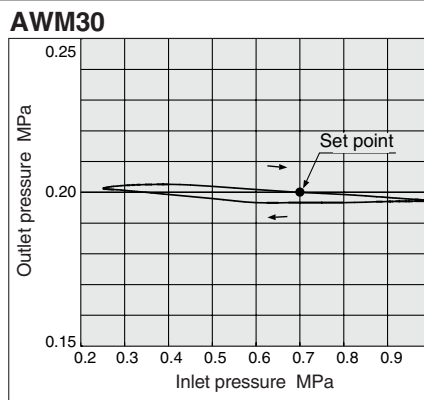
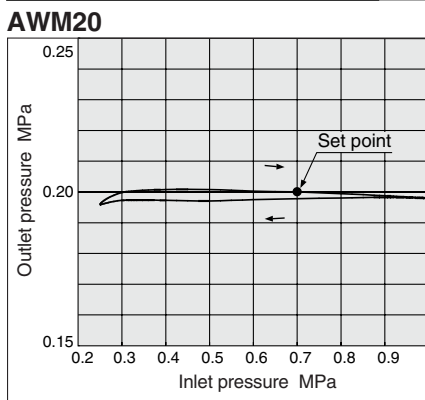

Construction

JIS symbol

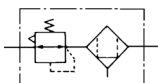

AWM20

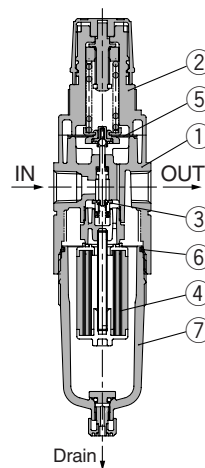

AWM30, 40

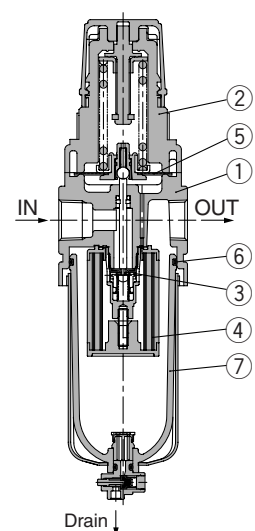

Parts list

No.	Description	Material			Note
		AWM20	AWM30	AWM40	
1	Body	Zinc die-cast	Aluminum die-cast		Platinum silver
2	Bonnet		Polyacetal		Black

Replacement parts

No.	Description	Material	Part no.		
			AWM20	AWM30	AWM40
3	Valve assembly	Brass, HNBR	AWM20P-090AS	AWM30P-090AS	AWM40P-090AS
4	Element assembly	—	AFM20P-060AS	AFM30P-060AS	AF40P-060AS
5	Diaphragm assembly	Weatherability NBR	AR20P-150AS	AR30P-150AS	AR40P-150AS
6	Bowl O-ring	NBR	C2SFP-260S	C3SFP-260S	C4SFP-260S
7	Bowl assembly ^{Note 1)}	PC	C2SF	C3SF ^{Note 2)}	C4SF ^{Note 2)}



Note 1) Including O-Ring. Contact P/A regarding the bowl assembly supply for PSI and °F unit specifications.
 Note 2) Bowl assembly for AWM30 and AWM40 comes with a bowl guard (steel band material).

Mist Separator Regulator **AWM20/30/40**

Dimensions

AWM20

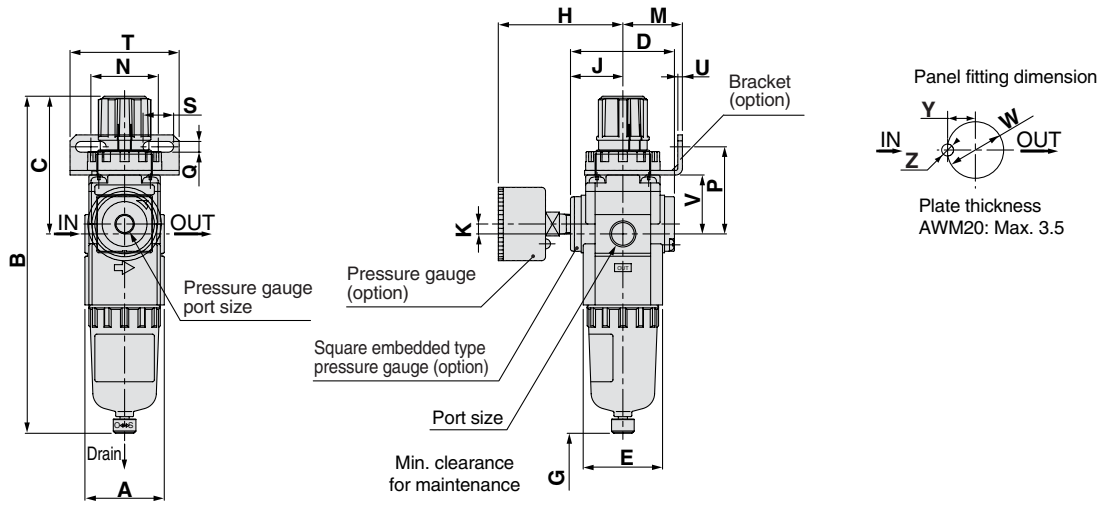

AWM30, 40

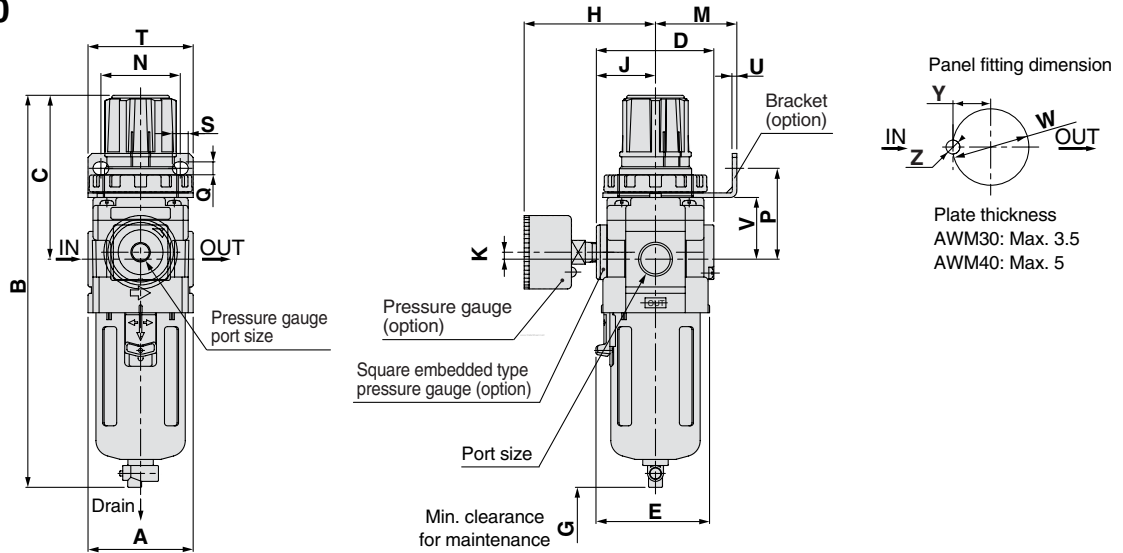

Applicable model	AWM20		AWM30, AWM40				
Optional specifications	With auto drain (N.C.)	Metal bowl	With auto drain (N.O./N.C.)	Metal bowl	Metal bowl with level gauge	With drain guide	Drain cock with barb fitting

Model	Port size	Standard specification						Accessory specification														
		A	B	C	D	E	G	With pressure gauge			Bracket mounting size					Panel mount					With auto drain	
		A	B	C	D	E	G	H	J	K	M	N	P	Q	S	T	U	V	W	Y	Z	B
AWM20	1/8, 1/4	40	173	73	52	40	45	63	27	5	30	34	44	5.4	15.4	55	2.3	30	28.5	14	6	190
AWM30	1/4, 3/8	53	201	86	59	57	50	66	30.5	3.5	41	40	46	6.5	8	53	2.3	31	38.5	19	7	242
AWM40	1/4, 3/8, 1/2	70	239	92	75	73	70	76	38.5	1.5	50	54	54	8.5	10.5	70	2.3	35.5	42.5	21	7	278

Model	Optional specification				
	With barb fitting	With drain guide	Metal bowl	Metal bowl with level gauge	
		B	B	B	B
AWM20	—	—	173	—	
AWM30	209	208	214	234	
AWM40	247	246	252	272	

Micro-Mist Separator Regulator AWD20/30/40

Series AWD is a component made up of a regulator and a micro-mist separator that are integrated to provide optimum results in applications such as ultraclean air blow operations.

Filtration: 0.01µm



AWD20



AWD40

Symbol

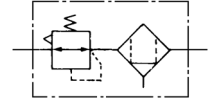

How to Order

AWD 30 — **F** **03** **BE** — **1N**

Micro-mist separator regulator

Body size

20 30 40

Thread type

Nil	Rc
N Note 1)	NPT
F Note 2)	G

Note 1) Drain guide is for NPT1/4 (applicable to AWD30 and AWD40), and the exhaust port for auto drain comes with ø3/8" One-touch fitting (applicable to AWD30 and AWD40).

Note 2) Drain guide is G1/4 (applicable to AWD30 and AWD40).

Port size

Symbol	Port size	Body size		
		20	30	40
01	1/8	●	—	—
02	1/4	●	●	●
03	3/8	—	●	●
04	2/1	—	—	●

Optional specifications

Symbol	Description	Applicable model
1 Note 4)	0.05 to 0.2MPa setting	AWD20 to 40
2	Metal bowl	AWD20 to 40
6	Nylon bowl	AWD20 to 40
8	Metal bowl with level gauge	AWD30, 40
C	With bowl guard	AWD20
J Note 5)	Drain guide 1/4	AWD30, 40
N	Non-relieving	AWD20 to 40
R	Flow direction: Right to left	AWD20 to 40
W	Drain cock with barb fitting: ø6 x ø4 nylon tubing	AWD30, 40
Z Note 6)	Name plate, caution plate for bowl, and pressure gauge in imperial units (PSI, °F)	AWD20 to 40

* When more than one specification is required, indicate in alphanumeric order.

Note 4) The only difference from the standard specifications is the adjusting spring for the regulator. It does not restrict the setting of 0.2MPa or more.

Note 5) Without a valve function.

Note 6) For NPT thread type.

This product is for overseas use only according to the new Measurement Law. (The SI unit type is provided for use in Japan.)

Accessories Note 3)

Symbol	Description	Applicable model
Nil	—	—
B	With bracket	AWD20 to 40
C	Float type auto drain (N.C.) Note 4)	AWD20 to 40
D	Float type auto drain (N.O.) Note 4)	AWD30, 40
E	With square embedded type pressure gauge (with limit indicator)	AWD20 to 40
G	With round pressure gauge (with limit indicator)	AWD20 to 40
H	With set nut (for panel mount)	AWD20 to 40

Note 3) Optional parts are not assembled and are supplied loose at the time of shipment (except for options C, D and E).
Note 4) Applicable tube O.D for auto drain connection should be ø3/8" in case NPT thread port is chosen.

⊙: Combination available

■: Combination not available

○: Varies depending on the model

△: Available only with NPT thread

Accessory/Optional specification combinations

Combination	Symbol	Accessory											Optional specification								Applicable micro-mist separator regulator	
		B	C	D	E	G	H	1	2	6	8	C	J	N	R	W	Z	AWD20	AWD30 to 40			
Accessories																						
With bracket (with set nut)	B	⊙	○	○	○	○	○	○	○	○	○	○	○	○	○	○	○	△	○	○		
Float type auto drain (N.C.)	C	⊙	○	○	○	○	○	○	○	○	○	○	○	○	○	○	○	△	○	○		
Float type auto drain (N.O.)	D	⊙	○	○	○	○	○	○	○	○	○	○	○	○	○	○	○	△	○	○		
Square embedded type pressure gauge	E	⊙	○	○	○	○	○	○	○	○	○	○	○	○	○	○	○	△	○	○		
Round pressure gauge	G	⊙	○	○	○	○	○	○	○	○	○	○	○	○	○	○	○	△	○	○		
Panel mount (with set nut)	H	⊙	○	○	○	○	○	○	○	○	○	○	○	○	○	○	○	△	○	○		
Optional specifications																						
0.05 to 0.2MPa setting	-1	⊙	○	○	○	○	○	○	○	○	○	○	○	○	○	○	○	△	○	○		
Metal bowl	-2	⊙	○	○	○	○	○	○	○	○	○	○	○	○	○	○	○	△	○	○		
Nylon bowl	-6	⊙	○	○	○	○	○	○	○	○	○	○	○	○	○	○	○	△	○	○		
Metal bowl with level gauge	-8	⊙	○	○	○	○	○	○	○	○	○	○	○	○	○	○	○	△	○	○		
With bowl guard	-C	⊙	○	○	○	○	○	○	○	○	○	○	○	○	○	○	○	△	○	○		
Drain guide 1/4	-J	⊙	○	○	○	○	○	○	○	○	○	○	○	○	○	○	○	△	○	○		
Non-relieving type	-N	⊙	○	○	○	○	○	○	○	○	○	○	○	○	○	○	○	△	○	○		
Flow direction: Right to left	-R	⊙	○	○	○	○	○	○	○	○	○	○	○	○	○	○	○	△	○	○		
Drain cock with barb fitting: ø6 x ø4 nylon tubing	-W	⊙	○	○	○	○	○	○	○	○	○	○	○	○	○	○	○	△	○	○		
Name plate, caution plate for bowl, and pressure gauge in imperial units (PSI, °F)	-Z	△	△	△	△	△	△	△	△	△	△	△	△	△	△	△	△	△	△	△		

Standard specifications

Model	AWD20	AWD30	AWD40
Port sizes	1/8, 1/4	1/4, 3/8	1/4, 3/8, 1/2
Fluid	Air		
Proof pressure	1.5MPa		
Maximum operating pressure	1.0MPa		
Set pressure range	0.05 to 0.85MPa		
Pressure gauge port size ^{Note 1)}	Rc, NPT, G 1/8	Rc, NPT, G 1/8	Rc, NPT, G 1/4
Ambient and fluid temperature	-5 to 60°C (with no freezing)		
Nominal filtration rating	0.01µm (95% filtered particle size)		
Outlet side oil mist concentration	Max. 0.1mg/m ³ (ANR) ^{Note 2) Note 3)} (before saturated with hydraulic fluid: 0.01mg/m ³ (ANR) or less, approx. 0.008ppm)		
Rated flow L/min (ANR) ^{Note 4)}	90	180	450
Bowl material	Polycarbonate		
Bowl guard	Option	Standard	
Drain capacity (cm ³)	8	25	45
Construction	Relieving type		
Weight (kg)	0.44	0.59	1.25



Note 1) Pressure gauge connection threads are not required for the regulator with a square embedded type pressure gauge (AWD20 to 40).

Note 2) When the compressor oil mist discharge concentration is 30mg/m³ (ANR).

Note 3) Bowl O-ring and other O-rings are slightly lubricated.

Note 4) When the outlet pressure is 0.5MPa. (The rated flow varies depending on the set pressure.)
Keep the air flow within the rated flow to prevent an outflow of lubricant to the outlet side.

Accessory part no.

Applicable model		AWD20	AWD30	AWD40	
Accessory					
Bracket assembly ^{Note 1)}		AW20P-270AS	AR30P-270AS	AR40P-270AS	
Set nut		AR20P-260S	AR30P-260S	AR40P-260S	
Pressure gauge ^{Note 2)}	1.0MPa	Round	G36-10-□01	G36-10-□01	G46-10-□02
		Square embedded type ^{Note 3)}	GC3-10AS	GC3-10AS	GC3-10AS
	0.2MPa	Round	G36-2-□01	G36-2-□01	G46-2-□02
		Square embedded type ^{Note 3)}	GC3-2AS	GC3-2AS	GC3-2AS
Float type auto drain ^{Note 4)}	N.O.	—	AD38 AD38N ^{Note 5)}	AD48 AD48N ^{Note 5)}	
	N.C.	AD27	AD37 AD37N ^{Note 5)}	AD47 AD47N ^{Note 5)}	



Note 1) Assembly includes a bracket and set nuts.

Note 2) □ in part numbers for a round pressure gauge indicates a type of connection thread. No indication is necessary for R; however, indicate N for NPT. Contact P/A regarding the NPT connection thread and pressure gauge supply for PSI unit specifications.

Note 3) Includes one O-ring and 2 mounting screws.

Note 4) Minimum operating pressure: N.O. type-0.1MPa; N.C. type-0.1MPa (AD27) and 0.15MPa (AD37/47). Set the pressure to allow a pressure drop when the fluid flows. Contact P/A regarding the specifications for PSI unit and "F".

Note 5) When "N" is specified in the end of part number of auto drain, applicable tube O.D should be ø3/8".

⚠ Specific Product Precautions

Be sure to read before handling. Refer to pages 75 through 78 for safety instructions, F.R.L. unit precautions.

Selection

⚠ Warning

- Residual pressure release (outlet pressure release) is not complete by releasing inlet pressure. Contact P/A regarding the residual pressure release.

Air Supply

⚠ Caution

- Install an air filter (Series AFM) as a preliminary filter on the inlet side of the micro-mist separator to prevent premature clogging.

Maintenance

⚠ Warning

- Replace the element every 2 years or when the pressure drop becomes 0.1MPa, whichever comes first, to prevent damage to the element.

Mounting & Adjustment

⚠ Warning

- Set the regulator while checking the displayed values of the inlet and outlet pressure gauges. Turning the knob excessively can cause damage to the internal parts.
- The pressure gauge included with micro-mist separator regulator for 0.05 to 0.2MPa setting is for up to 0.2MPa only. Exceeding 0.2MPa of pressure can damage the gauge.
- Do not use tools on the pressure regulator knob as this may cause damage. It must be operated manually.

⚠ Caution

- Be sure to unlock the knob before adjusting the pressure and lock it after setting the pressure.
Failure to follow this procedure can cause damage to the knob and the outlet pressure may fluctuate.

- Pull the pressure regulator knob to unlock. (You can visually verify this with the "orange mark" that appears in the gap.)
- Push the pressure regulator knob to lock. When the knob is not easily locked, turn it left and right a little and then push it (when the knob is locked, the "orange mark" will disappear).



- A knob cover is available to prevent careless operation of the knob. Refer to Features 1 for details.

AWD20/30/40

Flow Characteristics (Representative value)

Condition: Inlet pressure 0.7MPa

AWD20 Rc 1/4

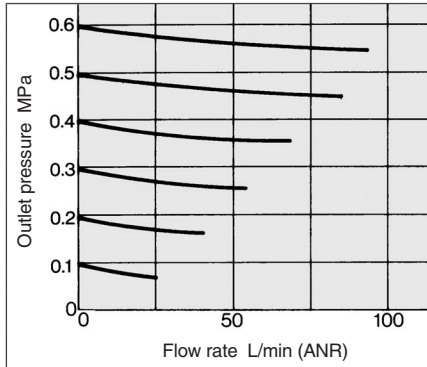

AWD30 Rc 3/8

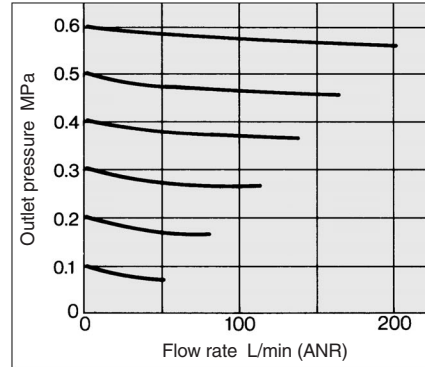

AWD40 Rc 1/2

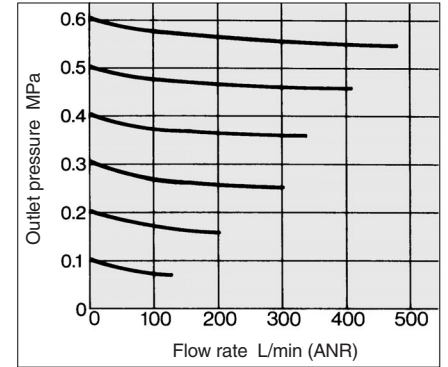

Pressure Characteristics (Representative value)

Conditions: Inlet pressure 0.7MPa; Outlet pressure 0.2MPa; Flow rate: 20L/min (ANR)

AWD20

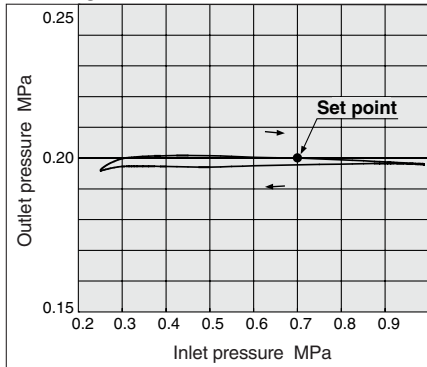

AWD30

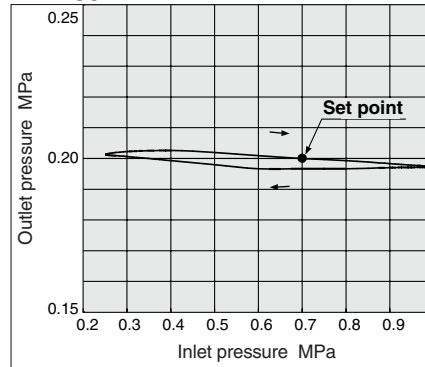

AWD40

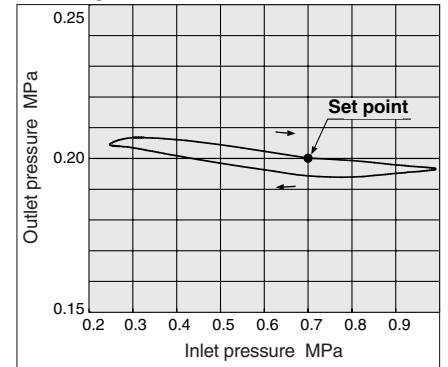

Construction

JIS symbol

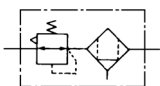

AWD20

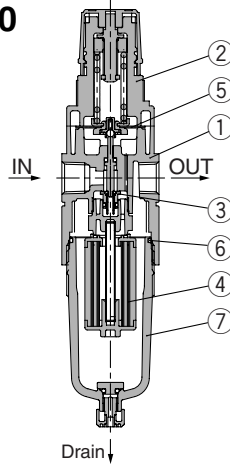

AWD30, 40

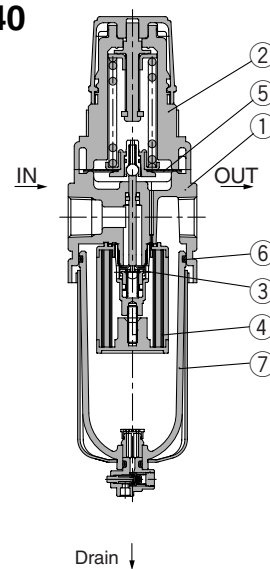

Parts list

No.	Description	Material			Note
		AWD20	AWD30	AWD40	
1	Body	Zinc die-cast	Aluminum die-cast		Platinum silver
2	Bonnet	Polyacetal			Black

Replacement parts

No.	Description	Materials	Parts no.		
			AWD20	AWD30	AWD40
3	Valve assembly	Brass, HNBR	AWM20P-090AS	AWM30P-090AS	AWM40P-090AS
4	Element assembly	—	AFD20P-060AS	AFD30P-060AS	AFD40P-060AS
5	Diaphragm assembly	Weatherability NBR	AR20P-150AS	AR30P-150AS	AR40P-150AS
6	Bowl O-ring	NBR	C2SFP-260S	C3SFP-260S	C4SFP-260S
7	Bowl assembly <small>Note 1)</small>	PC	C2SF	C3SF <small>Note 2)</small>	C4SF <small>Note 2)</small>

 Note 1) Including O-Ring. Contact P/A regarding the bowl assembly supply for PSI and °F unit specifications.
 Note 2) Bowl assembly for AWD30 and AWD40 comes with a bowl guard (steel band material).

Dimensions

AWD20

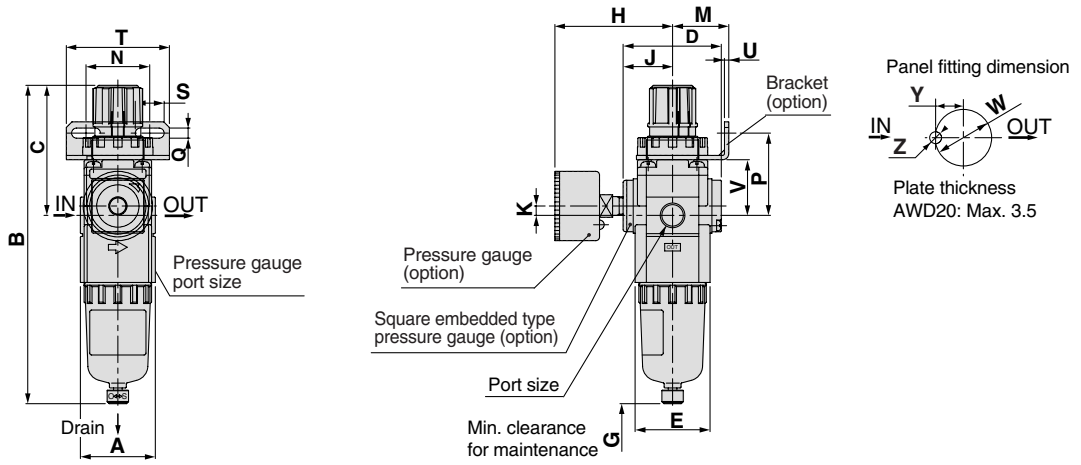

AWD30, 40

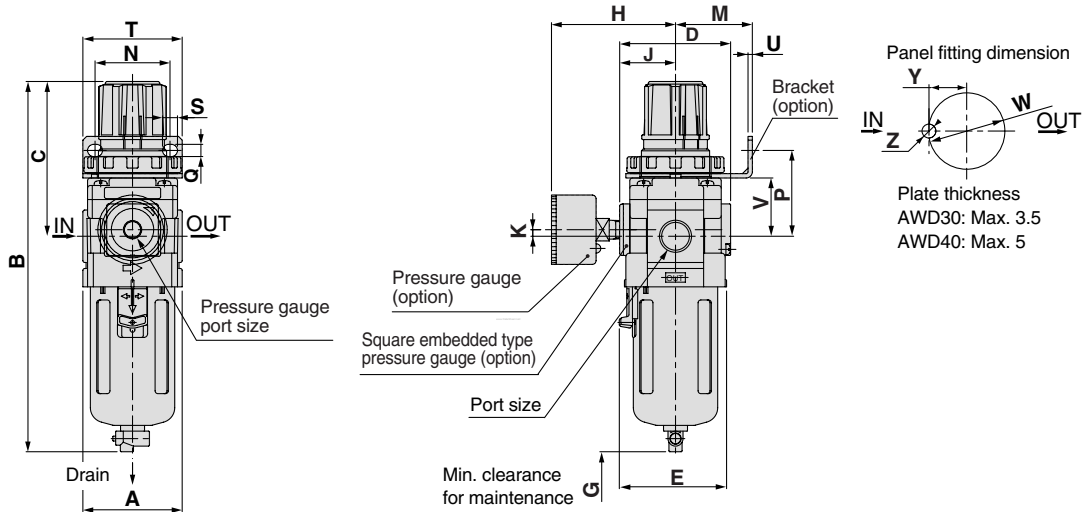

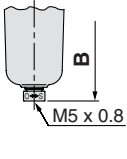
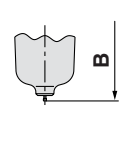
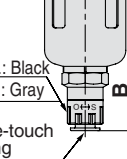
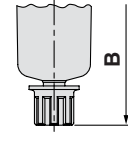
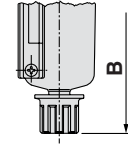
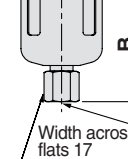
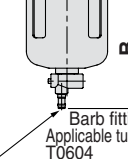
Applicable model	AFD20		AWD30, AWD40				
	With auto drain (N.C.)	Metal bowl	With auto drain (N.O./N.C.)	Metal bowl	Metal bowl with level gauge	With drain guide	Drain cock with barb fitting
Optional specifications	 M5 x 0.8		 N.O.: Black N.C.: Gray ø10 One-touch fitting			 Width across flats 17	 Barb fitting Applicable tubing: T0604

Model	Port size	Standard specification						Accessory specification														
		A	B	C	D	E	G	With pressure gauge			Bracket mounting size						Panel mount				With auto drain	
								H	J	K	M	N	P	Q	S	T	U	V	W	Y	Z	B
AWD20	1/8, 1/4	40	173	73	52	40	45	63	27	5	30	34	44	5.4	15.4	55	2.3	30	28.5	14	6	190
AWD30	1/4, 3/8	53	201	86	59	57	50	66	30.5	3.5	41	40	46	6.5	8	53	2.3	31	38.5	19	7	242
AWD40	1/4, 3/8, 1/2	70	239	92	75	73	70	76	38.5	1.5	50	54	54	8.5	10.5	70	2.3	35.5	42.5	21	7	278

Model	Optional specification			
	With barb fitting	With drain guide	Metal bowl	Metal bowl with level gauge
	B	B	B	B
AWD20	—	—	173	—
AWD30	209	208	214	234
AWD40	247	246	252	272