

高效率、双路独立 1.5A、支持双色温 LED 闪光灯驱动器

特性

- 支持闪光灯和指示灯二合一应用
- 支持双色温 LED 闪光灯
- 双路独立可编程 1.5A LED 驱动:
 - Flash: 11.35mA~1.5A, 128 levels
11.72mA/level
 - Torch: 2.55mA~372mA, 128 levels
2.91mA/level
 - Indicator: 0.02mA~372mA, 128*128 levels
0.02mA/level
 - Flash Timeout: 40ms~1.6s, 16 levels
 - Flash/Torch/Indicator/IR 模式
- 效率高达 85%
- 低电池电压监控保护 (IVFM)
- 硬件 Flash 使能 (STROBE)
- 硬件 Torch 使能 (TORCH/TEMP)
- 远程 NTC 监控
- 射频功率放大器脉冲事件的 TX 同步输入
- 400kHz I²C: AW36414 (I²C 地址=0x6B)
- 0.4mm Pitch, CSP-12 封装
与 AW3643, AW3644, AW36413 管脚兼容

应用

手机闪光灯

典型应用图



图 1 AW36414 典型应用图

手册中提到的全部商标所有权归各自拥有者所有。

概要

AW36414 是一款双通道高精度 LED 闪光灯驱动器，能够以较小的 PCB 面积提供高度可调节的闪光解决方案。AW36414 内置 2MHz/4MHz 固定频率同步升压转换器为两路 1.5A 恒流 LED 供电。两路 LED 电流源可独立控制，且均支持 128 级电流配置。AW36414 提供三种低电池电压保护模式，防止低电池电压情况下的系统关断或复位。AW36414 内置自适应的高精度电流源调节机制，同时最大限度地提高效率。

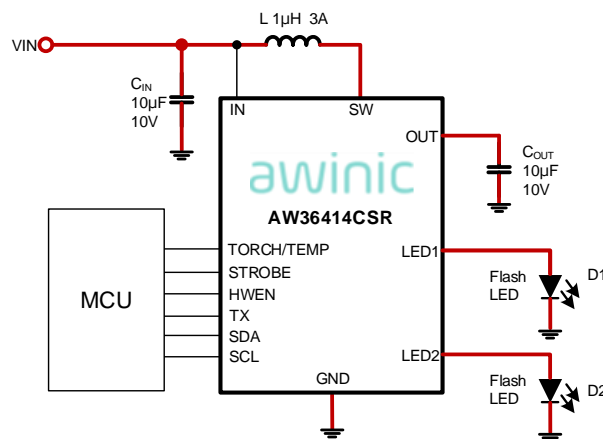
AW36414 可通过 I²C 接口灵活配置 Flash/Torch 电流、闪光保护时间、IVFM、TX 中断及 NTC 监控功能。同时 AW36414 也可通过硬件 STORBE、TORCH/TEMP 完成 Flash 和 Torch 过程。

AW36414 提供 2MHz/4MHz 开关频率选项、过压保护(OVP)功能以及可调电感限流功能，允许使用微型、超薄的电感器和 10µF 陶瓷电容。AW36414 工作环境温度范围为 -40°C 至 85°C。

AW36414 采用 0.4mm Pitch, CSP-12 封装，封装大小为 1.626mm×1.332mm。

High Efficiency, Dual Independent 1.5A Flash LED Driver

FEATURES

- Support Flash and Indicator 2in1 application
- Support Dual Color Temperature Flash LED Application
- Dual Independent and Programmable 1.5A LED Current Source
 - Flash: 11.35mA~1.5A, 128 levels
11.72mA/level
 - Torch: 2.55mA~372mA, 128 levels
2.91mA/level
 - Indicator: 0.02mA~372mA, 128*128 levels
0.02mA/level
 - Flash Timeout: 40ms~1.6s, 16 levels
 - Flash/Torch/Indicator/IR Mode
- High Efficiency: 85%
- Optimized Flash LED Current During Low Battery Conditions (IVFM)
- Hardware Strobe Enable (STROBE)
- Hardware Torch Enable (TORCH/TEMP)
- Remote NTC Monitoring
- Synchronization Input for RF Power Amplifier Pulse Events (TX)
- 400kHz I²C: AW36414 (I²C Address=0x6B)
- 0.4mm Pitch, CSP-12 Package
Compatible with AW3643, AW3644, AW36413

APPLICATION

Smartphone Camera Flash

TYPICAL APPLICATION CIRCUIT

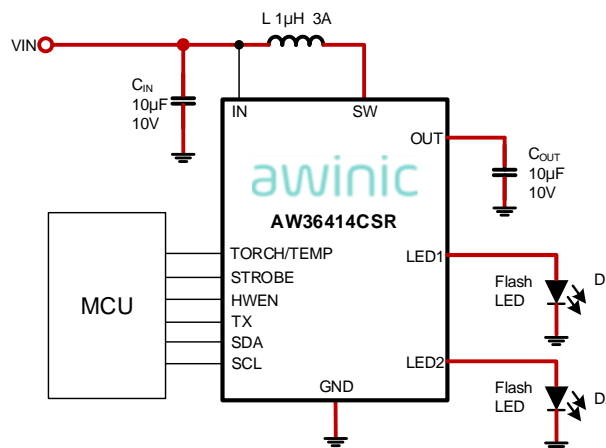

Fig 1 Typical Application Circuit of AW36414

GENERAL DESCRIPTION

The AW36414 is a dual LED flash driver that provides a high level of adjustability within a small solution size. The AW36414 utilizes a 2MHz or 4MHz fixed-frequency synchronous boost converter to provide power to the dual 1.5A constant current LED sources. The dual 128 levels current sources provide the flexibility to adjust the current of LED1 and LED2 in Flash/Torch/IR modes. The AW36414 provides three IVFM protection modes to prevent system reset or shutdown under low battery condition.

The AW36414 are controlled via an I²C - compatible interface. The main features of the AW36414 include: flash/torch current, flash timeout duration, IVFM, TX interrupt, and NTC thermistor monitor. The AW36414 also provides hardware flash and hardware torch pins (STROBE and TORCH/TEMP) to control Flash/Torch events.

The 2MHz or 4MHz switching frequency options, overvoltage protection (OVP), and adjustable current limit allow for the use of tiny, low-profile inductors and 10-µF ceramic capacitors. The device operates over a -40°C to +85°C ambient temperature range.

The AW36414 is available in small 0.4mm pitch 1.626mm×1.332mm CSP-12 package.

PIN CONFIGURATION AND TOP MARK

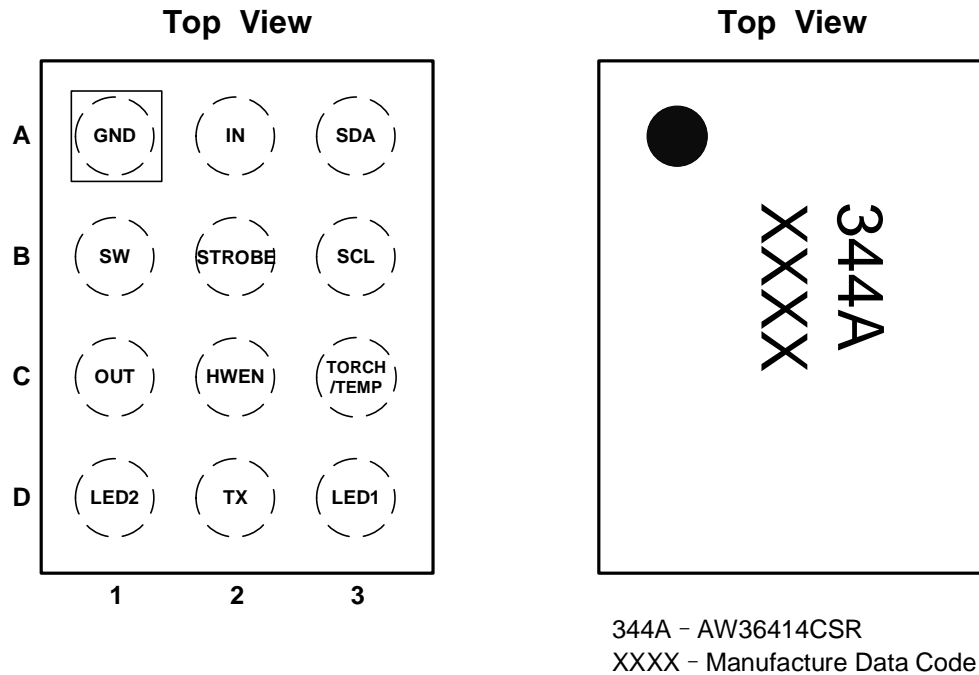

Fig 2 Pin Configuration and Top Mark

PIN DEFINITION

No.	NAME	TYPE	DESCRIPTION
A1	GND	Ground	Ground
A2	IN	Power	Input voltage connection. Connect IN to GND with a 10μF or larger ceramic capacitor.
A3	SDA	I/O	Serial data input/output of the I ² C interface.
B1	SW	Power	Switch pin of the step-up DC-DC convertor.
B2	STROBE	I/O	Active high hardware flash enable. Drive STROBE high to turn on Flash pulse. Internal pull down resistor of 300kΩ between STROBE and GND.
B3	SCL	I/O	Serial clock input of the I ² C interface.
C1	OUT	Power	Step-up DC-DC converter output. Connect a 10μF ceramic capacitor between OUT and GND.
C2	HWEN	I/O	Active high enable pin. High = Standby, Low = Shutdown/Reset. Internal pull down resistor of 300kΩ between HWEN and GND.
C3	TORCH/TEMP	I/O	Torch terminal input or threshold detector for NTC temperature sensing and current scale back.
D1	LED2	Power	High-side current source output for flash LED2.
D2	TX	I/O	Power amplifier synchronization input. Internal pull down resistor of 300kΩ between TX and GND.
D3	LED1	Power	High-side current source output for flash LED1.

ORDERING INFORMATION

Part Number	Op Temp	Package	Marking	Delivery Form
AW36414CSR	-40°C ~ 85°C	1.626mm×1.332mm-12pin	344A	3000 units/ Tape and Reel

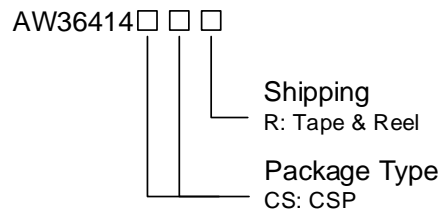

AWINIC FLASH LED DRIVER SERIES

Product	Channels	Type	Description	Package
AW3644	2	Boost	High Efficiency, Dual Independent 1.5A Flash LED Driver	CSP-12
AW36414	2	Boost	High Efficiency, Dual Independent 1.5A Flash LED Driver	CSP-12
AW3643	2	Boost	High Efficiency, Dual 1.5A Flash LED Driver	CSP-12
AW36413	2	Boost	High Efficiency, Dual 1.5A Flash LED Driver	CSP-12
AW3648	1	Boost	High Efficiency, 1.5A Flash LED Driver	CSP-12
AW3641E	1	Charge Pump	Flash Current & Flash Timer Programmable 1A Flash LED Driver	DFN-10L
AW3640	1	Current Sink	200mA 1-Wire Configurable Front Flash LED Driver with Ultra Small Package	DFN-6L

TYPICAL APPLICATION CIRCUITS

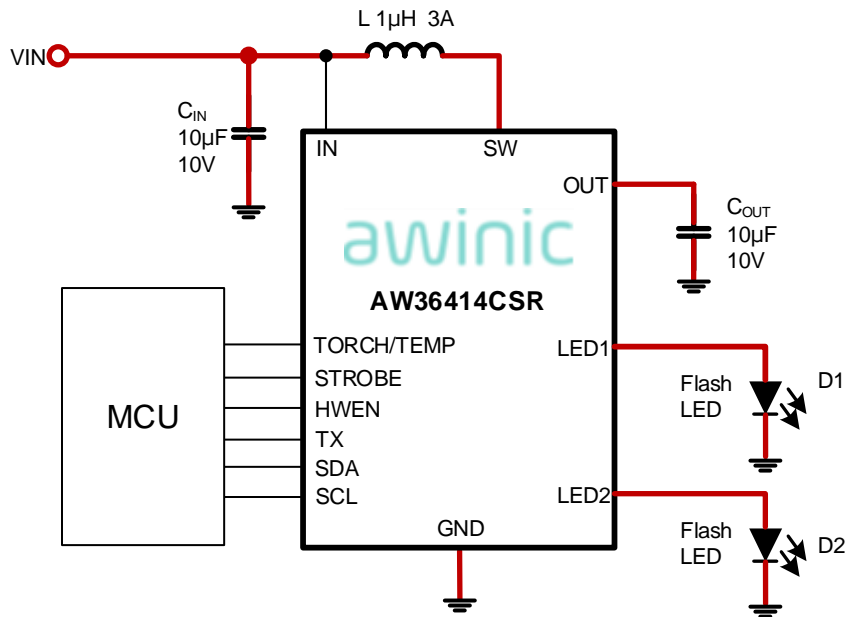

Fig 3 AW36414 Application Circuit

Notice for Typical Application Circuits:

- 1: Please place C_{IN}, C_{OUT} as close to the chip as possible.
- 2: Connect the inductor on the top layer close to the SW pin.
- 3: For the sake of driving capability, the power lines, output lines, and the connection lines of L and LED should be short and wide as possible.

ABSOLUTE MAXIMUM RATINGS^(NOTE1)

PARAMETERS		Range	Unit
IN, SW, OUT, LED1, LED2		-0.3 to 6	V
HWEN, SCL, SDA, STROBE, TORCH/TEMP, TX		-0.3 to (VIN+0.3)	V
Continuous power dissipation		Internally limited	
Max Junction Temperature T _{JMAX}		155	°C
Storage Temperature T _{STG}		-65 to 150	°C
Maximum lead temperature (soldering)		260	°C
Junction to Ambient Thermal Resistance θ_{JA}		90.2	°C/W
ESD, All Pins ^(NOTE2)	HBM	±2000	V
	MM	±200	V
	CDM	±2000	V
Latch-Up JEDEC STANDARD NO.78B DECEMBER 2008		+IT: +350 -IT: -350	mA

RECOMMENDED OPERATING CONDITIONS

PARAMETERS	Range	Unit
V _{IN}	2.7 to 5.5	V
Junction temperature (T _J)	-40 to 125	°C
Ambient temperature (T _A)	-40 to 85	°C

NOTE1: Conditions out of those ranges listed in "absolute maximum ratings" may cause permanent damages to the device. In spite of the limits above, functional operation conditions of the device should within the ranges listed in "recommended operating conditions". Exposure to absolute-maximum-rated conditions for prolonged periods may affect device reliability.

NOTE2: The human body model is a 100pF capacitor discharged through a 1.5kΩ resistor into each pin. Test method: MIL-STD-883G Method 3015.7

ELECTRICAL CHARACTERISTICS

Typical limits tested at $T_A=25^{\circ}\text{C}$. Minimum and maximum limits apply over the full operating ambient temperature range($-40^{\circ}\text{C}\leq T_A\leq 85^{\circ}\text{C}$). Unless otherwise specified, $V_{IN}=3.6\text{V}$, $\text{HWEN}=V_{IN}$.

Symbol	Description	Test Condition	Min	Typ	Max	Unit
Vin Supply						
V_{IN}	Input operating range		2.7		5.5	V
I_Q	Quiescent supply current	Device not switching, pass mode		0.4	0.8	mA
I_{SB}	Standby supply current	Device disabled, $\text{HWEN}=1.8\text{V}$ $2.5\text{V}\leq V_{IN}\leq 5.5\text{V}$		3	10	μA
I_{SD}	Shutdown supply current	Device disabled, $\text{HWEN}=0\text{V}$ $2.5\text{V}\leq V_{IN}\leq 5.5\text{V}$		0.1	1	μA
UVLO	Under voltage lockout threshold	Falling V_{IN}		2.5		V
		Rising V_{IN}		2.6		V
Current Source Specifications						
$I_{LED1/2}$	Current source accuracy	$V_{OUT}=4\text{V}$, flash code=0x7F=1.5A	-7%	1.5	7%	A
		$V_{OUT}=4\text{V}$, torch code=0x3F=186mA	-10%	186	10%	mA
V_{OVP}	V_{OUT} over-voltage protect threshold	ON threshold	4.85	5	5.15	V
		OFF threshold	4.75	4.9	5.05	
Boost Converter Specifications						
R_{PMOS}	PMOS switch on-resistance			85		m Ω
R_{NMOS}	NMOS switch on-resistance			60		m Ω
I_{CL}	Switch current limit	Reg 0x07, bit[0]=0	-12%	1.9	12%	A
		Reg 0x07, bit[0]=1	-12%	2.8	12%	
F_{SW}	Switching frequency	Reg 0x07, bit[1]=0	-6%	2	6%	MHz
		Reg 0x07, bit[1]=1	-6%	4	6%	
V_{IVFM}	Input voltage flash monitor trip threshold	Reg 0x02, bits[3:1]="000"	-3%	2.9	3%	V
I_{NTC}	NTC current		-6%	50	6%	μA
V_{TRIP}	NTC comparator trip threshold	Reg 0x09, bit[3:1]="100"	-6%	0.6	6%	V
T_{SD}	Thermal shutdown threshold			155		$^{\circ}\text{C}$
	Thermal shutdown hysteresis			20		

Symbol	Description	Test Condition	Min	Typ	Max	Unit
I²C-Compatible Interface Specifications(SCL,SDA)						
V _{IL}	Input logic low		0		0.4	V
V _{IH}	Input logic high		1.2		V _{IN}	V
V _{OL}	Output logic low	I _{LOAD} =3mA			0.4	V
HWEN, STROBE, TORCH/TEMP, TX Voltage Specifications						
V _{IL}	Input logic low		0		0.4	V
V _{IH}	Input logic high		1.2		V _{IN}	V
R _{PD}	Internal pull down resistors			300		kΩ

I²C INTERFACE TIMING

Symbol	Description	Min	Typ	Max	Units
F _{SCL}	Interface Clock frequency			400	kHz
T _{DEGLITCH}	Deglitch time	SCL	200		ns
		SDA	250		ns
T _{HD:STA}	(Repeat-start) Start condition hold time	0.6			μs
T _{LOW}	Low level width of SCL	1.3			μs
T _{HIGH}	High level width of SCL	0.6			μs
T _{SU:STA}	(Repeat-start) Start condition setup time	0.6			μs
T _{HD:DAT}	Data hold time	0			μs
T _{SU:DAT}	Data setup time	0.1			μs
T _R	Rising time of SDA and SCL			0.3	μs
T _F	Falling time of SDA and SCL			0.3	μs
T _{SU:STO}	Stop condition setup time	0.6			μs
T _{BUF}	Time between start and stop condition	1.3			μs

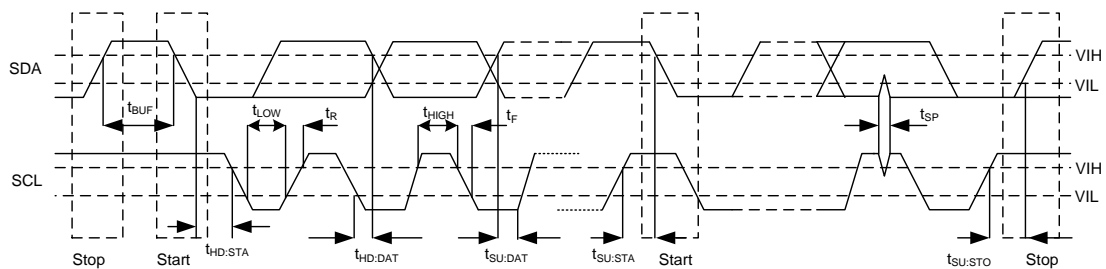

Fig 4 I²C INTERFACE TIMING

TYPICAL CHARACTERISTICS

Ambient temperature is 25°C, input voltage is 3.6 V, HWEN = IN, C_{IN} = C_{OUT} = 2×10 μF and L=1 μH, unless otherwise noted .

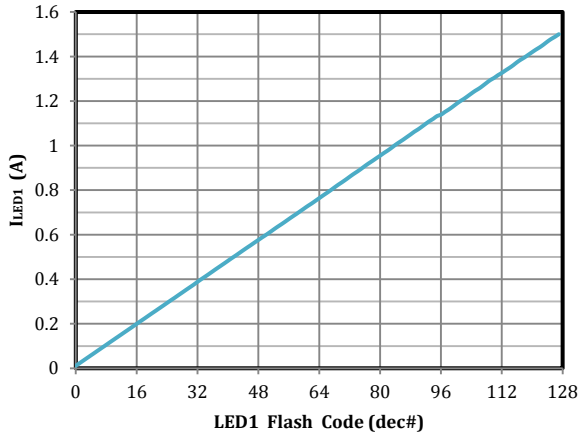

Fig 5. LED1 Flash Current vs Brightness Code

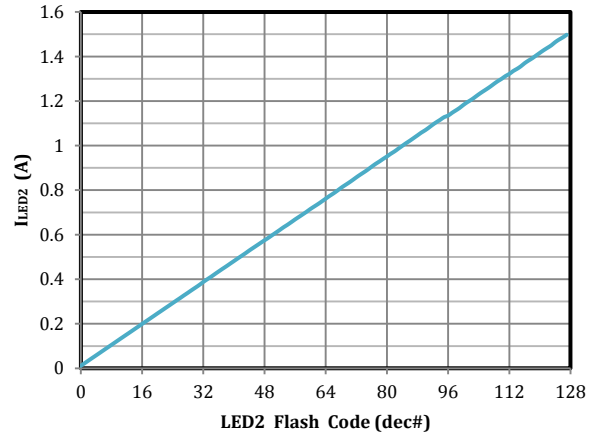

Fig 6. LED2 Flash Current vs Brightness Code

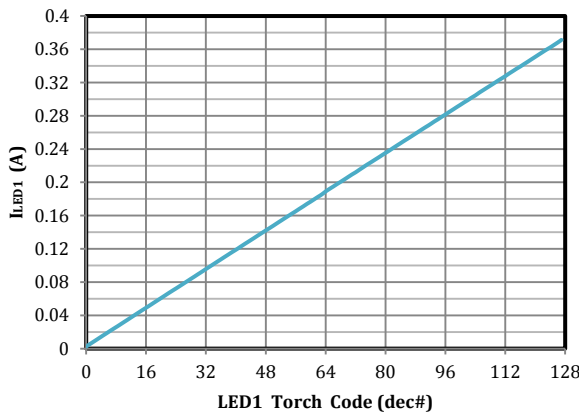

Fig 7. LED1 Torch Current vs Brightness Code

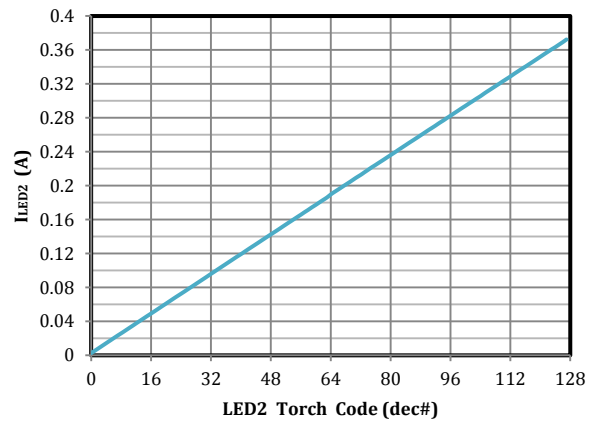

Fig 8. LED2 Torch Current vs Brightness Code

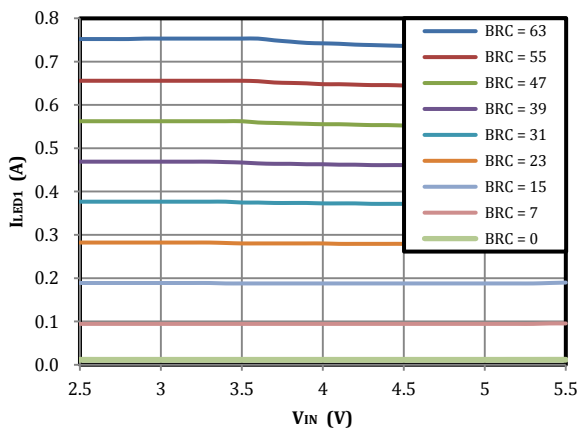

Fig 9. LED1 Flash Current vs Input Voltage

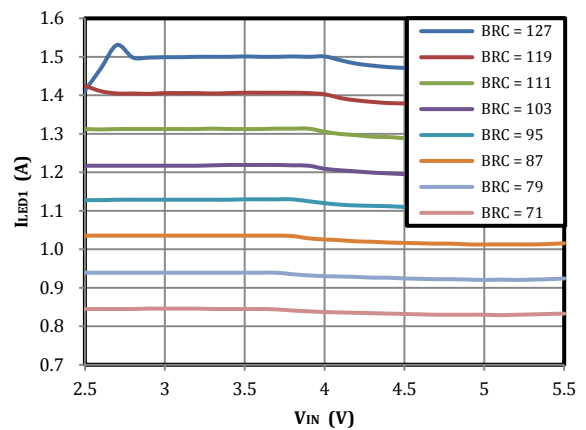

Fig 10. LED1 Flash Current vs Input Voltage

Typical Characteristics (continued)

Ambient temperature is 25°C, input voltage is 3.6 V, HWEN = IN, C_{IN} = C_{OUT} = 2×10 μF and L=1 μH, unless otherwise noted .

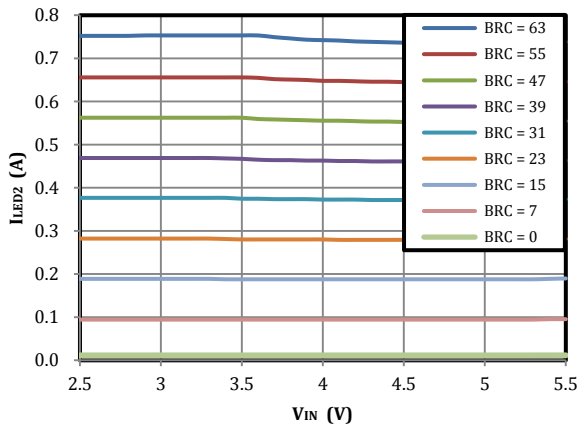

Fig 11. LED2 Flash Current vs Input Voltage

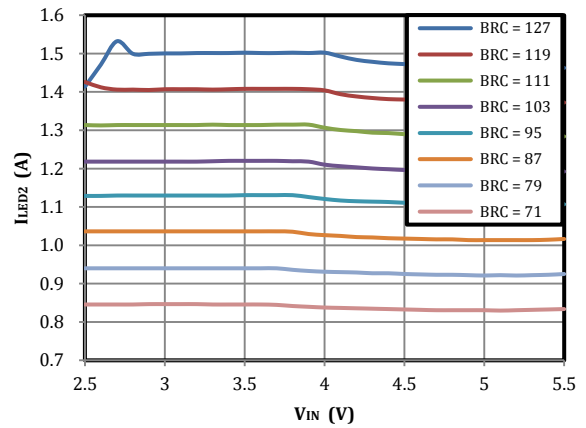

Fig 12. LED2 Flash Current vs Input Voltage

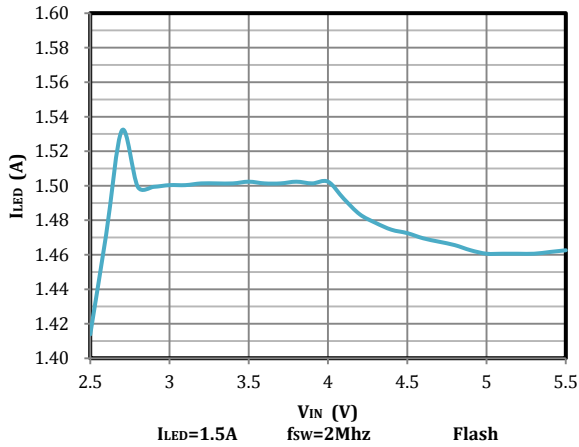

Fig 13. LED1/2 Flash Current vs Input Voltage

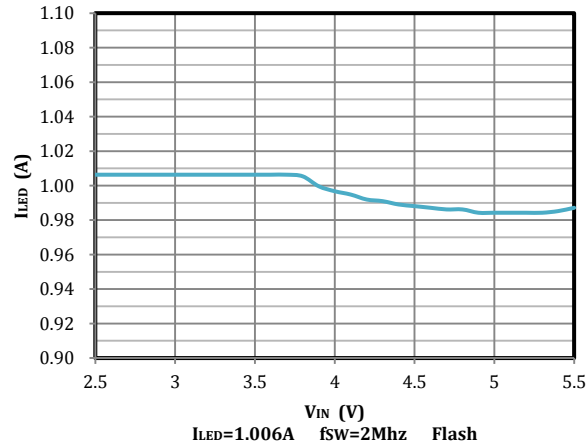

Fig 14. LED1/2 Flash Current vs Input Voltage

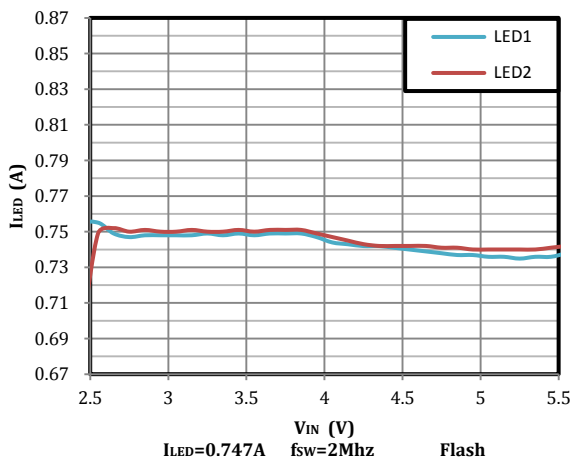

Fig 15. LED1 & LED2 Current vs Input Voltage

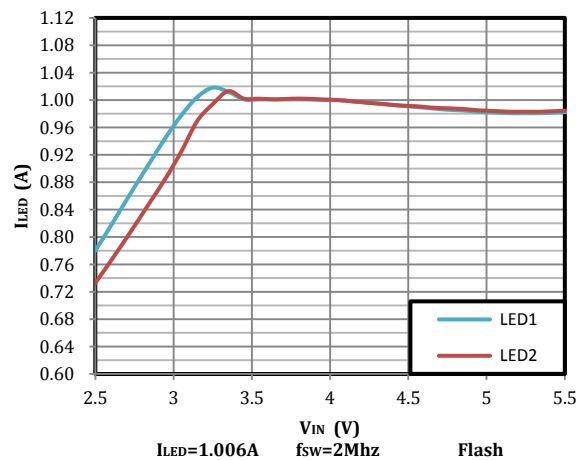

Fig 16. LED1 & LED2 Current vs Input Voltage

Typical Characteristics (continued)

Ambient temperature is 25°C, input voltage is 3.6 V, HWEN = IN, C_{IN} = C_{OUT} = 2×10 μF and L=1 μH, unless otherwise noted .

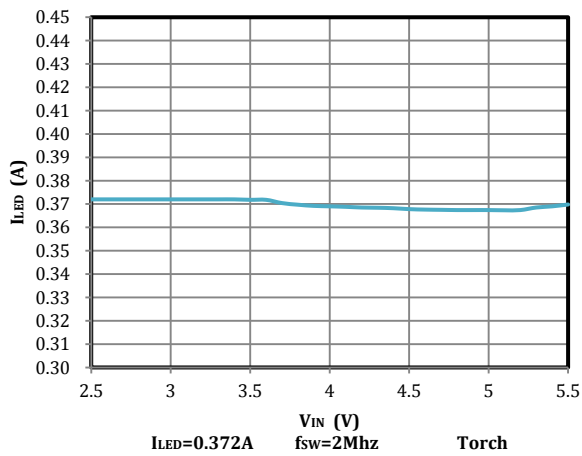

Fig 17. LED1/2 Torch Current vs Input Voltage

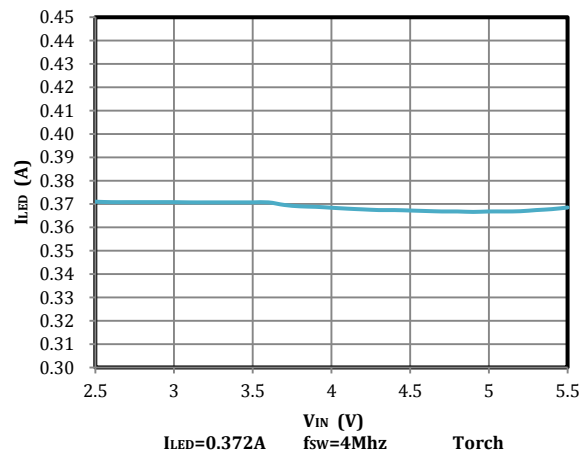

Fig 18. LED1/2 Torch Current vs Input Voltage

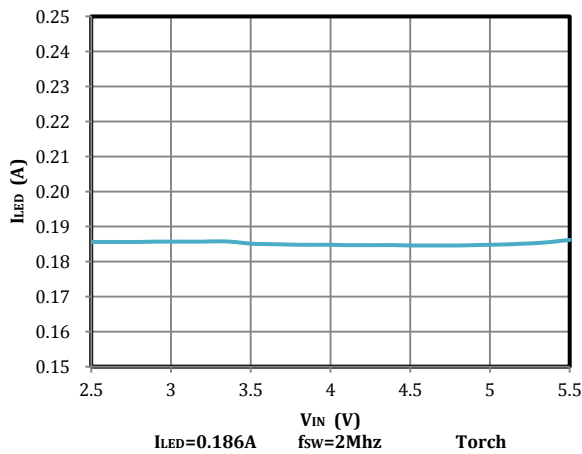

Fig 19. LED1/2 Torch Current vs Input Voltage

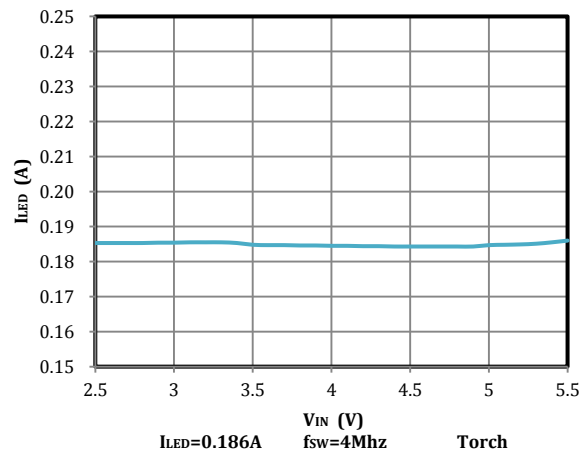

Fig 20. LED1/2 Torch Current vs Input Voltage

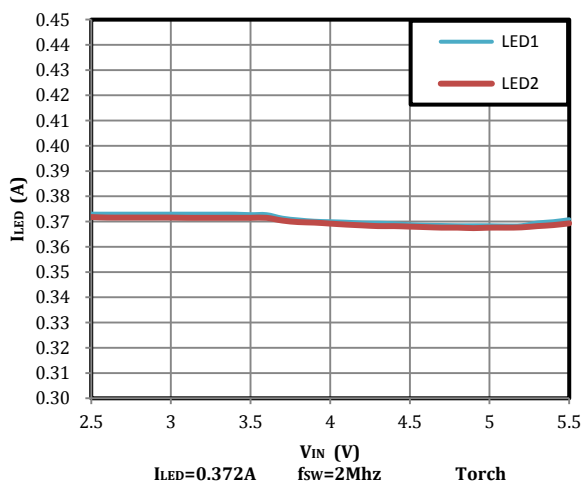

Fig 21. LED1 & LED2 Current vs Input Voltage

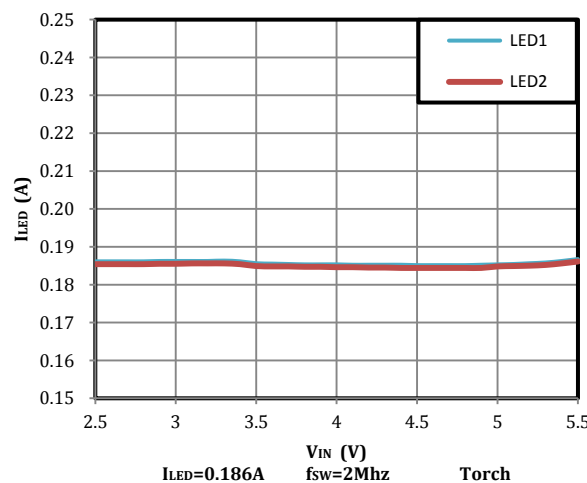

Fig 22. LED1 & LED2 Current vs Input Voltage

Typical Characteristics (continued)

Ambient temperature is 25°C, input voltage is 3.6 V, HWEN = IN, C_{IN} = C_{OUT} = 2×10 μF and L=1 μH, unless otherwise noted .

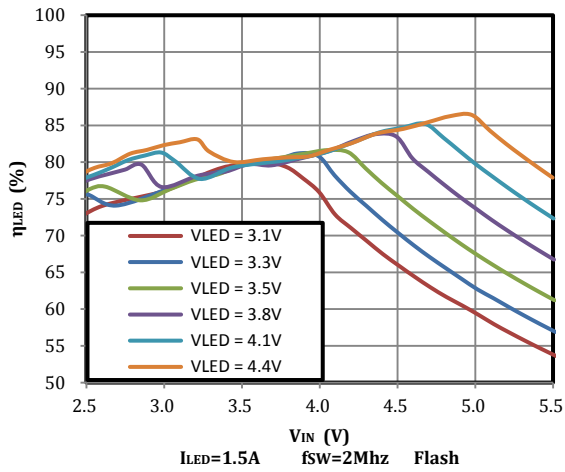

Fig23. LED Efficiency vs Input Voltage

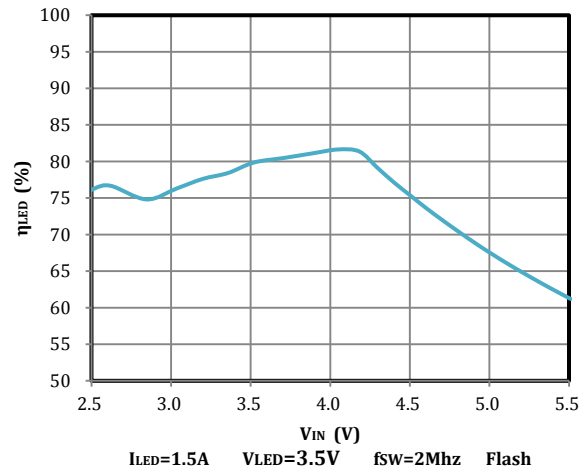

Fig24. LED Efficiency vs Input Voltage

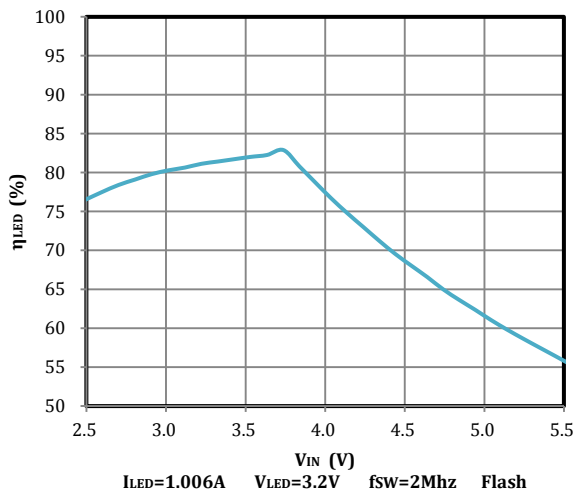

Fig25. LED Efficiency vs Input Voltage

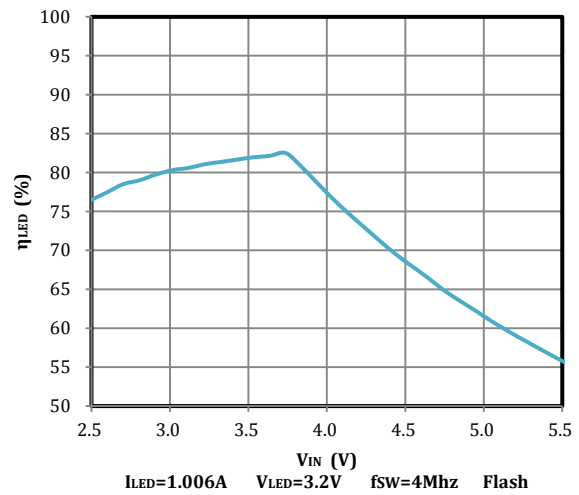

Fig26. LED Efficiency vs Input Voltage

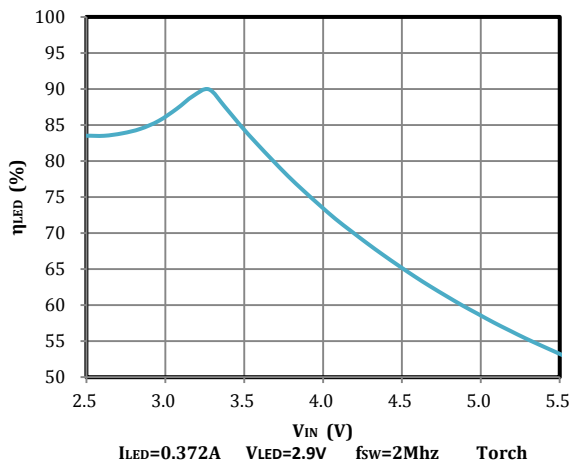

Fig27. LED Efficiency vs Input Voltage

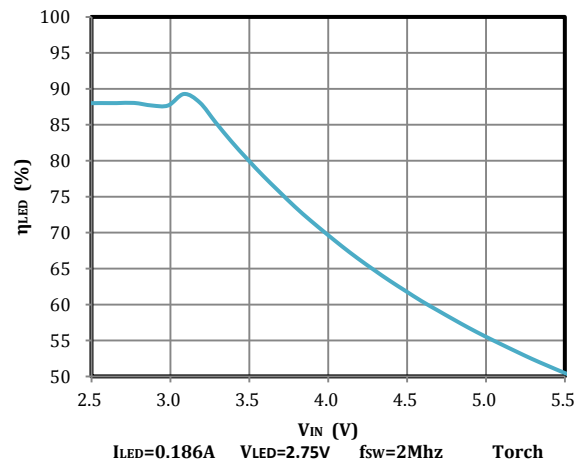

Fig28. LED Efficiency vs Input Voltage

Typical Characteristics (continued)

Ambient temperature is 25°C, input voltage is 3.6 V, HWEN = IN, C_{IN} = C_{OUT} = 2×10 μF and L=1 μH, unless otherwise noted .

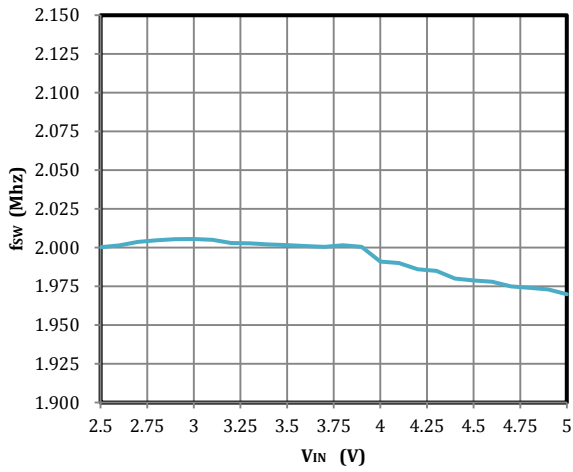

Fig 29. 2-Mhz Frequency vs Input Voltage

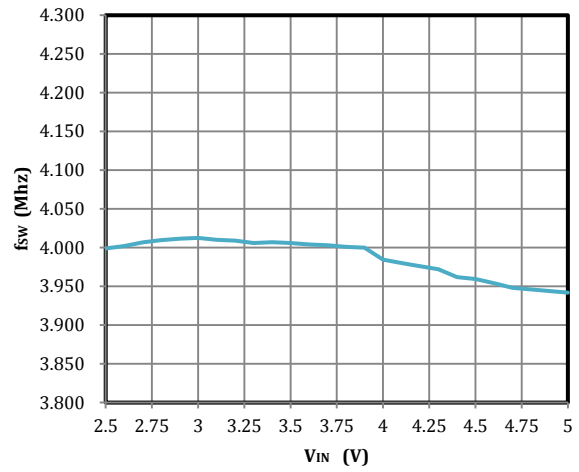

Fig 30. 4-Mhz Frequency vs Input Voltage

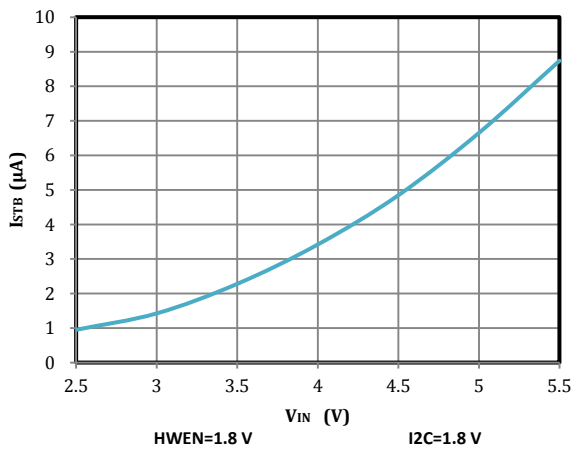

Fig 31. Standby Current vs Input Voltage

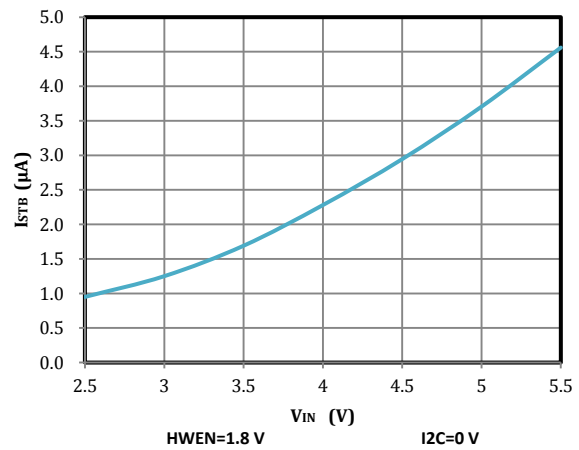

Fig 32. Standby Current vs Input Voltage

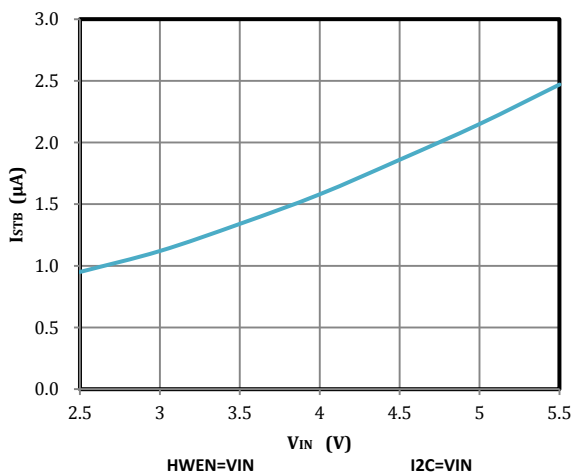

Fig 33. Standby Current vs Input Voltage

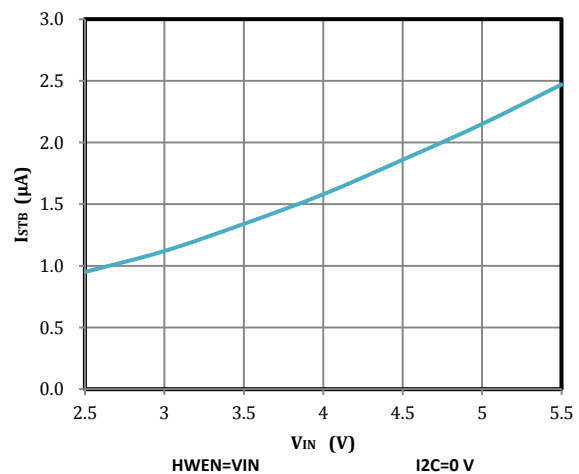

Fig 34. Standby Current vs Input Voltage

Typical Characteristics (continued)

Ambient temperature is 25°C, input voltage is 3.6 V, HWEN = IN, C_{IN} = C_{OUT} = 2×10 μF and L=1 μH, unless otherwise noted .

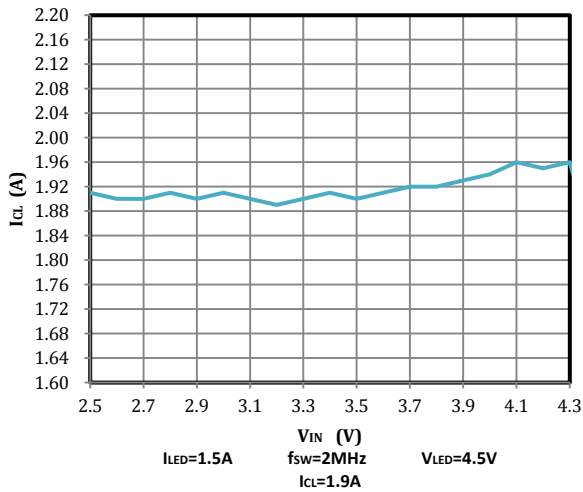

Fig 35. Inductor Current Limit vs Input Voltage

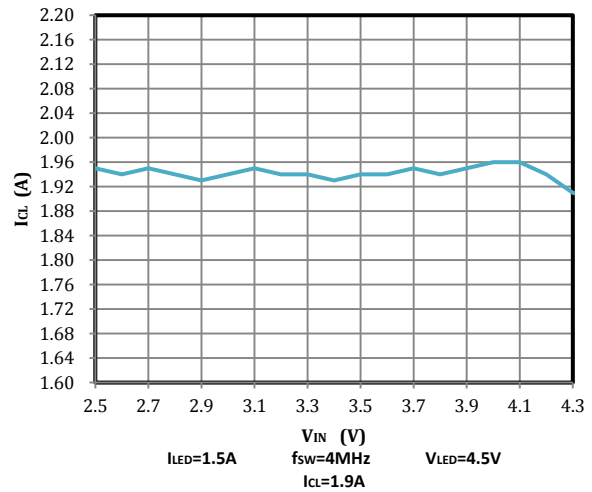

Fig 36. Inductor Current Limit vs Input Voltage

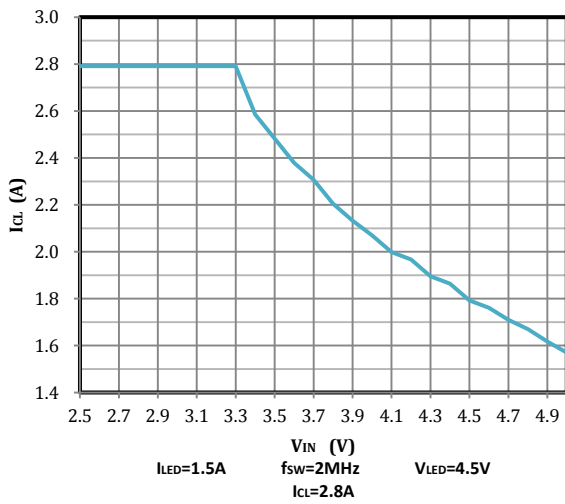

Fig 37. Inductor Current Limit vs Input Voltage

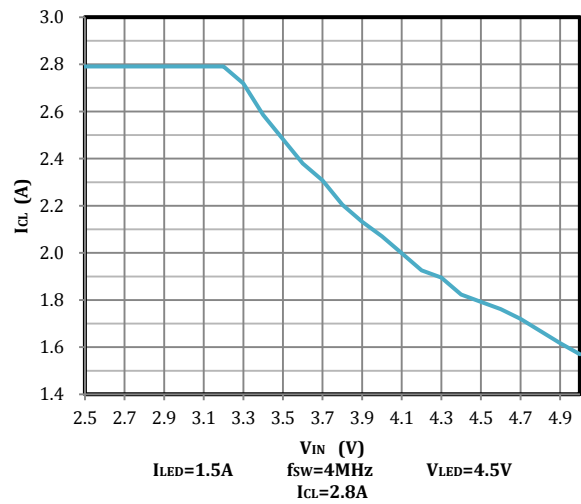

Fig 38. Inductor Current Limit vs Input Voltage

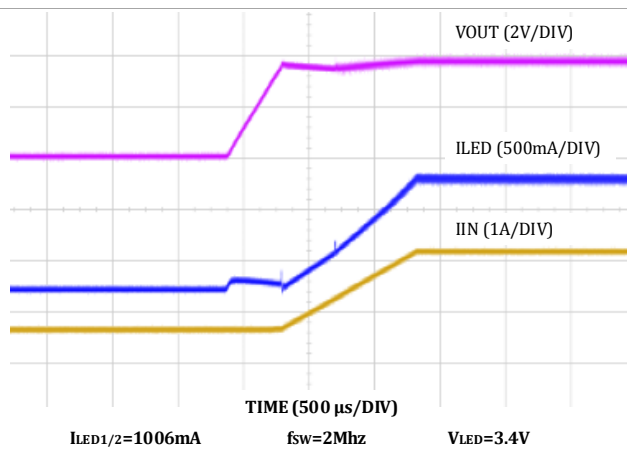

Fig 39. Ramp Up

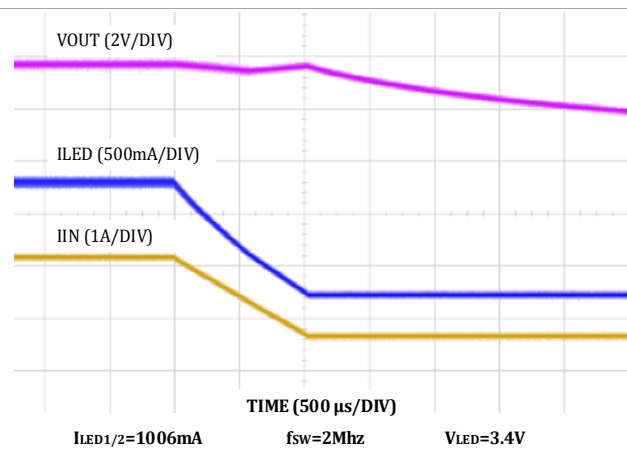

Fig 40. Ramp Down

Typical Characteristics (continued)

Ambient temperature is 25°C, input voltage is 3.6 V, HWEN = IN, C_{IN} = C_{OUT} = 2×10 μF and L=1 μH, unless otherwise noted .

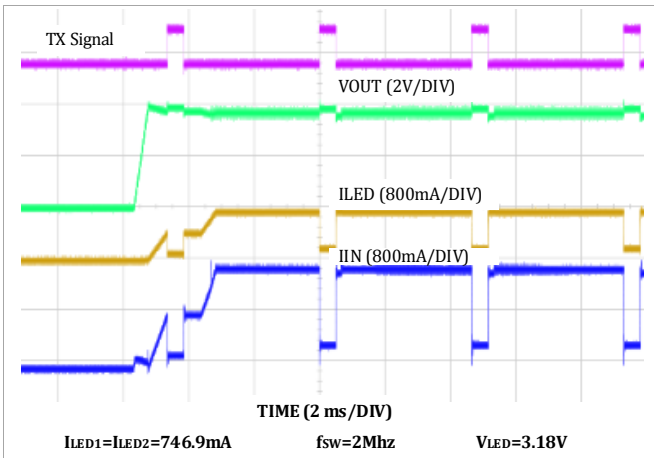

Fig 41. TX Interrupt

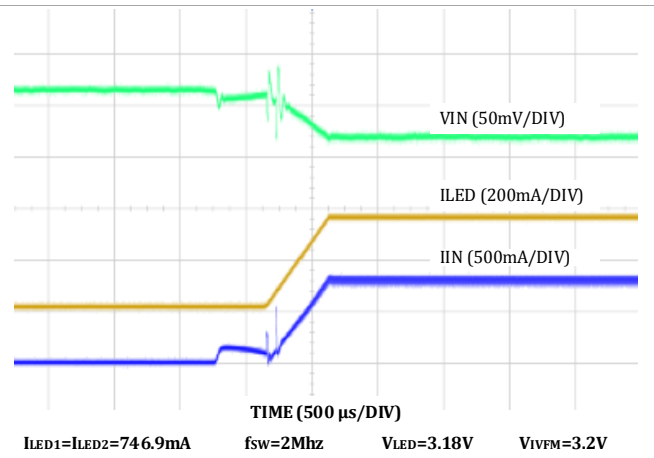

Fig 42. IVFM - Stop and Hold

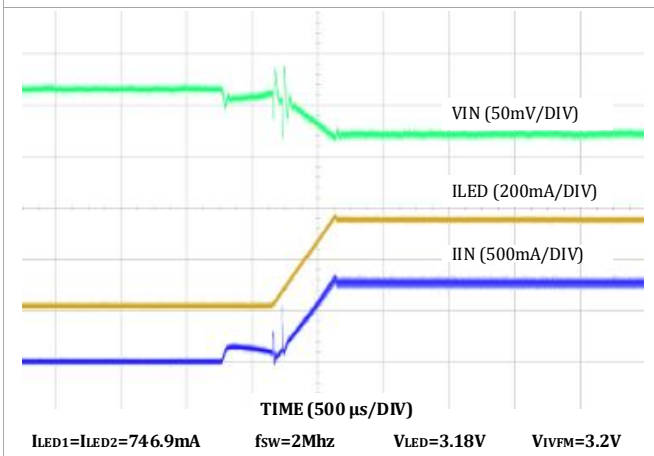

Fig 43. IVFM - Down

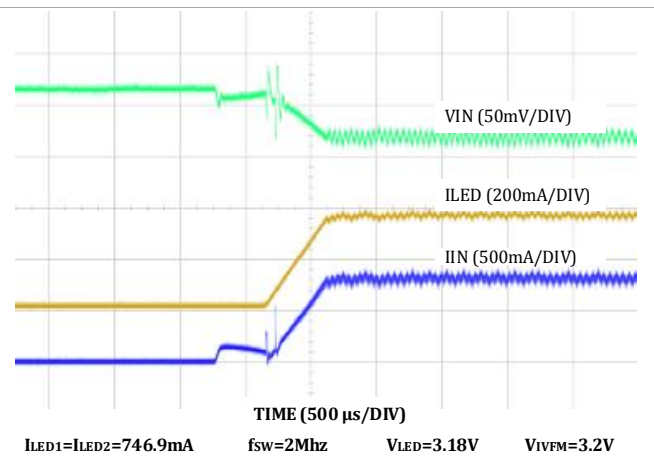

Fig 44. IVFM - Up and Down

DETAILED FUNCTIONAL DESCRIPTION

The AW36414 is a high-power white LED flash driver capable of delivering up to 1.5A in either of the two parallel LEDs. The device incorporates a 2MHz or 4MHz constant frequency-synchronous current-mode PWM boost converter and dual high-side current sources to regulate the LED current over the 2.7V to 5.5V input voltage range.

The AW36414 PWM DC-DC boost converter switches and boosts the output to maintain at least V_{HR} across each of the current sources (LED1/2). This minimum headroom voltage ensures that both current sources remain in regulation. If the input voltage is above the LED voltage + current source headroom voltage, the device would not switch, but turn the PMOS on continuously (Pass mode). In Pass mode the difference between $(V_{IN} - I_{LED} \times R_{PMOS})$ and the voltage across the LED is dropped across the current source.

The AW36414 has three logic inputs including a hardware Flash Enable (STROBE), a hardware Torch Enable (TORCH/TEMP, TORCH = default), and a Flash Interrupt input (TX) designed to interrupt the flash pulse during high battery-current conditions. These logic inputs have internal 300k Ω (typical) pull-down resistors to GND.

Additional features of the AW36414 include an internal comparator for LED thermal sensing via an external NTC thermistor and an input voltage monitor that can reduce the Flash current during low V_{IN} conditions. It also has a Hardware Enable (HWEN) pin that can be used to reset the state of the device and the registers by pulling the HWEN pin to ground.

Control is done via an I²C-compatible interface. This includes adjustment of the Flash and Torch current levels, changing the Flash Timeout Duration, and changing the switch current limit. Additionally, there are flag and status bits that indicate flash current timeout, LED over-temperature condition, LED failure (open/short), device thermal shutdown, TX interrupt, and V_{IN} under-voltage conditions.

FUNCTIONAL BLOCK DIAGRAM

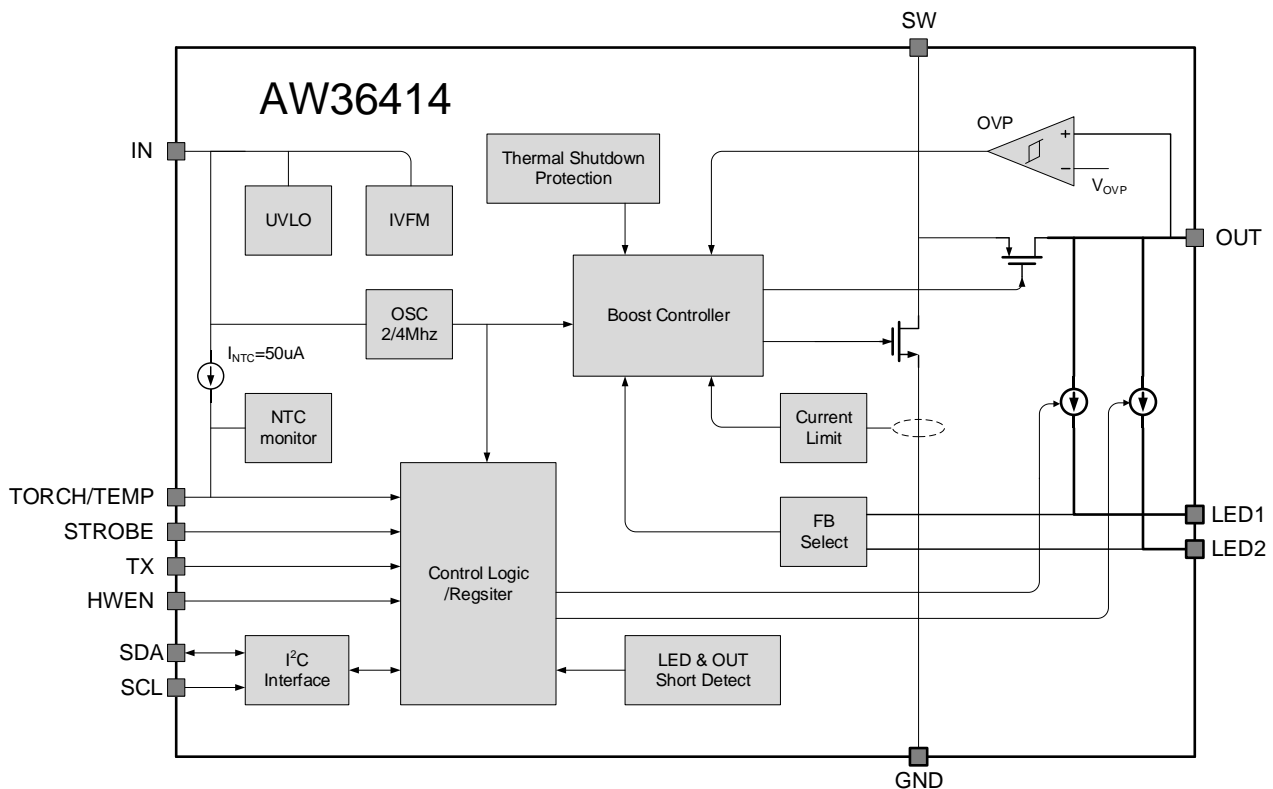

FEATURE DESCRIPTION

HWEN & I²C INTERFACE

AW3643 has a logic input HWEN pin to enable/disable the device. When HWEN is set low, the device goes into shutdown mode, the I²C interface is disabled and all I²C registers are reset to default. In shutdown mode the device does not respond to any I²C command. When HWEN is set high, the device goes into standby mode, the I²C interface is enabled, and the device can respond to I²C command.

There are two kinds of power-up sequences, shown in Figure 45 and Figure 46.

If HWEN is tied to IN pin in application, once IN goes above around V_{POR} (2.0V), HWEN should stay high for at least $t_{wait}=2ms$ time before any I²C command can be accepted.

If HWEN is driven by a GPIO, once HWEN goes from low to high, HWEN should stay high for at least $t_{wait}=2ms$ time before any I²C command can be accepted.

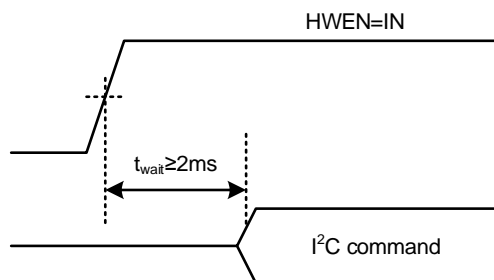

Fig 45 Power-Up Sequence with HWEN Tied to IN

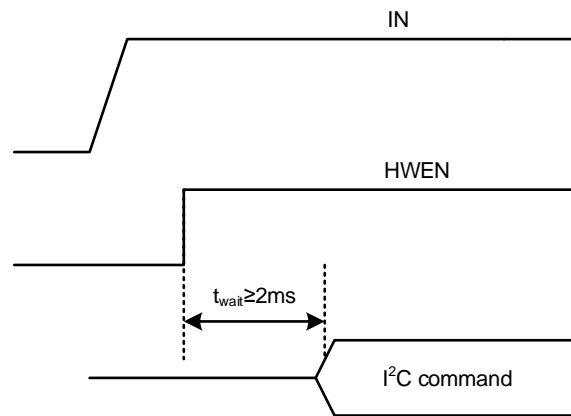

Fig 46 Power-Up Sequence with HWEN Driven by GPIO

FLASH MODE

In Flash Mode, the LED current sources (LED1/2) provide 128 target current levels from 11.35mA to 1.5A. The Flash currents are adjusted via the LED1 and LED2 Flash Brightness Registers. Flash mode is activated by the Enable Register (setting M1, M0 to '11'), or by pulling the STROBE pin HIGH when the pin is enabled (Enable Register). Once the Flash sequence is activated the current source (LED1/2) ramps up to the programmed Flash current by stepping through all current steps until the programmed current is reached.

When the device is enabled in Flash Mode through the Enable Register, all mode bits in the Enable Register are cleared after a flash timeout event.

TORCH MODE

In Torch mode, the LED current sources (LED1/2) provide 128 target current levels from 2.55mA to 372mA on AW36414. The Torch currents are adjusted via the LED1 and LED2 Torch Brightness Registers. Torch mode is activated by the Enable Register (setting M1, M0 to '10'), or by pulling the TORCH/TEMP pin HIGH when the pin is enabled (Enable Register) and set to Torch Mode. Once the TORCH sequence is activated the active current sources (LED1/2) ramps up to the programmed Torch current by stepping through all current steps until the programmed current is reached. The rate at which the current ramps is determined by the value chosen in the Timing Register.

Torch Mode is not affected by Flash Timeout or by a TX Interrupt event.

IR MODE

In IR Mode, the target LED current is equal to the value stored in the LED1/2 Flash Brightness Registers. When IR mode is enabled (setting M1, M0 to '01'), the boost converter turns on and set the output equal to the input (pass-mode). At this point, toggling the STROBE pin enables and disables the LED1/2 current sources (if enabled). The strobe pin can only be set to be Level sensitive, meaning all timing of the IR pulse is externally controlled. In IR Mode, the current sources do not ramp the LED outputs to the target. The current transitions immediately from off to on and then on to off.

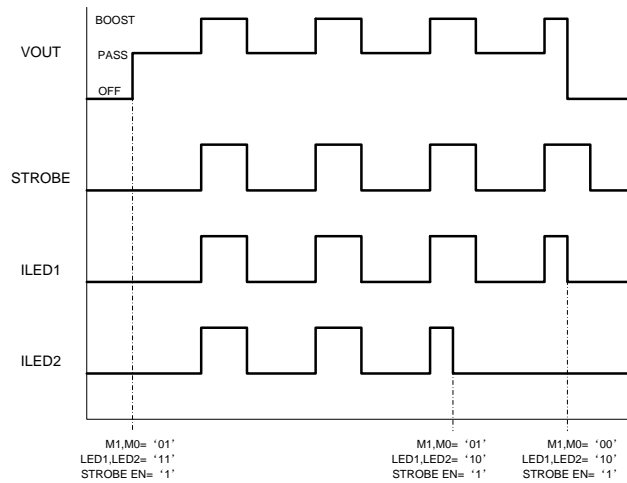

Fig 47 IR Mode with Boost

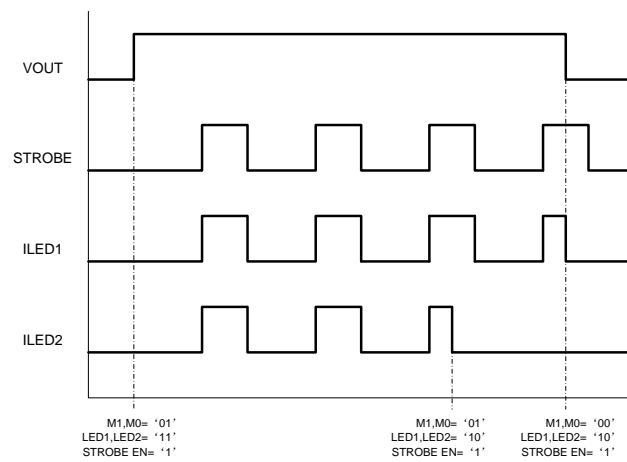

Fig 48 IR Mode Pass Only

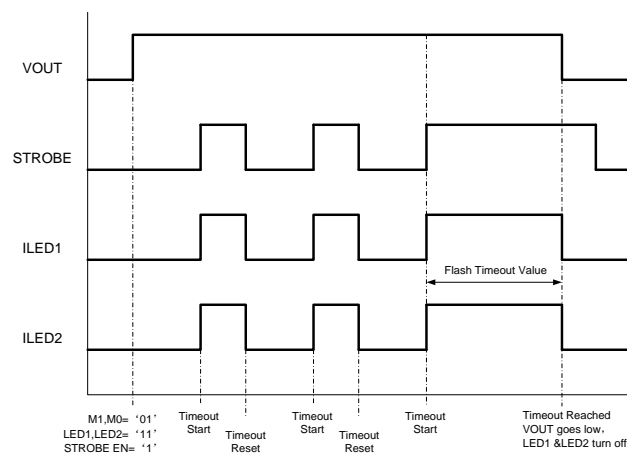

Fig 49 IR Mode Timeout

SOFT START-UP

Turn on of the AW36414 Torch and Flash modes can be done through the Enable Register. On start-up, when V_{OUT} is less than V_{IN} the internal synchronous PMOS turns on as a current source and delivers 200mA (typical) to the output capacitor. During this time the current source (LED) is off. When the voltage across the output

capacitor reaches 2.2 V (typical) the current source turns on. At turn-on the current source steps through each FLASH or TORCH level until the target LED current is reached. This gives the device a controlled turn-on and limits inrush current from the V_{IN} supply.

PASS MODE

The AW36414 starts up in Pass Mode and stays there until Boost Mode is needed to maintain regulation. In Pass Mode the boost converter does not switch, and the synchronous PMOS turns fully on bringing V_{OUT} up to $V_{IN} - I_{LED} \times R_{PMOS}$. In Pass Mode the inductor current is not limited by the peak current limit. If the voltage difference between V_{OUT} and V_{LED} falls below V_{HR} , the device switches to Boost Mode.

POWER AMPLIFIER SYNCHRONIZATION (TX)

The TX pin is a Power Amplifier Synchronization input. This is designed to reduce the flash LED current and thus limit the battery current during high battery current conditions such as PA transmit events. When the AW36414 is engaged in a Flash event, and the TX pin is pulled high, the LED current is forced into Torch Mode at the programmed Torch current setting. If the TX pin is then pulled low before the Flash pulse terminates, the LED current returns to the previous Flash current level. At the end of the Flash time-out, whether the TX pin is high or low, the LED current turns off.

The TX input can be disabled by setting bit[7] (TX Enable) to a '0' in the Enable Register(0x01).

INPUT VOLTAGE FLASH MONITOR (IVFM)

The AW36414 has the ability to adjust the flash current based upon the voltage level present at the IN pin utilizing the Input Voltage Flash Monitor (IVFM). The adjustable threshold ranges from 2.9 V to 3.6 V in 100mV steps as well as adjustable hysteresis, with three different usage modes (Stop and Hold, Down, Up and Down). The IVFM threshold and hysteresis are controlled by bits[5:3] and bit[2] respectively, in the IVFM Register(0x02). The Flags2 Register has the IVFM flag bit set when the input voltage crosses the IVFM threshold value. Additionally, the IVFM threshold sets the input voltage boundary that forces the AW36414 to either stop ramping the flash current during startup in Stop and Hold Mode, or to actively adjust the LED current lower in Down Mode, or to continuously adjust the LED current up and down in Up & Down Mode.

- Stop and Hold Mode: Stops Current Ramp and holds the level for the remaining flash, If V_{IN} falls below the IVFM threshold value.
- Down Mode: Adjust current down if V_{IN} falls below the IVFM threshold value and stops decreasing once V_{IN} rises above the IVFM threshold (or plus a hysteresis). The AW36414 will decrease the current throughout the flash pulse anytime V_{IN} falls below the IVFM threshold, not just once. The flash current will not increase again until the next flash.
- Up & Down Mode: Adjust current down if V_{IN} falls below the IVFM threshold value and adjusts current up if V_{IN} rises above the IVFM threshold (or plus a hysteresis). In Up & Down mode, the LED current will continually adjust with the rising and falling of V_{IN} throughout the entire flash pulse.

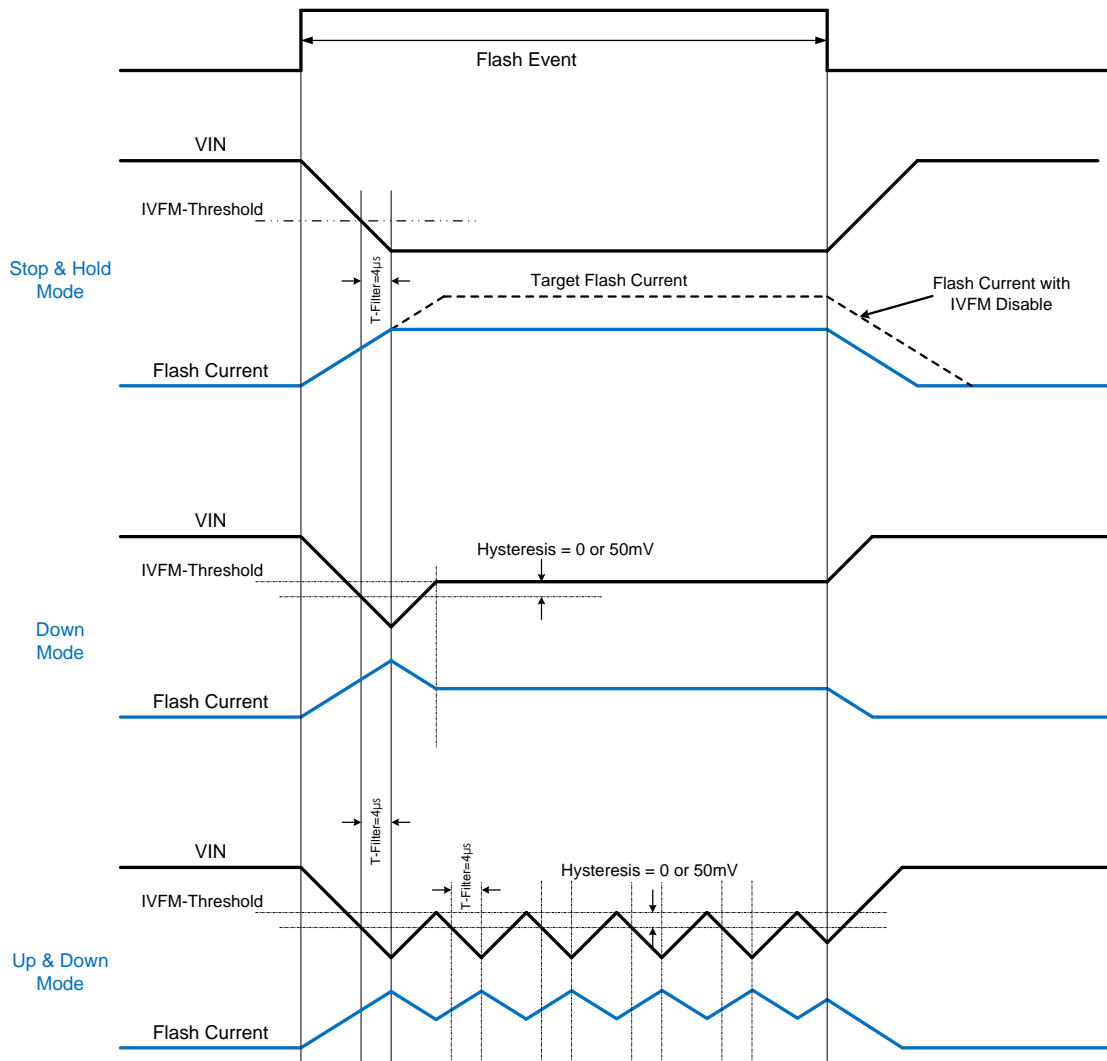

Fig 50 IVFM Modes

FLASH TIMEOUT

The Flash Timeout period sets the maximum time of one flash event, whether a flash stop command is received or not. The AW36414 has 16 timeout levels ranging from 40ms to 1.6s (see [TIMING CONFIGURATION REGISTER \(0X08\)](#) for more detail). Flash Timeout applies to both Flash and IR modes, and it continues to count when the Flash mode is forced into Torch mode during a TX high event. The mode bits are cleared and bit[0] is set in the Flags1 register(0x0A) upon a Flash Timeout. This fault flag can be reset to '0' by reading back the Flags1 Register (0x0A), or by setting HWEN to '0', or by setting the SW RESET bit to a '1', or by removing power to the AW36414.

CURRENT LIMIT

When the inductor current limit is reached, the AW36414 terminates the charging phase of the switching cycle until the next switching period. If the over-current condition persists, the device operates continuously in current limit. The AW36414 features two selectable inductor current limits(1.9A and 2.8A) that are programmable by bit[0] in Boost configuration Register(0x07).

Since the current limit is sensed in the NMOS switch, there is no mechanism to limit the current when the device operates in Pass Mode (current does not flow through the NMOS in pass mode). The mode bits are not cleared upon a Current Limit event, but a flag bit[3] is set in the Flags1 register(0x0A).

This fault flag can be reset to '0' by reading back the Flags1 Register (0x0A), or by setting HWEN to '0', or by setting the SW RESET bit to a '1', or by removing power to the AW36414.

NTC THERMISTOR INPUT (TORCH/TEMP)

The TORCH/TEMP pin, when set to TEMP mode, serves as a threshold detector and bias source for negative temperature coefficient (NTC) thermistors. When the voltage at TEMP goes below the programmed threshold, bit[0] is set to a '1', and the AW36414 is placed into standby mode. The NTC threshold voltage is adjustable from 200 mV to 900 mV in 100-mV steps. The NTC bias current is set to 50µA. The NTC detection circuitry can be enabled or disabled via the Enable Register. If enabled, the NTC block turns on and off during the start and stop of a Flash/Torch event.

Additionally, the NTC input looks for an open NTC connection and a shorted NTC connection. If the NTC input falls below 100 mV, the NTC short flag is set(bit[4] in the Flags2 Register), and the AW36414 is forced into standby mode. If the NTC input rises above 2.3 V, the NTC Open flag is set(bit[3] in the Flags2 Register), and the AW36414 is forced into standby mode. These fault detections can be individually disabled/enabled via the NTC Open Fault Enable bit and the NTC Short Fault Enable bit in Temp register(0x09)

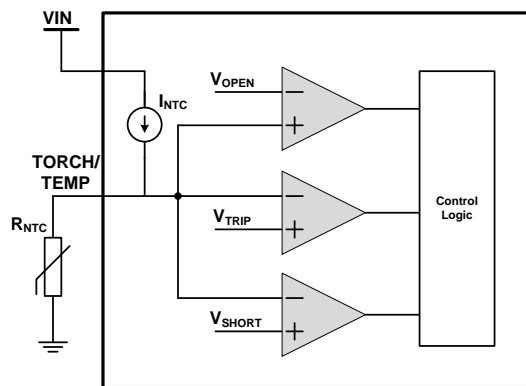

Fig 51 Temp Detection Diagram

The AW36414 is not available for operation until Flags2 register is cleared. The three NTC fault flags can be reset to '0' by reading back the Flags2 Register (0x0B), or by setting HWEN to '0', or by setting the SW RESET bit to a '1', or by removing power to the AW36414.

UNDERVOLTAGE LOCKOUT (UVLO)

The AW36414 has an internal comparator that monitors the voltage at IN and forces the AW36414 into standby if the input voltage drops to 2.5 V. If the UVLO monitor threshold is tripped, the UVLO flag bit is set in the Flags1 Register (0x0A). If the input voltage rises above 2.5 V, the AW36414 is not available for operation until there is an I²C read of the Flags1 Register (0x0A). Upon a read, the Flags1 register is cleared, and normal operation can resume if the input voltage is greater than 2.5 V.

VOUT SHORT FAULT

The Output Short Fault flag reads back a '1' if the device is active in Flash or Torch mode and the boost output experiences a short condition. VOUT short condition occurs if the voltage at OUT goes below 2.3V (typ.) while the device is in Torch or Flash mode. There is a deglitch time of 2.048ms before the VOUT Short flag is valid. The mode bits are cleared upon an the VOUT short fault. The AW36414 is not available for operation until VOUT Fault flags is cleared. The VOUT Short Faults can be reset to '0' by reading back the Flags1 Register (0x0A), or by setting HWEN to '0', or by setting the SW RESET bit to a '1', or by removing power to the AW36414.

LED SHORT FAULT

The LED Short Fault flags read back a '1' if the device is active in Flash or Torch mode and either active LED output experiences a short condition. An LED short condition is determined if the voltage at LED1 or LED2 goes below 500mV (typ.) while the device is in Torch or Flash mode. There is a deglitch time of 256 μ s before the LED Short Fault flag is valid. The mode bits are cleared upon an LED short fault. The AW36414 is not available for operation until the LED Short Fault flags is cleared. The LED Short Faults can be reset to '0' by reading back the Flags1 Register (0x0A), or by setting HWEN to '0', or by setting the SW RESET bit to a '1', or by removing power to the AW36414.

OVERVOLTAGE PROTECTION (OVP)

The output voltage is limited to typically 5 V. In situations such as an open LED, the AW36414 raises the output voltage in order to try and keep the LED current at its target value. When VOUT reaches 5 V (typ.) the overvoltage comparator trips and turns off the internal NMOS. When VOUT falls below the "V_{OVP} Off Threshold", the AW36414 begins switching again. The mode bits are cleared, and the OVP Fault flag is set, when an OVP condition is present for three rising OVP edges. This prevents momentary OVP events from forcing the device to shut down. The AW36414 is not available for operation until the OVP Fault flag is cleared. The OVP Fault can be reset to '0' by reading back the Flags2 Register (0x0A), or by setting HWEN to '0', or by setting the SW RESET bit to a '1', or by removing power to the AW36414.

THERMAL SHUTDOWN (TSD)

When the AW36414 die temperature reaches 155°C, the thermal shutdown detection circuit trips, forcing the AW36414 into standby and writing a '1' to the Thermal Shutdown Fault flag of the Flags1 Register (0x0A) . The AW36414 is only allowed to restart after the Thermal Shutdown Fault flag is cleared. The Thermal Shutdown Faults can be reset to '0' by reading back the Flags1 Register (0x0A), or by setting HWEN to '0', or by setting the SW RESET bit to a '1', or by removing power to the AW36414. Upon restart, if the die temperature is still above 155°C, the AW36414 resets the Fault flag and re-enters standby.

PROGRAMMING

CONTROL TRUTH TABLE

MODE1	MODE0	STROBE EN	TORCH EN	STROBE PIN	TORCH PIN	ACTION
0	0	0	0	X	X	Standby
0	0	0	1	X	Pos edge	Ext Torch
0	0	1	0	Pos edge	X	Ext Flash
0	0	1	1	0	Pos edge	Standalone Torch
0	0	1	1	Pos edge	0	Standalone Flash
0	0	1	1	Pos edge	Pos edge	Standalone Flash
1	0	X	X	X	X	Int Torch
1	1	X	X	X	X	Int Flash
0	1	0	X	X	X	IRLED Standby
0	1	1	X	0	X	IRLED Standby
0	1	1	X	Pos edge	X	IRLED enabled

I²C INTERFACE

Data Validation

When SCL is high level, SDA level must be constant. SDA can be changed only when SCL is low level.

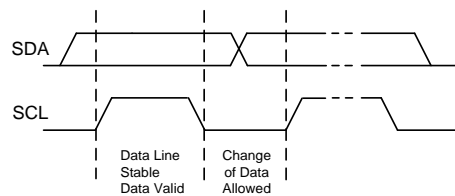

Fig 52 Data Validation Diagram

I²C Start/Stop

I²C start: SDA changes from high level to low level when SCL is high level.

I²C stop: SDA changes from low level to high level when SCL is high level.

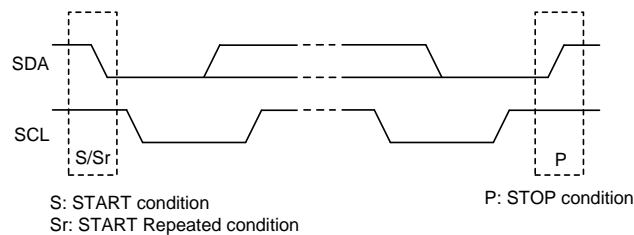

Fig 53 Start and Stop Conditions

ACK (Acknowledgement)

ACK means the successful transfer of I²C bus data. After master sends 8bits data, SDA must be released; SDA is pulled to GND by slave device when slave acknowledges.

When master reads, slave device sends 8bit data, releases the SDA and waits for ACK from master. If ACK is send and I²C stop is not send by master, slave device sends the next data. If ACK is not send by master, slave device stops to send data and waits for I²C stop.

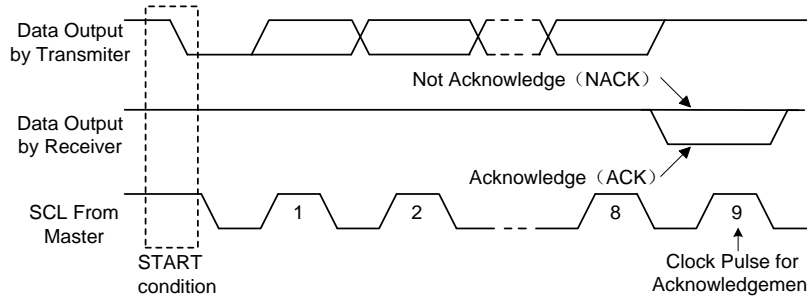

Fig 54 Acknowledgement Diagram

Write Cycle

One data bit is transferred during each clock pulse. Data is sampled during the high state of the serial clock (SCL). Consequently, throughout the clock’s high period, the data should remain stable. Any changes on the SDA line during the high state of the SCL and in the middle of a transaction, aborts the current transaction. New data should be sent during the low SCL state. This protocol allows a single data line to transfer both command/control information and data using the synchronous serial clock.

Each data transaction is composed of a Start Condition, a number of byte transfers (set by the software) and a Stop Condition to terminate the transaction. Every byte written to the SDA bus must be 8 bits long and is transferred with the most significant bit first. After each byte, an Acknowledge signal must follow.

In a write process, the following steps should be followed:

- a) Master device generates START condition. The “START” signal is generated by lowering the SDA signal while the SCL signal is high.
- b) Master device sends slave address (7-bit) and the data direction bit (r/w = 0).
- c) Slave device sends acknowledge signal if the slave address is correct.
- d) Master sends control register address (8-bit)
- e) Slave sends acknowledge signal
- f) Master sends data byte to be written to the addressed register
- g) Slave sends acknowledge signal
- h) If master will send further data bytes the control register address will be incremented by one after acknowledge signal (repeat step 6, 7)
- i) Master generates STOP condition to indicate write cycle end

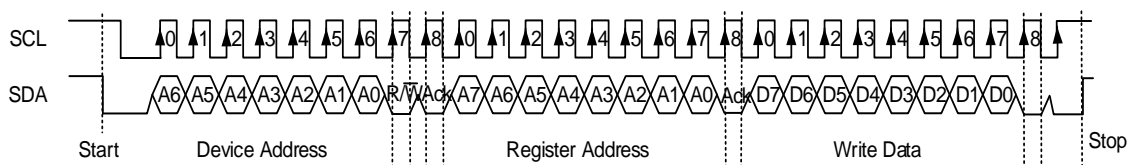

Fig 55 I²C Write Timing

Read Cycle

In a read cycle, the following steps should be followed:

- a) Master device generates START condition
- b) Master device sends slave address (7-bit) and the data direction bit ($r/w = 0$).
- c) Slave device sends acknowledge signal if the slave address is correct.
- d) Master sends control register address (8-bit)
- e) Slave sends acknowledge signal
- f) Master generates STOP condition followed with START condition or REPEAT START condition
- g) Master device sends slave address (7-bit) and the data direction bit ($r/w = 1$).
- h) Slave device sends acknowledge signal if the slave address is correct.
- i) Slave sends data byte from addressed register.
- j) If the master device sends acknowledge signal, the slave device will increase the control register address by one, then send the next data from the new addressed register.
- k) If the master device generates STOP condition, the read cycle is ended.

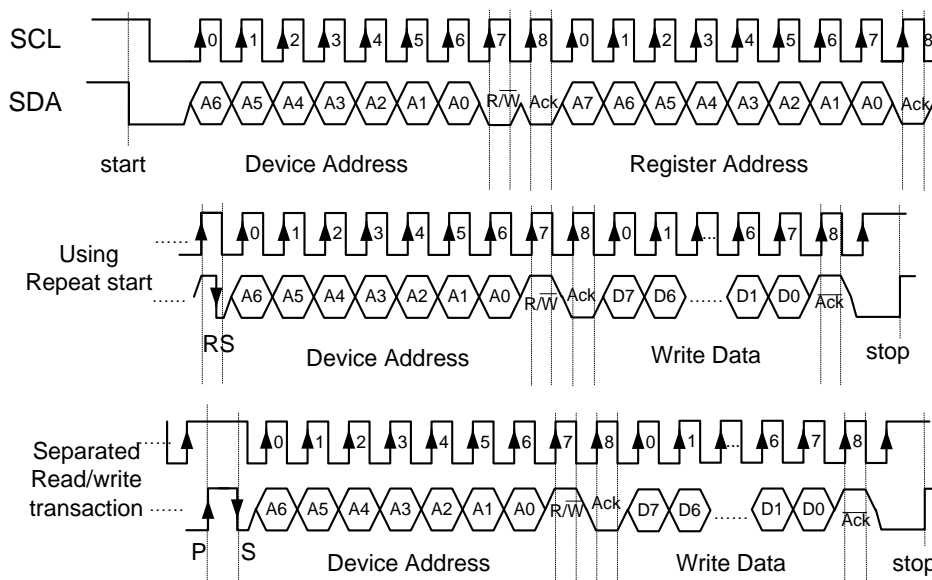

Fig 56 I²C Read Timing

REGISTER CONFIGURATION

REGISTER LIST

Register name	Address(HEX)	Read/Write	Default Value
Chip ID Register	0x00	Read	0x36
Enable Register	0x01	Read/Write	0x80
IVFM Register	0x02	Read/Write	0x01
LED1 Flash Brightness Register	0x03	Read/Write	0xBF
LED2 Flash Brightness Register	0x04	Read/Write	0x3F
LED1 Torch Brightness Register	0x05	Read/Write	0xBF
LED2 Torch Brightness Register	0x06	Read/Write	0x3F
Boost Configuration Register	0x07	Read/Write	0x09
Timing Configuration Register	0x08	Read/Write	0x1A
Temp Register	0x09	Read/Write	0x08
Flags1 Register	0x0A	Read	0x00
Flags2 Register	0x0B	Read	0x00
Device ID Register	0x0C	Read	0x02
Last Flash Register	0x0D	Read	0x00
Indicator Current Register	0x39	Read/Write	0x7F

REGISTER DETAILED DESCRIPTION

✧ Chip ID Register (0x00)

Bit 7	Bit 6	Bit 5	Bit 4	Bit 3	Bit 2	Bit 1	Bit 0
Chip ID: "00110110"							

✧ Enable Register (0x01)

Bit 7	Bit 6	Bit 5	Bit 4	Bit 3	Bit 2	Bit 1	Bit 0
TX Pin Enable 0=Disabled 1=Enabled (Default)	Strobe Type 0=Level Triggered (Default) 1=Edge Triggered	Strobe Enable 0=Disabled (Default) 1=Enabled	Torch/Temp Pin Enable 0=Disabled (Default) 1=Enabled	Mode Bits: M1, M0 00=Standby (Default) 01=IR Drive 10=Torch 11=Flash		LED2 Enable 0=OFF (Default) 1=ON	LED1 Enable 0=OFF (Default) 1=ON

Note:

In Edge or Level Strobe Mode, it is recommended that the trigger pulse width be set greater than 1ms to ensure proper turn-on of the device.

◇ IVFM Register (0x02)

Bit 7	Bit 6	Bit 5	Bit 4	Bit 3	Bit 2	Bit 1	Bit 0
RFU	UVLO Circuitry 0=Disabled (Default) 1=Enabled	IVFM Levels 000=2.9 V (Default) 001=3.0 V 010=3.1 V 011=3.2 V 100=3.3 V 101=3.4 V 110=3.5 V 111=3.6 V			IVFM Hysteresis 0=0 mV (Default) 1=50 mV	IVFM Mode Selection 00=Disabled 01=Stop and Hold Mode (Default) 10=Down Mode 11=Up and Down Mode	

◇ LED1 Flash Brightness Register (0x03)

Bit 7	Bit 6	Bit 5	Bit 4	Bit 3	Bit 2	Bit 1	Bit 0
LED2 Flash Current Override 0=LED2 Flash Current is not set to LED1 Flash Current 1=LED2 Flash Current is set to LED1 Flash Current (Default)	LED1 Flash Brightness Levels $I_{FLASH}(mA) \approx (\text{Brightness Code} * 11.72mA) + 11.35mA$ 0000000=11.35 mA 0111111=746.9 mA (Default) 1111111=1.5 A						

◇ LED2 Flash Brightness Register (0x04)

Bit 7	Bit 6	Bit 5	Bit 4	Bit 3	Bit 2	Bit 1	Bit 0
RFU	LED2 Flash Brightness Levels $I_{FLASH}(mA) \approx (\text{Brightness Code} * 11.72mA) + 11.35mA$ 0000000=11.35 mA 0111111=746.9 mA (Default) 1111111=1.5 A						

◇ LED1 Torch Brightness Register (0x05)

Bit 7	Bit 6	Bit 5	Bit 4	Bit 3	Bit 2	Bit 1	Bit 0
LED2 Torch Current Override 0=LED2 Torch Current is not set to LED1 Torch Current 1=LED2 Torch Current is set to LED1 Torch Current (Default)	LED1 Torch Brightness Levels $I_{TORCH}(mA) \approx (\text{Brightness Code} * 2.91mA) + 2.55mA$ 0000000=2.55 mA 0111111=186 mA (Default) 1111111=372 mA						

◇ LED2 Torch Brightness Register (0x06)

Bit 7	Bit 6	Bit 5	Bit 4	Bit 3	Bit 2	Bit 1	Bit 0
RFU	LED2 Torch Brightness Levels $I_{TORCH}(mA) \approx (\text{Brightness Code} * 2.91mA) + 2.55mA$ 0000000=2.55 mA 0111111=186 mA (Default) 1111111=372 mA						

◇ Boost Configuration Register (0x07)

Bit 7	Bit 6	Bit 5	Bit 4	Bit 3	Bit 2	Bit 1	Bit 0
Software Reset Bit 0=Not Reset (Default) 1=Reset	RFU	RFU	RFU	LED Pin Short Fault Detect 0=Disabled (Default) 1=Enabled (Default)	Boost Mode 0=Normal (Default) 1=Pass Mode Only	Boost Frequency Select 0=2 MHz (Default) 1=4 MHz	Boost Current Limit 0=1.9A 1=2.8A (Default)

◇ Timing Configuration Register (0x08)

Bit 7	Bit 6	Bit 5	Bit 4	Bit 3	Bit 2	Bit 1	Bit 0
RFU	Torch Current Ramp time 000=No Ramp 001=1 ms (Default) 010=32 ms 011=64 ms 100=128 ms 101=256 ms 110=512 ms 111=1024 ms			Flash Time-out Duration 0000=40 ms 0001=80 ms 0010=120 ms 0011=160 ms 0100=200 ms 0101=240 ms 0110=280 ms 0111=320 ms 1000=360 ms 1001=400 ms 1010=600 ms (Default) 1011=800 ms 1100=1000 ms 1101=1200 ms 1110=1400 ms 1111=1600 ms			

◇ Temp Register (0x09)

Bit 7	Bit 6	Bit 5	Bit 4	Bit 3	Bit 2	Bit 1	Bit 0
RFU	TORCH Polarity 0=Active High (Default) (Pull-down Resistor Enabled) 1=Active Low (Pull-down Resistor Disabled)	NTC Open Fault Enable 0=Disabled (Default) 1=Enabled	NTC Short Fault Enable 0=Disabled (Default) 1=Enabled	TEMP Detect Voltage Thresholds 000=200 mV 001=300 mV 010=400 mV 011=500 mV 100=600 mV (Default) 101=700 mV 110=800 mV 111=900 mV			TORCH/TEMP Function Select 0=TORCH (Default) 1=TEMP

◇ Flags1 Register (0x0A)

Bit 7	Bit 6	Bit 5	Bit 4	Bit 3	Bit 2	Bit 1	Bit 0
TX Flag	V_{OUT} Short Fault	LED1 Short Fault	LED2 Short Fault	Current Limit Flag	Thermal Shutdown (TSD) Fault	UVLO Fault	Flash Time-Out Flag

◇ Flags2 Register (0x0B)

Bit 7	Bit 6	Bit 5	Bit 4	Bit 3	Bit 2	Bit 1	Bit 0
RFU	RFU	RFU	NTC Short Fault	NTC Open Fault	IVFM Trip Flag	OVP Fault	TEMP Trip Fault

◇ **Device ID Register (0x0C)**

Bit 7	Bit 6	Bit 5	Bit 4	Bit 3	Bit 2	Bit 1	Bit 0
RFU	RFU	Device ID "000"			Silicon Revision Bits "010"		

◇ **Last Flash Register (0x0D)**

Bit 7	Bit 6	Bit 5	Bit 4	Bit 3	Bit 2	Bit 1	Bit 0
RFU	The value stored is always the last current value the IVFM detection block set $I_{LED}=I_{FLASH-TARGET}*((code+1)/128)$						

◇ **Indicator Current Register (0x39)**

Bit 7	Bit 6	Bit 5	Bit 4	Bit 3	Bit 2	Bit 1	Bit 0
RFU	The indicator current $I_{INDICATOR}=I_{TORCH-TARGET}*((indicator\ current\ code+1)/128)$						

Note:

In Torch, Flash, or IR mode, the Register(0x69) value **Must be 0x00**(default), and the Indicator Current Register(0x39) value **Must be 0x7f**(default).

To set the indicator current level, the action must be done as follows:

- 1) Set the Register(0x69) value to 0x02, enable the indicator current setting.
- 2) Set the Indicator Current Register(0x39) value to the desired value.
- 3) Set the Register(0x69) value to 0x00(default), disable the indicator current setting.

APPLICATION INFORMATION

The AW36414 can drive two flash LEDs at currents up to 1.5 A per LED. The 2MHz/4MHz DC-DC boost regulator allows for the use of small value discrete external components. Below are some peripheral selection guidelines.

OUTPUT CAPACITOR SELECTION

The AW36414 is designed to operate with a 10μF ceramic output capacitor. When the boost converter is running, the output capacitor supplies the load current during the boost converter on-time. When the NMOS switch turns off, the inductor energy is discharged through the internal PMOS switch, supplying power to the load and restoring charge to the output capacitor. This causes a sag in the output voltage during the on-time and a rise in the output voltage during the off-time. The output capacitor is therefore chosen to limit the output ripple to an acceptable level depending on load current and input/output voltage differentials and also to ensure the converter remains stable.

Larger capacitors such as a 22μF or capacitors in parallel can be used if lower output voltage ripple is desired. To estimate the output voltage ripple considering the ripple due to capacitor discharge (ΔV_Q) and the ripple due to the capacitors ESR (ΔV_{ESR}) use the following equations:

For continuous conduction mode, the output voltage ripple due to the capacitor discharge is:

$$\Delta V_Q = \frac{(V_{OUT} - V_{IN}) \times I_{LED}}{V_{OUT} \times f \times C_{OUT}}$$

The output voltage ripple due to the output capacitors ESR is found by:

$$\Delta V_{ESR} = R_{ESR} \times \left(\frac{V_{OUT} \times I_{LED}}{V_{IN}} + \frac{\Delta I_L}{2} \right) \quad \text{Where} \quad \Delta I_L = \frac{V_{IN} \times (V_{OUT} - V_{IN})}{V_{OUT} \times f \times L}$$

In ceramic capacitors the ESR is very low so the assumption is that 80% of the output voltage ripple is due to capacitor discharge and 20% from ESR. Table 1 lists different manufacturers for various output capacitors and their case sizes suitable for use with the AW36414.

INPUT CAPACITOR SELECTION

Choosing the correct size and type of input capacitor helps minimize the voltage ripple caused by the switching of the AW36414 boost converter and reduce noise on the boost converter's input pin that can feed through and disrupt internal analog signals. In the typical application circuit a 10-μF ceramic input capacitor works well. It is important to place the input capacitor as close as possible to the AW36414 input (IN) pin. This reduces the series resistance and inductance that can inject noise into the device due to the input switching currents. Table 1 lists various input capacitors recommended for use with the AW36414.

Table 1 Recommended Input/ Output Capacitors (X5R/X7R Dielectric)

MANUFACTURER	PART NUMBER	VALUE	CASE	VOLTAGE RATING
TDK	C1608JB0J106M	10μF	0603	6.3V
TDK	C2012JB1A106M	10μF	0805	10V
Murata	GRM188R60J106M	10μF	0603	6.3V
Murata	GRM21BR61A106KE19	10μF	0805	10V

INDUCTOR SELECTION

The AW36414 is designed to use a 0.47μH or 1μH inductor. When the device is boosting ($V_{OUT} > V_{IN}$) the inductor is typically the largest area of efficiency loss in the circuit. Therefore, choosing an inductor with the lowest possible series resistance is important. Additionally, the saturation rating of the inductor should be greater than the maximum operating peak current of the AW36414. This prevents excess efficiency loss that can occur with inductors that operate in saturation. For proper inductor operation and circuit performance, ensure that the inductor saturation and the peak current limit setting of the AW36414 are greater than I_{PEAK} in the following calculation:

$$I_{PEAK} = \frac{I_{LED} \times V_{OUT}}{\eta \times V_{IN}} + \Delta I_L \quad \text{where} \quad \Delta I_L = \frac{V_{IN} \times (V_{OUT} - V_{IN})}{2 \times f_{SW} \times L \times V_{OUT}}$$

And f_{SW} = 2 or 4MHz.

Table 2 lists various inductors and their manufacturers that work well with the AW36414.

Table 2 Recommended Inductors

MANUFACTURER	L	PART NO.	SIZE	IsAT	R _{Dc}
TOKO	1μH	DFE201610P-1R0M	2.0 mm x 1.6 mm x 1.0 mm	3.7A	58mΩ
TOKO	0.47μH	DFE201610P-R470M	2.0 mm x 1.6 mm x 1.0 mm	4.1A	32mΩ
Sunlord	1μH	WPN252012H1R0MT	2.5mm x 2.0mm x1.2mm	3.4A	48mΩ

PCB LAYOUT

LAYOUT GUIDELINES

The high switching frequency and large switching currents of the AW36414 make the choice of layout important. The following steps should be used as a reference to ensure the device is stable and maintains proper LED current regulation across its intended operating voltage and current range.

1. Place C_{IN} on the top layer (same layer as the AW36414) and as close to the device as possible. The input capacitor conducts the driver currents during the low-side MOSFET turn-on and turn-off and can detect current spikes over 1 A in amplitude. Connecting the input capacitor through short, wide traces to both the IN and GND pins reduces the inductive voltage spikes that occur during switching which can corrupt the V_{IN} line.
2. Place C_{OUT} on the top layer (same layer as the AW36414) and as close as possible to the OUT and GND pin. The returns for both C_{IN} and C_{OUT} should come together at one point, as close to the GND pin as possible. Connecting C_{OUT} through short, wide traces reduce the series inductance on the OUT and GND pins that can corrupt the V_{OUT} and GND lines and cause excessive noise in the device and surrounding circuitry.
3. Connect the inductor on the top layer close to the SW pin. There should be a low-impedance connection from the inductor to SW due to the large DC inductor current, and at the same time the area occupied by the SW node should be small so as to reduce the capacitive coupling of the high dV/dT present at SW that can couple into nearby traces.
4. Avoid routing logic traces near the SW node so as to avoid any capacitive coupling from SW onto any high-impedance logic lines such as TORCH/TEMP, STROBE, HWEN, SDA, and SCL. A good approach is to insert an inner layer GND plane underneath the SW node and between any nearby routed traces. This creates a shield from the electric field generated at SW.
5. Terminate the Flash LED cathodes directly to the GND pin of the AW36414. If possible, route the LED returns with a dedicated path so as to keep the high amplitude LED currents out of the GND plane. For Flash LEDs that are routed relatively far away from the AW36414, a good approach is to sandwich the forward and return current paths over the top of each other on two layers. This helps reduce the inductance of the LED current paths.

PACKAGE DESCRIPTION

TOP VIEW

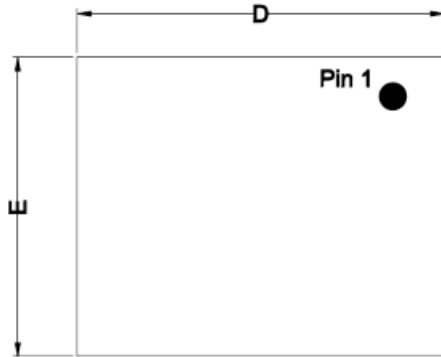

BOTTOM VIEW

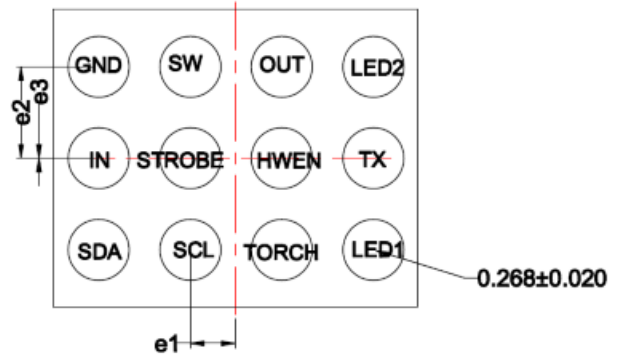

SIDE VIEW

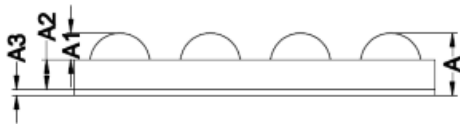

Symbol	NOM	Tolerance
A	0.575	±0.055
A1	0.195	±0.020
A2	0.340	±0.025
A3	0.040	±0.010
D	1.626	±0.025
E	1.332	±0.025
e1	0.196	NA
e2	0.400	NA
e3	0	NA

LAND PATTERN

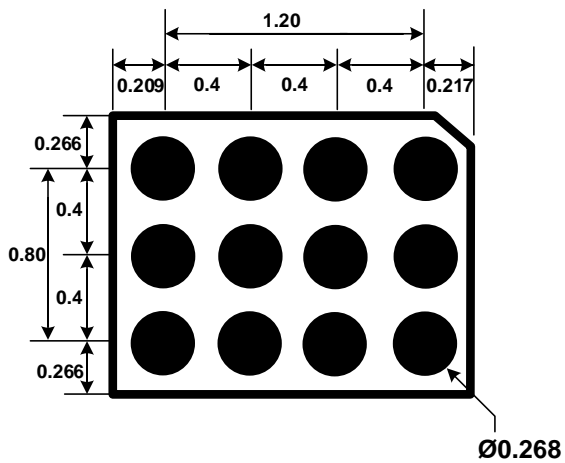

CARRIER

Product Spec (UNIT:mm)									
Spec	W	P1	E	F	D0	D1	P0	P2	10P0
Size	8.00 ^{+0.30} _{-0.10}	4.0±0.1	1.75±0.1	3.5±0.05	1.5 ^{+0.10} ₀	0.50±0.10	4.0±0.1	2±0.05	40±0.2
Spec	A0	A1	B0	B1	K0	K1	T		
Size	1.50±0.05		1.78±0.05		0.78±0.05		0.20±0.03		

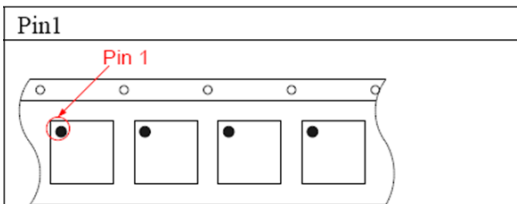
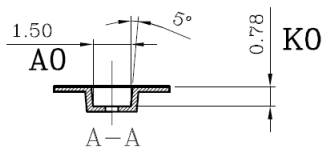
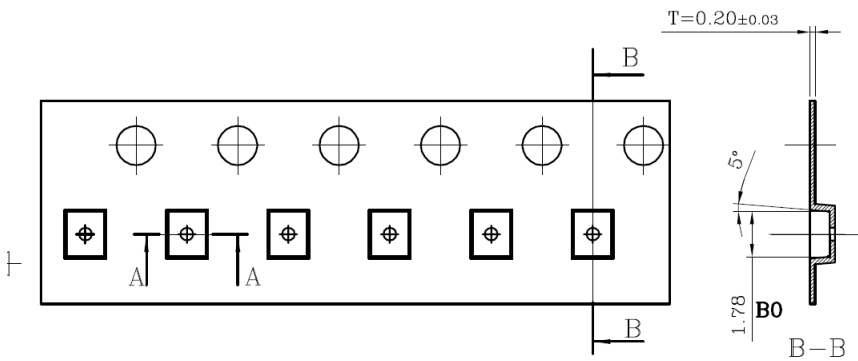
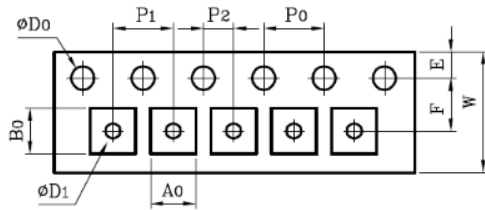

TAPE & REEL

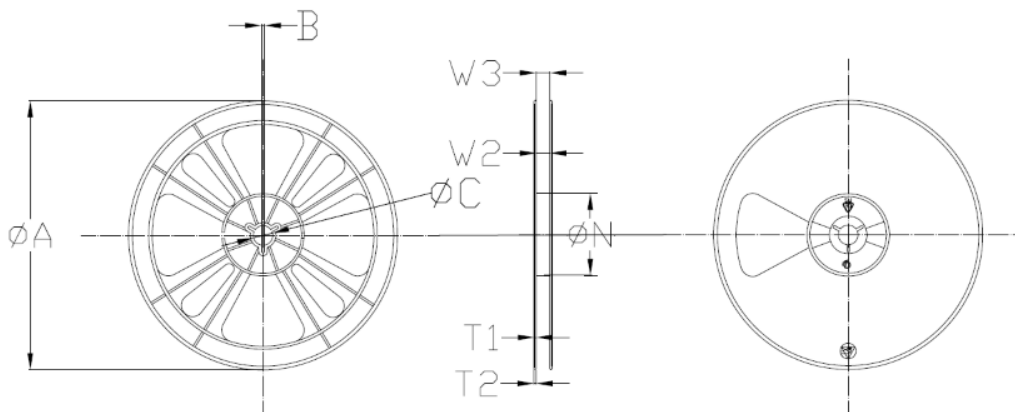

Item	Value&Tolerance
A	179±1.0
B	2.0±0.1
C	13.5±0.2
N	54.8±0.2
W2	9.0±0.2
W3	9.2±1.0
T1	1.2±0.2
T2	1.5±0.2

Note:

1. surface resistivity: 10^5 to 10^{11} ohms/sq.
2. Restriction criterion of hazardous substance for packing material follow GP-M001.

REFLOW PROFILE

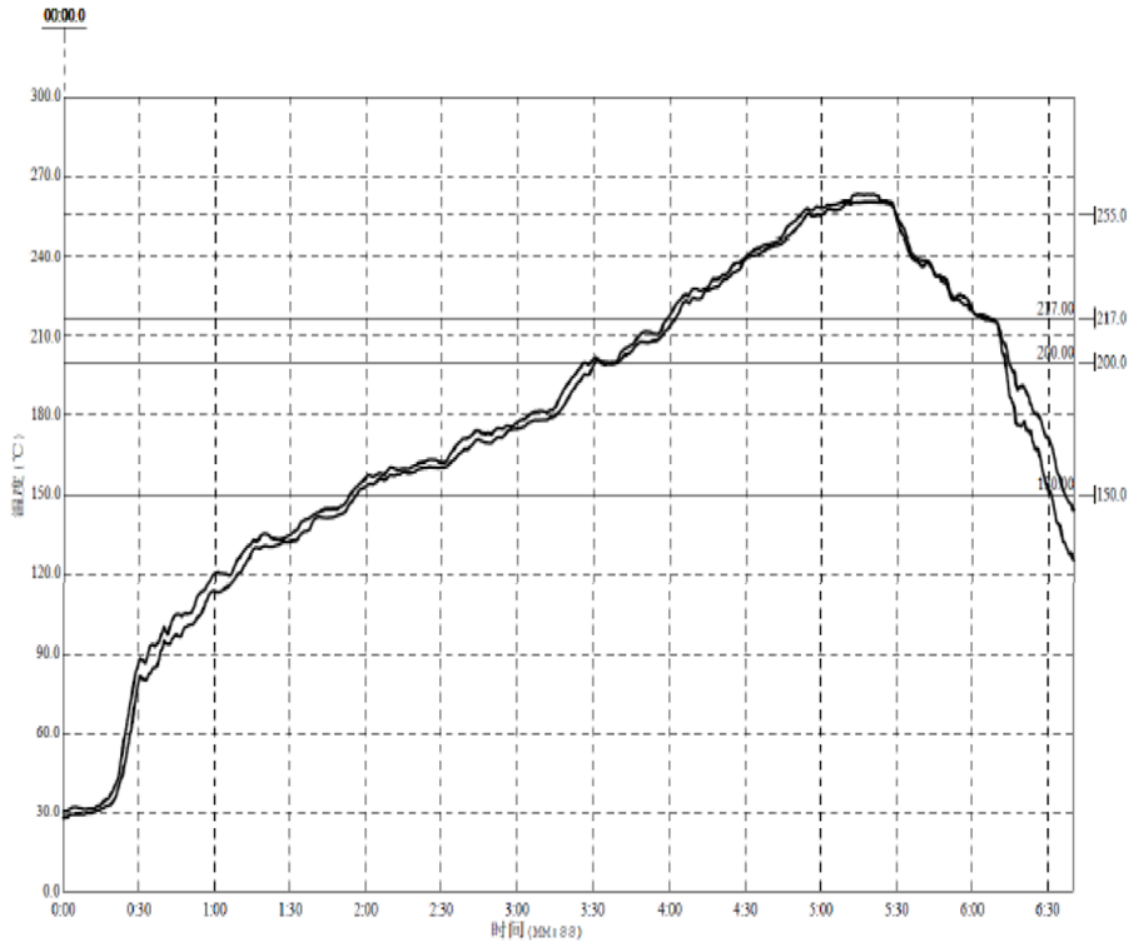

Reflow Note	Spec
Average ramp-up rate (217°C to Peak)	Max. 3°C/sec
Time of Preheat temp.(from 150°C to 200°C)	60-120sec
Time to be maintained above 217°C	60-150sec
Peak Temperature	>260°C
Time within 5°C of actual peak temp	20-40sec.
Ramp-down rate	Max. 6°C/sec
Time from 25°C to peak temp	Max. 8min.

REVISION HISTORY

Vision	Date	Change Record
V1.0	Jan 2017	Product Datasheet V1.0 Released
V1.1	Jan 2017	Modify the Top Mark Description --page2
V1.2	May 2017	Added HWEN & I ² C Interface Description --page17

DISCLAIMER

Information in this document is believed to be accurate and reliable. However, Shanghai AWINIC Technology Co., Ltd (AWINIC Technology) does not give any representations or warranties, expressed or implied, as to the accuracy or completeness of such information and shall have no liability for the consequences of use of such information.

AWINIC Technology reserves the right to make changes to information published in this document, including without limitation specifications and product descriptions, at any time and without notice. Customers shall obtain the latest relevant information before placing orders and shall verify that such information is current and complete. This document supersedes and replaces all information supplied prior to the publication hereof.

AWINIC Technology products are not designed, authorized or warranted to be suitable for use in medical, military, aircraft, space or life support equipment, nor in applications where failure or malfunction of an AWINIC Technology product can reasonably be expected to result in personal injury, death or severe property or environmental damage. AWINIC Technology accepts no liability for inclusion and/or use of AWINIC Technology products in such equipment or applications and therefore such inclusion and/or use is at the customer's own risk.

Applications that are described herein for any of these products are for illustrative purposes only. AWINIC Technology makes no representation or warranty that such applications will be suitable for the specified use without further testing or modification.

All products are sold subject to the general terms and conditions of commercial sale supplied at the time of order acknowledgement.

Nothing in this document may be interpreted or construed as an offer to sell products that is open for acceptance or the grant, conveyance or implication of any license under any copyrights, patents or other industrial or intellectual property rights.

Reproduction of AWINIC information in AWINIC data books or data sheets is permissible only if reproduction is without alteration and is accompanied by all associated warranties, conditions, limitations, and notices. AWINIC is not responsible or liable for such altered documentation. Information of third parties may be subject to additional restrictions.

Resale of AWINIC components or services with statements different from or beyond the parameters stated by AWINIC for that component or service voids all express and any implied warranties for the associated AWINIC component or service and is an unfair and deceptive business practice. AWINIC is not responsible or liable for any such statements.