

Inductorless, Four Channel Flash & Indicator 2in1 LED Driver

FEATURES

- Flash and Indicator 2in1 application
- Dual Independent 1.0A LED1/LED2 Current Source
 - Flash: 3.91mA~1.0A, 256 levels
3.91mA/level
 - Torch: 1.46mA~375mA, 256 levels
1.46mA/level
 - Indicator: 0.37mA~375mA, 1024 levels
0.37mA/level
 - Flash Timeout: 40ms~1.6s, 16 levels
- Dual Independent 375 mA LED3/LED4 Current Sink
 - Flash: 1.46mA~375mA, 256 levels
1.46mA/level
 - Torch: 1.46mA~375mA, 256 levels
1.46mA/level
 - Indicator: 0.73mA~375mA, 512 levels
0.73mA/level
 - Flash Timeout: 40ms~1.6s, 16 levels
- Optimized Flash LED Current During Low Battery Conditions (IVFM)
- Hardware Strobe Enable (STROBE)
- 400kHz I²C: AW36529 (I²C Address=0x63)
- 0.4mm Pitch, FCQFN-10L Package

APPLICATION

Smartphone Camera Flash

TYPICAL APPLICATION CIRCUIT

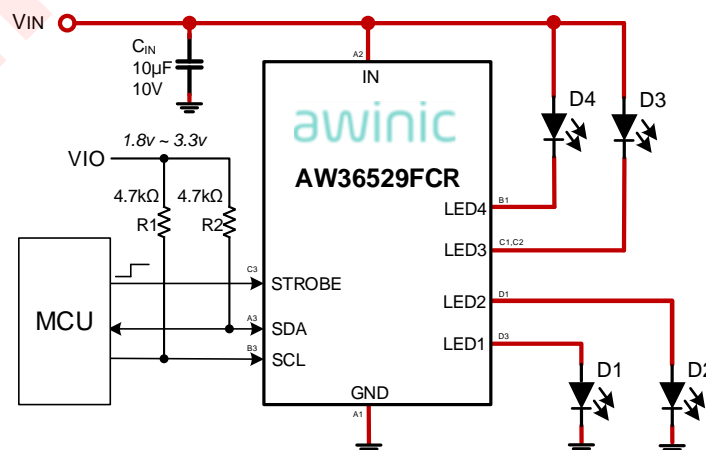

Fig 1 Typical Application Circuit of AW36529

GENERAL DESCRIPTION

The AW36529 is a inductorless four channel flash & Indicator 2in1 LED driver that provides a high level of adjustability within a ultra-small solution size. The AW36529 includes two current sources and two current sinks which are controlled independently by I²C-compatible interface. The AW36529 provides IVFM protection mode to prevent system reset or shutdown under low battery condition.

The AW36529 is controlled via an I²C-compatible interface. The main features of the AW36529 include: flash / torch / IR / Indicator current, flash timeout duration, IVFM and breath features. The AW36529 also provides hardware flash pin (STROBE) to control flash event.

The device operates over a -40°C to +85°C ambient temperature range.

The AW36529 is available in small 0.4mm pitch 1.6mmx1.2mm FCQFN-10L package.

PIN CONFIGURATION AND TOP MARK

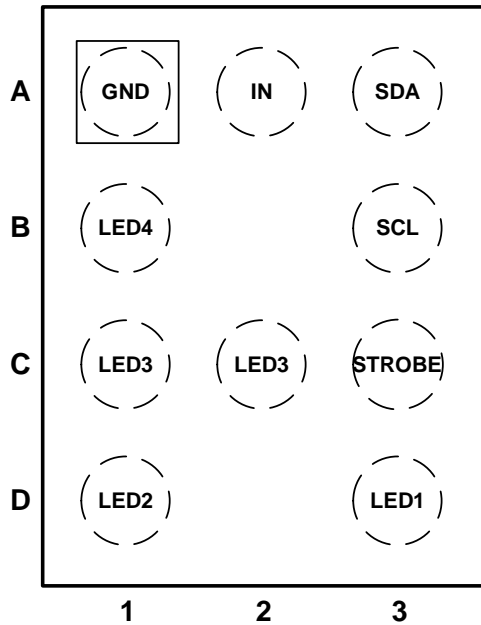
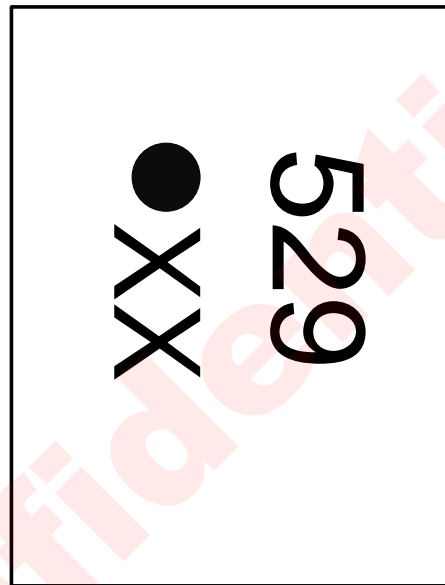
AW36529FCR Pin Configuration
(Top View)AW36529FCR Top Mark
(Top View)

529 – AW36529FCR

XX – Manufacture Tracking Code

Fig 2 Pin Configuration and Top Mark

PIN DEFINITION

No.	NAME	TYPE	DESCRIPTION
A1	GND	Ground	Ground
A2	IN	Power	Input voltage connection. Connect IN to GND with a 10 μ F or larger ceramic capacitor.
A3	SDA	I/O	Serial data input/output of the I ² C interface.
B1	LED4	I/O	Low-side current sink output for flash LED4.
B3	SCL	I/O	Serial clock input of the I ² C interface.
C1,C2	LED3	Power	Low-side current sink output for flash LED3.
C3	STROBE	I/O	Active high hardware flash enable. Drive STROBE high to turn on Flash pulse. Internal pull down resistor of 300k Ω between STROBE and GND.
D1	LED2	Power	High-side current source output for flash LED2.
D3	LED1	Power	High-side current source output for flash LED1.

ORDERING INFORMATION

Part Number	Temperature	Package	Marking	Moisture Sensitivity Level	Environmental Information	Delivery Form
AW36529FCR	-40°C~85°C	FCQFN-10L	529	MSL1	ROHS+HF	3000 units/ Tape and Reel

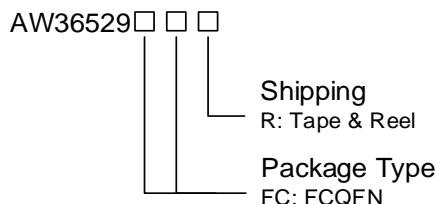

AWINIC FLASH LED DRIVER SERIES

Product	Channels	Type	Description	Package
AW3644	2	Boost	High Efficiency, Dual Independent 1.5A Flash LED Driver	CSP-12
AW36414	2	Boost	High Efficiency, Dual Independent 1.5A Flash LED Driver	CSP-12
AW3643	2	Boost	High Efficiency, Dual 1.5A Flash LED Driver	CSP-12
AW36413	2	Boost	High Efficiency, Dual 1.5A Flash LED Driver	CSP-12
AW3648	1	Boost	High Efficiency, 1.5A Flash LED Driver	CSP-12
AW3641E	1	Charge Pump	Flash Current & Flash Timer Programmable 1A Flash LED Driver	DFN-10
AW3640	1	Current Sink	200mA 1-Wire Configurable Front Flash LED Driver	DFN-6
AW36402	1	Current Sink	200mA 1-wire Configurable Front Flash LED Driver	DFN-6
AW36404	1	Current Sink	400mA 1-wire Configurable Front Flash LED Driver	DFN-8
AW36406	1	Current Sink	600mA PWM Configurable Front Flash LED Driver	DFN-8

TYPICAL APPLICATION CIRCUITS

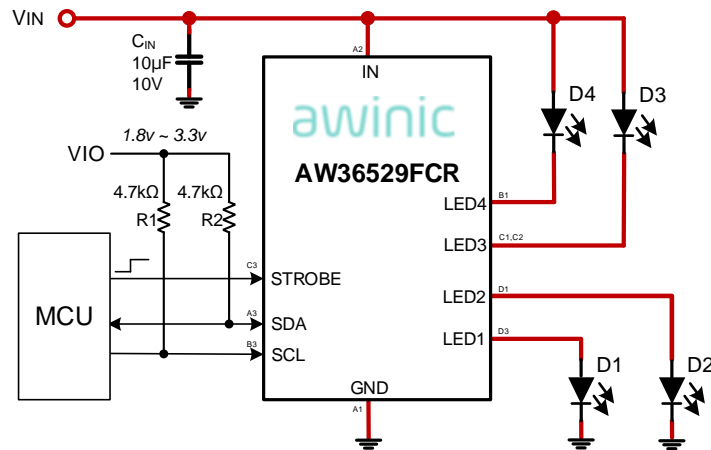

Fig 3 AW36529 Application Circuit

Notice for Typical Application Circuits:

1. Please place C_{IN} as close to the chip as possible.
2. For the sake of driving capability, the power lines, and the connection lines of LED should be short and wide as possible.

ABSOLUTE MAXIMUM RATINGS^(NOTE1)

PARAMETERS		Range	Unit
IN, LED1, LED2, LED3, LED4		-0.3 to 6	V
SCL, SDA, STROBE		-0.3 to (V _{IN} +0.3)	V
Continuous power dissipation		Internally limited	
Max Junction Temperature T _{JMAX}		155	°C
Storage Temperature T _{STG}		-65 to 150	°C
Maximum lead temperature (soldering)		260	°C
Junction to Ambient Thermal Resistance θ_{JA}		92	°C/W
ESD, All Pins ^(NOTE2)	HBM	±2000	V
	MM	±200	V
	CDM	±2000	V
Latch-Up JEESD78D		+IT: +350 -IT: -350	mA

RECOMMENDED OPERATING CONDITIONS

PARAMETERS	Range	Unit
V _{IN}	2.7 to 5.5	V
Junction temperature (T _J)	-40 to 125	°C
Ambient temperature (T _A)	-40 to 85	°C

NOTE1: Conditions out of those ranges listed in "absolute maximum ratings" may cause permanent damages to the device. In spite of the limits above, functional operation conditions of the device should within the ranges listed in "recommended operating conditions". Exposure to absolute-maximum-rated conditions for prolonged periods may affect device reliability.

NOTE2: The human body model is a 100pF capacitor discharged through a 1.5kΩ resistor into each pin. Test method: MIL-STD-883J Method 3015.9

ELECTRICAL CHARACTERISTICS

Typical limits tested at $T_A=25^{\circ}\text{C}$. Minimum and maximum limits apply over the full operating ambient temperature range ($-40^{\circ}\text{C}\leq T_A\leq 85^{\circ}\text{C}$). Unless otherwise specified, $V_{IN}=3.8\text{V}$.

Symbol	Description	Test Condition	Min	Typ	Max	Unit
Vin Supply						
V_{IN}	Input Operating Range		2.7		5.5	V
I_{SB}	Standby Supply Current	$2.7\text{V}\leq V_{IN}\leq 5.5\text{V}$, $SCL=SDA=0\text{V}$		1	2	μA
I_Q	Quiescent Supply Current			0.2	0.5	mA
UVLO	Under Voltage Lockout Threshold	Falling V_{IN}		2.5		V
		Rising V_{IN}		2.6		V
Current Source Specifications						
$I_{LED1/2}$	Current Source Accuracy	Flash Code=0xFF=1.0A	-10%	1	10%	A
		Torch Code=0x7F=187.5mA	-10%	187.5	10%	mA
$I_{LED3/4}$	Current Source Accuracy	Flash Code =0xFF=400mA	-10%	400	10%	mA
		Torch Code=0x7F=200mA	-10%	200	10%	mA
$V_{HR_LED1/2}$	Headroom Voltage of LED1/2	Flash Code=0xFF=1.0A		200	300	mV
		Torch Code=0x7F=187.5mA		50	75	mV
$V_{HR_LED3/4}$	Headroom Voltage of LED3/4	Flash Code =0xFF=375mA		180	270	mV
		Torch Code=0x7F=187.5mA		90	135	mV
T_{FLASH}	Flash Time-out Duration	Reg 0x0B, bits[3:0]="1010"	-5%	600	5%	ms
V_{IVFM}	Input Voltage Flash Monitor Trip Threshold	Reg 0x02, bits[3:1]="000"	-3%	2.9	3%	V
T_{SD}	Thermal Shutdown Threshold			155		$^{\circ}\text{C}$
	Thermal Shutdown Hysteresis			20		
I²C-Compatible Interface Specifications(SCL,SDA)						
V_{IL}	Input Logic Low		0		0.4	V
V_{IH}	Input Logic High		1.2		V_{IN}	V
V_{OL}	Output Logic Low	$I_{LOAD}=3\text{mA}$			0.4	V
STROBE Voltage Specifications						
V_{IL}	Input Logic Low		0		0.4	V
V_{IH}	Input Logic High		1.2		V_{IN}	V
R_{PD}	Internal Pull Down Resistors			300		k Ω

I²C INTERFACE TIMING

Symbol	Description	Min	Typ	Max	Units
F _{SCL}	Interface Clock Frequency			400	kHz
T _{DEGLITCH}	Deglitch Time	SCL	200		ns
		SDA	250		ns
T _{HD:STA}	(Repeat-Start) Start Condition Hold Time	0.6			μs
T _{LOW}	Low Level Width of SCL	1.3			μs
T _{HIGH}	High Level Width of SCL	0.6			μs
T _{SU:STA}	(Repeat-Start) Start Condition Setup Time	0.6			μs
T _{HD:DAT}	Data Hold Time	0			μs
T _{SU:DAT}	Data Setup Time	0.1			μs
T _R	Rising Time of SDA And SCL			0.3	μs
T _F	Falling Time of SDA And SCL			0.3	μs
T _{SU:STO}	Stop Condition Setup Time	0.6			μs
T _{BUF}	Time Between Start and Stop Condition	1.3			μs

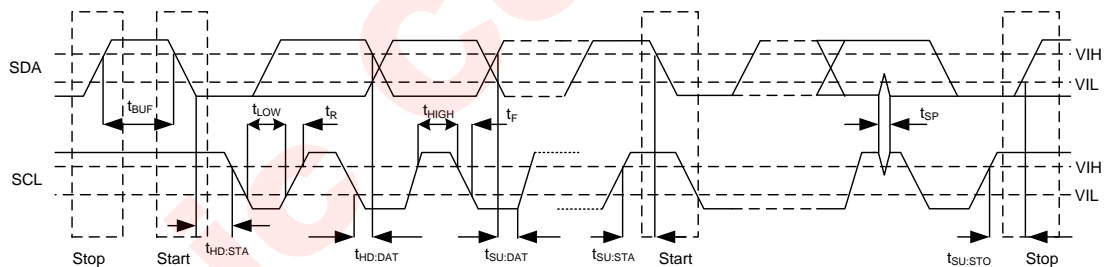
Fig 4 I²C INTERFACE TIMING

TYPICAL CHARACTERISTICS

$T_a=25^{\circ}\text{C}$, $V_{\text{IN}}=3.8\text{V}$, $V_{\text{LED}}=2.9\text{V}$ @ 375mA, IVFM=Off, unless otherwise noted .

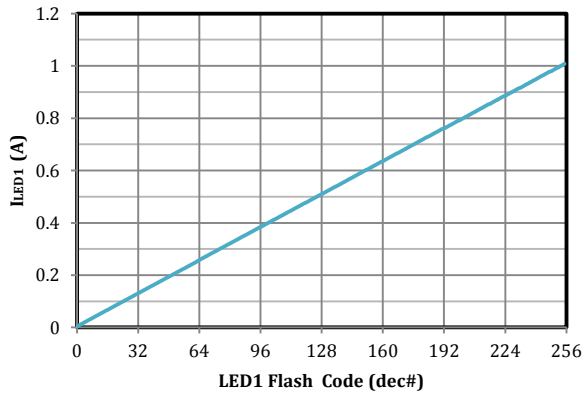

Fig5. LED1 Flash Current vs Brightness Code

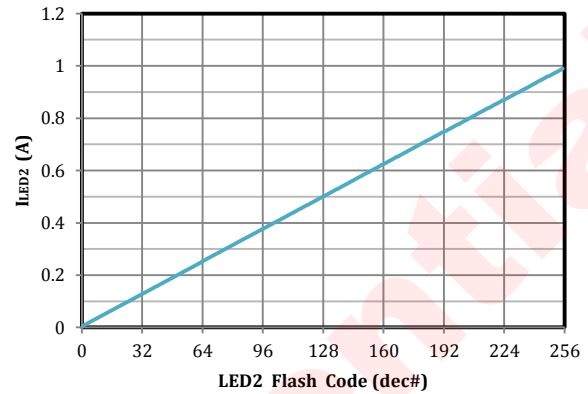

Fig6. LED2 Flash Current vs Brightness Code

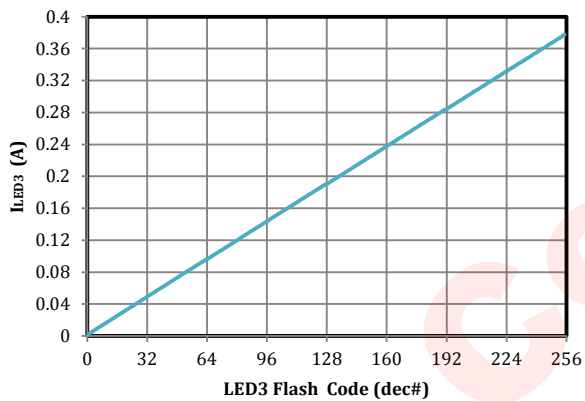

Fig7. LED3 Flash Current vs Brightness Code

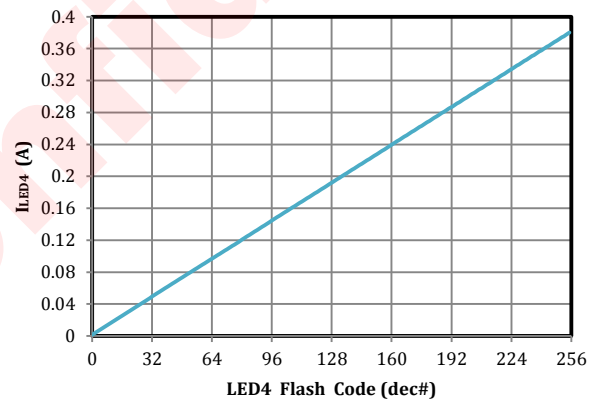

Fig8. LED4 Flash Current vs Brightness Code

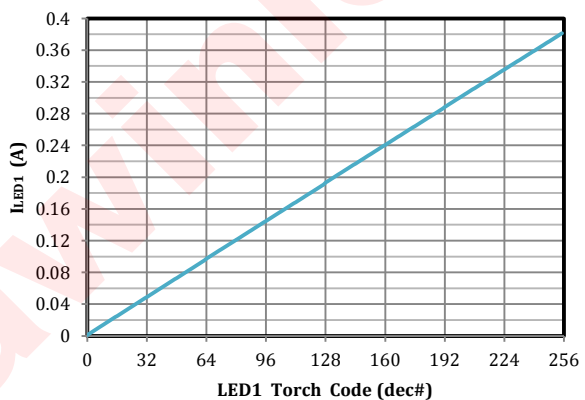

Fig9. LED1 Torch Current vs Brightness Code

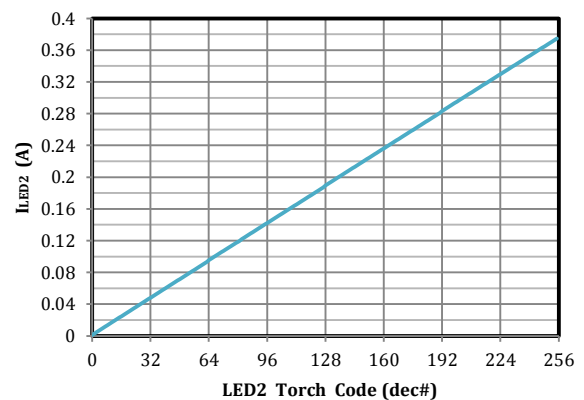

Fig10. LED2 Torch Current vs Brightness Code

Typical Characteristics (continued)

Ta=25°C, V_{IN}=3.8V, V_{LED}=2.9V @ 375mA, IVFM=Off, unless otherwise noted .

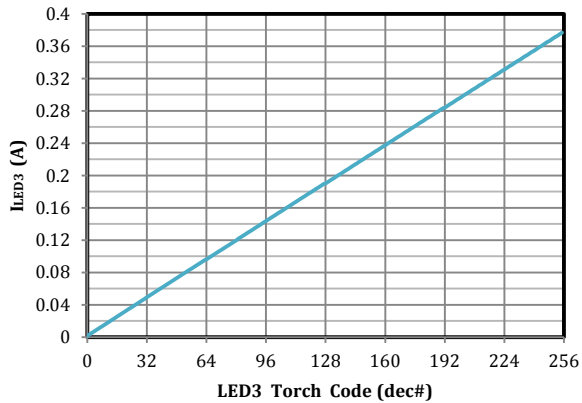

Fig11. LED3 Torch Current vs Brightness Code

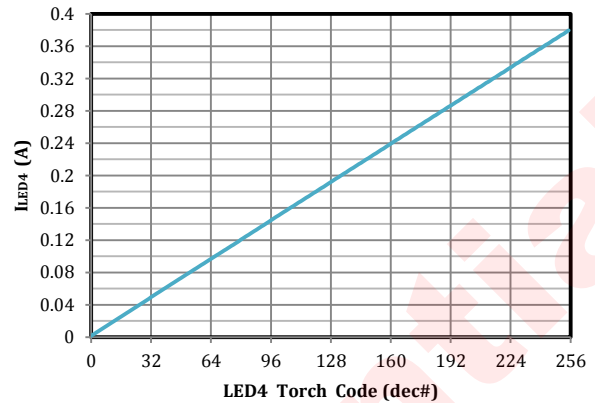

Fig12. LED4 Torch Current vs Brightness Code

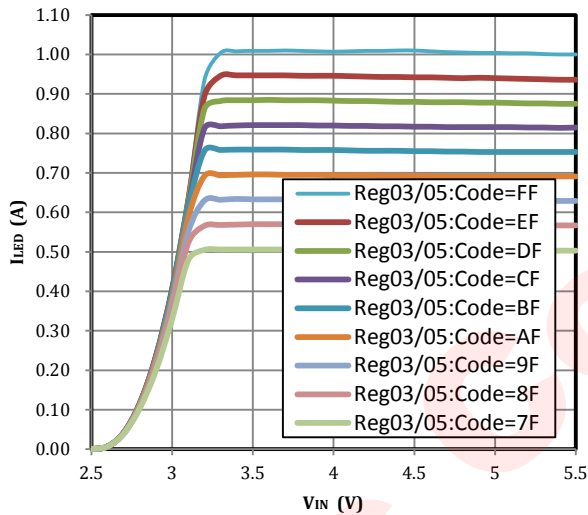

Fig13. LED1/2 Flash Current vs Input Voltage

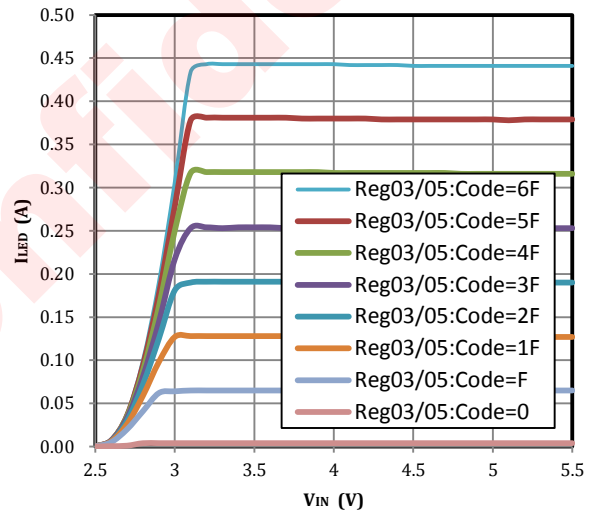

Fig14. LED1/2 Flash Current vs Input Voltage

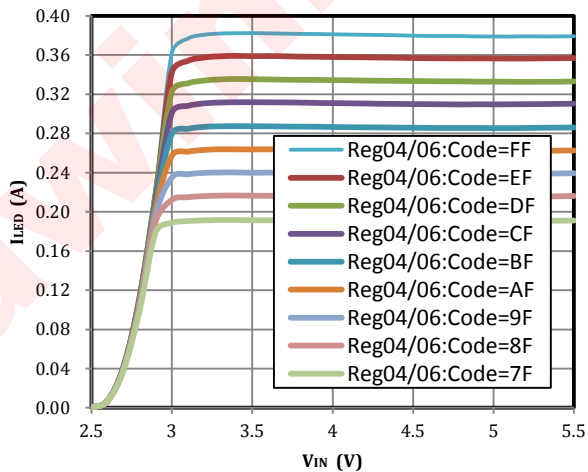

Fig15. LED1/2 Torch Current vs Input Voltage

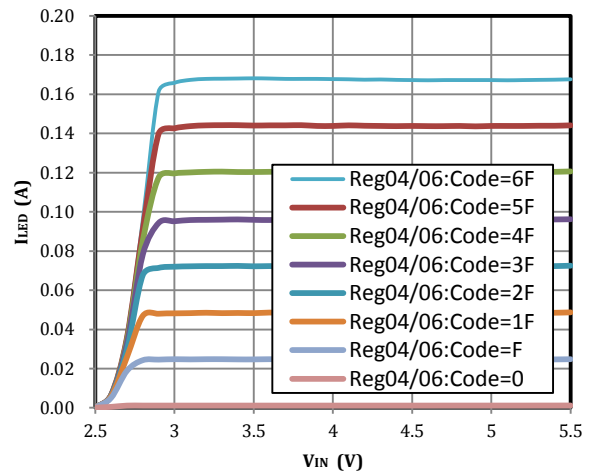

Fig16. LED1/2 Torch Current vs Input Voltage

Typical Characteristics (continued)

Ta=25°C, V_{IN}=3.8V, V_{LED}=2.9V @ 375mA, IVFM=Off, unless otherwise noted .

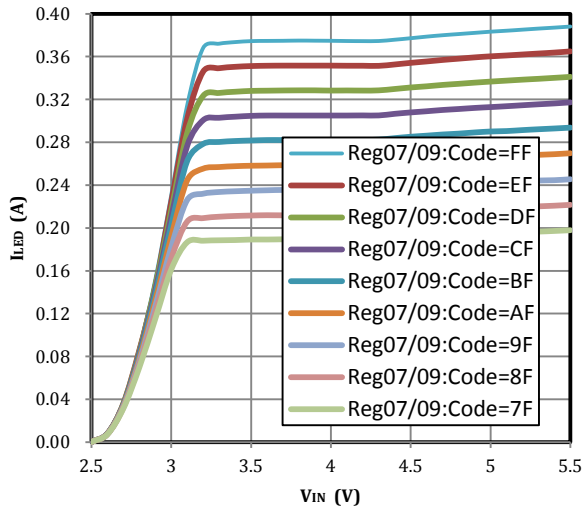

Fig17. LED3/4 Flash Current vs Input Voltage

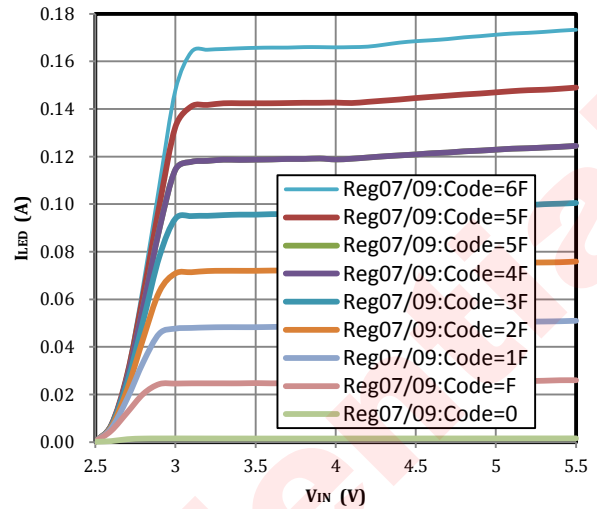

Fig18. LED3/4 Flash Current vs Input Voltage

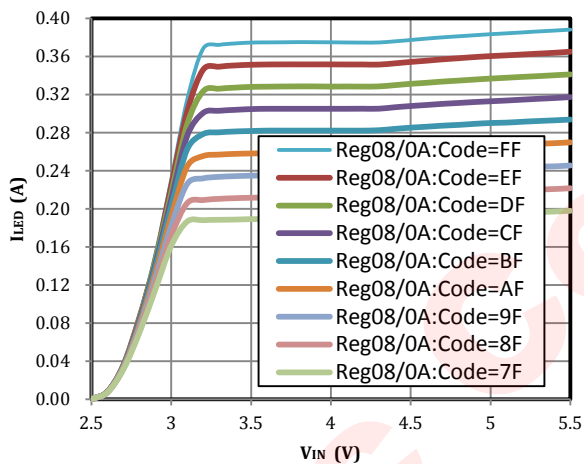

Fig19. LED3/4 Torch Current vs Input Voltage

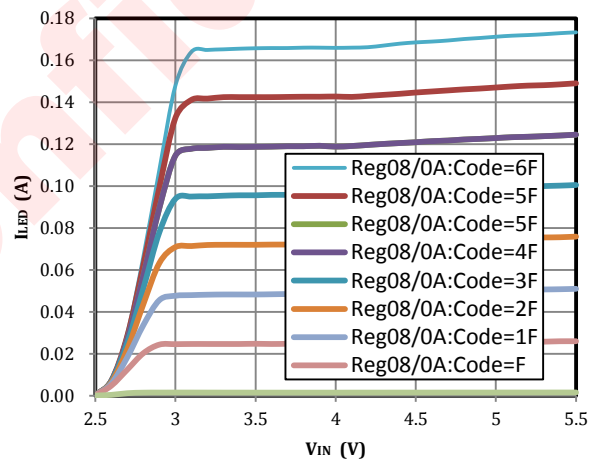

Fig20. LED3/4 Torch Current vs Input Voltage

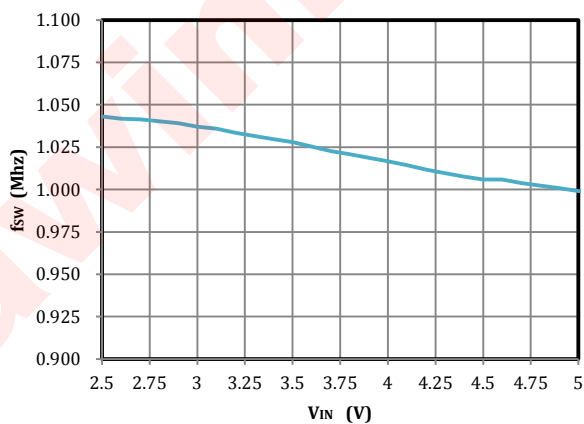

Fig 21. Oscillator Frequency vs Input Voltage

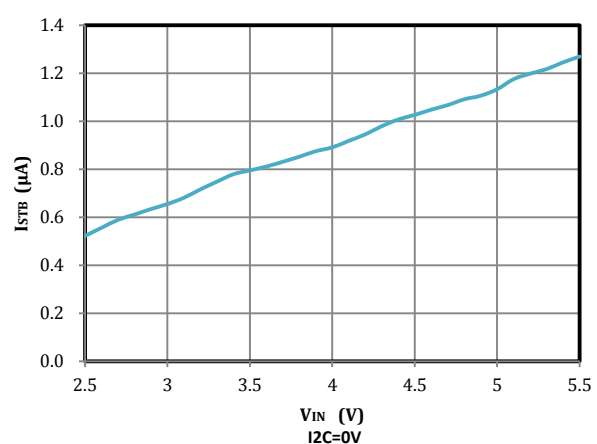

Fig 22. Standby Current vs Input Voltage

Typical Characteristics (continued)

Ta=25°C, V_{IN}=3.8V, V_{LED}=2.9V @ 375mA, IVFM=Off, unless otherwise noted .

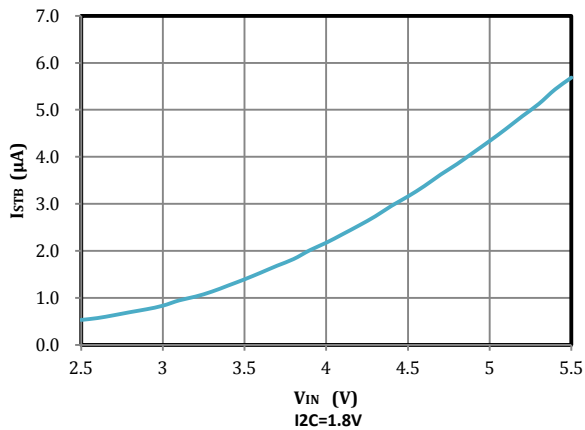

Fig 23. Standby Current vs Input Voltage

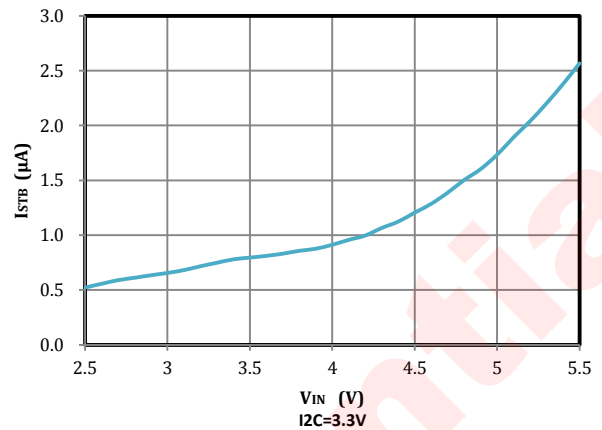
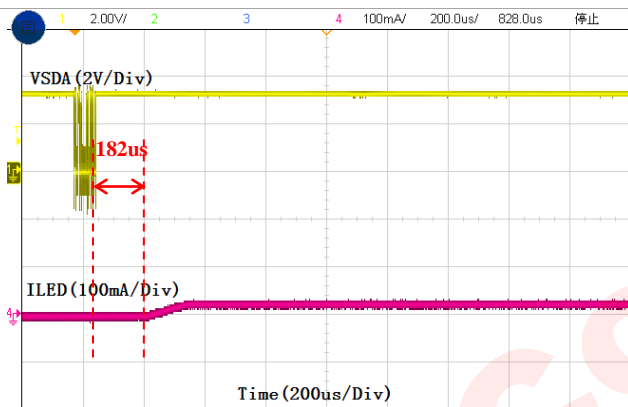
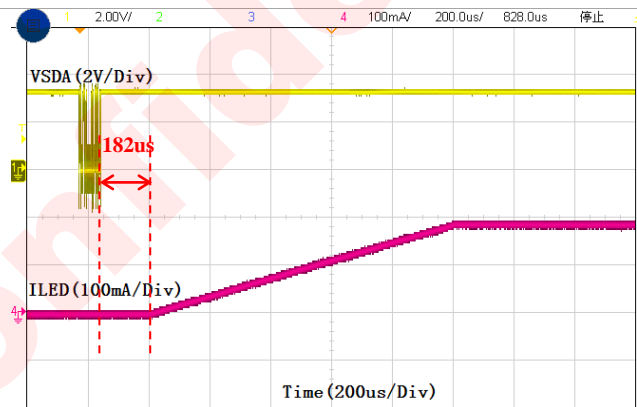

Fig 24. Standby Current vs Input Voltage



I_{LED}=187.5mA, V_{IN}=3.5V, IVFM=3.6V

Fig 25. IVFM ON



I_{LED}=187.5mA, V_{IN}=3.5V, IVFM=3.6V

Fig 26. IVFM OFF

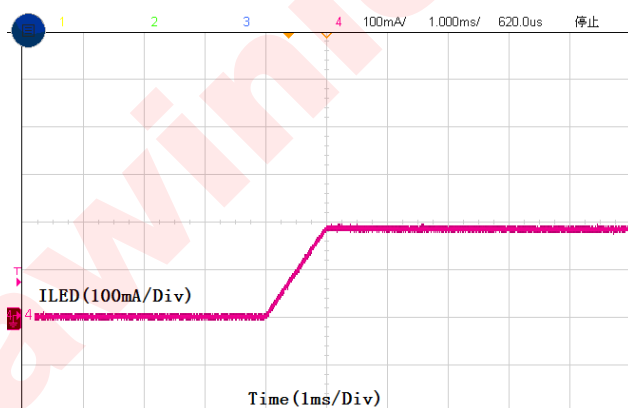

I_{LED}=187.5mA

Fig 27. Flash Ramp up time

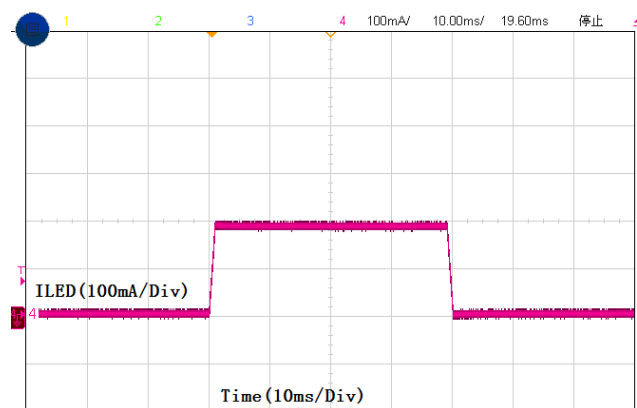

I_{LED}=187.5mA Timeout=40ms(Reg0B(3:0)=0000)

Fig 28. Flash time out

Typical Characteristics (continued)

$T_a=25^{\circ}\text{C}$, $V_{IN}=3.8\text{V}$, $V_{LED}=2.9\text{V}$ @ 375mA, IVFM=Off, unless otherwise noted .

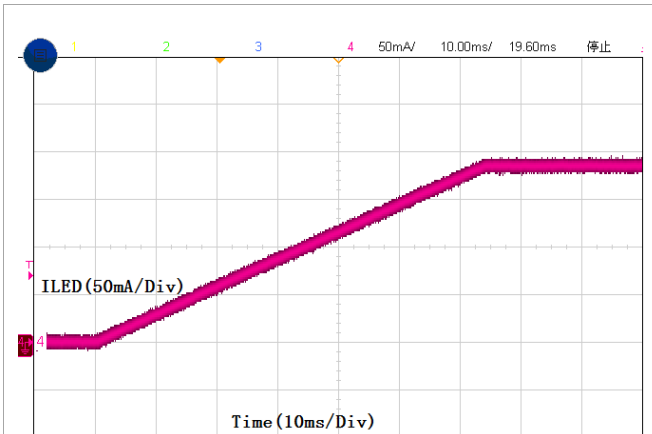

ILED=187.5mA Torch Ramp up=64ms(Reg0B(7:4)=0011)

Fig 29. Torch Ramp up time

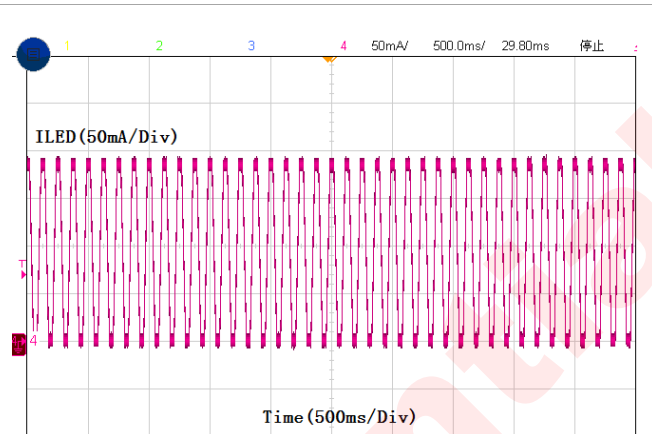

ILED=187.5mA Continuous breathing(Reg0E(7:4)=0000)

Indicator: RU=32ms, On= 64ms, RD=32ms, OFF=64ms.

Fig 30. Indicator unstop mode

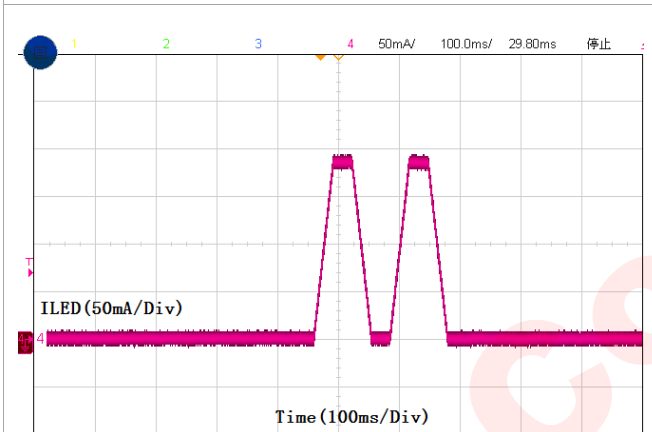

ILED=187.5mA breath twice(Reg0E(7:4)=0010)

Indicator: RU=32ms, On= 64ms, RD=32ms, OFF=64ms.

Fig 31. Indicator 2 times

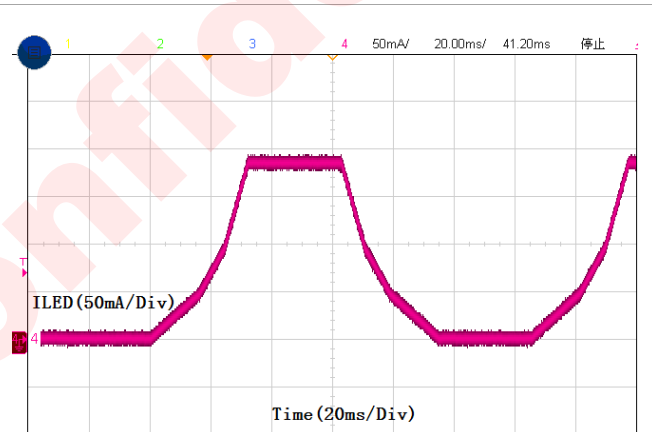

ILED=187.5mA log mode

Indicator: RU=32ms, On= 64ms, RD=32ms, OFF=64ms.

Fig 32. Indicator log mode

DETAILED FUNCTIONAL DESCRIPTION

The AW36529 is a high-power four-channel LED flash driver capable of delivering up to 1.0A in either of the two source LEDs and up to 0.375A in either of the two sink LEDs over the 2.7V to 5.5V input voltage range.

The device has one logic input for a hardware flash enable (STROBE). This logic input has an internal 300k Ω (typical) pull-down resistor to GND.

The device is controlled via an I²C-compatible interface which includes adjustment of the Flash and Torch current levels, changing the Flash Timeout Duration, IVFM level and breath features. Additionally, there are flag and status bits that indicate flash current timeout, LED over-temperature condition, LED failure (short), device thermal shutdown, and V_{IN} under-voltage conditions.

Additional features of the device include an automatically forced LED1/2 and LED3/4 enable mutually exclusive to avoid the OTP occurred when all four LEDs are ON. The function can be set by bit7 in the IVFM Register(0x02).

FUNCTION BLOCK DIAGRAM

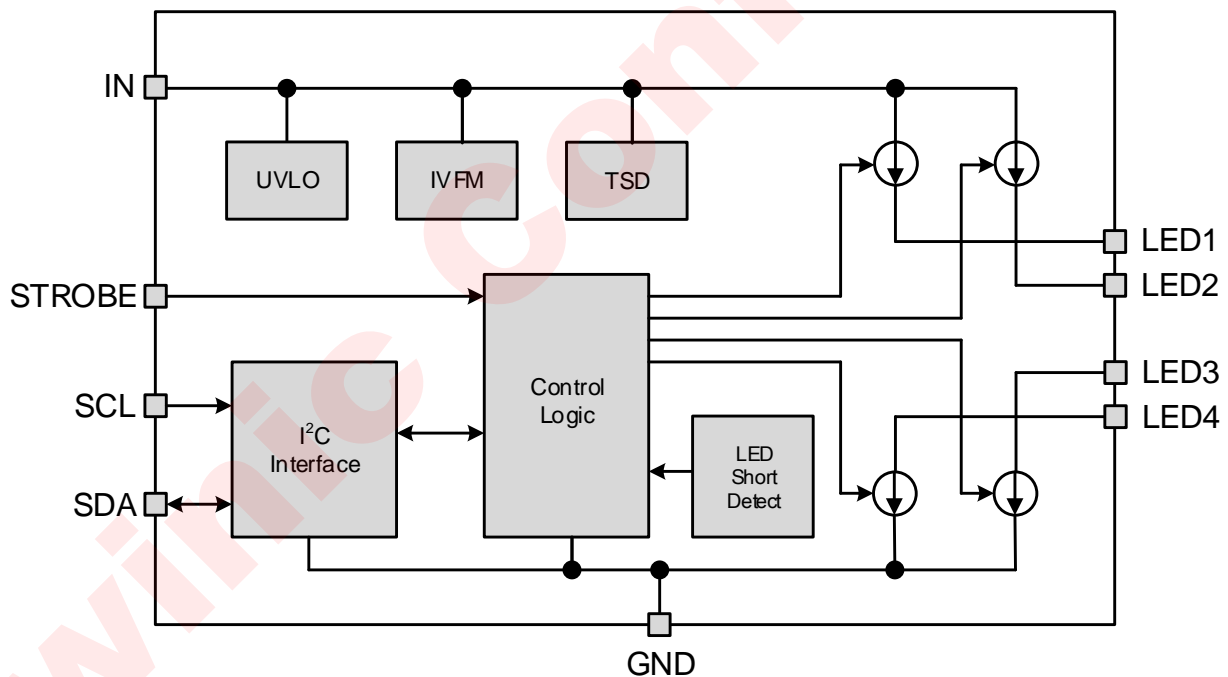

FEATURE DESCRIPTION

FLASH MODE

In Flash Mode, the LED current sources (LED1/2) provide 256 target current levels from 3.9mA to 1.0A and the LED current sinks(LED3/4) provide 256 target current levels from 1.46mA to 375mA. The Flash currents are adjusted via the LED1,LED2,LED3 and LED4 Flash Brightness Registers. Flash mode is activated by the Enable Register(setting M1, M0 to '11'), or by pulling the STROBE pin HIGH when the pin is enabled (Enable Register). Once the Flash sequence is activated, the current sources (LED1/2) and the current sinks (LED3/4) ramp up to the programmed Flash current by stepping through all current steps until the programmed current is reached.

When the device is enabled in Flash Mode through the Enable Register, all mode bits in the Enable Register are cleared after a flash timeout event.

TORCH MODE

In Torch mode, the LED current sources (LED1/2) provide 256 target current levels from 1.46mA to 375mA and the LED current sinks(LED3/4) provide 256 target current levels from 1.46mA to 375mA. The Torch currents are adjusted via the LED1,LED2,LED3 and LED4 Torch Brightness Registers. Torch mode is activated by the Enable Register (setting M1, M0 to '10'). Once the TORCH sequence is activated, the active current sources (LED1/2) and the current sinks (LED3/4) ramp up to the programmed Torch current by stepping through all current steps until the programmed current is reached. The rate at which the current ramps is determined by the value chosen in the Flash & Torch Timing Register (0x0B 7:4). Torch Mode is not affected by Flash Timeout.

IR MODE

In IR Mode, the target LED current is equal to the value stored in the LED1/2/3/4 Flash Brightness Registers. When IR mode is enabled (setting M1, M0 to '01'), toggling the STROBE pin enables and disables the LED1/2 current sources and LED3/4 current sinks (if enabled). The strobe pin can only be set to be Level sensitive, meaning all timing of the IR pulse is externally controlled. In IR Mode, the current sources do not ramp the LED outputs to the target. The current transitions immediately from off to on and then on to off.

INPUT VOLTAGE FLASH MONITOR (IVFM)

The AW36529 has the ability to adjust the flash current based upon the voltage level present at the IN pin utilizing the Input Voltage Flash Monitor (IVFM). The adjustable threshold ranges from 2.9 V to 3.6 V in 100mV steps, with hold mode. The IVFM threshold are controlled by bits[3:0] in the IVFM Register(0x02). The Flags Register has the IVFM flag bit set when the input voltage crosses the IVFM threshold value and after 4us deglitch delay. Additionally, the IVFM threshold sets the input voltage boundary that forces the AW36529 to either stop ramping the flash current after 32 steps ramp up during the startup.

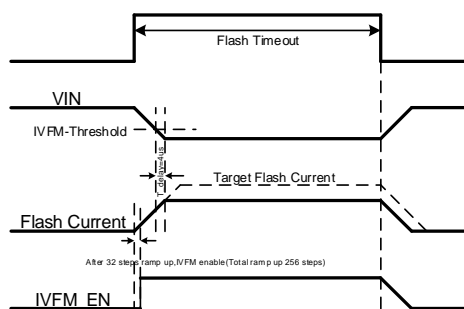

Fig 33 IVFM Timing

FLASH TIMEOUT

The Flash Timeout period sets the maximum time of one flash event, whether a flash stop command is received or not. The AW36529 has 16 timeout levels ranging from 40ms to 1.6s (see Flash & Torch TIMING CONFIGURATION REGISTER (0X0B) for more detail). Flash Timeout applies to both Flash and IR modes. The mode bits are cleared and bit[0] is set in the Flags register(0x0F) upon a Flash Timeout. This fault flag can be reset to '0' by reading back the Flags Register (0x0F), or by removing power to the AW36529.

UNDERVOLTAGE LOCKOUT (UVLO)

The AW36529 has an internal comparator that monitors the voltage at IN and forces the AW36529 into standby when the input voltage drops to 2.5 V. If the UVLO monitor threshold is tripped, the UVLO flag bit is set in the Flags Register (0x0F). If the input voltage rises above 2.5 V, the AW36529 is not available for operation until there is an I²C read of the Flags Register (0x0F). Upon a read, the Flags register is cleared, and normal operation can resume if the input voltage is greater than 2.5 V.

LED SHORT FAULT

The LED Short Fault flags read back a '1' if the device is active in Flash or Torch or IR or Indicator mode and either active LED output experiences a short condition. An LED short condition is determined if the voltage at LED1 or LED2 goes below 500mV (typ.) or the voltage between VIN and LED3 or LED4 less than 520mV(typ.) while the device is in Flash or Torch or IR or Indicator mode. There is a deglitch time of 256μs before the LED Short Fault flag is valid. The mode bits are cleared upon an LED short fault. The AW36529 is not available for operation until the LED Short Fault flags is cleared. The LED Short Faults can be reset to '0' by reading back the Flags Register (0x0F), or by removing power to the AW36529.

THERMAL SHUTDOWN (TSD)

When the AW36529 die temperature reaches 155°C, the thermal shutdown detection circuit is trips, forcing the AW36529 into standby and writing a '1' to the Thermal Shutdown Fault flag of the Flags Register (0x0F) . The AW36529 is only allowed to restart after the Thermal Shutdown Fault flag is cleared. The Thermal Shutdown Faults can be reset to '0' by reading back the Flags Register (0x0F), or by removing power to the AW36529. Upon restart, if the die temperature is still above 155°C, the AW36529 resets the Fault flag and re-enters standby.

PROGRAMMING

I²C INTERFACE

Data Validation

When SCL is high level, SDA level must be constant. SDA can be changed only when SCL is low level.

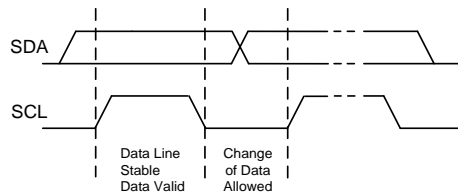

Fig 34 Data Validation Diagram

I²C Start/Stop

I²C start: SDA changes from high level to low level when SCL is high level.

I²C stop: SDA changes from low level to high level when SCL is high level.

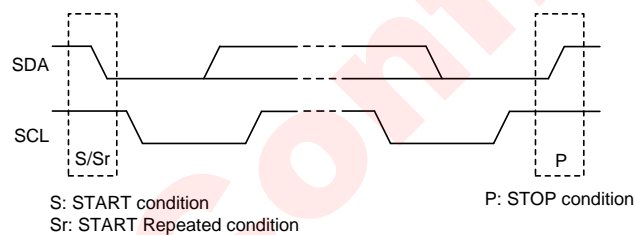

Fig 35 Start and Stop Conditions

ACK (Acknowledgement)

ACK means the successful transfer of I²C bus data. After master sends 8bits data, SDA must be released; SDA is pulled to GND by slave device when slave acknowledges.

When master reads, slave device sends 8bit data, releases the SDA and waits for ACK from master. If ACK is send and I²C stop is not send by master, slave device sends the next data. If ACK is not send by master, slave device stops to send data and waits for I²C stop.

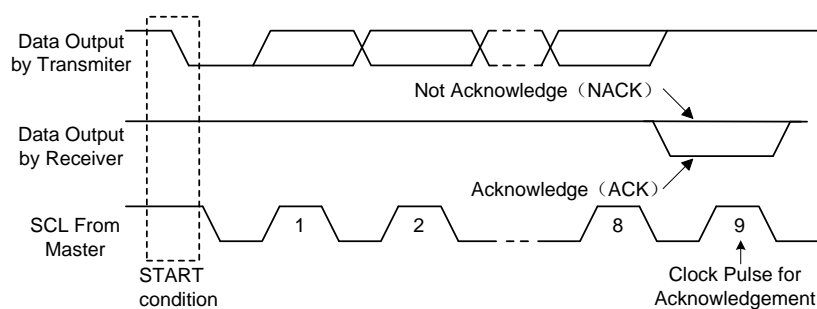

Fig 36 Acknowledgement Diagram

Write Cycle

One data bit is transferred during each clock pulse. Data is sampled during the high state of the serial clock (SCL). Consequently, throughout the clock's high period, the data should remain stable. Any changes on the SDA line during the high state of the SCL and in the middle of a transaction, aborts the current transaction. New data should be sent during the low SCL state. This protocol allows a single data line to transfer both command/control information and data using the synchronous serial clock.

Each data transaction is composed of a Start Condition, a number of byte transfers (set by the software) and a Stop Condition to terminate the transaction. Every byte written to the SDA bus must be 8 bits long and is transferred with the most significant bit first. After each byte, an Acknowledge signal must follow.

In a write process, the following steps should be followed:

- 1) Master device generates START condition. The "START" signal is generated by lowering the SDA signal while the SCL signal is high.
- 2) Master device sends slave address (7-bit) and the data direction bit (R/W = 0).
- 3) Slave device sends acknowledge signal if the slave address is correct.
- 4) Master sends control register address (8-bit)
- 5) Slave sends acknowledge signal
- 6) Master sends data byte to be written to the addressed register
- 7) Slave sends acknowledge signal
- 8) If master will send further data bytes the control register address will be incremented by one after acknowledge signal (repeat step 6, 7)
- 9) Master generates STOP condition to indicate write cycle end



Fig 37 I²C Write Timing

Read Cycle

In a read cycle, the following steps should be followed:

- 1) Master device generates START condition
- 2) Master device sends slave address (7-bit) and the data direction bit (R/W = 0).
- 3) Slave device sends acknowledge signal if the slave address is correct.
- 4) Master sends control register address (8-bit)
- 5) Slave sends acknowledge signal
- 6) Master generates STOP condition followed with START condition or REPEAT START condition
- 7) Master device sends slave address (7-bit) and the data direction bit (R/W = 1).
- 8) Slave device sends acknowledge signal if the slave address is correct.
- 9) Slave sends data byte from addressed register.
- 10) If the master device sends acknowledge signal, the slave device will increase the control register

address by one, then send the next data from the new addressed register.

11) If the master device generates STOP condition, the read cycle is ended.

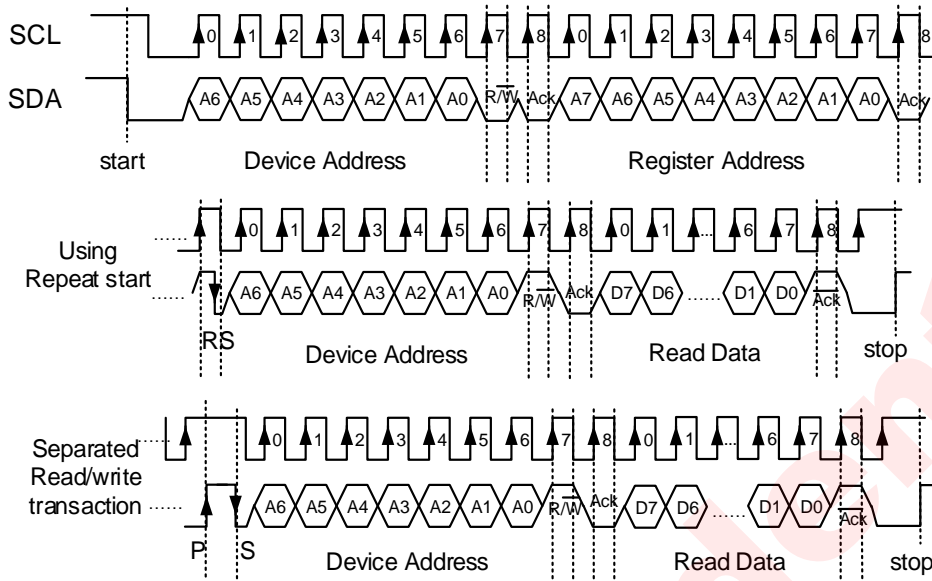

Fig 38 I²C Read Timing

REGISTER CONFIGURATION

REGISTER LIST

Register name	Address(HEX)	Read/Write	Default Value
Chip ID Register	0x00	Read	0x17
Enable Register	0x01	Read/Write	0x00
IVFM Register	0x02	Read/Write	0xE1
LED1 Flash Brightness Register	0x03	Read/Write	0x7F
LED1 Torch Brightness Register	0x04	Read/Write	0x7F
LED2 Flash Brightness Register	0x05	Read/Write	0x7F
LED2 Torch Brightness Register	0x06	Read/Write	0x7F
LED3 Flash Brightness Register	0x07	Read/Write	0x7F
LED3 Torch Brightness Register	0x08	Read/Write	0x7F
LED4 Flash Brightness Register	0x09	Read/Write	0x7F
LED4 Torch Brightness Register	0x0A	Read/Write	0x7F
Flash & Torch Timing Register	0x0B	Read/Write	0x1A
Indicator Timing1 Register	0x0C	Read/Write	0x77
Indicator Timing2 Register	0x0D	Read/Write	0x55
Indicator Control Register	0x0E	Read/Write	0x00
Flags Register	0x0F	Read	0x00
Device ID Register	0x10	Read	0xE7
Indicator Brightness Low Bits Register	0x11	Read/Write	0xFF

REGISTER DETAILED DESCRIPTION

◇ Chip ID Register (0x00) , default(0x17)

Bit 7	Bit 6	Bit 5	Bit 4	Bit 3	Bit 2	Bit 1	Bit 0
Chip ID: "0001 0111"							
Write 55H To Reset All Registers							

◇ Enable Register (0x01) , default(0x00)

Bit 7	Bit 6	Bit 5	Bit 4	Bit 3	Bit 2	Bit 1	Bit 0
Strobe Type 0=Level Triggered (Default) 1=Edge Triggered	Strobe Enable 0=Disabled (Default) 1=Enabled	Mode Bits: M1, M0 00=Standby (Default) 01=IR Drive 10=Torch 11=Flash		LED4 Enable 0=OFF (Default) 1=ON	LED3 Enable 0=OFF (Default) 1=ON	LED2 Enable 0=OFF (Default) 1=ON	LED1 Enable 0=OFF (Default) 1=ON

Note:

In Edge or Level Strobe Mode, it is recommended that the trigger pulse width be set greater than 1ms to ensure proper turn-on of the device.

◇ IVFM Register (0x02) , default(0xE1)

Bit 7	Bit 6	Bit 5	Bit 4	Bit 3	Bit 2	Bit 1	Bit 0
LEDX Enable Setting 0= if LED1 or LED2 is Enabled, LED3 & LED4 is Disabled Internally 1=No Limitation (Default)	LED3/4 Pin Short Fault Detect 0=Disabled 1=Enabled (Default)	LED1/2 Pin Short Fault Detect 0=Disabled 1=Enabled (Default)	UVLO Enable 0=Disabled (Default) 1=Enabled	IVFM Levels 000=2.9 V (Default) 001=3.0 V 010=3.1 V 011=3.2 V 100=3.3 V 101=3.4 V 110=3.5 V 111=3.6 V			IVFM Enable 0=Disabled 1=Enabled (Default)

◇ LED1 Flash Brightness Register (0x03) , default(0x7F)

Bit 7	Bit 6	Bit 5	Bit 4	Bit 3	Bit 2	Bit 1	Bit 0
LED1 Flash Brightness Levels $I_{FLASH}(mA) \approx (Brightness\ Code * 3.91mA) + 3.91mA$ 00000000=3.91 mA 01111111=500 mA (Default) 11111111=1.0 A							

◇ LED1 Torch Brightness Register (0x04) , default(0x7F)

Bit 7	Bit 6	Bit 5	Bit 4	Bit 3	Bit 2	Bit 1	Bit 0
LED1 Torch Brightness Levels $I_{TORCH}(mA) \approx (Brightness\ Code * 1.46mA) + 1.46mA$ 00000000=1.46 mA 01111111=187.5 mA (Default) 11111111=375 mA							

◇ LED2 Flash Brightness Register (0x05) , default(0x7F)

Bit 7	Bit 6	Bit 5	Bit 4	Bit 3	Bit 2	Bit 1	Bit 0
LED2 Flash Brightness Levels							
$I_{FLASH}(mA) \approx (Brightness\ Code * 3.91mA) + 3.91mA$							
00000000=3.91 mA							
01111111=500 mA (Default)							
11111111=1.0 A							

◇ LED2 Torch Brightness Register (0x06) , default(0x7F)

Bit 7	Bit 6	Bit 5	Bit 4	Bit 3	Bit 2	Bit 1	Bit 0
LED2 Torch Brightness Levels							
$I_{TORCH}(mA) \approx (Brightness\ Code * 1.46mA) + 1.46mA$							
00000000=1.46 mA							
01111111=187.5 mA (Default)							
11111111=375 mA							

◇ LED3 Flash Brightness Register (0x07) , default(0x7F)

Bit 7	Bit 6	Bit 5	Bit 4	Bit 3	Bit 2	Bit 1	Bit 0
LED3 Flash Brightness Levels							
$I_{TORCH}(mA) \approx (Brightness\ Code * 1.56mA) + 1.46mA$							
00000000=1.46 mA							
01111111=187.5 mA (Default)							
11111111=375 mA							

◇ LED3 Torch Brightness Register (0x08) , default(0x7F)

Bit 7	Bit 6	Bit 5	Bit 4	Bit 3	Bit 2	Bit 1	Bit 0
LED3 Torch Brightness Levels							
$I_{TORCH}(mA) \approx (Brightness\ Code * 1.56mA) + 1.46mA$							
00000000=1.46 mA							
01111111=187.5 mA (Default)							
11111111=375 mA							

◇ LED4 Flash Brightness Register (0x09) , default(0x7F)

Bit 7	Bit 6	Bit 5	Bit 4	Bit 3	Bit 2	Bit 1	Bit 0
LED4 Flash Brightness Levels							
$I_{TORCH}(mA) \approx (Brightness\ Code * 1.56mA) + 1.46mA$							
00000000=1.46 mA							
01111111=187.5 mA (Default)							
11111111=375 mA							

✧ LED4 Torch Brightness Register (0x0A) , default(0x7F)

Bit 7	Bit 6	Bit 5	Bit 4	Bit 3	Bit 2	Bit 1	Bit 0
LED4 Torch Brightness Levels							
$I_{TORCH}(mA) \approx (\text{Brightness Code} * 1.56mA) + 1.46mA$							
00000000=1.46 mA							
01111111=187.5 mA (Default)							
11111111=375 mA							

✧ Flash & Torch Timing Register (0x0B) , default(0x1A)

Bit 7	Bit 6	Bit 5	Bit 4	Bit 3	Bit 2	Bit 1	Bit 0
Torch Current Ramp time				Flash Time-out Duration			
0000=No Ramp				0000=40 ms			
0001=1 ms (Default)				0001=80 ms			
0010=32 ms				0010=120 ms			
0011=64 ms				0011=160 ms			
0100=128 ms				0100=200 ms			
0101=256 ms				0101=240 ms			
0110=384 ms				0110=280 ms			
0111=512 ms				0111=320 ms			
1000=768 ms				1000=360 ms			
1001=1024 ms				1001=400 ms			
1010=1280 ms				1010=600 ms (Default)			
1011=1536 ms				1011=800 ms			
1100=1792 ms				1100=1000 ms			
1101=2048 ms				1101=1200 ms			
1110=2048 ms				1110=1400 ms			
1111=2048 ms				1111=1600 ms			

✧ Indicator Timing1 Register (0x0C) , default(0x77)

Bit 7	Bit 6	Bit 5	Bit 4	Bit 3	Bit 2	Bit 1	Bit 0
Indicator Ramp Up Timing Setting				Indicator Ramp Down Timing Setting			
0000=No Ramp				0000=No Ramp			
0001=1 ms				0001=1 ms			
0010=32 ms				0010=32 ms			
0011=64 ms				0011=64 ms			
0100=128 ms				0100=128 ms			
0101=256 ms				0101=256 ms			
0110=384 ms				0110=384 ms			
0111=512 ms (Default)				0111=512 ms (Default)			
1000=768 ms				1000=768 ms			
1001=1024 ms				1001=1024 ms			
1010=1280 ms				1010=1280 ms			
1011=1536 ms				1011=1536 ms			
1100=1792 ms				1100=1792 ms			
1101=2048 ms				1101=2048 ms			
1110=2048 ms				1110=2048 ms			
1111=2048 ms				1111=2048 ms			

✧ Indicator Timing2 Register (0x0D) , default(0x55)

Bit 7	Bit 6	Bit 5	Bit 4	Bit 3	Bit 2	Bit 1	Bit 0
Indicator ON Timing Setting				Indicator OFF Timing Setting			
0000=64 ms				0000=64 ms			
0001=128 ms				0001=128 ms			
0010=256 ms				0010=256 ms			
0011=512 ms				0011=512 ms			
0100=768 ms				0100=768 ms			
0101=1024 ms (Default)				0101=1024 ms (Default)			
0110=1280 ms				0110=1280 ms			
0111=1536 ms				0111=1536 ms			

1000=1792 ms 1001=2048 ms 1010=2560 ms 1011=3072 ms 1100=3584 ms 1101=4096 ms 1110=4608 ms 1111=5120 ms	1000=1792 ms 1001=2048 ms 1010=2560 ms 1011=3072 ms 1100=3584 ms 1101=4096 ms 1110=4608 ms 1111=5120 ms
--	--

Note: Below is the indicator Timing sequence

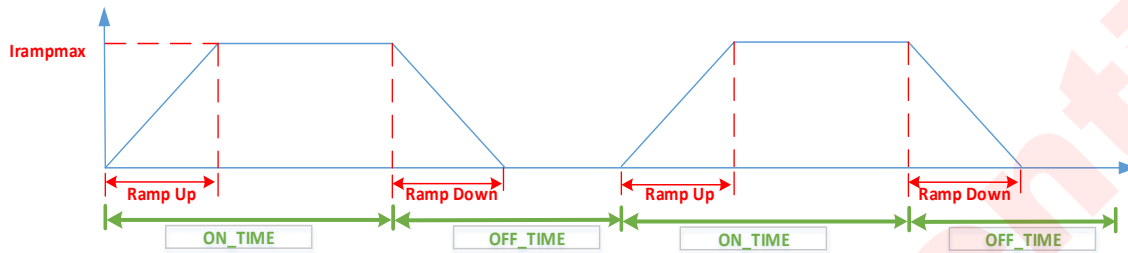

◇ Indicator Control Register (0x0E) , default(0x00)

Bit 7	Bit 6	Bit 5	Bit 4	Bit 3	Bit 2	Bit 1	Bit 0	
Breath Repeat Times 0000=Breath Continuously (Default) 0001=1 0010=2 0111=7 1111=15				Breath Ramp Type 0=Linear (Default) 1=Exponential		Indicator Status 00=Indicator Standby (Default) 01=Indicator Constant on 10=Chip Return to Standby when Breath is over 11= Chip Return to ON status when Breath is over		Indicator Enable 0=Disable (Default) 1=Enable

◇ Flags Register (0x0F) , default(0x00)

Bit 7	Bit 6	Bit 5	Bit 4	Bit 3	Bit 2	Bit 1	Bit 0
Flash Time-Out Flag	IVFM Trip Flag	LED4 Short Fault	LED3 Short Fault	LED2 Short Fault	LED1 Short Fault	Thermal Shutdown (TSD) Fault	UVLO Fault

◇ Device ID Register (0x10) , default(0xE7)

Bit 7	Bit 6	Bit 5	Bit 4	Bit 3	Bit 2	Bit 1	Bit 0
Device ID: "1110 0111"							

◇ Indicator Brightness Low Bits Register (0x11) , default(0xFF)

Bit 7	Bit 6	Bit 5	Bit 4	Bit 3	Bit 2	Bit 1	Bit 0
LED4 Indicator Brightness Levels Low bit	RFU	LED3 Indicator Brightness Levels Low bit	RFU	LED2 Indicator Brightness Levels Low bits		LED1 Indicator Brightness Levels Low bits	

PCB LAYOUT

LAYOUT GUIDELINES

The PCB layout of the high-power inductorless four channel LED driver AW36529 is important. The following steps should be used as a reference to ensure the device is stable and maintains proper LED current regulation across its intended operating voltage and current range.

1. Place CIN on the top layer (same layer as the AW36529) and as close to the device as possible. The input capacitor conducts the driver currents during LED1/LED2/LED3/LED4 turn on and can detect current spikes over 2.8A in amplitude. Connecting the input capacitor through short, wide traces to both the IN and GND pins reduces the inductive voltage spikes that occur during switching which can corrupt the VIN line.
2. For LED1/LED2, terminate the Flash LED cathodes directly to the GND pin of the AW36529. If possible, route the LED returns with a dedicated path so as to keep the high amplitude LED currents out of the GND plane. For Flash LEDs that are routed relatively far away from the AW36529, a good approach is to sandwich the forward and return current paths over the top of each other on two layers. This helps reduce the inductance of the LED current paths.
3. For LED3/LED4, terminate the Flash LED cathodes directly to the LED3/LED4 pin of the AW36529. If possible, route the LED returns with a dedicated path so as to keep the high amplitude LED currents out of the IN plane. For Flash LEDs that are routed relatively far away from the AW36529, a good approach is to sandwich the forward and return current paths over the top of each other on two layers. This helps reduce the inductance of the LED current paths.
4. To optimize the VIN operation range, the IN and GND wire should as short and wide as possible to reduce the series resistor. Meanwhile, To optimize the heat dissipation performance, the GND pins should be connected to the PCB ground plane using as many vias as possible.

PACKAGE DESCRIPTION

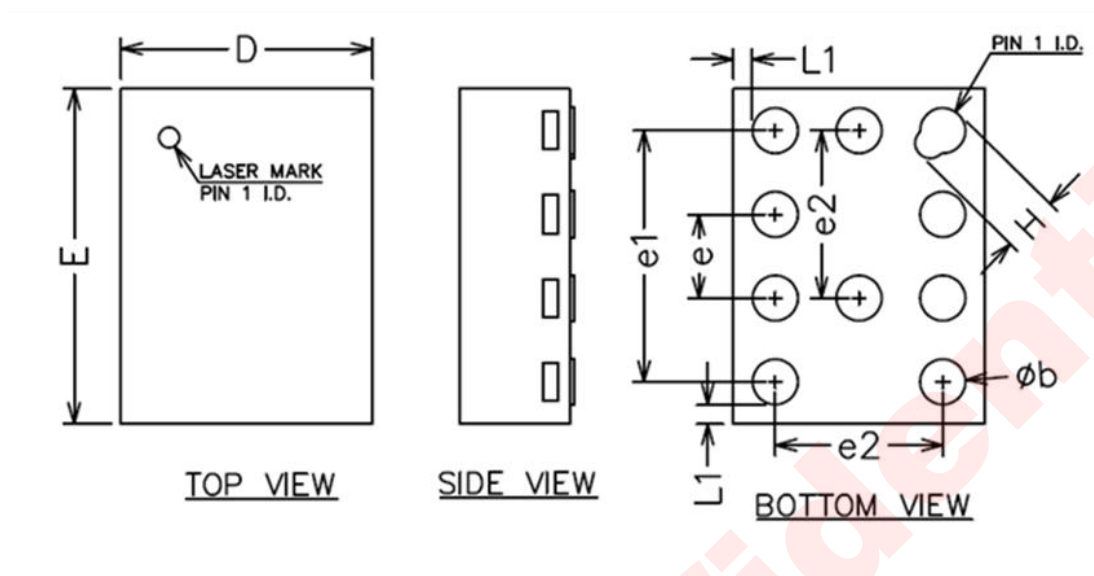
COMMON DIMENSIONS
(UNITS OF MEASURE=MILLIMETER)

SYMBOL	MIN	NOM	MAX
A	0.50	0.55	0.60
A1	0.00	0.02	0.05
A3	0.15REF		
b	0.17	0.22	0.27
D	1.10	1.20	1.30
E	1.50	1.60	1.70
e	0.40REF		
e1	1.20REF		
e2	0.80REF		
H	0.27REF		
L1	0.09REF		

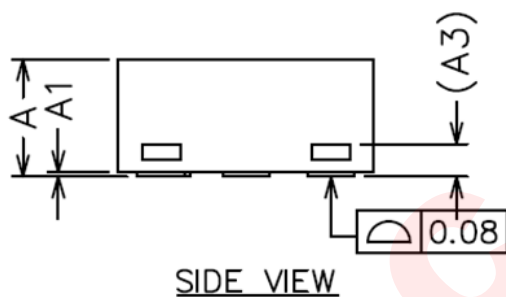

LAND PATTERN

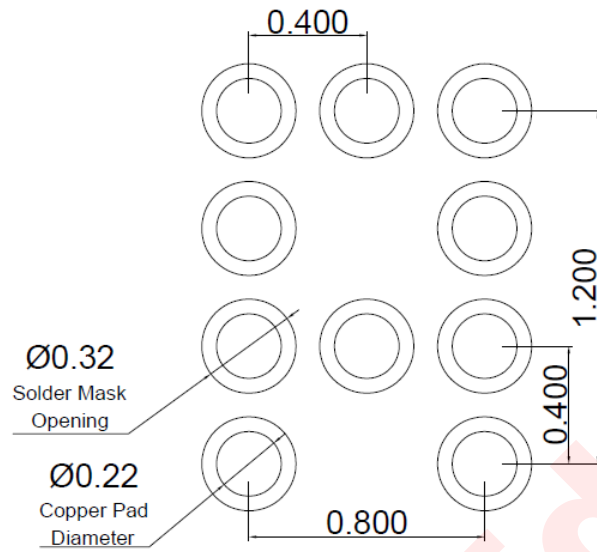

Dimensions are all in millimeters

REFLOW PROFILE

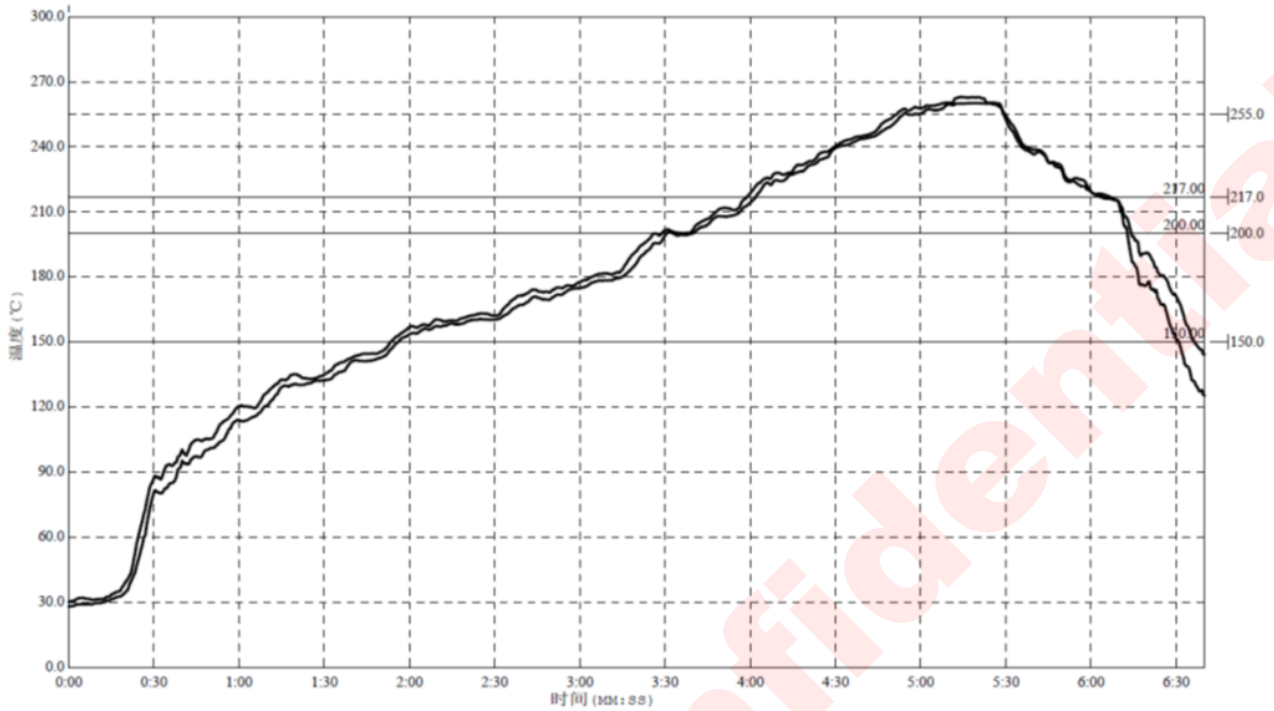

Reflow Note	Spec
Average ramp-up rate (217°C to peak)	Max. 3°C /sec
Time of Preheat temp. (from 150°C to 200°C)	60-120sec
Time to be maintained above 217°C	60-150sec
Peak Temperature	>260°C
Time within 5°C of actual peak temp	20-40sec
Ramp-down rate	Max. 6°C /sec
Time from 25°C to peak temp	Max. 8min

REVISION HISTORY

Version	Date	Change Record
V1.0	Oct 2017	Product Datasheet V1.0 Released
V1.1	Apr 2018	Product Datasheet V1.1 Released----add $V_{HR}(\max)$ value
V1.2	Sep 2018	Correction Package: FCQFN-10L

DISCLAIMER

Information in this document is believed to be accurate and reliable. However, Shanghai AWINIC Technology Co., Ltd (AWINIC Technology) does not give any representations or warranties, expressed or implied, as to the accuracy or completeness of such information and shall have no liability for the consequences of use of such information.

AWINIC Technology reserves the right to make changes to information published in this document, including without limitation specifications and product descriptions, at any time and without notice. Customers shall obtain the latest relevant information before placing orders and shall verify that such information is current and complete. This document supersedes and replaces all information supplied prior to the publication hereof.

AWINIC Technology products are not designed, authorized or warranted to be suitable for use in medical, military, aircraft, space or life support equipment, nor in applications where failure or malfunction of an AWINIC Technology product can reasonably be expected to result in personal injury, death or severe property or environmental damage. AWINIC Technology accepts no liability for inclusion and/or use of AWINIC Technology products in such equipment or applications and therefore such inclusion and/or use is at the customer's own risk.

Applications that are described herein for any of these products are for illustrative purposes only. AWINIC Technology makes no representation or warranty that such applications will be suitable for the specified use without further testing or modification.

All products are sold subject to the general terms and conditions of commercial sale supplied at the time of order acknowledgement.

Nothing in this document may be interpreted or construed as an offer to sell products that is open for acceptance or the grant, conveyance or implication of any license under any copyrights, patents or other industrial or intellectual property rights.

Reproduction of AWINIC information in AWINIC data books or data sheets is permissible only if reproduction is without alteration and is accompanied by all associated warranties, conditions, limitations, and notices. AWINIC is not responsible or liable for such altered documentation. Information of third parties may be subject to additional restrictions.

Resale of AWINIC components or services with statements different from or beyond the parameters stated by AWINIC for that component or service voids all express and any implied warranties for the associated AWINIC component or service and is an unfair and deceptive business practice. AWINIC is not responsible or liable for any such statements.