

FEATURES

- 3.3 % EVM @ $P_{OUT} = +19$ dBm with IEEE 802.11a 64 QAM OFDM at 54 Mbps
- 2.9 % EVM @ $P_{OUT} = +20$ dBm with IEEE 802.11g 64 QAM OFDM at 54 Mbps
- -36 dBr ACPR 1st Sidelobe, +21 dBm, with 802.11b CCK/DSSS Root Cosine Filtering, 1 Mbps
- -54 dBr ACPR 2nd Sidelobe, +21 dBm, with 802.11b CCK/DSSS Root Cosine Filtering, 1 Mbps
- 32 dB of Linear Power Gain at 2.4 GHz
- 29 dB of Linear Power Gain at 5 GHz
- Single +3.3 V Supply
- Operational Voltage Range Extended to +4.4 V Max
- Dual Temperature-Compensated Linear Power Detectors
- 50 Ω - Matched RF Ports
- 1 kV ESD Rating (HBM)
- 4 mm x 4 mm x 1.3 mm Surface Mount Module

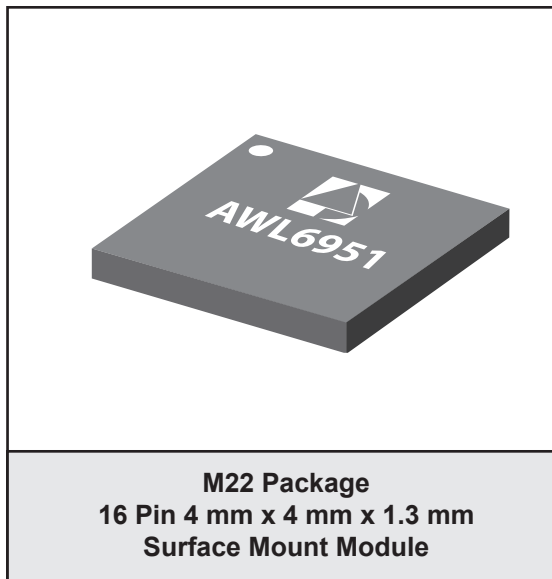

APPLICATIONS

- 802.11a/b/g/n WLAN: Notebooks, VoIP Handsets, PDA Mobile Phones

PRODUCT DESCRIPTION

The ANADIGICS AWL6951 dual band power amplifier is a high performance InGaP HBT power amplifier module designed for transmit applications in the 2.4-2.5 GHz and 4.9-5.9 GHz band. Matched to 50 Ω at all RF inputs and outputs, the part requires no additional RF matching components off-chip, making the AWL6951 the world's simplest dual band PA module implementation available. The PA exhibits unparalleled linearity and efficiency for IEEE 802.11g, 802.11b and 802.11a WLAN systems under the toughest signal configurations within these standards.

The power detectors are temperature compensated on chip, enabling separate single-ended output voltages for each band with excellent accuracy over a wide range of operating temperatures. The PA is biased by a single +3.3 V supply and consumes ultra-low current in the OFF mode.

The AWL6951 is manufactured using advanced InGaP HBT technology that offers state-of-the-art reliability, temperature stability and ruggedness.

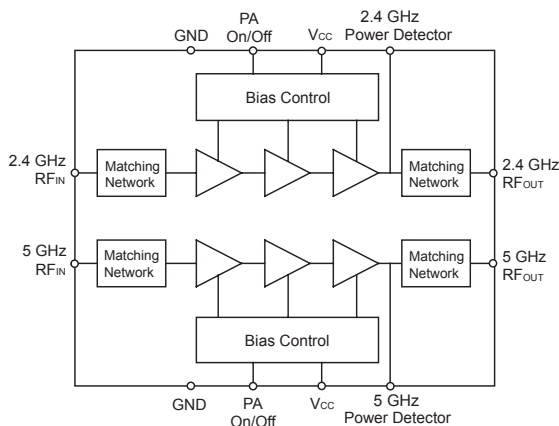

Figure 1: Block Diagram and Pinout

Table 1: Pin Description

PIN	NAME	DESCRIPTION
1	GND	Ground
2	RF _{IN} 2G	2 GHz RF Input. ESD structures on this pin provide a DC path to ground. Avoid applying DC voltage to this pin. RF is internally matched to 50 Ω and AC coupled to the input stage. Route RF traces as coplanar waveguide using adjacent ground pins.
3	RF _{IN} 5G	5 GHz RF Input. AC coupled input stage internally matched to 50 Ω . Route as coplanar waveguide using adjacent ground pins. Although the input stage is AC coupled, a shunt inductive matching element included inside the PA provides a DC path to ground at this pin.
4	GND	Ground
5	PA _{ON} 5G	5 GHz Power Control. Power amplifier power control pin. The recommended use is for on/off control of the PA. Nominally, 0 V applied will turn amplifier completely off; a voltage of 2.0 V and above will set the PA to maximum output capability. Current draw on this pin is approximately 0.5 mA at +3.3 V.
6	GND	Ground
7	V _{CC} 5G	5 GHz Supply Voltage. Bias for power transistors of the 5 GHz PA.
8	DET _{OUT} 5G	5 GHz Power Detector Output. DC coupled power detector output. An emitter follower BJT supplies the output for this pin. Output impedance is 2 k Ω .
9	RF _{OUT} 5G	5 GHz RF Output. AC coupled output stage internally matched to 50 Ω . Route as coplanar waveguide using adjacent ground pins. Although the output stage is AC coupled, a shunt inductive matching element included inside the PA provides a DC path to ground at this pin.
10	GND	Ground
11	GND	Ground
12	RF _{OUT} 2G	2 GHz RF Output. ESD structures on this pin provide a DC path to ground. Avoid applying DC voltage to this pin. RF is internally matched to 50 Ω and AC coupled to the output stage. Route RF traces as coplanar waveguide using adjacent ground pins.
13	DET _{OUT} 2G	2 GHz Power Detector Output. DC coupled power detector output. An emitter follower BJT supplies the output for this pin. Output impedance is 2 k Ω .
14	V _{CC} 2G	2 GHz Power Supply. Bias for power transistors of the 2 GHz PA.
15	GND	Ground
16	PA _{ON} 2G	2 GHz Power Control. Power amplifier power control pin. The recommended use is for on/off control of the PA. Nominally, 0 V applied will turn amplifier completely off; a voltage of 2.0 V and above will set the PA to maximum output capability. Current draw on this pin is approximately 0.5 mA at +3.3 V.

ELECTRICAL CHARACTERISTICS

Table 2: Absolute Minimum and Maximum Ratings

PARAMETER	MIN	MAX	UNIT	COMMENTS
DC Power Supply (V_{CC} 2G, V_{CC} 5G)	-	+5.0	V	
Power Control Voltage (PA_{ON} 2G, PA_{ON} 5G)	-	+5.0	V	No RF signal applied
DC Current Consumption	-	700	mA	Either PA powered separately
RF Input Level (RF_{IN} 2G, RF_{IN} 5G)	-	-5	dBm	
Operating Case Temperature	-40	+85	°C	
Storage Temperature	-55	+150	°C	
ESD Tolerance	1000	-	V	All pins, forward and reverse voltage. Human body model.

Stresses in excess of the absolute ratings may cause permanent damage. Functional operation is not implied under these conditions. Exposure to absolute ratings for extended periods of time may adversely affect reliability.

Table 3: Operating Ranges

PARAMETER	MIN	TYP	MAX	UNIT	COMMENTS
Operating Frequency (f)	2400 4900	- -	2500 5900	MHz	802.11b/g 802.11a
DC Power Supply Voltage (V_{CC} 2G, V_{CC} 5G)	+3.0	+3.3	+4.4	V	with RF applied
Power Control Voltage (PA_{ON} 2G, PA_{ON} 5G)	+2.0 0	+3.3 -	+4.4 +0.8	V	PA "ON" PA "SHUTDOWN"
Case Temperature (T_c)	-40	-	+85	°C	

The device may be operated safely over these conditions; however, parametric performance is guaranteed only over the conditions defined in the electrical specifications.

Table 4: Electrical Specifications - 2.4 GHz Continuous Wave
 (T_c = +25 °C, V_{CC} 2G = +3.3 V, PA_{ON} 2G = +3.3 V)

PARAMETER	MIN	TYP	MAX	UNIT	COMMENTS
P1dB	24.5	27	-	dBm	
Shutdown Current	-	33	100	μA	PA _{ON} 2G = 0 V
Quiescent Current	-	64	80	mA	PA _{ON} 2G = +2.0 V, V _{CC} 2G = +3.3 V RF = off
Harmonics 2fo 3fo	- - -	-36 -23	-27 -17	dBm	P _{OUT} 2G = +23 dBm, fo = 2.45 GHz, RBW = 1 MHz
Input Return Loss	-	-14	-10	dB	
Output Return Loss	-	-7	-4	dB	
Reverse Isolation	40	-	-	dB	
Stability (Spurious)	-	-	-60	dBc	6:1 VSWR, at P _{OUT} = +23 dBm, -5 °C
T _{ON} Setting Time	-	-	1	μS	Settles within ±0.5 dB
T _{OFF} Setting Time	-	-	1	μS	
PA _{ON} 2G Pin Input Impedance	-	6.2	-	kΩ	Measured with +3.3 V applied to PA _{ON} 2G pin

Table 5: Electrical Specifications - 5 GHz Continuous Wave
(T_C = +25 °C, V_{CC} 5G = +3.3 V, PA_{ON} 5G = +3.3 V)

PARAMETER	MIN	TYP	MAX	UNIT	COMMENTS
P1dB	24	26.5	-	dBm	
Shutdown Current	-	33	100	μA	PA _{ON} 5G = 0 V
Quiescent Current	-	86	107	mA	PA _{ON} 5G = +2.0 V, V _{CC} 5G = +3.3 V RF = off
Harmonics 2f _o 3f _o	- - -	-26 -42	-17 -33	dBm	P _{OUT} 5G = +20 dBm, f _o = 5.5 GHz, RBW = 1 MHz
Input Return Loss	-	-17	-10	dB	
Output Return Loss	-	-14	-10	dB	
Reverse Isolation	40	-	-	dB	
Stability (Spurious)	-	-	-60	dBc	6:1 VSWR, at P _{OUT} = +22 dBm; -5 °C
T _{ON} Setting Time	-	-	1	μS	Settles within ±0.5 dB
T _{OFF} Setting Time	-	-	1	μS	
PA _{ON} 5G Pin Input Impedance	-	6.2	-	kΩ	Measured with +3.3 V applied to PA _{ON} 5G pin

Table 6: Electrical Specifications - IEEE 802.11g
 (T_c = +25 °C, V_{CC 2G} = +3.3 V, P_{AON 2G} = +3.3 V, 64 QAM OFDM 54 Mbps)

PARAMETER	MIN	TYP	MAX	UNIT	COMMENTS
Operating Frequency	2400	-	2500	MHz	
Power Gain	29	32	35	dB	
Gain Ripple	-	±0.2	±0.5	dB	Across any 100 MHz band
Error Vector Magnitude (EVM) ⁽¹⁾	-	2.9	4.5	%	802.11g 54 Mbps data rate P _{OUT 2G} = +20 dBm
	-	-30.8	-27.0	dB	
Current Consumption	-	175	205	mA	P _{OUT 2G} = +20 dBm
Power Detector Voltage	960	1100	1240	mV	P _{OUT 2G} = +20 dBm, Freq = 2.45 GHz
Power Detector Output Load Impedance	2	-	-	kΩ	

Note:

(1) EVM includes system noise floor of 1% (-40 dB).

Table 7: Electrical Specifications - IEEE 802.11b
 (T_c = +25 °C, V_{CC 2G} = +3.3 V, P_{AON 2G} = +3.3 V, CCK/DSSS,
 1 Mbps, Root Cosine Baseband Filtering, α = 0.50)

PARAMETER	MIN	TYP	MAX	UNIT	COMMENTS
Operating Frequency	2400	-	2500	MHz	
Power Gain	29	32	35	dB	
Gain Ripple	-	±0.2	±0.5	dB	Across any 100 MHz band
Adjacent Channel Power (ACPR) 1st Sidelobe (± 11 MHz Offset)	-	-36	-32	dBc	1 Mbps Root Cosine Baseband Filtering; P _{OUT 2G} = +21 dBm
Adjacent Channel Power (ACPR) 2nd Sidelobe (± 22 MHz Offset)	-	-54	-50	dBc	1 Mbps Root Cosine Baseband Filtering; P _{OUT 2G} = +21 dBm
Current Consumption	-	200	235	mA	P _{OUT 2G} = +21 dBm
Power Detector Voltage	1150	1275	1400	mV	P _{OUT 2G} = +21 dBm, Freq = 2.45 GHz
Power Detector Output Load Impedance	2	-	-	kΩ	

Table 8: Electrical Specifications - IEEE 802.11a
(T_c = +25 °C, V_{cc} 5G = +3.3 V, P_{AON} 5G = +3.3 V, 64 QAM OFDM 54 Mbps)

PARAMETER	MIN	TYP	MAX	UNIT	COMMENTS
Operating Frequency	4900	-	5900	MHz	
Power Gain	26	29	33	dB	4.9 - 5.85 GHz
Gain Ripple	-	± 0.5	± 2.0	dB	Across any 100 MHz band
Error Vector Magnitude (EVM) ⁽¹⁾	-	3.3	4.5	%	P _{OUT} 5G = +19 dBm, 4.9 - 5.85 GHz 802.11a 54 Mbps data rate
	-	-29.6	-27.0	dB	
Current Consumption	-	175	210	mA	P _{OUT} 5G = +19 dBm
Power Detector Voltage	1200	1350	1500	mV	P _{OUT} 5G = +19 dBm, Freq = 5.55 GHz
Power Detector Output Load Impedance	2	-	-	kΩ	

Notes:

(1) EVM includes system noise floor of 1% (-40dB).

802.11g PERFORMANCE DATA at $V_{CC} = +3.3\text{ V}$

Figure 2: Gain and I_{CC} vs. Output Power Across Frequency ($V_{CC} = +3.3\text{ V}$, $T_c = +25^\circ\text{C}$)
802.11g 54 Mbps OFDM

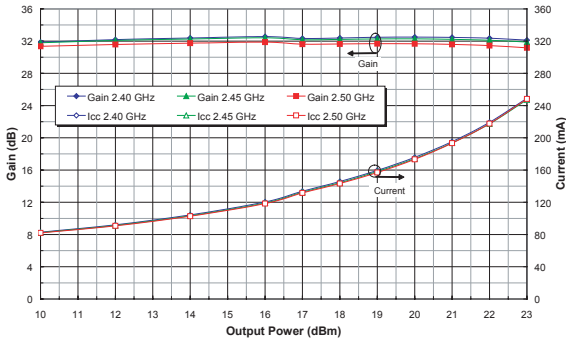

Figure 3: EVM vs. Output Power Across Frequency ($V_{CC} = +3.3\text{ V}$, $T_c = 25^\circ\text{C}$)
802.11g 54 Mbps OFDM

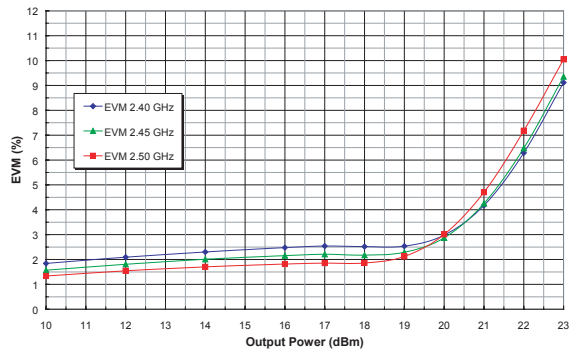

Figure 4: Gain and I_{CC} vs. Output Power Across Temp (Frequency = 2.45 GHz, $V_{CC} = +3.3\text{ V}$)
802.11g 54 Mbps OFDM

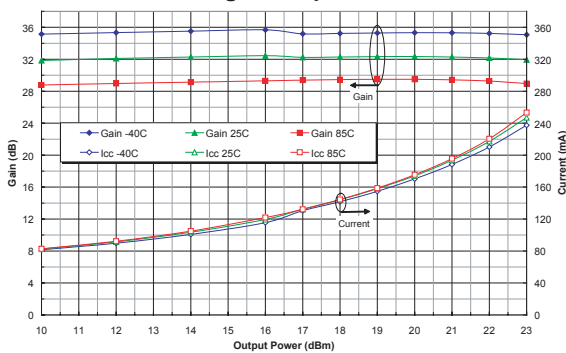

Figure 5: EVM vs. Output Power Across Temp (Frequency = 2.45 GHz, $V_{CC} = +3.3\text{ V}$)
802.11g 54 Mbps OFDM

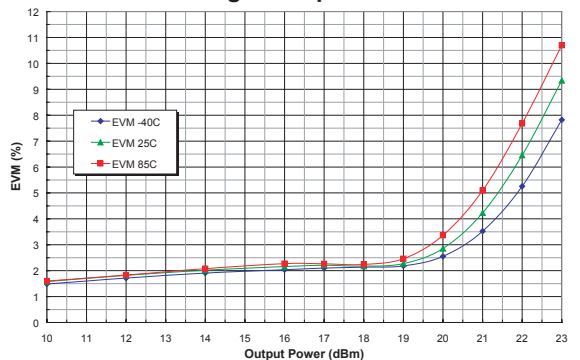

Figure 6: Gain and I_{CC} vs. Output Power Across Supply Voltage (Freq = 2.45 GHz, $T_c = 25^\circ\text{C}$)
802.11g 54 Mbps OFDM

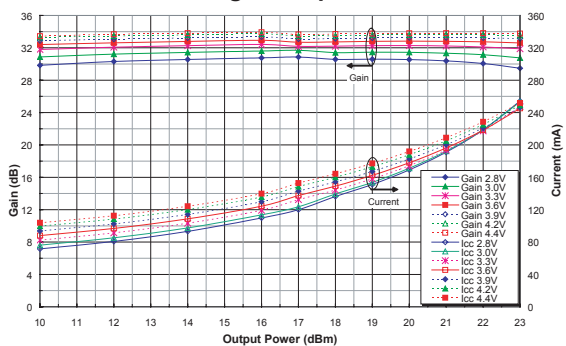
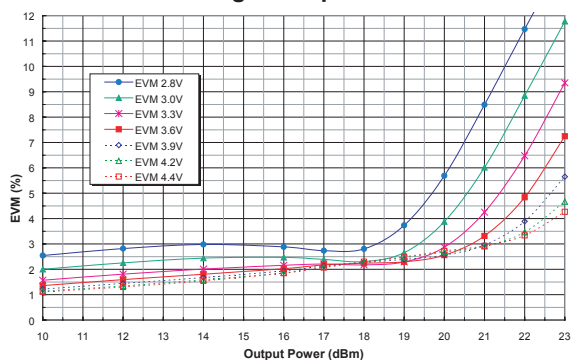

Figure 7: EVM vs. Output Power Across Supply Voltage (Freq = 2.45 GHz, $T_c = 25^\circ\text{C}$)
802.11g 54 Mbps OFDM



**Figure 8: Detector Voltage vs. Output Power Across Frequency ($T_c = 25^\circ\text{C}$, $V_{CC} = +3.3\text{ V}$)
802.11g 54 Mbps OFDM**

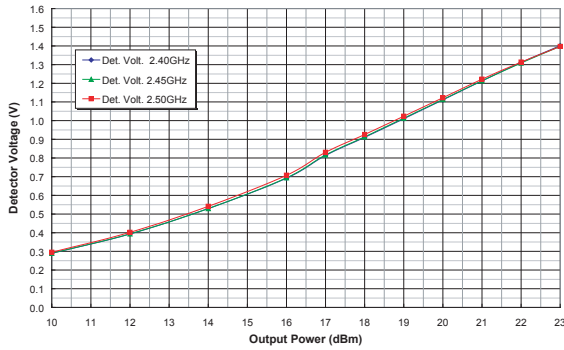
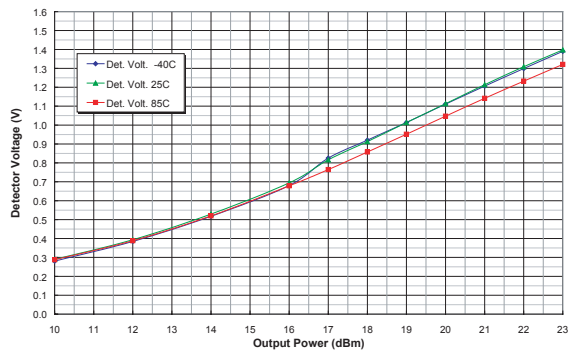

Figure 9: Detector Voltage vs. Output Power Across Temperature (Frequency = 2.45 GHz, $V_{CC} = +3.3\text{ V}$) 802.11g 54 Mbps OFDM



802.11b PERFORMANCE DATA at V_{CC} = +3.3 V

Figure 10: Gain and I_{CC} vs. Output Power Across Frequency (V_{CC} = +3.3 V, T_c = 25°C)
802.11b Root Cosine Filtering (α = 0.50), 1Mbps

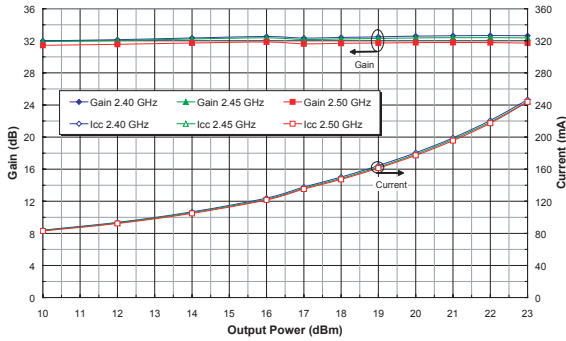

Figure 11: ACPR 1st and 2nd Sidelobe vs. Output Power Across Frequency (V_{CC} = +3.3 V, T_c = 25°C)
802.11b Root Cosine Filtering (α = 0.50), 1Mbps

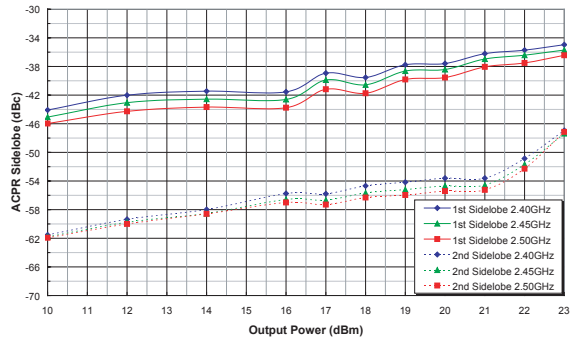

Figure 12: Gain and I_{CC} vs. Output Power Across Temp (Freq = 2.45 GHz, V_{CC} = +3.3 V)
802.11b Root Cosine Filtering (α = 0.50), 1Mbps

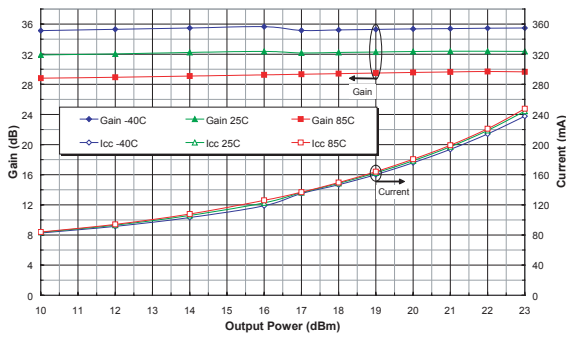

Figure 13: ACPR 1st and 2nd Sidelobe vs. Output Power Across Temp (Freq = 2.45 GHz, V_{CC} = +3.3 V)
802.11b Root Cosine Filtering (α = 0.50), 1Mbps

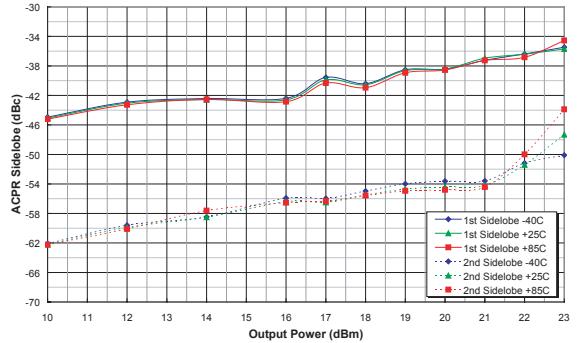

Figure 14: Gain and I_{CC} vs. Output Power Across Power Supply Voltage (Freq = 2.45 GHz, T_c = 25°C)
802.11b Root Cosine Filtering (α = 0.50), 1Mbps

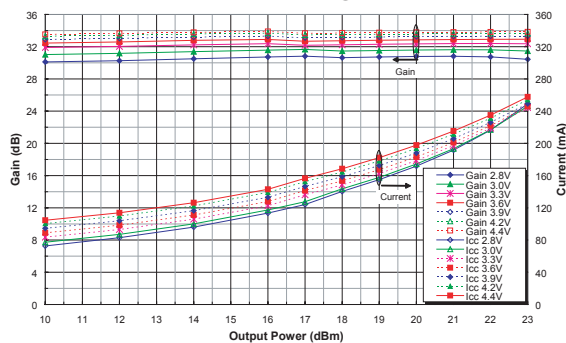

Figure 15: ACPR Sidelobe 1 vs. Output Power Across Power Supply Voltage (Freq = 2.45 GHz, T_c = 25°C)
802.11b Root Cosine Filtering (α = 0.50), 1Mbps

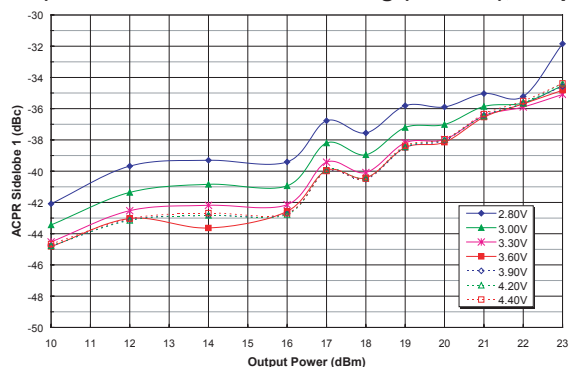

Figure 16: ACPR Sidelobe 2 vs. Output Power Across Power Supply Voltage (Freq = 2.45 GHz, T_c = 25°C) 802.11b Root Cosine Filtering ($\alpha = 0.50$), 1Mbps

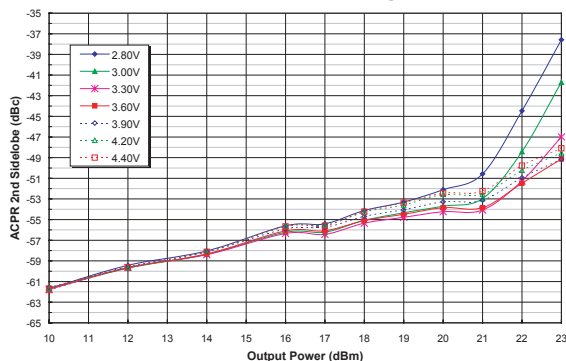

Figure 17: Detector Voltage vs. Output Power Across Frequency (T_c = 25°C, V_{CC} = +3.3 V) 802.11b Root Cosine Filtering ($\alpha = 0.50$), 1 Mbps

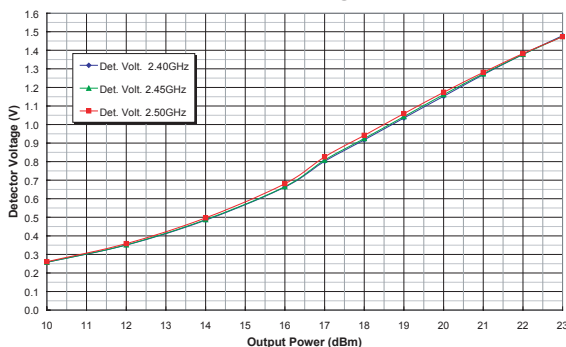
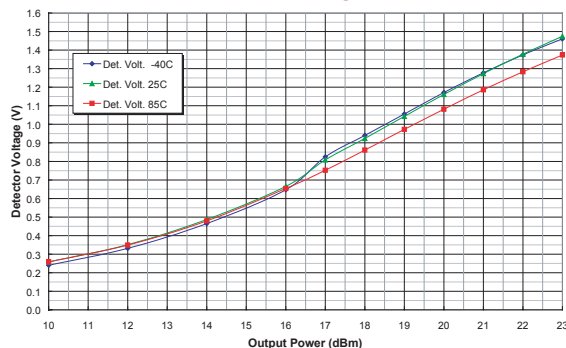

Figure 18: Detector Voltage vs. Output Power Across Temp (Frequency = 2.45 GHz, V_{CC} = +3.3V) 802.11b Root Cosine Filtering ($\alpha = 0.50$), 1 Mbps



802.11a PERFORMANCE DATA at $V_{CC} = +3.3\text{ V}$

Figure 19: Gain and I_{CC} vs. Output Power Across Freq ($V_{CC} = +3.3\text{ V}$, $T_c = 25^\circ\text{C}$)
802.11a 54 Mbps OFDM

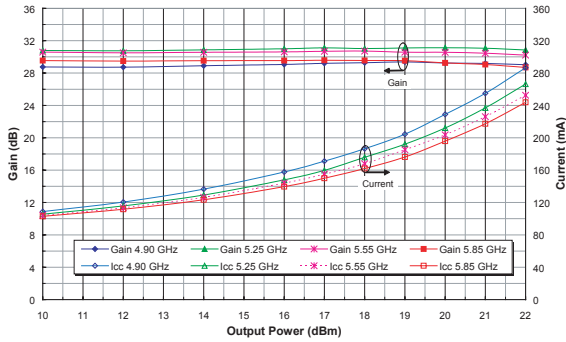

Figure 20: EVM vs. Output Power Across Freq ($V_{CC} = +3.3\text{ V}$, $T_c = 25^\circ\text{C}$)
802.11a 54 Mbps OFDM

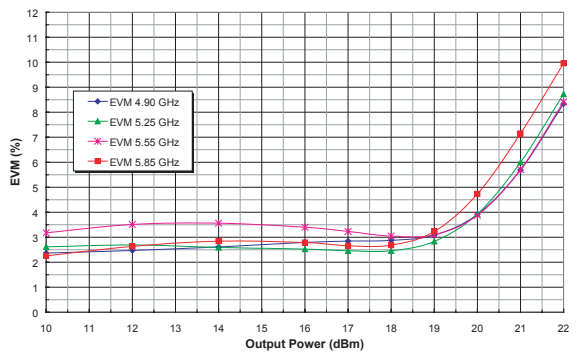

Figure 21: Gain and I_{CC} vs. Output Power Across Temp (Freq = 5.25 GHz, $V_{CC} = +3.3\text{ V}$)
802.11a 54 Mbps OFDM

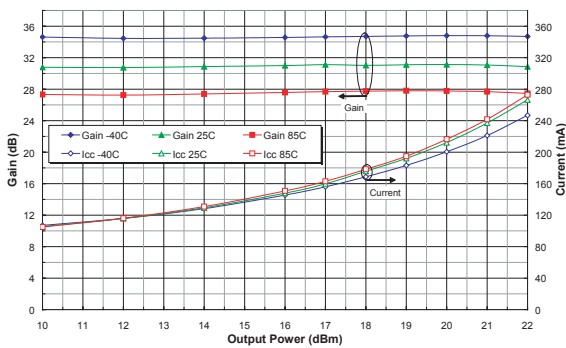

Figure 22: EVM vs. Output Power Across Temp (Freq = 5.25 GHz, $V_{CC} = +3.3\text{ V}$)
802.11a 54 Mbps OFDM

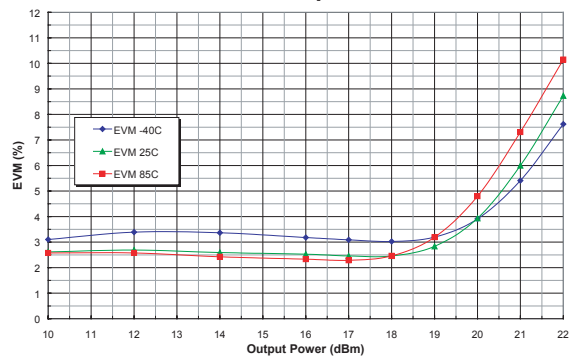

Figure 23: Gain and I_{CC} vs. Output Power Across Supply Voltage (Freq = 5.25 GHz, $T_c = 25^\circ\text{C}$)
802.11a 54 Mbps OFDM

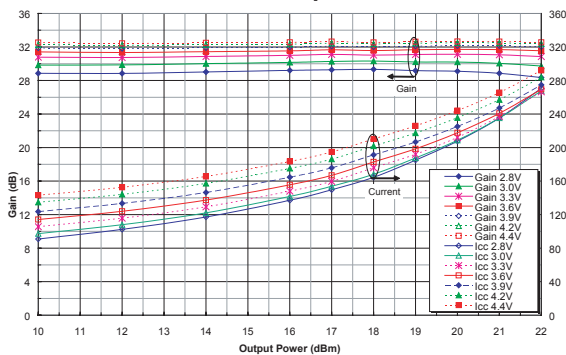
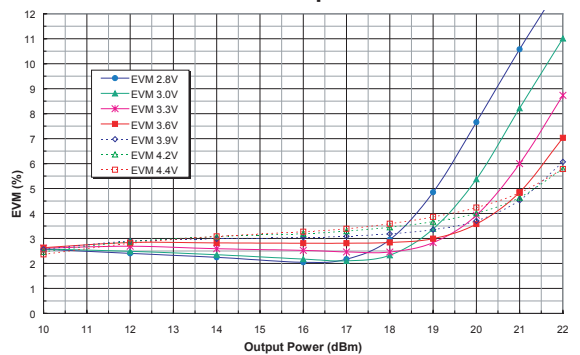
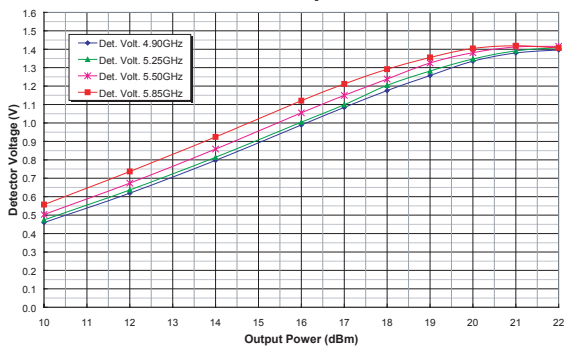

Figure 24: EVM vs. Output Power Across Supply Voltage (Freq = 5.25 GHz, $T_c = 25^\circ\text{C}$)
802.11a 54 Mbps OFDM



**Figure 25: Detector Voltage vs. Output Power Across Frequency (T_c = 25°C, V_{cc} = +3.3 V)
802.11a 54 Mbps OFDM**



**Figure 26: Detector Voltage vs. Output Power Across Temp (Frequency = 5.25 GHz, V_{cc} = +3.3V)
802.11a 54 Mbps OFDM**

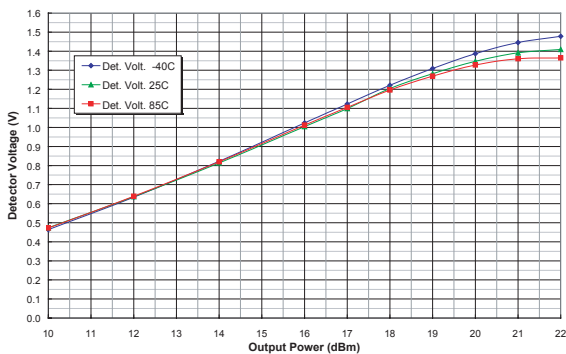

802.11g PERFORMANCE DATA at V_{CC} = +4.2 V

Figure 27: Gain and I_{CC} vs. Output Power Across Frequency (V_{CC} = +4.2 V, T_C = +25°C)
802.11g 54 Mbps OFDM

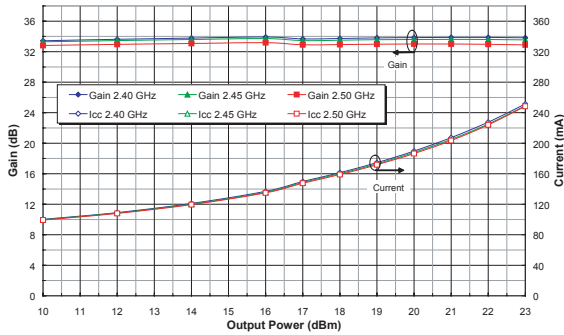

Figure 28: EVM vs. Output Power Across Frequency (V_{CC} = +4.2 V, T_C = 25°C)
802.11g 54 Mbps OFDM

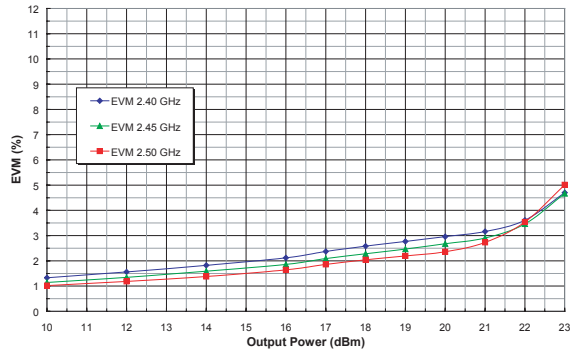

Figure 29: Gain and I_{CC} vs. Output Power Across Temp (Frequency = 2.45 GHz, V_{CC} = +4.2 V)
802.11g 54 Mbps OFDM

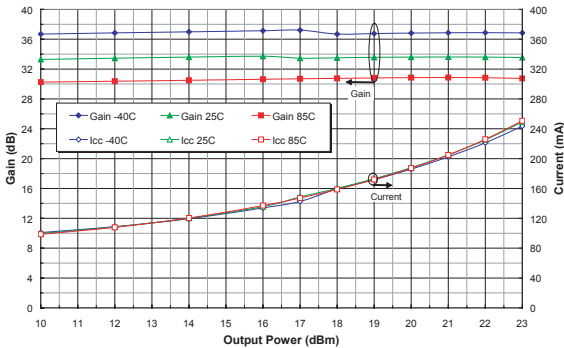

Figure 30: EVM vs. Output Power Across Temp (Frequency = 2.45 GHz, V_{CC} = +4.2 V)
802.11g 54 Mbps OFDM

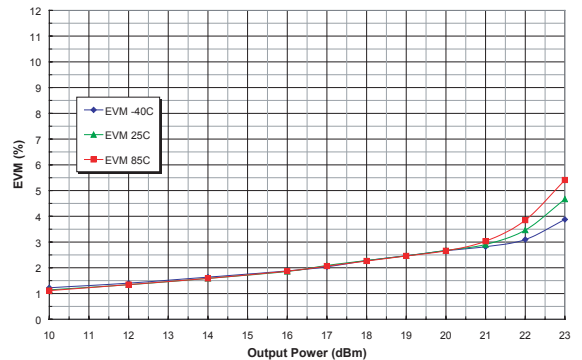

Figure 31: Detector Voltage vs. Output Power Across Frequency (T_C = 25°C, V_{CC} = +4.2 V)
802.11g 54 Mbps OFDM

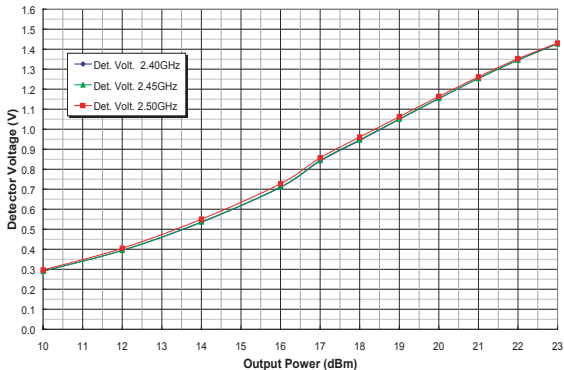
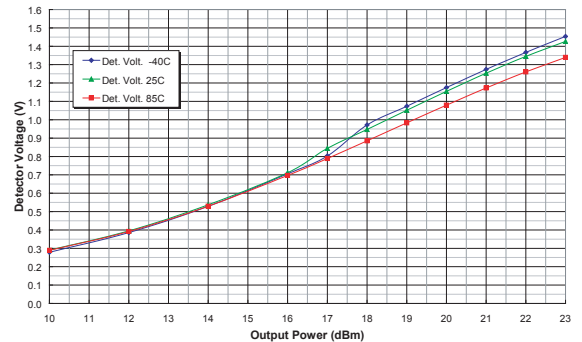

Figure 32: Detector Voltage vs. Output Power Across Temperature (Frequency = 2.45 GHz, V_{CC} = +4.2 V)
802.11g 54 Mbps OFDM



802.11b PERFORMANCE DATA at $V_{CC} = +4.2\text{ V}$

Figure 33: Gain and I_{CC} vs. Output Power Across Frequency ($V_{CC} = +4.2\text{ V}$, $T_c = 25^\circ\text{C}$)
802.11b Root Cosine Filtering ($\alpha = 0.50$), 1Mbps

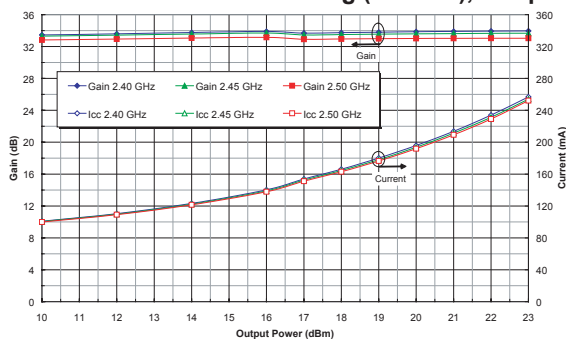

Figure 34: ACPR 1st and 2nd Sidelobe vs. Output Power Across Frequency ($V_{CC} = +4.2\text{ V}$, $T_c = 25^\circ\text{C}$)
802.11b Root Cosine Filtering ($\alpha = 0.50$), 1Mbps

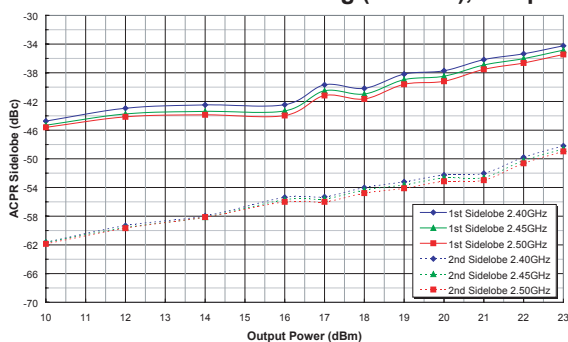

Figure 35: Gain and I_{CC} vs. Output Power Across Temp (Freq = 2.45 GHz, $V_{CC} = +4.2\text{ V}$)
802.11b Root Cosine Filtering ($\alpha = 0.50$), 1Mbps

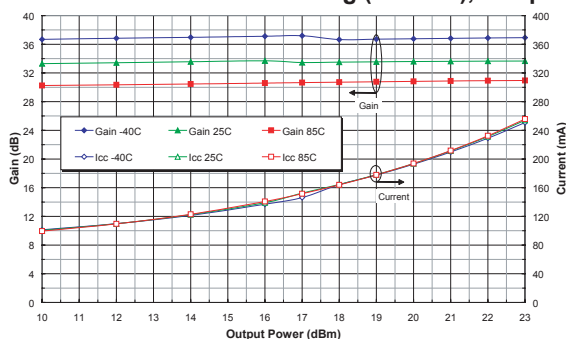

Figure 36: ACPR 1st and 2nd Sidelobe vs. Output Power Across Temp (Freq = 2.45 GHz, $V_{CC} = +4.2\text{ V}$)
802.11b Root Cosine Filtering ($\alpha = 0.50$), 1Mbps

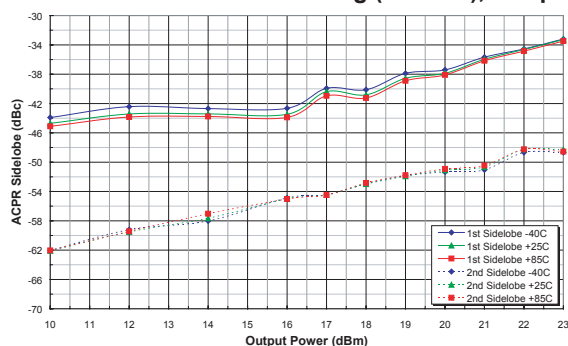

Figure 37: Detector Voltage vs. Output Power Across Frequency ($T_c = 25^\circ\text{C}$, $V_{CC} = +3.3\text{ V}$)
802.11b Root Cosine Filtering ($\alpha = 0.50$), 1 Mbps

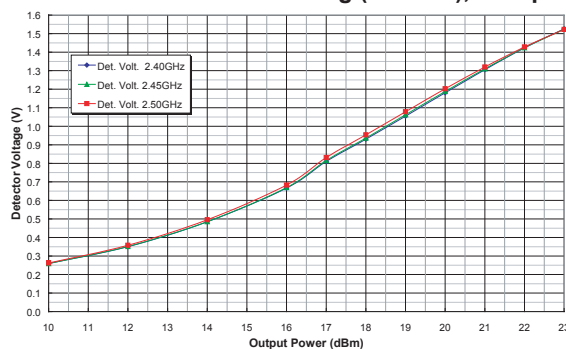
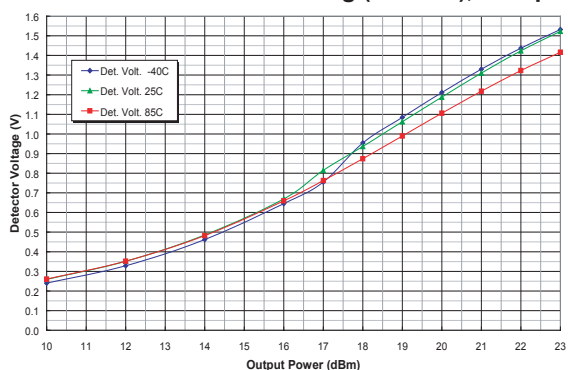

Figure 38: Detector Voltage vs. Output Power Across Temp (Frequency = 2.45 GHz, $V_{CC} = +3.3\text{ V}$)
802.11b Root Cosine Filtering ($\alpha = 0.50$), 1 Mbps



802.11a PERFORMANCE DATA at $V_{CC} = +4.2 V$

Figure 39: Gain and I_{CC} vs. Output Power Across Freq ($V_{CC} = +4.2 V, T_C = 25^\circ C$)
802.11a 54 Mbps OFDM

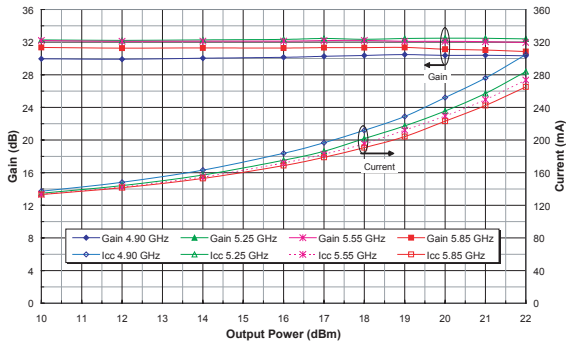

Figure 40: EVM vs. Output Power Across Freq ($V_{CC} = +4.2 V, T_C = 25^\circ C$)
802.11a 54 Mbps OFDM

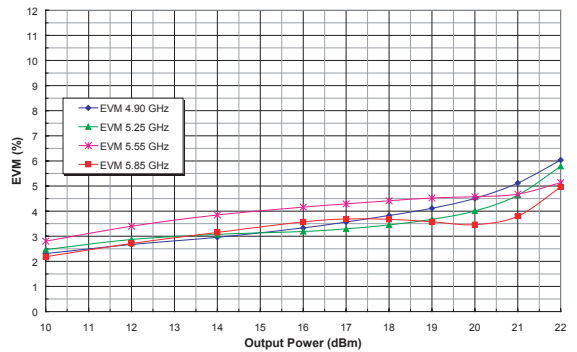

Figure 41: Gain and I_{CC} vs. Output Power Across Temp (Freq = 5.25 GHz, $V_{CC} = +4.2 V$)
802.11a 54 Mbps OFDM

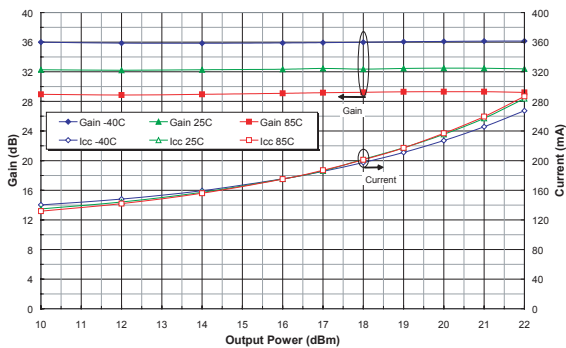

Figure 42: EVM vs. Output Power Across Temp (Freq = 5.25 GHz, $V_{CC} = +4.2 V$)
802.11a 54 Mbps OFDM

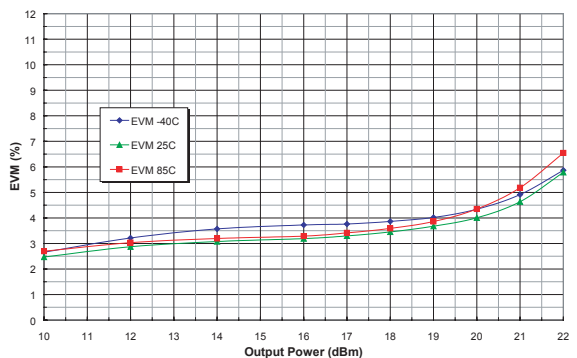

Figure 43: Detector Voltage vs. Output Power Across Frequency ($T_C = 25^\circ C, V_{CC} = +4.2 V$)
802.11a 54 Mbps OFDM

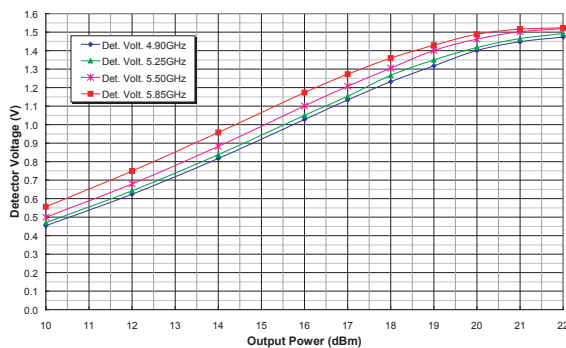
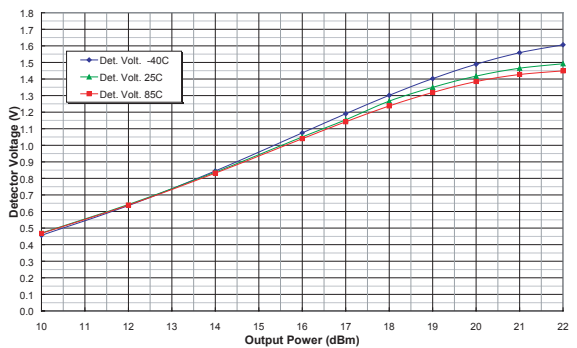

Figure 44: Detector Voltage vs. Output Power Across Temp (Frequency = 5.25 GHz, $V_{CC} = +4.2 V$)
802.11a 54 Mbps OFDM



S-PARAMETER PERFORMANCE DATA at 2.4 GHz

Figure 45: 2.4 GHz S21 Response
(T_c = 25°C, V_{cc} = +3.3 V)

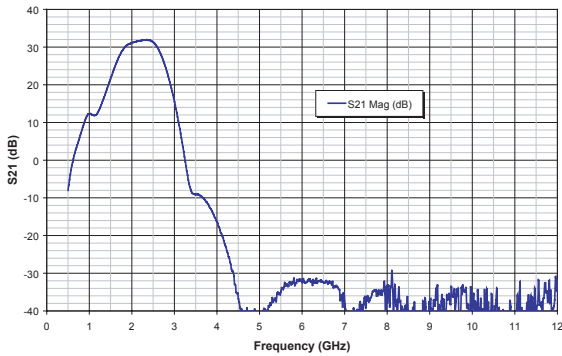

Figure 46: 2.4 GHz S11 and S22 Response
(T_c = 25°C, V_{cc} = +3.3 V)

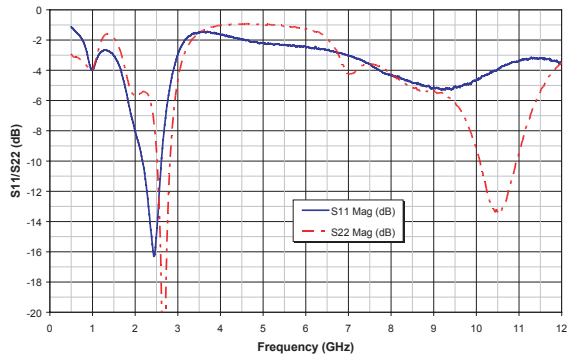

Figure 47: 2.4 GHz S21 Response
(T_c = 25°C, V_{cc} = +4.2 V)

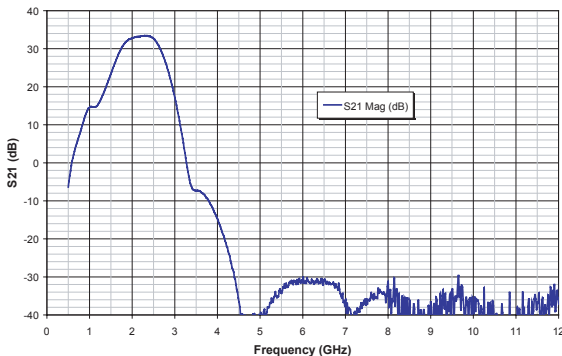
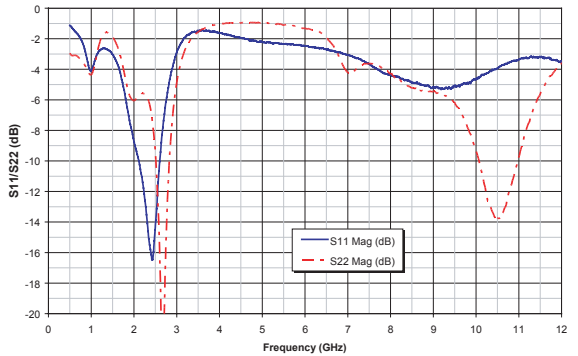

Figure 48: 2.4 GHz S11 and S22 Response
(T_c = 25°C, V_{cc} = +4.2 V)



S-PARAMETER PERFORMANCE DATA at 5 GHz

Figure 49: 5 GHz S21 Response
(T_C = 25°C, V_{CC} = +3.3 V)

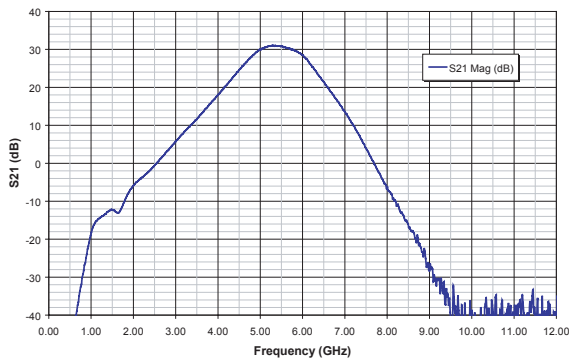

Figure 50: 5 GHz S11 and S22 Response
(T_C = 25°C, V_{CC} = +3.3 V)

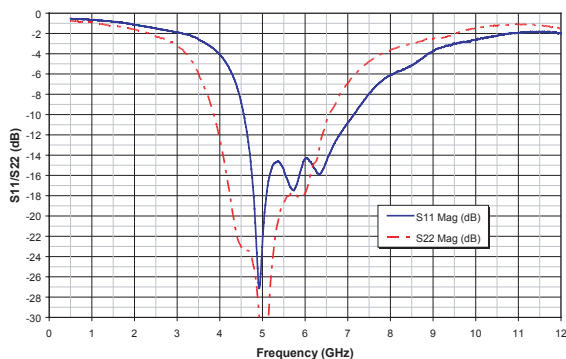

Figure 51: 5 GHz S21 Response
(T_C = 25°C, V_{CC} = +4.2 V)

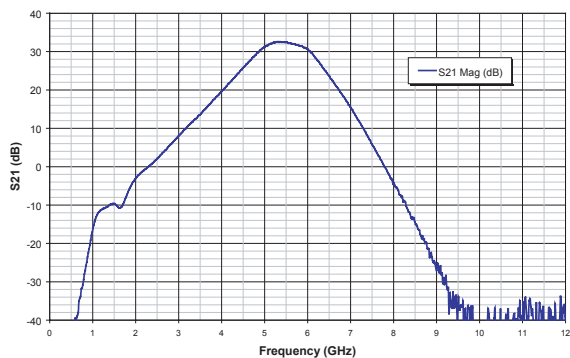
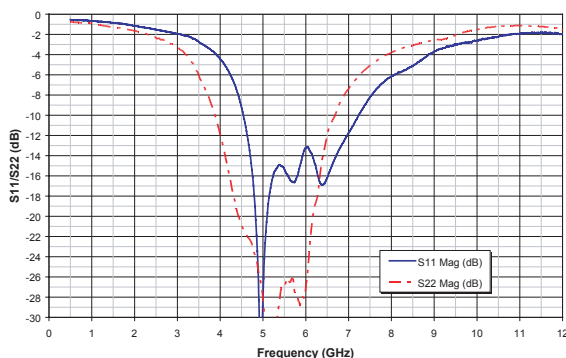

Figure 52: 5 GHz S11 and S22 Response
(T_C = 25°C, V_{CC} = +4.2 V)



APPLICATION INFORMATION

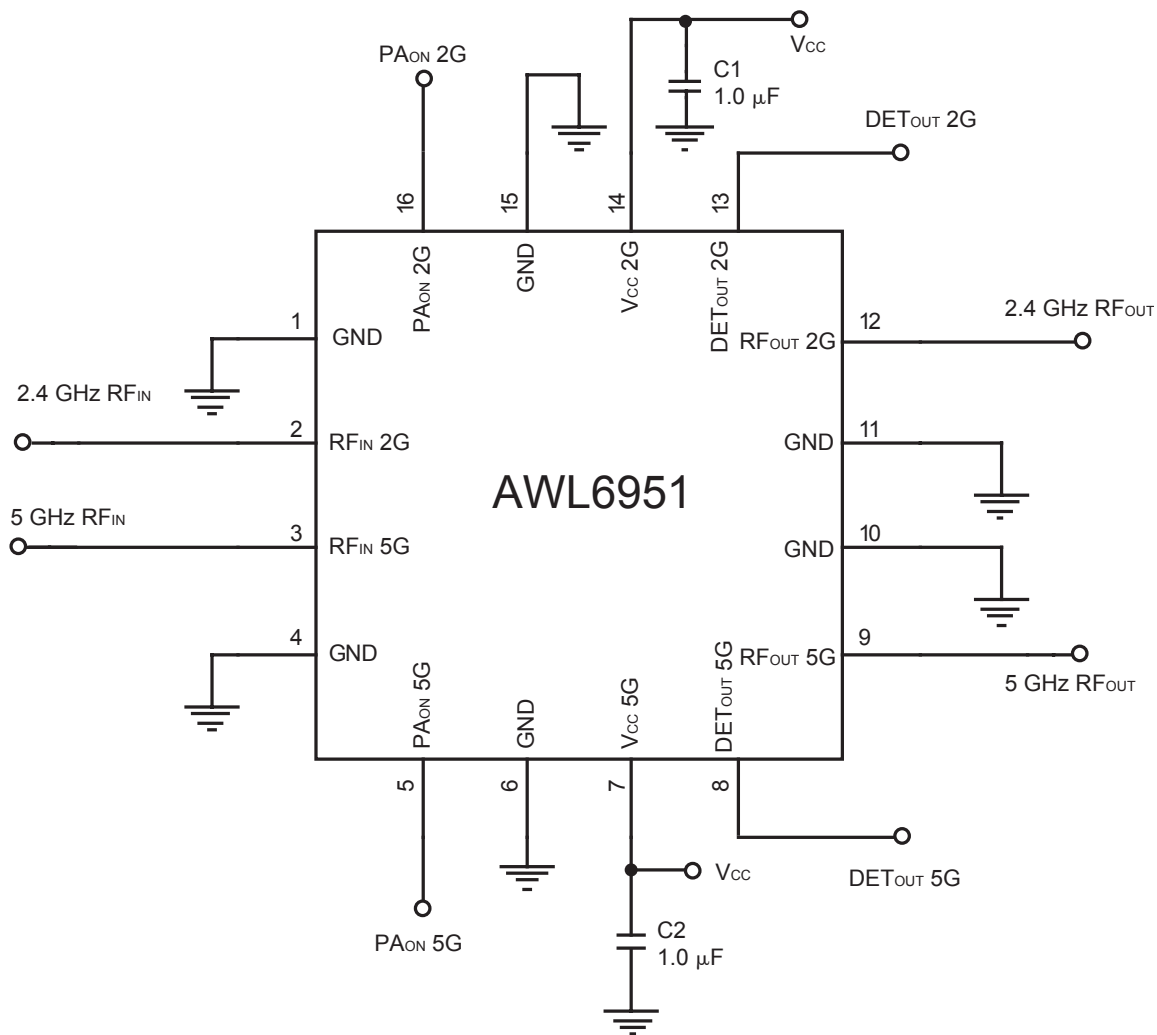
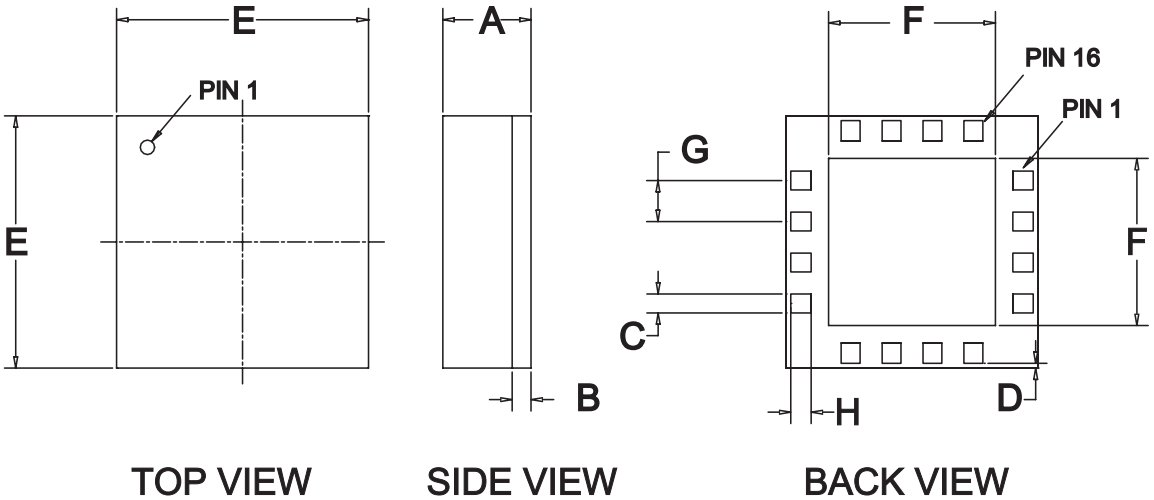

Figure 53: Application Circuit

PACKAGE OUTLINE



TOP VIEW

SIDE VIEW

BACK VIEW

DIMENSION	MILLIMETERS		
	MIN	TYP	MAX
A	1.22	1.30	1.40
B	--	0.30	--
C	0.225	--	0.505
D	--	0.075	--
E	3.88	4.00	4.12
F	2.56	--	2.73
G	--	0.65	--
H	0.225	--	0.505

Figure 54: M22 Package Outline - 16 Pin 4 mm x 4 mm x 1.3 mm Surface Mount Module

TOP BRAND



Notes:

- ANADIGICS LOGO SIZE: 1.0 mm HIGH
- PART NUMBER (LINE 1): AWL6951R
- WAFER LOT NUMBER (LINE 2): LLLL = LAST FOUR DIGITS OF LOT NUMBER
NN = TWO DIGIT WAFER NUMBER
- PIN 1 INDICATOR: LASER DOT
- ASSEMBLY INFO (LINE 3): F = REV F
YY = TWO DIGIT YEAR, WW = WORK WEEK
COUNTRY CODE
- TYPE = ARIAL
SIZE = 1.5 POINT
COLOR = LASER
CC - TH: THAILAND, TW = TAIWAN
PH: PHILLIPPINES, CH: CHINA
ID: INDONESIA, HK: HONG KONG
US: UNITED STATES

Figure 55: Branding Specification

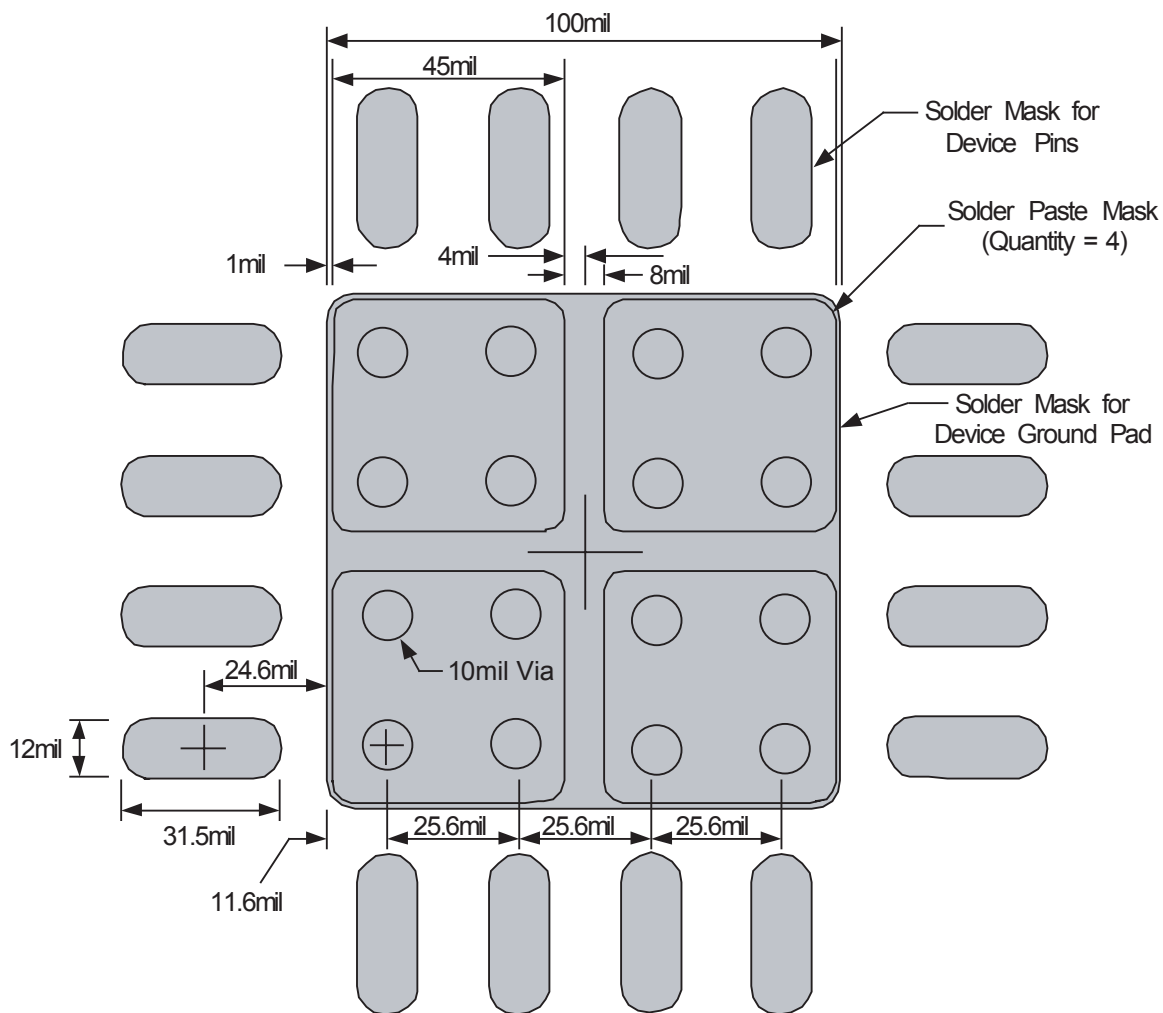

Figure 56: Recommended PCB Layout

ORDERING INFORMATION

ORDER NUMBER	TEMPERATURE RANGE	PACKAGE DESCRIPTION	COMPONENT PACKAGING
AWL6951RM22P8	-40 °C to +85°C	RoHS-compliant 16 Pin 4 mm x 4 mm x 1.3 mm Surface Mount Module	2,500 piece Tape and Reel
AWL6951RM22P0	-40 °C to +85°C	RoHS-compliant 16 Pin 4 mm x 4 mm x 1.3 mm Surface Mount Module	1-999 piece Tubes
AWL6951RM22P6	-40 °C to +85°C	RoHS-compliant 16 Pin 4 mm x 4 mm x 1.3 mm Surface Mount Module	1-999 piece Tray
EVA6951RM22	-40 °C to +85°C	RoHS-compliant 16 Pin 4 mm x 4 mm x 1.3 mm Surface Mount Module	1 piece Evaluation Board

**ANADIGICS, Inc.**

141 Mount Bethel Road
Warren, New Jersey 07059, U.S.A.

Tel: +1 (908) 668-5000

Fax: +1 (908) 668-5132

URL: <http://www.anadigics.com>

E-mail: Mktg@anadigics.com

IMPORTANT NOTICE

ANADIGICS, Inc. reserves the right to make changes to its products or to discontinue any product at any time without notice. The product specifications contained in Advanced Product Information sheets and Preliminary Data Sheets are subject to change prior to a product's formal introduction. Information in Data Sheets have been carefully checked and are assumed to be reliable; however, ANADIGICS assumes no responsibilities for inaccuracies. ANADIGICS strongly urges customers to verify that the information they are using is current before placing orders.

WARNING

ANADIGICS products are not intended for use in life support appliances, devices or systems. Use of an ANADIGICS product in any such application without written consent is prohibited.