



## AWT6105

Cellular Dual Mode AMPS/CDMA  
3.5V/28.5dBm Linear Power Amplifier Module  
PRELIMINARY DATASHEET - Rev 1.2

### FEATURES

- InGaP HBT Technology
- High Efficiency 45% AMPS
- High Efficiency 35% CDMA
- Low Leakage Current ( $<5\mu\text{A}$ )
- SMT Module Package
- Small Foot Print (6mm x 6mm)
- Low Profile (1.5mm)
- $50\ \Omega$  Input and Output Matching
- Low Quiescent Current ( $I_{\text{cq}} = 50\text{mA Typ}$ )
- Shut Down and Mode Control
- CDMA 2000 1XRTT Compliant

### APPLICATIONS

- Dual Mode AMPS/CDMA Wireless Handsets

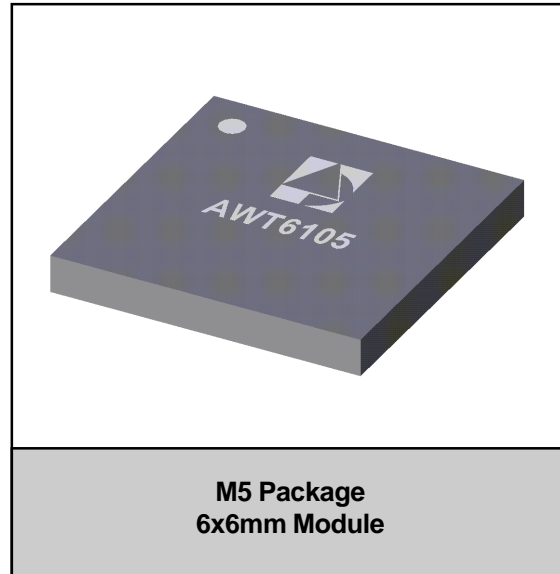

### PRODUCT DESCRIPTION

The AWT6105 is a high power, high efficiency amplifier module for Dual Mode CDMA/AMPS wireless handset applications. The device is manufactured on an advanced InGaP HBT MMIC technology offering state-of-the-art reliability, temperature stability and ruggedness. A low power

quiescent current mode is digitally controlled to reduce power drain on the system battery. The 6mm x 6mm laminate package is self contained, incorporating  $50\ \Omega$  input and output matching networks optimized for output power, linearity, and efficiency.

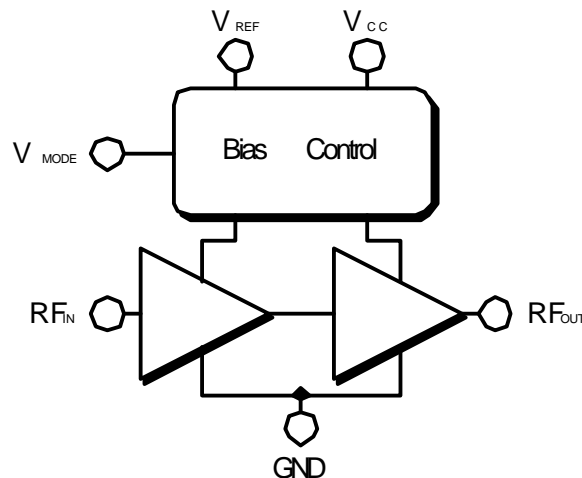

Figure 1: Block Diagram

10/2001

AWT6105

Table 1: Pin Description

PIN	NAME	DESCRIPTION
1	$V_{CC}$	Supply Voltage
2	$RF_{IN}$	RF Input Signal
3	$V_{REF}$	Reference Voltage
4	$V_{MODE}$	Mode Control
5	$V_{CC}$	Supply Voltage
6	$RF_{OUT}$	RF output
7	GND	Ground

## ELECTRICAL CHARACTERISTICS

Table 2: Absolute Minimum and Maximum Ratings

PARAMETER	MIN	MAX	UNIT
Supply Voltage ( $V_{CC}$ )		+5	V
$V_{MOD}$ Voltage ( $V_{MOD}$ )		+3.5	V
Control Voltage ( $V_{REF}$ )		+3.5	V
Input Power ( $RF_{IN}$ )		+10	dBm
Operating Temperature ( $T_C$ )	-30	110	°C
Storage Temperature ( $T_{STG}$ )	-40	150	°C

Stresses in excess of the absolute ratings may cause permanent damage. Functional operation is not implied under these conditions. Exposure to absolute ratings for extended periods of time may adversely affect reliability.

Note: Module may withstand all conditions.

## AWT6105

Table 3: Electrical Specifications (AMPS 824-849 MHz)

PARAMETER	MIN	TYP	MAX	UNIT
Frequency Range	824		849	MHz
Supply Voltage Range	3.0	3.5	4.2	V
Ref Voltage Range: PA "on"	2.9	3.0	3.1	V
Ref Voltage Range: PA "off"		0	0.5	V
Ref current		5	7	mA
V <sub>MODE</sub> High Bias		0	0.5	V
V <sub>MODE</sub> Low Bias	2.5	3	3.1	V
Gain, P <sub>OUT</sub> = 31 dBm		28	31	dB
Output Power, V <sub>CC</sub> = 3.5V	31	32		dBm
Output Power, V <sub>CC</sub> = 3.0V	30			dBm
Input Impedance			2:1	Ratio
Power Added Efficiency P <sub>OUT</sub> = 31dBm V <sub>CC</sub> =3.5V, V <sub>MODE</sub> = 2.7V		46		%
I <sub>cq</sub> (V <sub>MODE</sub> = 2.7V) Low Power Mode		50		mA
Noise at Receiver Band P <sub>OUT</sub> ≤ 31 dBm		-135		dBm/Hz
Leakage Current V <sub>CC</sub> = 3.5V ; V <sub>REF</sub> = 0V ; V <sub>MODE</sub> = 0V		5		μA
Harmonics 2fo, P <sub>OUT</sub> = 31 dBm		-40	-30	dBc
3fo, P <sub>OUT</sub> = 31 dBm		-50	-30	dBc
Stability (out of band load VSWR ≤ 8:1) (in band load VSWR ≤ 8:1) Over Temperature and & Voltage			-70	dBc, all spurious P <sub>OUT</sub> ≤ 31dBm
Ruggedness Stress for no permanent degradation or failure, VCC = 5.0 Over Temperature	8:1			Ratio

Note: Unless otherwise specified: V<sub>cc</sub> = 3.5V, Z<sub>N</sub> = Z<sub>OUT</sub> = 50Ω System, T<sub>C</sub> = 25 °C

Table 4: Bias Control

Bias Mode	V <sub>MODE</sub>	ICQ TYP	POWER RANGE	P <sub>OUT</sub> LEVELS	MODE
Low	2.7V	50 mA	All	0-32 dBm	AMPS All Power Levels
Low	2.7V	50 mA	Low	-50 to +20 dBm	CDMA Low Power
High	0V	100 mA	High	20-29 dBm	CDMA High Power

## AWT6105

Table 5: Electrical Specifications (CDMA 824-849 MHz)

PARAMETER	MIN	TYP	MAX	UNIT
Frequency Range	824		849	MHz
Supply Voltage Range	3.0	3.5	4.2	V
Ref Voltage Range:PA "on"	2.9	3.0	3.1	V
Ref Voltage Range:PA "off"		0	0.5	V
Ref current		5	7	mA
V <sub>MODE</sub> High Bias		0	0.5	V
V <sub>MODE</sub> Low Bias	2.5	3	3.1	V
Gain, P <sub>OUT</sub> = 28.5 dBm		28	31.5	dB
Output Power, V <sub>CC</sub> = 3.5V	28	28.5		dBm
Output Power, V <sub>CC</sub> = 3.0V	27	27.5		dBm
Input VSWR			2:1	Ratio
Power Added Efficiency P <sub>OUT</sub> = 28.5 dBm		35		%
Power Added Efficiency V <sub>MODE</sub> = 2.7V P <sub>OUT</sub> = 16 dBm, Low Power Mode	6	7		%
I <sub>cc</sub> (V <sub>MODE</sub> = 2.7V) Low Power Mode		50		mA
<b>Linearity (P<sub>OUT</sub> avg. = 28.5 dBm) &amp; V<sub>CC</sub>=3.5V</b>				
Adjacent Channel Power Rejection @ ±885 KHz offset , Primary Channel Bandwidth=1.23 MHz , Adjacent Channel Bandwidth=30KHz , P <sub>OUT</sub> ≤ 28.5dBm		-48	-46	dBc
Adjacent Channel Power Rejection @ ±1.98 MHz offset , Primary Channel Bandwidth=1.23 MHz , Adjacent Channel Bandwidth=30KHz, P <sub>OUT</sub> ≤ 28.5dBm		-59	-57	dBc
Noise at Receiver Band P <sub>OUT</sub> ≤ 28.5 dBm		-135		dBm/Hz
Harmonics 2fo, P <sub>OUT</sub> = 28.5 dBm		-40	-30	dBc
3fo, P <sub>OUT</sub> = 28.5 dBm		-40	-30	dBc
Stability (out of band load VSWR <8:1) (in band load VSWR <8:1)			-70	dBc, all spurious P <sub>OUT</sub> ≤ 29dBm
Ruggedness Stress for no permanent degradation or failure, V <sub>CC</sub> = 5.0V, Over Temperature	8:1			Ratio

Note: (Unless otherwise specified: V<sub>cc</sub> = 3.5V, Z<sub>IN</sub> = Z<sub>OUT</sub> = 50Ω System, T<sub>C</sub> = 25 °C)

PERFORMANCE DATA

Figure 2

IS-95 Gain & Eff. versus Pout @ 836.5 MHz  
Vcc: 3.0V, Vref: 3.0V, Vmode: 2.7V

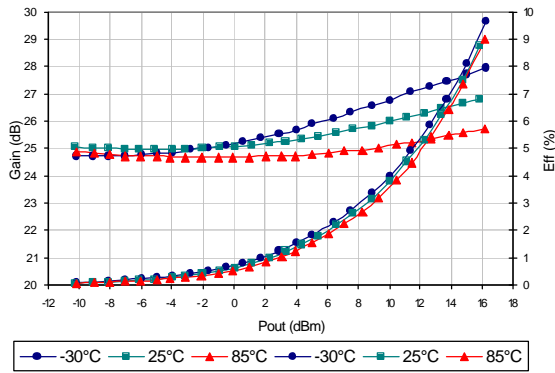

Figure 3

IS-95 Gain & Eff. versus Pout @ 836.5 MHz  
Vcc: 3.0V, Vref: 3.0V, Vmode: 0.0V

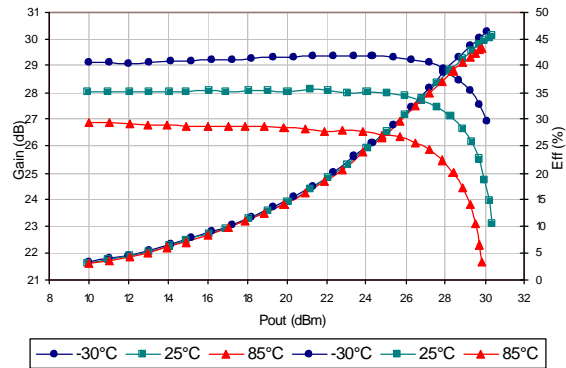

Figure 4

IS-95 Gain & Eff. versus Pout @ 836.5 MHz  
Vcc: 3.5V, Vref: 3.0V, Vmode: 2.7V

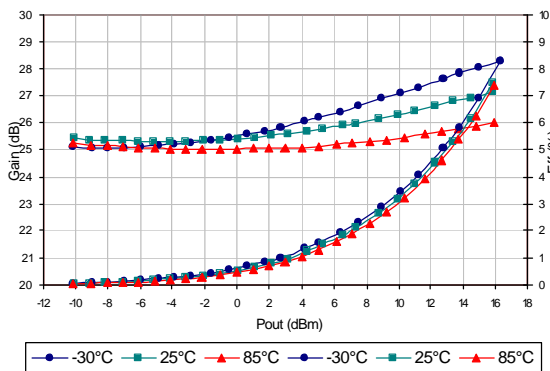

Figure 5

IS-95 Gain & Eff. versus Pout @ 836.5 MHz  
Vcc: 3.5V, Vref: 3.0V, Vmode: 0.0V

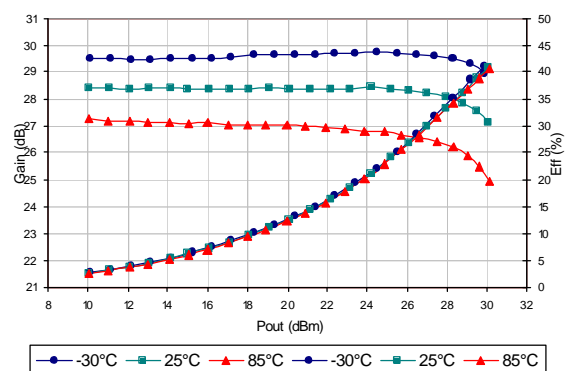

Figure 6

IS-95 Gain & Eff. versus Pout @ 836.5 MHz  
Vcc: 4.2V, Vref: 3.0V, Vmode: 2.7V

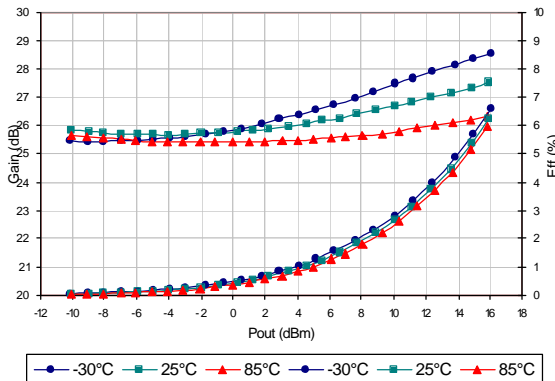
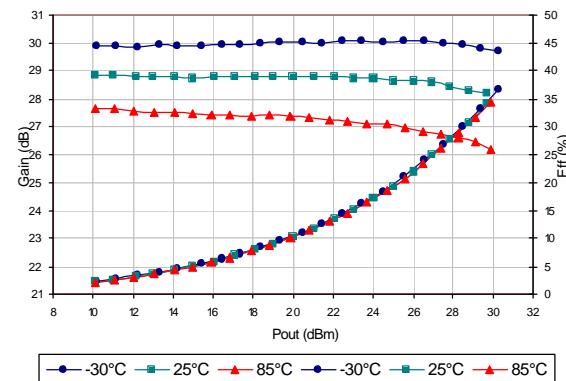

Figure 7

IS-95 Gain & Eff. versus Pout @ 836.5 MHz  
Vcc: 4.2V, Vref: 3.0V, Vmode: 0.0V



AWT6105

Figure 8

ACPR versus Pout @ 836.5 MHz  
Vcc: 3.0V, Vref: 3.0V, Vmode: 2.7V, ACPR: .885 MHz

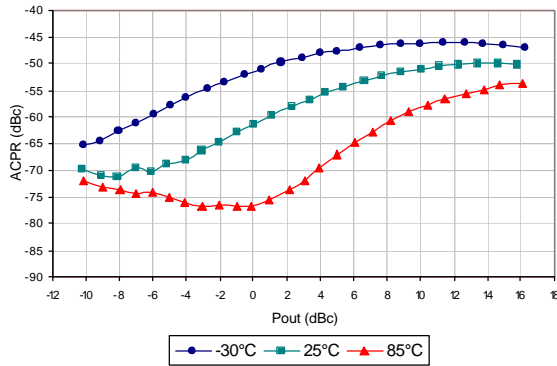

Figure 9

ACPR versus Pout @ 836.5 MHz  
Vcc: 3.0V, Vref: 3.0V, Vmode: 2.7V, ACPR: 1.98 MHz

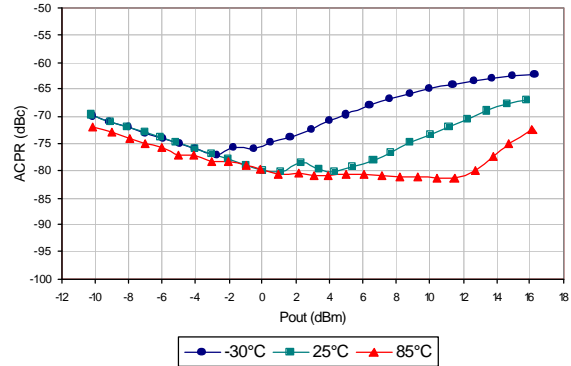

Figure 10

ACPR versus Pout @ 836.5 MHz  
Vcc: 3.0V, Vref: 3.0V, Vmode: 0.0V, ACPR: .885 MHz

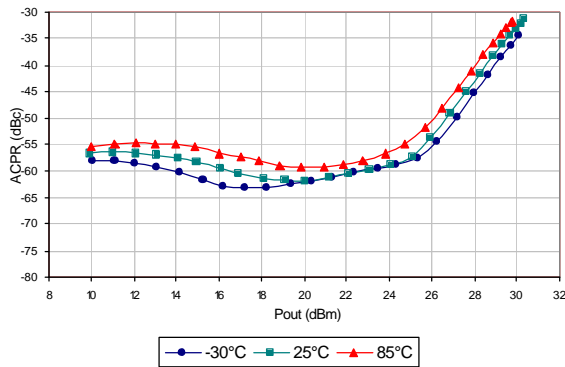

Figure 11

ACPR versus Pout @ 836.5 MHz  
Vcc: 3.0V, Vref: 3.0V, Vmode: 0.0V, ACPR: 1.98 MHz

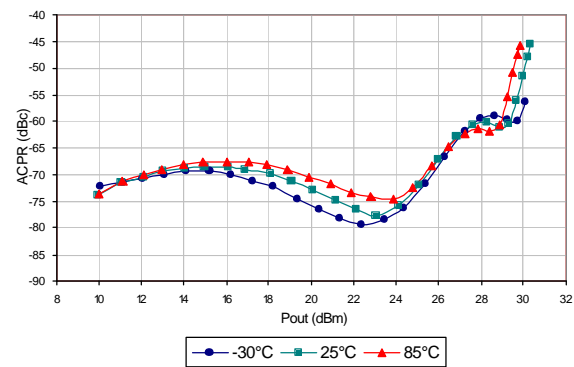

Figure 12

ACPR versus Pout @ 836.5 MHz  
Vcc: 3.5V, Vref: 3.0V, Vmode: 2.7V, ACPR: .885 MHz

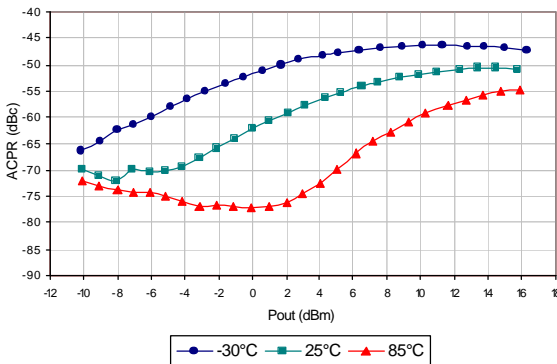
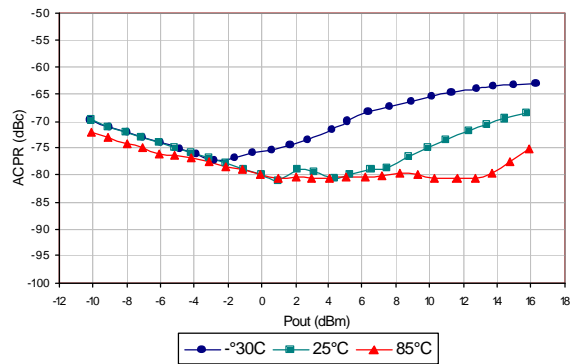

Figure 13

ACPR versus Pout @ 836.5 MHz  
Vcc: 3.5V, Vref: 3.0V, Vmode: 2.7V, ACPR: 1.98 MHz



AWT6105

Figure 14

ACPR versus Pout @ 836.5 MHz  
Vcc: 3.5V, Vref: 3.0V, Vmode: 0.0V, ACPR: .885 MHz

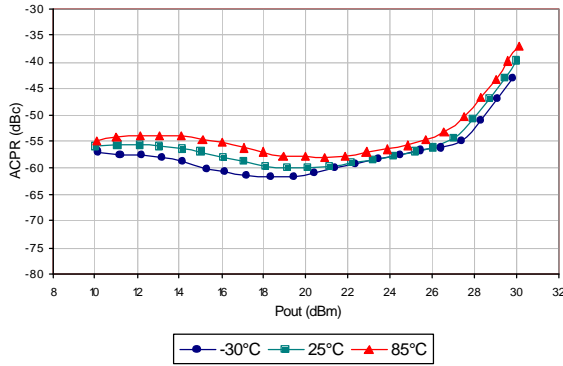

Figure 15

ACPR versus Pout @ 836.5 MHz  
Vcc: 3.5V, Vref: 3.0V, Vmode: 0.0V, ACPR: 1.98 MHz

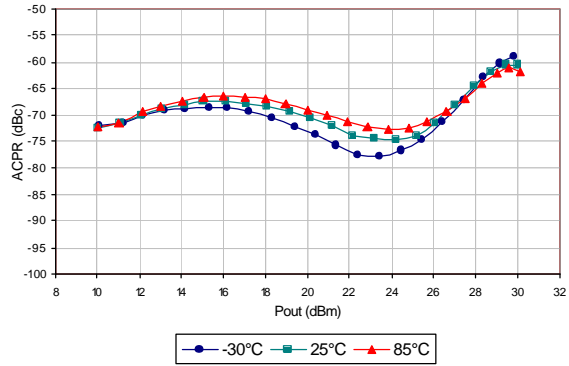

Figure 16

ACPR versus Pout @ 836.5 MHz  
Vcc: 4.2V, Vref: 3.0V, Vmode: 2.7V, ACPR: .885 MHz

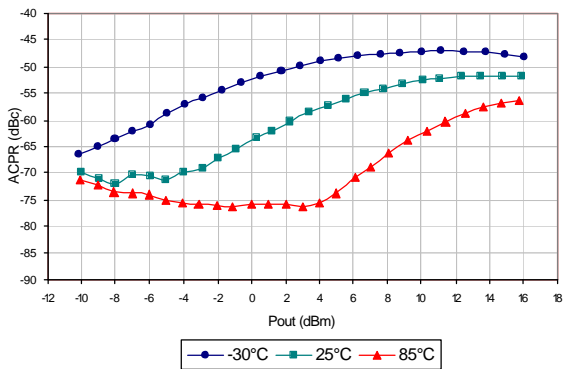

Figure 17

ACPR versus Pout @ 836.5 MHz  
Vcc: 4.2V, Vref: 3.0V, Vmode: 2.7V, ACPR: 1.98 MHz

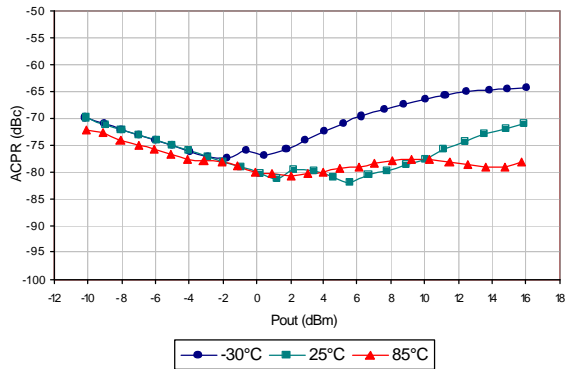

Figure 18

ACPR versus Pout @ 836.5 MHz  
Vcc: 4.2V, Vref: 3.0V, Vmode: 0.0V, ACPR: .885 MHz

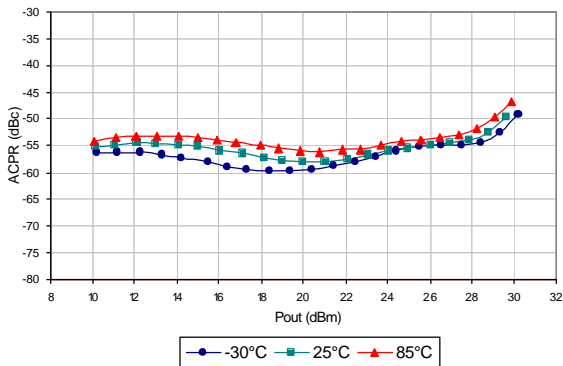
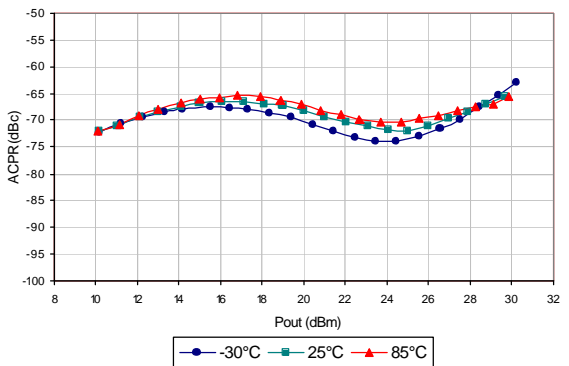

Figure 19

ACPR versus Pout @ 836.5 MHz  
Vcc: 4.2V, Vref: 3.0V, Vmode: 0.0V, ACPR: 1.98 MHz



**AWT6105**

**AMPS MODE:**

**Figure 20**

Gain & Eff. versus Pout @ 836.5 MHz  
Vcc: 3.0V, Vref: 3.0V, Vmode: 2.7V

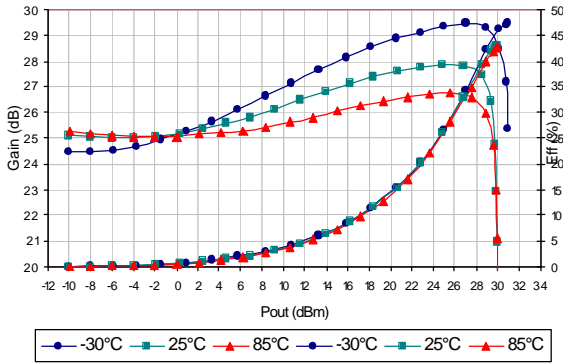

**Figure 21**

Gain & Eff. versus Pout @ 836.5 MHz  
Vcc: 3.5V, Vref: 3.0V, Vmode: 2.7V

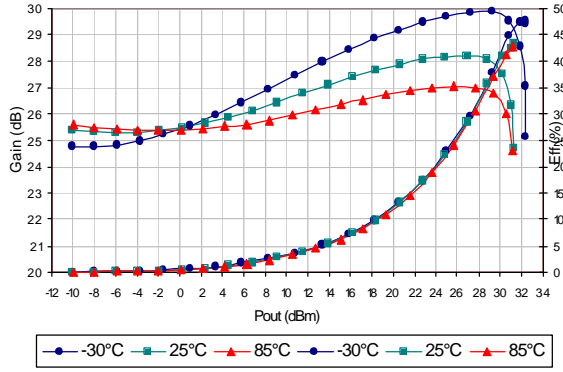

**Figure 22**

Gain & Eff. versus Pout @ 836.5 MHz  
Vcc: 4.2V, Vref: 3.0V, Vmode: 2.7V

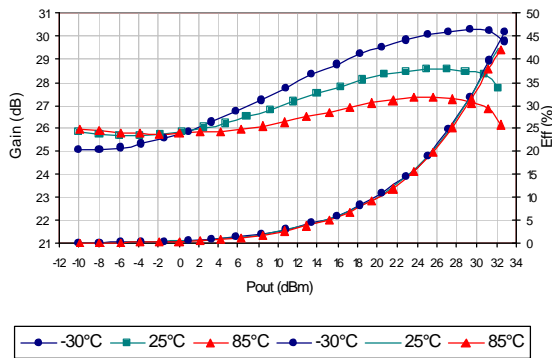



**Figure 23**

IS-98D Gain & Eff. versus Pout @ 836.5 MHz  
Vcc: 3.0V, Vref: 3.0V, Vmode: 2.7V

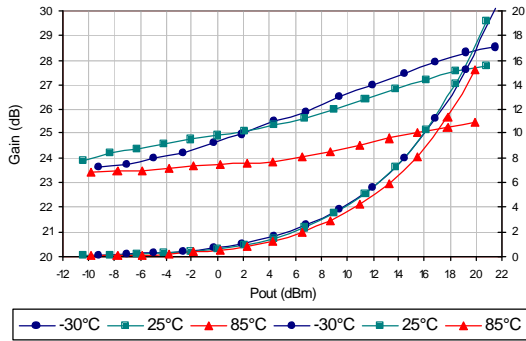

**Figure 24**

IS-98D Gain & Eff. versus Pout @ 836.5 MHz  
Vcc: 3.0V, Vref: 3.0V, Vmode: 0.0V

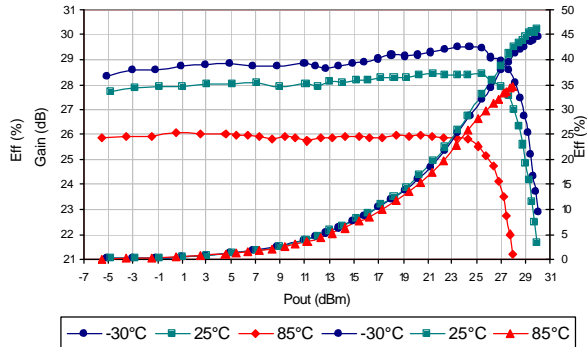

**Figure 25**

IS-98D Gain & Eff. versus Pout @ 836.5 MHz  
Vcc: 3.5V, Vref: 3.0V, Vmode: 2.7V

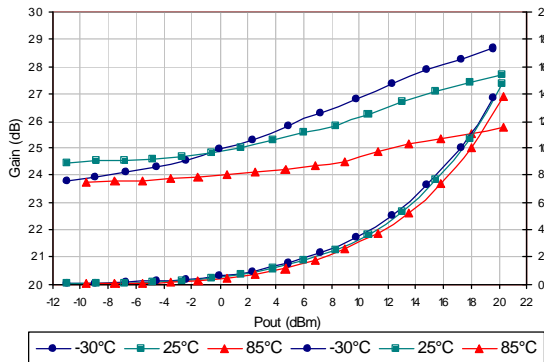

**Figure 26**

IS-98D Gain & Eff. versus Pout @ 836.5 MHz  
Vcc: 3.5V, Vref: 3.0V, Vmode: 0.0V

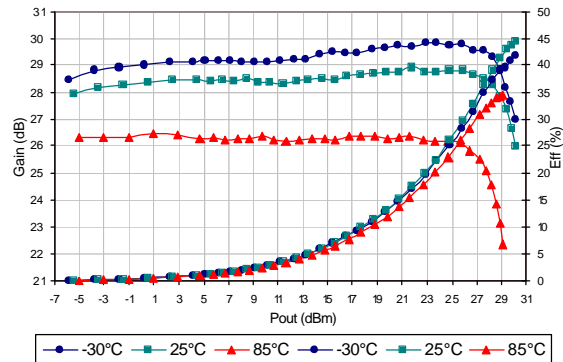

**Figure 27**

IS-98D Gain & Eff. versus Pout @ 836.5 MHz  
Vcc: 4.2V, Vref: 3.0V, Vmode: 2.7V

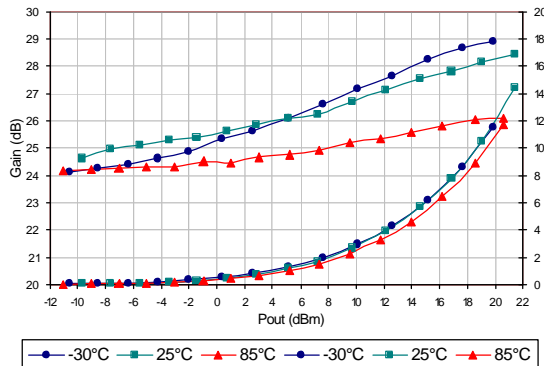

**Figure 28**

IS-98D Gain & Eff. versus Pout @ 836.5 MHz  
Vcc: 4.2V, Vref: 3.0V, Vmode: 0.0V

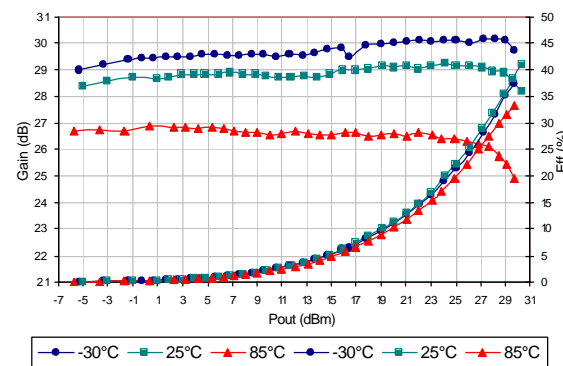

**AWT6105**

**Figure 29**

IS-98D ACPR versus Pout @ 836.5 MHz  
 Vcc: 3.0V, Vref: 3.0V, Vmode: 2.7V, ACPR: .885 MHz

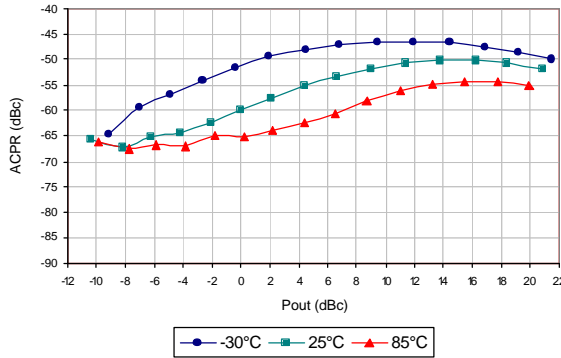

**Figure 30**

IS-98D ACPR versus Pout @ 836.5 MHz  
 Vcc: 3.0V, Vref: 3.0V, Vmode: 2.7V, ACPR: 1.98 MHz

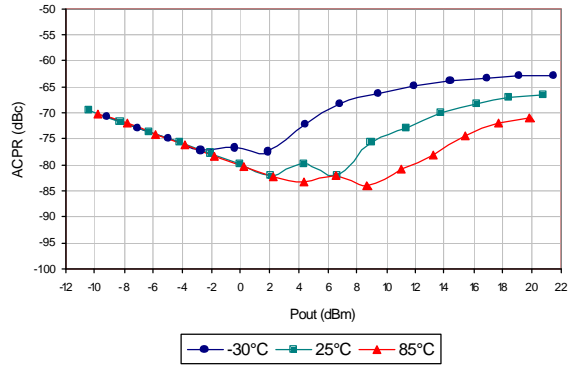

**Figure 31**

IS-98D ACPR versus Pout @ 836.5 MHz  
 Vcc: 3.0V, Vref: 3.0V, Vmode: 0.0V, ACPR: .885 MHz

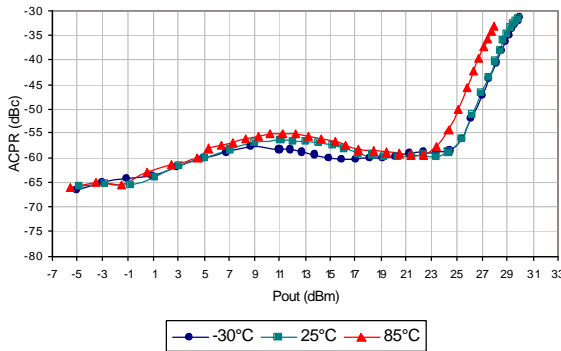

**Figure 32**

IS-98D ACPR versus Pout @ 836.5 MHz  
 Vcc: 3.0V, Vref: 3.0V, Vmode: 0.0V, ACPR: 1.98 MHz

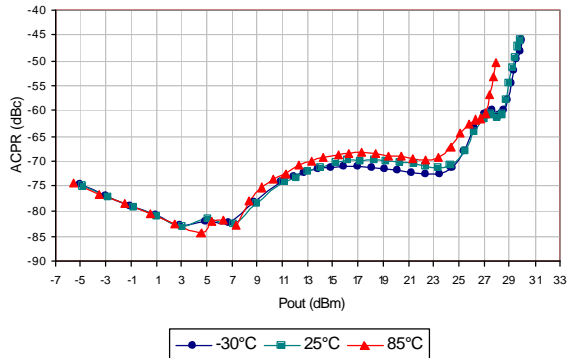

**Figure 33**

IS-98D ACPR versus Pout @ 836.5 MHz  
 Vcc: 3.5V, Vref: 3.0V, Vmode: 2.7V, ACPR: .885 MHz

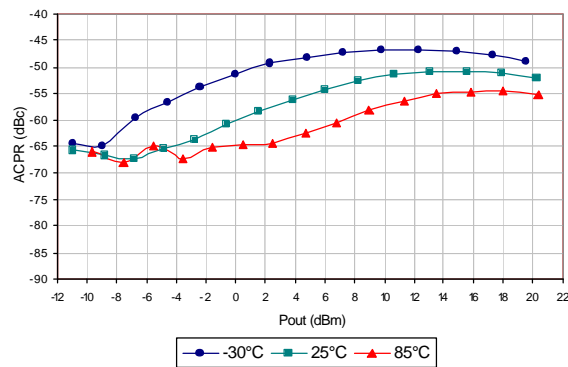

**Figure 34**

IS-98D ACPR versus Pout @ 836.5 MHz  
 Vcc: 3.5V, Vref: 3.0V, Vmode: 2.7V, ACPR: 1.98 MHz

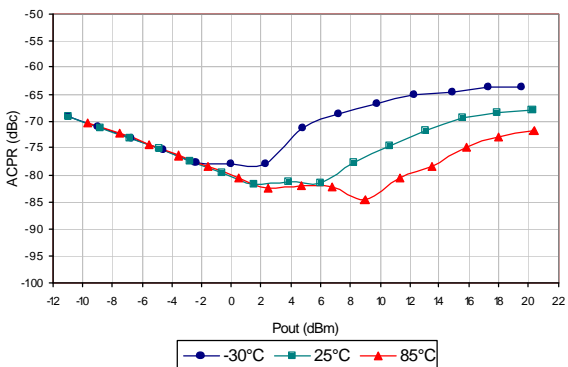

AWT6105

Figure 35

IS-98D ACPR versus Pout @ 836.5 MHz  
Vcc: 3.5V, Vref: 3.0V, Vmode: 0.0V, ACPR: .885 MHz

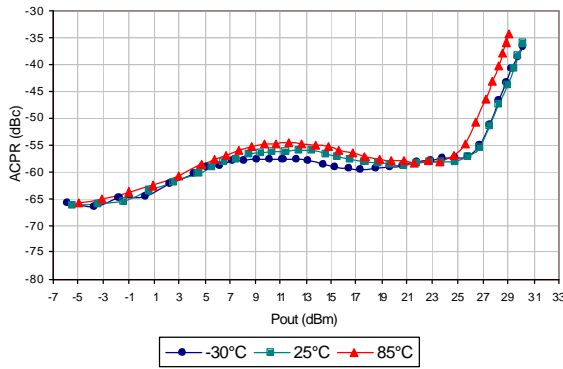

Figure 36

IS-98D ACPR versus Pout @ 836.5 MHz  
Vcc: 3.5V, Vref: 3.0V, Vmode: 0.0V, ACPR: 1.98 MHz

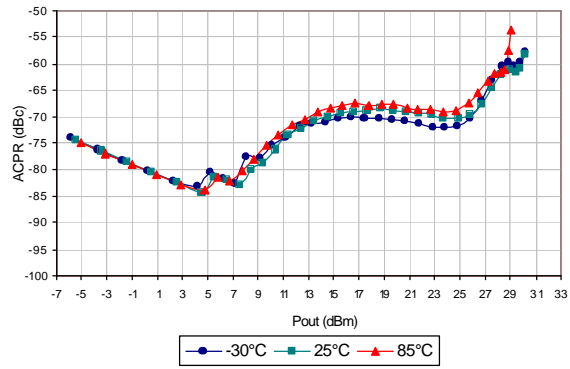

Figure 37

IS-98D ACPR versus Pout @ 836.5 MHz  
Vcc: 4.2V, Vref: 3.0V, Vmode: 2.7V, ACPR: .885 MHz

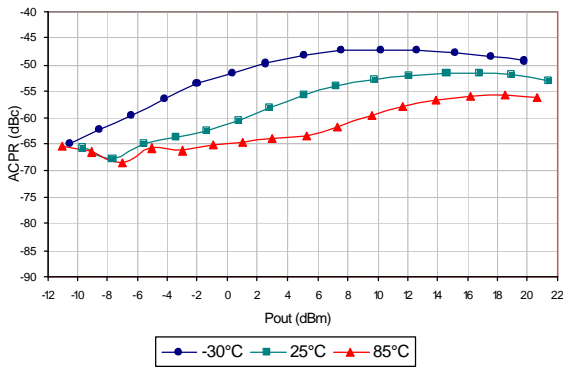

Figure 38

IS-98D ACPR versus Pout @ 836.5 MHz  
Vcc: 4.2V, Vref: 3.0V, Vmode: 2.7V, ACPR: 1.98 MHz

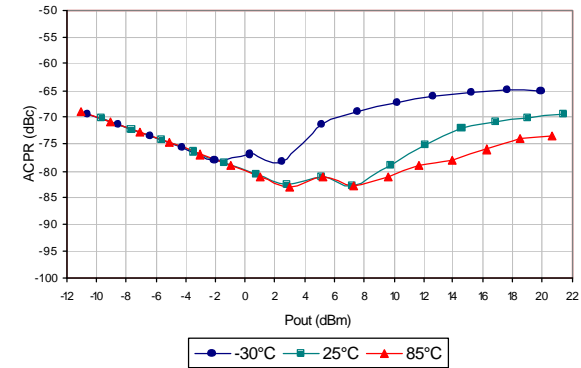

Figure 39

IS-98D ACPR versus Pout @ 836.5 MHz  
Vcc: 4.2V, Vref: 3.0V, Vmode: 0.0V, ACPR: .885 MHz

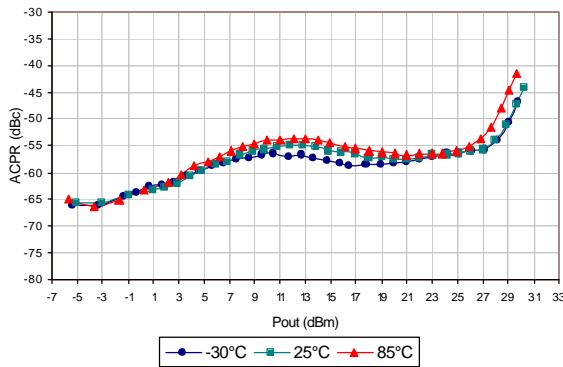
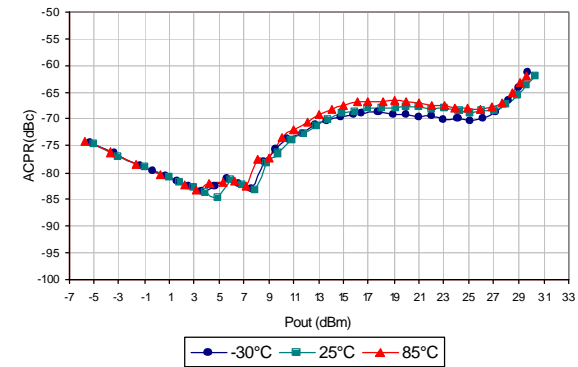

Figure 40

IS-98D ACPR versus Pout @ 836.5 MHz  
Vcc: 4.2V, Vref: 3.0V, Vmode: 0.0V, ACPR: 1.98 MHz



AWT6105

PACKAGE OUTLINE

SCALE= 6:1

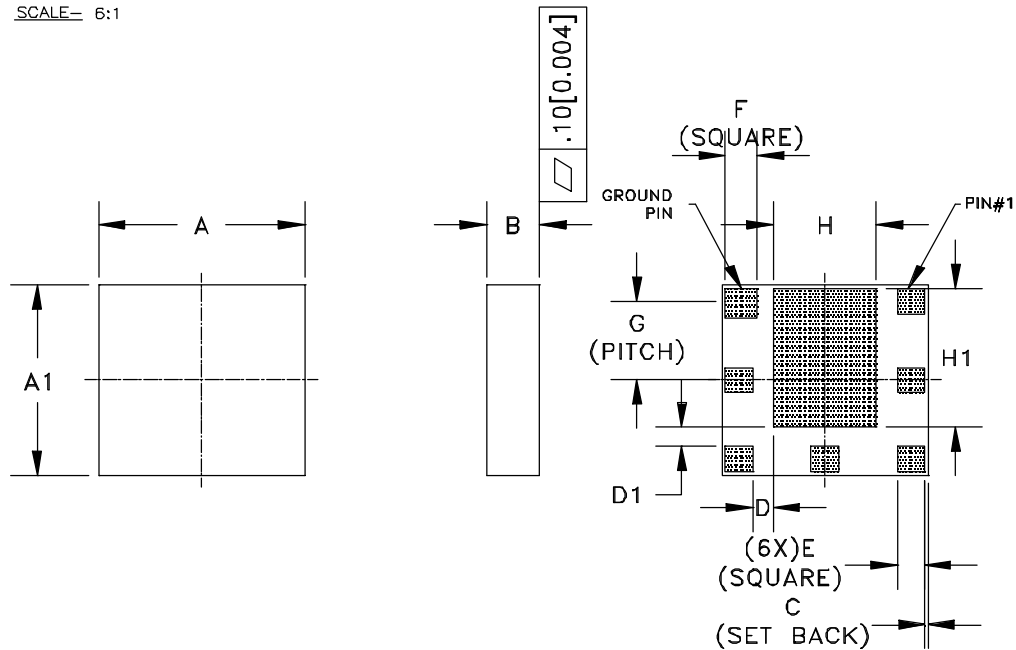

DIM.	MILLIMETERS			INCHES			NOTE
	MIN.	NOM.	MAX.	MIN.	NOM.	MAX.	
A	5.88	6.00	6.12	0.231	0.236	0.241	—
A1	5.88	6.00	6.12	0.231	0.236	0.241	—
B	1.30	1.50	1.70	0.051	0.059	0.067	—
C	0.05	—	—	0.002	—	—	—
D	—	0.60	—	—	0.024	—	3
D1	—	0.60	—	—	0.024	—	3
E	—	0.81	—	—	0.032	—	3
F	—	0.89	—	—	0.035	—	3
G	2.5 BSC			0.098 BSC			3
H	—	3.00	—	—	0.118	—	3
H1	—	4.39	—	—	0.173	—	3

NOTES:

1. CONTROLLING DIMENSIONS: MILLIMETERS
2. UNLESS SPECIFIED TOLERANCE=±0.05[0.003].
3. FOR REFERENCE ONLY.

Figure 41: Package Outline Drawing (Low Band M5)

AWT6105

COMPONENT PACKAGING

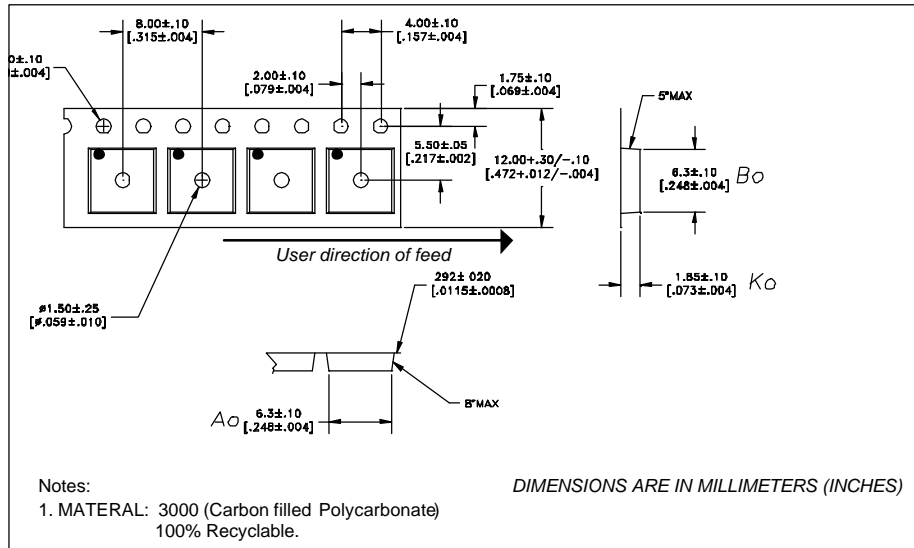

Figure 42: Tape & Reel Packing Specifications

PACKAGE TYPE	TAPE WIDTH	POCKET PITCH	REEL CAPACITY	MAX REEL DIA
6 X 6	12	8	2500	13"



BRANDING SPECIFICATION

NOTES:

- ANADIGICS LOGO SIZE: X=0.080±0.010 Y=0.095±0.010
  - PART # AWT6105
  - YEAR AND WORK WEEK. YYWW: YY = YEAR, WW = WORK WEEK
  - LOT - Wafer Lot ID LLLLL
  - PIN 1 INDICATOR: MOLD NOTCH -or- INK DOT
  - BOM # 001
  - COUNTRY CODE: CCCCC
- B. TYPE : ELITE  
SIZE : AS LARGE AS POSSIBLE  
COLOR : WHITE or SILVER

Figure 43: Branding Specification

**AWT6105**

**NOTES**

**AWT6105**

**NOTES**

AWT6105

**ORDERING INFORMATION**

ORDER NUMBER	PACKAGE DESCRIPTION	COMPONENT PACKAGING
AWT6105M5	M5	6x6 Module Package



**ANADIGICS, Inc.**  
 141 Mount Bethel Road  
 Warren, New Jersey 07059, U.S.A.  
 Tel: +1 (908) 668-5000  
 Fax: +1 (908) 668-5132

URL: <http://www.anadigics.com>  
 E-mail: [Mktg@anadigics.com](mailto:Mktg@anadigics.com)

**IMPORTANT NOTICE**

ANADIGICS, Inc. reserves the right to make changes to its products or to discontinue any product at any time without notice. The product specifications contained in Advanced Product Information sheets and Preliminary Data Sheets are subject to change prior to a product's formal introduction. Information in Data Sheets have been carefully checked and are assumed to be reliable; however, ANADIGICS assumes no responsibilities for inaccuracies. ANADIGICS strongly urges customers to verify that the information they are using is current before placing orders.

**WARNING**

ANADIGICS products are not intended for use in life support appliances, devices or systems. Use of an ANADIGICS product in any such application without written consent is prohibited.