

2A PWM Buck DC/DC Converter

❖ GENERAL DESCRIPTION

The AX3015/A/B/C series are monolithic IC designed for a step-down DC/DC converter, and own the ability of driving a 2A load without additional transistor. It saves board space. The external shutdown function can be controlled by logic level and then come into standby mode. The internal compensation makes feedback control having good line and load regulation without external design. Regarding protected function, thermal shutdown is to prevent over temperature operating from damage; current limit is against over current operating of the output switch that set by outside resistance. Current limit depends on R_{SENSE} value. The over voltage protection (OVP) that can avoid high V_{OUT} voltage to damage circuit and capacitor, the OVP voltage is set by outside resistances. When SCP happened and $V_{ENCT} > 0.5V$, the driver can be auto restart that can prevent driver damage. The auto-restart time set by outside capacitor. The chip is available in SOP-8L-EP package which features small size as exposed pad to reduce the junction-to-case resistance.

❖ FEATURES

- Operating voltage can be up to 40V.
- Adjustable version output voltage range form 1.2V to 30V.
- Output load current: 2A.
- External OVP setting function.
- Operating Frequency:
AX3015/A: 130KHz
AX3015B/C: 50KHz
- Voltage mode non-synchronous PWM converter
- Thermal-shutdown and current-limit protection.
- Shutdown function and auto restart control.
- Short Circuit Protect (SCP).
- External current limit setting.
- Under voltage Lockout.
- SOP-EP Pb-Free package.
- Built-in switching transistor on chip.

❖ BLOCK DIAGRAM

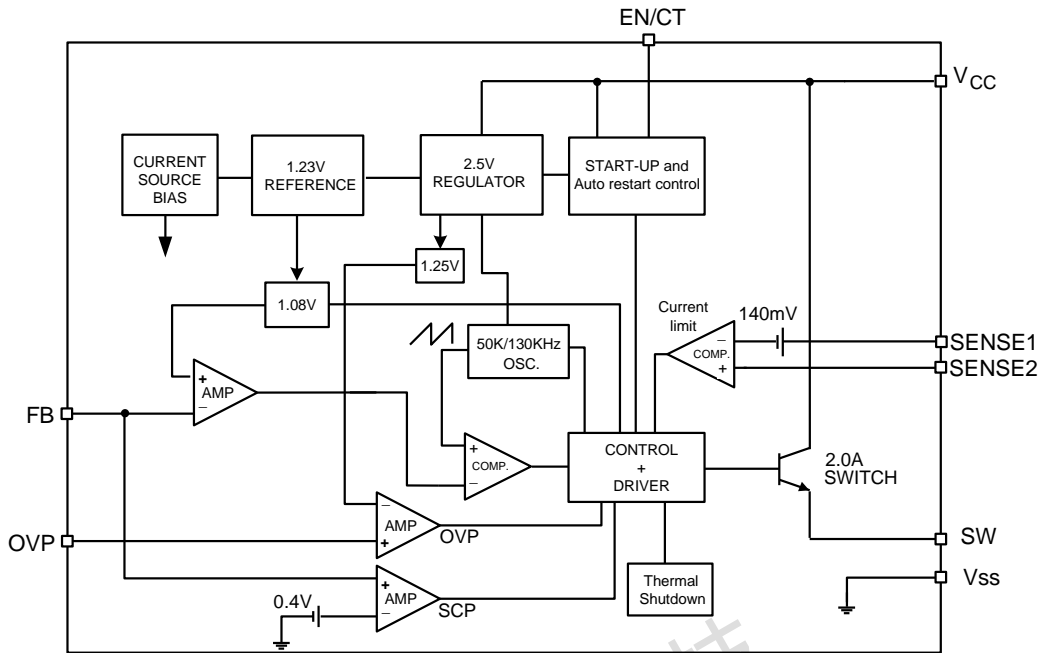

❖ PIN ASSIGNMENT

The package of AX3015/A/B/C is SOP-8L-EP; the pin assignment is given by:

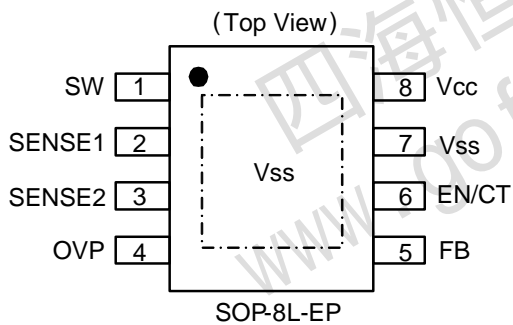

Name	Description
V _{CC}	Operating voltage input
V _{SS}	GND pin
FB	Output voltage feedback control
SW	Switch pin. Connect external inductor and diode here
SENSE1	Current Sense input1
SENSE2	Current Sense input2
EN/CT	Shutdown and auto restart control pin
OVP	Over voltage detect pin

❖ ORDER/MARKING INFORMATION

Order Information	Top Marking
<p>AX3015 X X X</p> <p>Frequency/Line Comp. Blank: 130KHz / 200mV A: 130KHz / 0mV B: 50KHz / 200mV C: 50KHz / 0mV</p> <p>Package Type ES: SOP-8L-EP</p> <p>Packing Blank : Tube A : Taping</p>	<p>Logo ← AX 3 0 1 5 → Part number X Y Y W W X → ID code:internal</p> <p>Blank: AX3015 A : AX3015A B : AX3015B C : AX3015C</p> <p>WW: 01~52 Year: 10=2010 11=2011</p>

❖ ABSOLUTE MAXIMUM RATINGS

Characteristics	Symbol	Rating	Unit
Maximum Supply Voltage	V _{CC}	+45	V
EN/CT, OVP Pin Input Voltage		-0.3 to 6	V
Feedback Pin Voltage	V _{FB}	-0.3 to 12	V
SW Pin Voltage	V _{SW}	-0.3 to V _{CC}	V
SENSE Pin Voltage	V _{SENSE1/2}	-0.3 to 32	V
Power Dissipation Internally limited	PD	(T _J -T _A) / θ _{JA}	W
Storage Temperature Range	T _{ST}	-65 to +150	°C
Operating Temperature Range	T _{OP}	-40 to +125	°C
Operating Supply Voltage	V _{OP}	8 to 40	V
Thermal Resistance from Junction to case	θ _{JC}	15	°C/W
Thermal Resistance from Junction to ambient	θ _{JA}	40	°C/W

Note: θ_{JA} is measured with the PCB copper area(need connect to Exposed Pad) of approximately 1in² (Multi-layer).

❖ ELECTRICAL CHARACTERISTICS

(Unless otherwise specified, T_A=25°C, V_{CC}=12V, V_{OUT}=5V, I_{OUT} = 0.2A)

Characteristics	Symbol	Conditions	Min	Typ	Max	Units	
Feedback Voltage	V _{FB}	I _{OUT} =10mA	1.069	1.080	1.091	V	
Under Voltage Lockout	U _{VLO}	Falling	-	6	-	V	
UVLO Hysteresis			-	0.8	-	V	
OVP detect voltage	V _{OVP}		1.225	1.25	1.275	V	
Feedback bias current	I _{FB}	V _{FB} =1.5V	-	-30	-	nA	
Line Regulation		V _{CC} =10~30V, I _{OUT} =30mA	-	0.5	1	%	
Load Regulation		I _{OUT} =0~1A, V _{OUT} =5V R _{SENSE} =0.1Ω	AX3015A/C	-	-5	-25	mV
			AX3015/B	+150	+200	-	
Quiescent Current	I _{CCQ}	V _{FB} =2V force driver off	-	3	6	mA	
Oscillator frequency	F _{OSC}	AX3015/A	115	130	155	KHz	
		AX3015B/C	40	50	60		
Max. Duty Cycle (ON)	DC	V _{FB} =0.6V force driver on	-	100	-	%	
Min. Duty Cycle (OFF)		V _{FB} =1.5V force driver off	-	0	-		
Saturation voltage	V _{SAT}	No outside circuit V _{FB} =0.8V force driver on	I _{OUT} =2A	-	1.15	1.3	V
			I _{OUT} =1A	-	0.9	1.1	V
Sense Voltage	V _{SENSE}	V _{SENSE1} -V _{SENSE2}	-	140	-	mV	
Sense Voltage Hysteresis	V _{SENSE-h}		-	30	-	mV	
SW pin leakage current SW pin=0V	I _{SWL}	No outside circuit V _{FB} =1.5V force driver off	-	-	-200	uA	

SW pin leakage current SW pin=-0.8V		V _{CC} =40V force driver off	-	-5	-	mA
EN/CT pin logic input threshold voltage	V _{EN1}	Shutdown mode	-	-	0.3	V
	V _{CT}	Auto restart, V _{FB} <0.4V	0.5	-	1.5	
	V _{EN2}	Operating mode	1.6	-	-	
EN/CT pin current	I _{EN/CT}	Charge current	-	-30	-	uA
EN/CT pin current	I _{EN/CT}	Discharge current	-	1.3	-	uA
Thermal shutdown Temp	T _{SD}		-	160	-	°C
Thermal Shutdown Hysteresis	T _{SH}		-	45	-	°C

❖ APPLICATION CIRCUIT

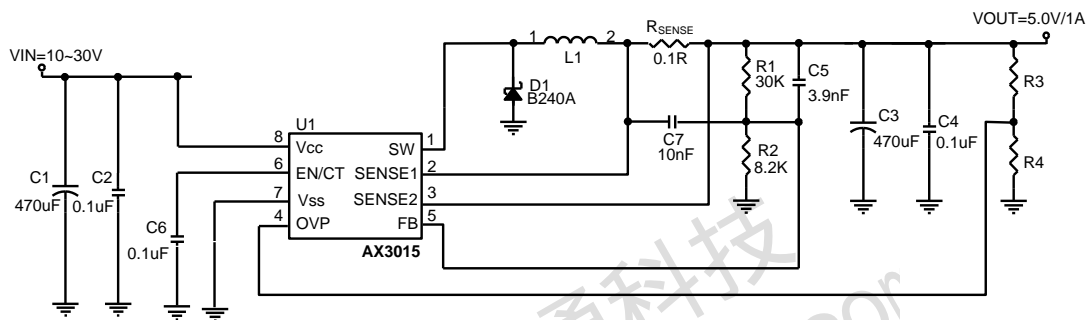

$$V_{OUT} = V_{FB} \times \left(1 + \frac{R1}{R2}\right), V_{FB} = 1.08V, R2 = 5K \sim 15K$$

$$V_{OUT(OVP)} = V_{OVP} \times \left(1 + \frac{R1}{R2}\right), V_{FB} = 1.25V, R4 = 5K \sim 15K$$

❖ FUNCTION DESCRIPTIONS

FB

Sense the regulated output voltage to complete the feedback loop, moreover, the external OVP and SCP sense voltage. If $V_{FB} > 1.25V$, the OVP is happened that it can turn-off the driver, when $V_{FB} < 0.4V$ and $V_{EN/CT} \geq 0.4V$, the SCP is happened that it can auto restart driver.

SENSE1/2

The current limit sense pin, if $V_{SENSE1} - V_{SENSE2} \geq 140mV$, the over current is happened that it can turn-off driver cycle by cycle.

OVP

The Over Voltage sense pin, If $V_{OVP} > 1.25V$, the OVP is happened that it can turn-off the driver. You can set V_{OUT} OVP voltage by outside resistances ($R3$ and $R4$), Please see below formula to set.

$$V_{OUT}_{(OVP)} = 1.25 \times \left(1 + \frac{R3}{R4}\right)$$

EN/CT

The pin is enable/shutdown and auto restart control functions. When system is normal operating, this pin is enable/shutdown function. Pulling this pin below a threshold voltage of under $0.3V$ shuts the regulator off, and pulling this pin from $0.5V$ to $1.5V$ turns the regulator on. However when V_{OUT} is short ($V_{FB} < 0.4V$), the auto restart function can be started that restart the regulator cycle by cycle. The cycle time is set by outside capacitor ($C6$). Please refer the below waveform and formula, the $t2$ cycle is regulator off time and $t1$ cycle is current limit time. The charge-current is $30\mu A$ and discharge-current is $1.3\mu A$.

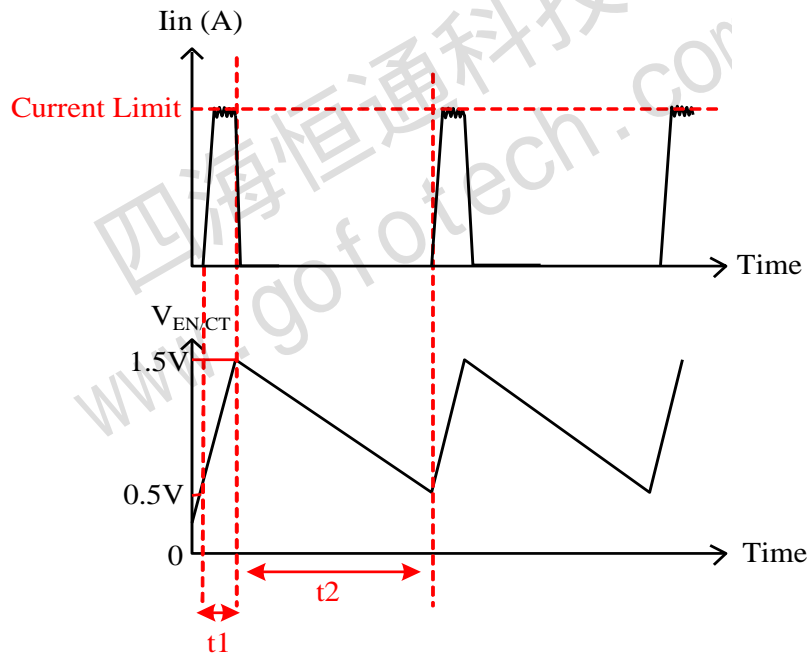

$$t1 = C6 \times \frac{1}{30\mu} (Sec.)$$

$$t2 = C6 \times \frac{1}{1.3\mu} (Sec.)$$

Under Voltage Lockout (UVLO)

To avoid mis-operation of the device at low input voltages an under voltage lockout is included that disables the device, if the input voltage falls below 6.0 V.

❖ APPLICATION INFORMATION

Setting the Output Voltage

Application circuit item shows the basic application circuit with adjustable output version. The external resistor sets the output voltage according to the following equation:

$$V_{OUT} = 1.08V \times \left(1 + \frac{R1}{R2}\right)$$

Table 1 Resistor select for output voltage setting

V _{OUT}	R2	R1
5.03V	8.2K	30K
3.32V	13K	27K

Current Limit Protection

The Current limit is set by outside resistance (R_{SENSE}), When the SENSE1-SENSE2 voltage larger than 140mV, the current limit is happened that driver can be turned off until the drop is small than 110mV. The current limit set according to the following equation:

$$\text{Current Limit (A)} = \frac{140m}{R_{SENSE}}$$

The maximum output current table is shown as below; please refer the table to design.

RSENSE (Ω)	Current Limit (A)	Maximum Output Current (A)
100m	1.4	1.1
150m	0.93	0.7
200m	0.7	0.5

Line Compensation (AX3015 and AX3015B only)

The function is designed in order to compensate the output line loss, especially in heavy load. The AX3015/B's load regulation is positive; the V_{OUT} voltage can be raised by output current. For example, $V_{FB}=1.08V$ in $I_{OUT}=0A$, When I_{OUT} increase to 1A, the V_{FB} can be rise to about 1.123V.

Inductor Selection

For most designs, the different frequency can be reducing the inductor value; The AX3015 is suggested 68 μ H to 120 μ H for 50K to 130KHz frequencies. Please refer the below table to design.

L1 recommend value ($V_{IN}=10\sim 30V$, $V_{OUT}=5V$, $I_{OUT}=1A$)				
Version	AX3015	AX3015A	AX3015B	AX3015C
L1 Value (H)	68u~100u	68u~100u	100u~120u	100u~120u

Where is inductor Ripple Current. Large value inductors lower ripple current and small value inductors result in high ripple currents. Choose inductor ripple current approximately 20% of the maximum load current 2A, $\Delta L=0.4A$. The DC current rating of the inductor should be at least equal to the maximum load current plus half the ripple current to prevent core saturation (2A+0.2A).

Input Capacitor Selection

This capacitor should be located close to the IC using short leads and the voltage rating should be approximately 1.5 times the maximum input voltage. The RMS current rating requirement for the input capacitor of a buck regulator is approximately 1/2 the DC load current. A low ESR input capacitor sized for maximum RMS current must be used. A 470 μ F low ESR capacitor for most applications is sufficient.

Output Capacitor Selection

The output capacitor is required to filter the output and provide regulator loop stability. The important capacitor parameters are; the 100 KHz Equivalent Series Resistance (ESR), the RMS ripples current rating, voltage rating, and capacitance value. For the output capacitor, the ESR value is the most important parameter. The ESR can be calculated from the following formula.

$$V_{RIPPLE} = \Delta I_L \times ESR = 0.4A \times 80m\Omega = 32mV$$

An aluminum electrolytic capacitor's ESR value is related to the capacitance and its voltage rating. In most case, higher voltage electrolytic capacitors have lower ESR values. Most of the time, capacitors with much higher voltage ratings may be needed to provide the low ESR values required for low output ripple voltage. System stability is depending on output capacitor's ESR, Correct to choose output capacitor's ESR is very important. It is recommended to using a 220~470 μ F, the ESR values range is 40~130m Ω .

Thermal Considerations

The SOP-8L-EP package needs a heat sink under most conditions. The heat sink connect exposed pad of AX3015 to obtain best effect. The size of the heat sink depends on the input voltage, the output voltage, the load current and the ambient temperature.

四海恒通科技
www.gofotech.com

❖ TYPICAL CHARACTERISTICS

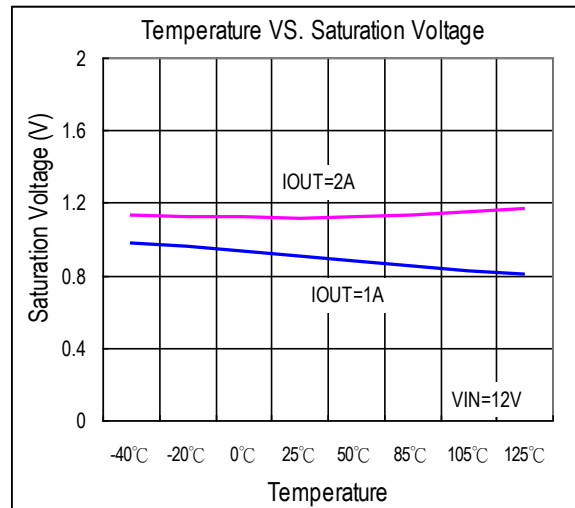
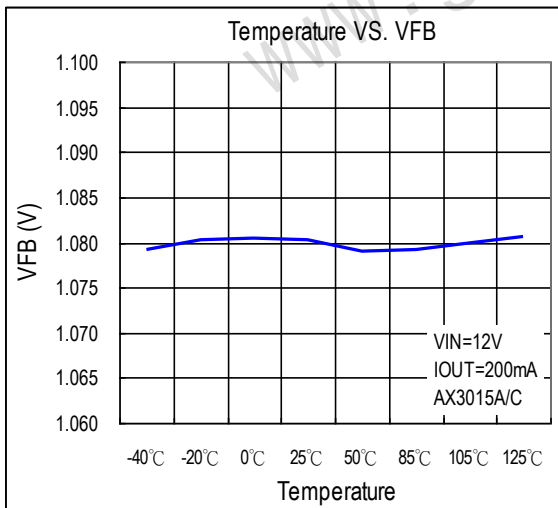
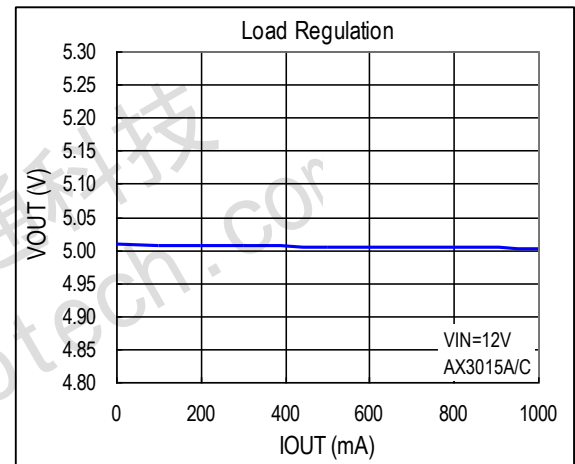
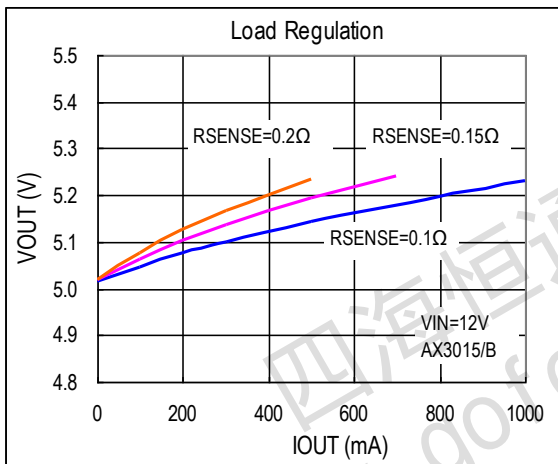
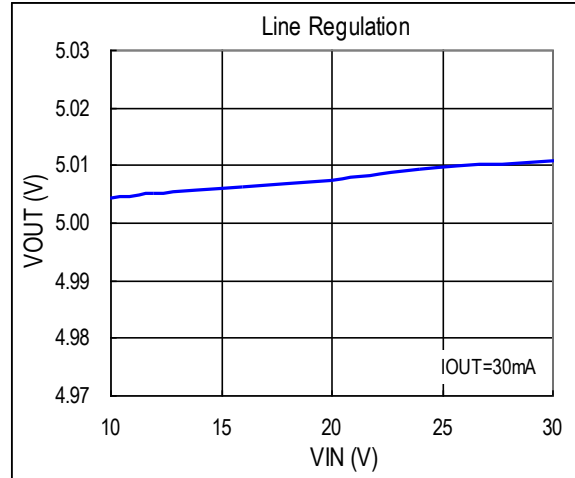
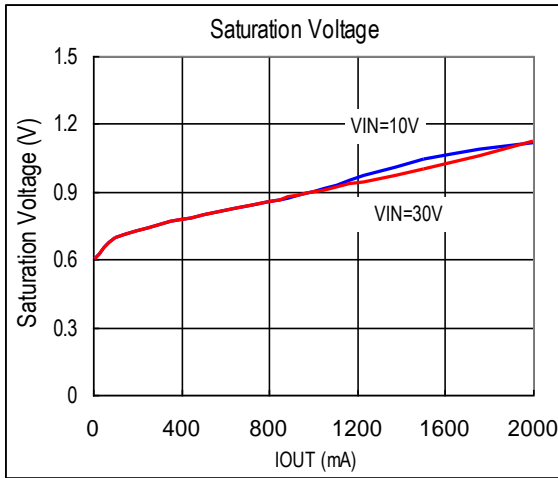

❖ TYPICAL CHARACTERISTICS (COUNTINOUS)

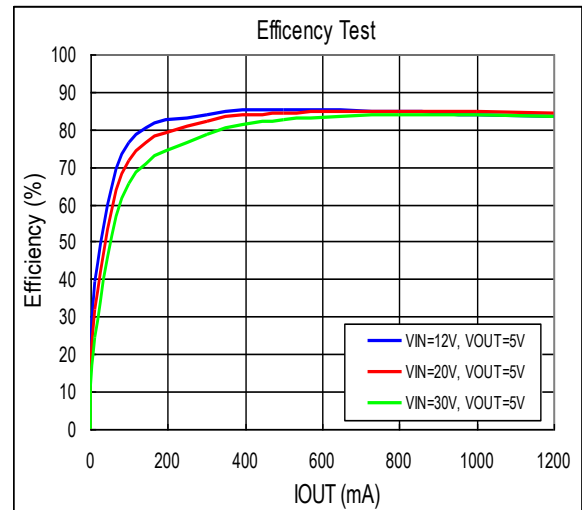
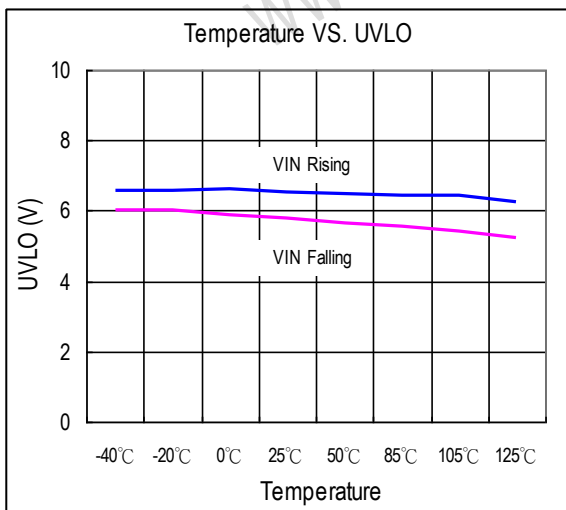
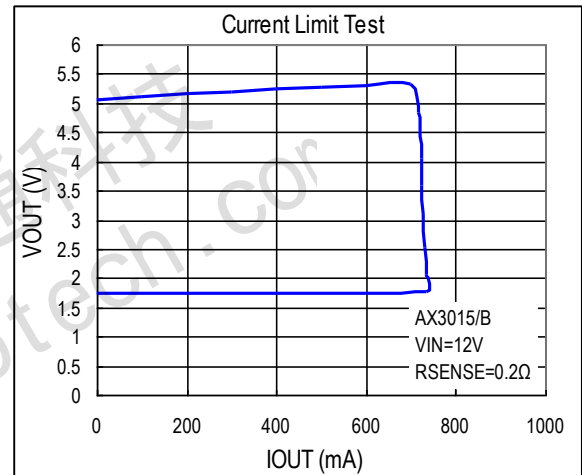
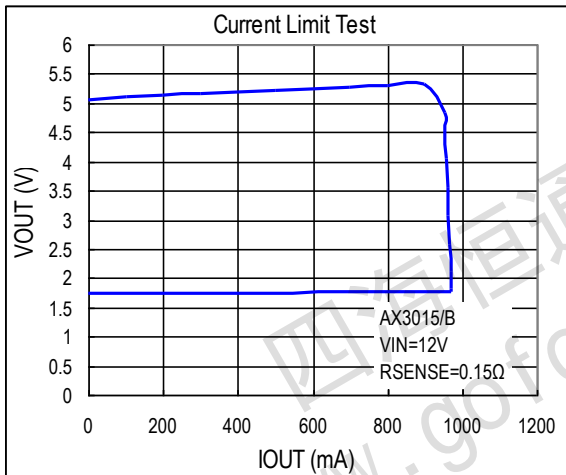
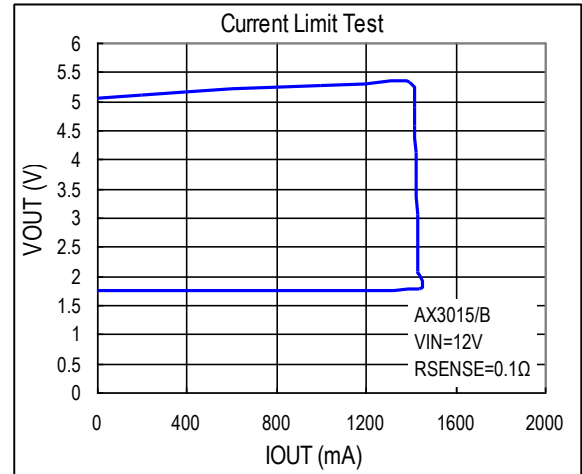
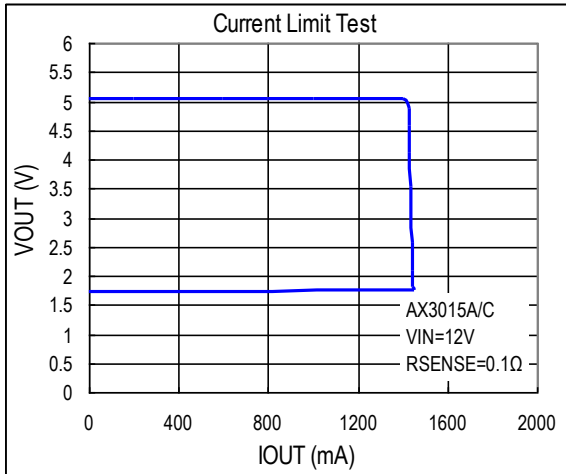

❖ TYPICAL CHARACTERISTICS (COUNTINOUS)

Power-ON

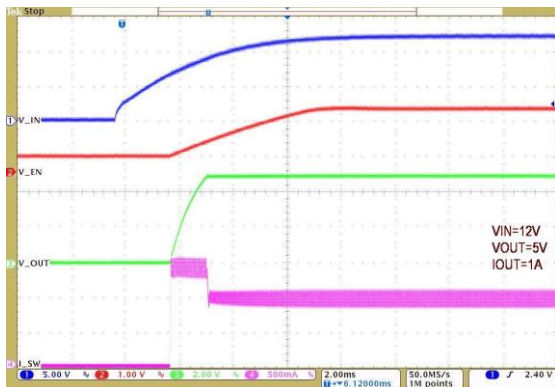

Power-ON

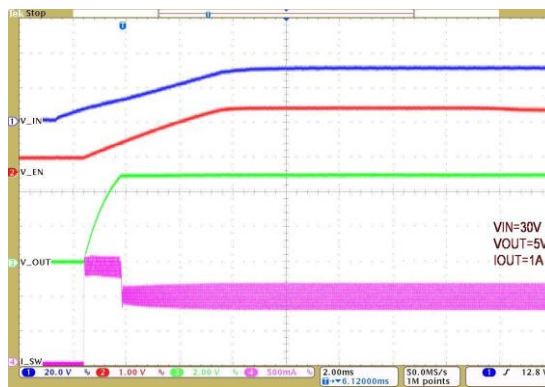

EN-ON

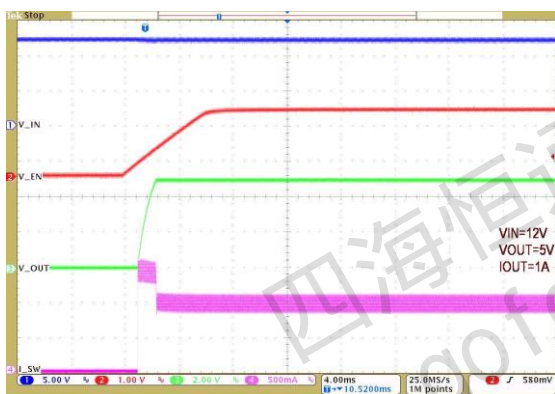

EN-ON



Load Transient (AX3015)

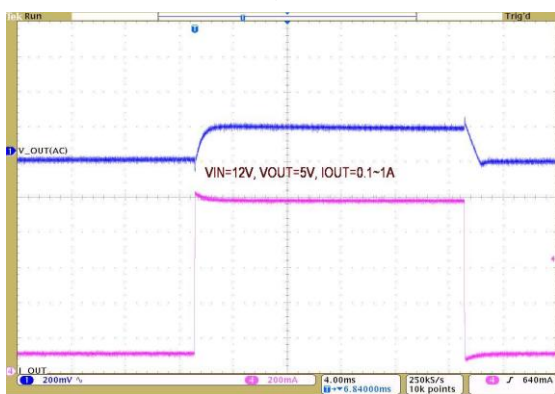

Load Transient (AX3015)

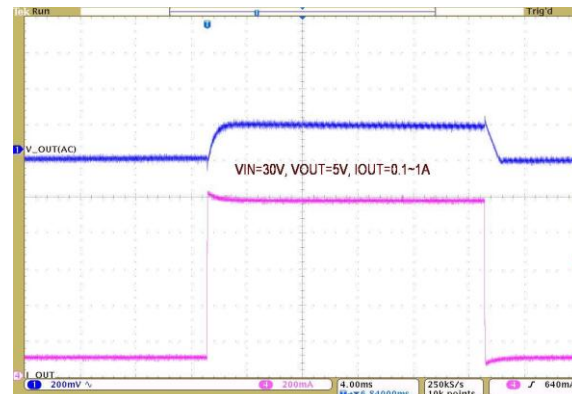

❖ TYPICAL CHARACTERISTICS (COUNTINOUS)

Load Transient (AX3015A)

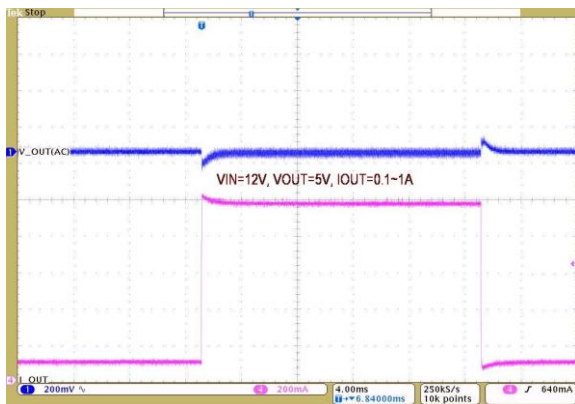

Load Transient (AX3015A)

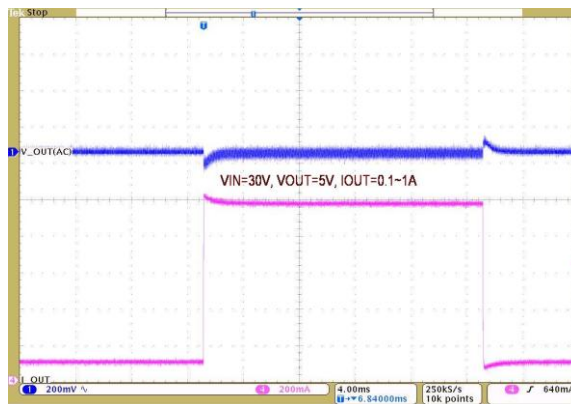

Load Transient (AX3015B)

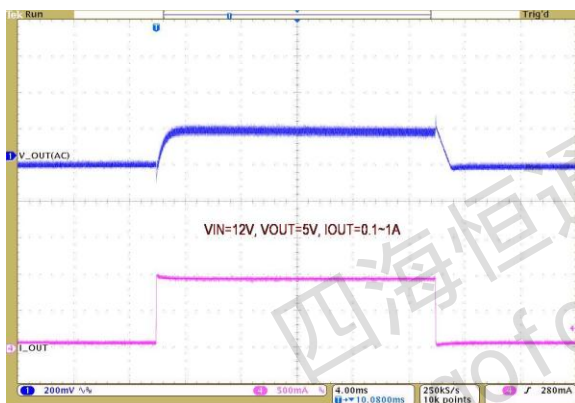

Load Transient (AX3015B)

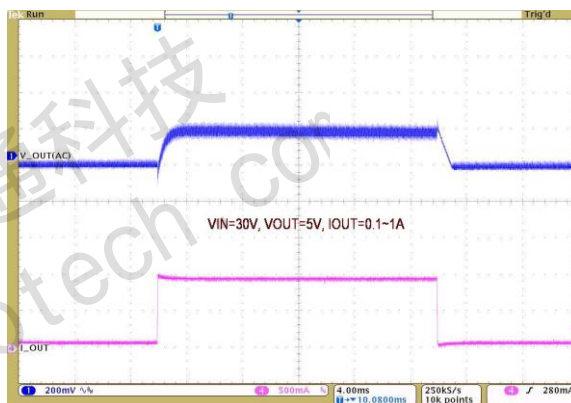

Load Transient (AX3015C)

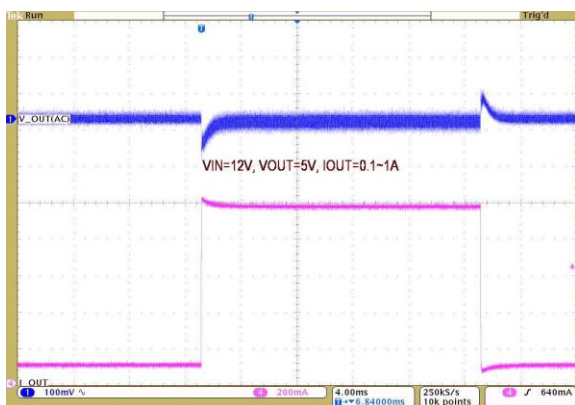

Load Transient (AX3015C)

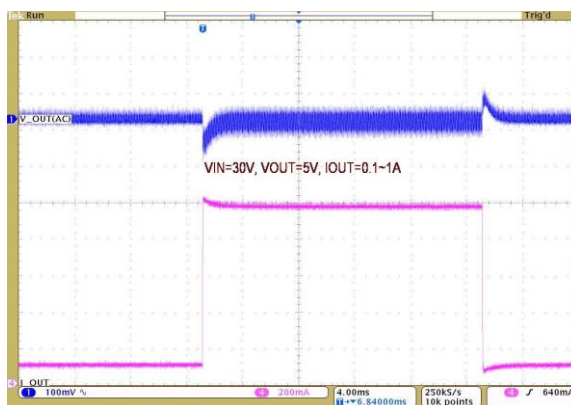

❖ PACKAGE OUTLINES

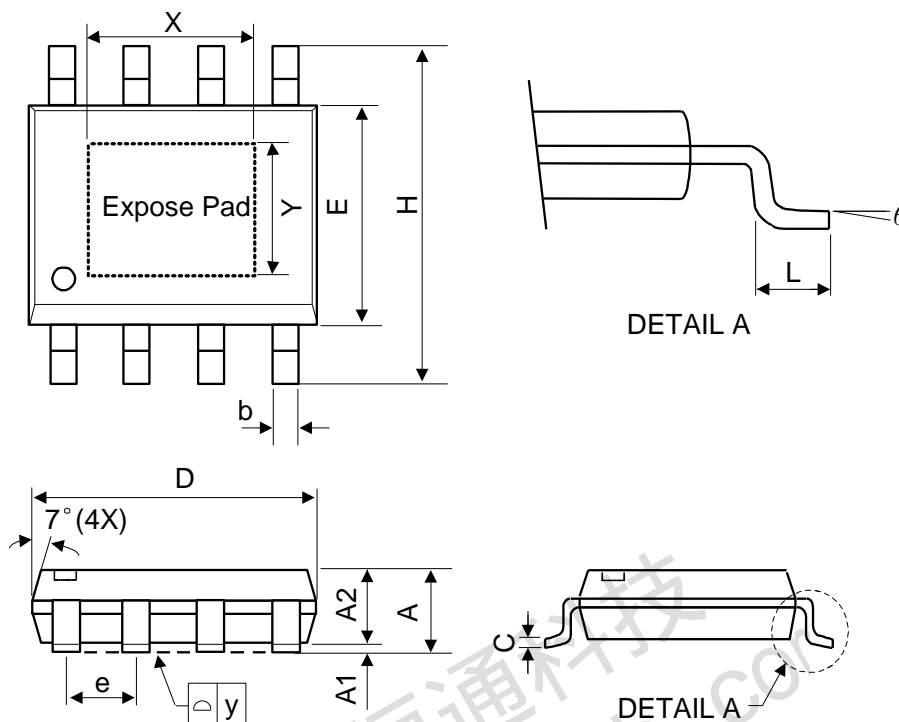

Symbol	Dimensions in Millimeters			Dimensions in Inches		
	Min.	Nom.	Max.	Min.	Nom.	Max.
A	-	-	1.75	-	-	0.069
A1	0	-	0.15	0	-	0.06
A2	1.25	-	-	0.049	-	-
C	0.1	0.2	0.25	0.0075	0.008	0.01
D	4.7	4.9	5.1	0.185	0.193	0.2
E	3.7	3.9	4.1	0.146	0.154	0.161
H	5.8	6	6.2	0.228	0.236	0.244
L	0.4	-	1.27	0.015	-	0.05
b	0.31	0.41	0.51	0.012	0.016	0.02
e	1.27 BSC			0.050 BSC		
y	-	-	0.1	-	-	0.004
X	-	2.34	-	-	0.092	-
Y	-	2.34	-	-	0.092	-
θ	0°	-	8°	0°	-	8°

Mold flash shall not exceed 0.25mm per side
JEDEC outline: MS-012 BA