

## **PWM Control 3A Step-Down Converter**

### ❖ GENERAL DESCRIPTION

AX3133 consists of step-down switching regulator with PWM control. These device include a reference voltage source, oscillation circuit, error amplifier, internal PMOS and etc.

AX3133 provides low-ripple power, high efficiency, and excellent transient characteristics. The PWM control circuit is able to the duty ratio linearly form 0 up to 100%. This converter is build out soft start function that prevents overshoot and inrush current at startup. An over current protect function and short circuit protect function are built inside, and when OCP or SCP happens, the operation frequency will be reduced. The operating frequency is decided by outside resistance. An external compensation is easily to system stable; the low ESR output capacitor can be used.

With the addition of an internal P-channel Power MOS, a coil, capacitors, and a diode connected externally, these ICs can function as step-down switching regulators. They serve as ideal power supply units for portable devices when coupled with the SOP-8L with exposed pad package, providing such outstanding features as low current consumption. Since this converter can accommodate an input voltage up to 32V, it is also suitable for the operation via an AC adapter.

### ❖ FEATURES

- Input voltage : 8V to 33V
- Output voltage : 3.3V to 26V
- Duty ratio : 0% to 100% PWM control
- Oscillation frequency range is 50K~350KHz by outside resistance setting
- Enable with Soft-Start function
- Current Limit, Short Circuit Protect (SCP) and Thermal Shutdown protection
- Built-in internal SW P-channel MOS.
- SOP-8L-EP Pb-Free package.

❖ BLOCK DIAGRAM

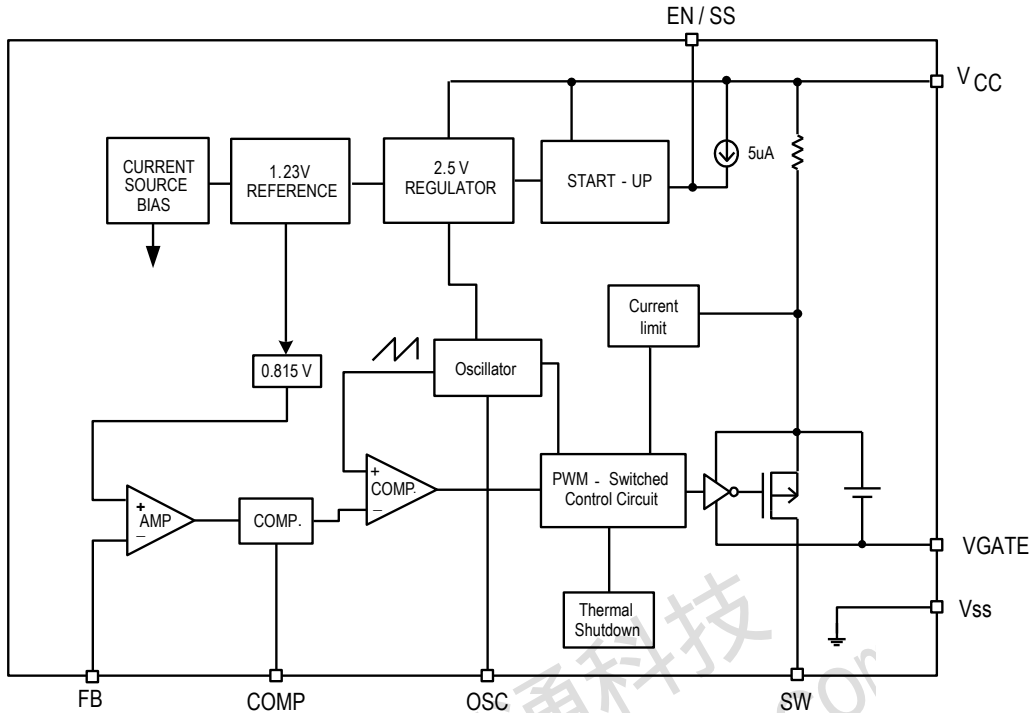

❖ PIN ASSIGNMENT

The package of AX3133 is SOP-8L-EP; the pin assignment is given by:

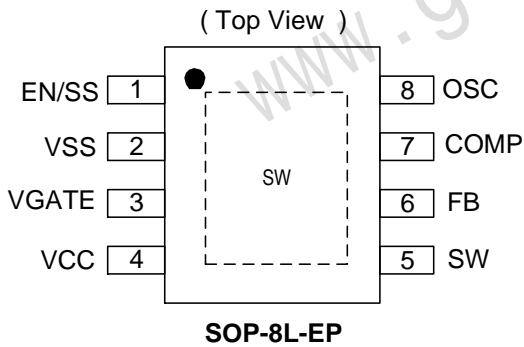

Name	Description
EN/SS	ON/OFF Shutdown and Soft-start pin
VSS	GND pin
VGATE	Driver GATE clamping pin. The pin must connect a 1uF capacitor to VCC
VCC	IC power supply pin
SW	Switch pin. Connect external inductor and diode here.
FB	Feedback pin
COMP	Compensation pin
OSC	Frequency Set Pin. The pin connect a resistance to GND.

❖ ORDER/MARKING INFORMATION

Order Information	Top Marking
<p><b>AX3133 XX X</b></p> <p>Package Type ES: SOP-8L-EP</p> <p>Packing Blank : Tube A : Taping</p>	<p>Logo ← <b>AX</b> 3 1 3 3 → Part number            YY WW X → ID code:internal                                → WW: 01~52                                → Year: 10=2010                                                11=2011</p>

❖ ABSOLUTE MAXIMUM RATINGS (at TA=25°C)

Characteristics	Symbol	Rating	Unit
VCC Pin Voltage	V <sub>CC</sub>	V <sub>SS</sub> - 0.3 to V <sub>SS</sub> + 36	V
Feedback Pin Voltage	V <sub>FB</sub>	V <sub>SS</sub> - 0.3 to 6	V
EN/SS Pin Voltage	V <sub>EN/SS</sub>	V <sub>SS</sub> - 0.3 to 6	V
OSC Pin Voltage	V <sub>OSC</sub>	V <sub>SS</sub> - 0.3 to 3	V
COMP Pin Voltage	V <sub>COMP</sub>	V <sub>SS</sub> - 0.3 to 6	V
VGATE Pin Voltage	V <sub>GATE</sub>	V <sub>SS</sub> - 0.3 to V <sub>CC</sub>	V
Switch Pin Voltage	V <sub>SW</sub>	V <sub>SS</sub> - 0.3 to V <sub>CC</sub> + 0.3	V
Power Dissipation	P <sub>D</sub>	Internally limited	mW
Storage Temperature Range	T <sub>ST</sub>	-65 to +150	°C
Operating Junction Temperature Range	T <sub>OJP</sub>	-40 to +125	°C
Operating Supply Voltage	V <sub>OP</sub>	8 to 32	V
Thermal Resistance from Junction to case	θ <sub>JC</sub>	15	°C/W
Thermal Resistance from Junction to ambient	θ <sub>JA</sub>	40	°C/W

Note: θ<sub>JA</sub> is measured with the PCB copper area (need connect to Exposed Pad) of approximately 1.5 in<sup>2</sup> (Multi-layer).

**❖ ELECTRICAL CHARACTERISTICS**

 (V<sub>CC</sub> = 12V, T<sub>A</sub>=25°C, unless otherwise specified)

Characteristics	Symbol	Conditions	Min	Typ	Max	Units
Feedback Voltage	V <sub>FB</sub>	V <sub>CC</sub> = 10V~32V I <sub>OUT</sub> = 0 to 2A T <sub>j</sub> =-20°C ~125°C	0.800	0.815	0.830	V
Quiescent Current	I <sub>CCQ</sub>	V <sub>FB</sub> =1.2V force driver off	-	3	6	mA
Feedback Bias Current	I <sub>FB</sub>	I <sub>OUT</sub> =0.1A	-	0.1	0.5	uA
Shutdown Supply Current	I <sub>SD</sub>	V <sub>EN/SS</sub> =0V	-	3	6	mA
Current Limit	I <sub>CL</sub>		3.3	-	-	A
Adjustable frequency range	F <sub>OSC</sub>		50	-	380	KHz
Short frequency	F <sub>OSC1</sub>	V <sub>CC</sub> = 10V~32V	45	50	55	KHz
EN/SS Pin Shutdown Logic input threshold voltage	V <sub>ENL</sub>		-	-	0.8	V
EN/SS Pull high Current	I <sub>EN/SS</sub>	V <sub>EN/SS</sub> =0V	-	5	-	uA
Internal MOSFET R <sub>DS(ON)</sub>	R <sub>DS(ON)</sub>	V <sub>CC</sub> =12V, V <sub>FB</sub> =0V	-	60	110	mΩ
Efficiency	EFFI	V <sub>CC</sub> = 12V, V <sub>OUT</sub> = 5V, I <sub>OUT</sub> = 2A	-	91	-	%
		V <sub>CC</sub> = 28V, V <sub>OUT</sub> = 5V, I <sub>OUT</sub> = 2A		87		

❖ APPLICATION CIRCUIT

EL cap

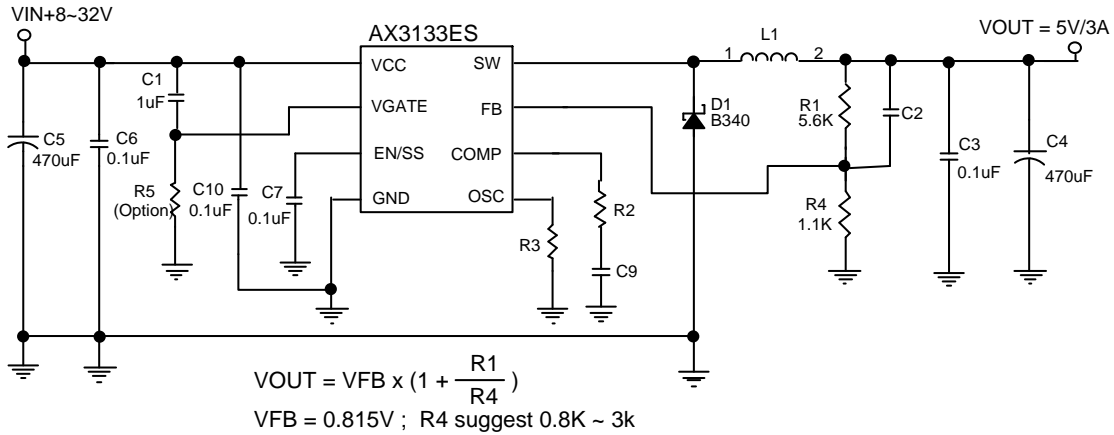

Compensation Table						
COUT ESR Range	Frequency(Hz)	VIN RANGE	R2	C9	C2	L1
30m~80mΩ	50K	8~30V	100R	4n7	3300p	100u
	150K		100R	4n7	1500p	68u
	250K		470R	10n	1500p	33u
	350K		470R	1n	680p	22u
80m~300mΩ	50K		100R	4n7	3300p	100u
	150K		100R	4n7	820p	68u
	250K		470R	10n	1500p	33u
	350K		100R	4n7	180p	22u

❖ FUNCTION DESCRIPTIONS

EN/SS

This pin can be supplied shutdown or soft start function. It is inside pull high function. For normal application, the pin must be connected a capacitor to ground. There is a 5uA current to charge this capacitor, vary the different capacitor value to control soft start time. Allow the switching regulator circuit to be shutdown pulling this pin below a 0.8V threshold voltage.

## OSC

External frequency set pin. The pin connects a resistance (R3) to reduce system frequency. This converter's frequency can be set from 50K to 350KHz, please refer the below table to set frequency.

T=Room Temperature				
R3 (Ω)	10M	240K	110K	68K
Frequency (Hz)	52K	150K	250K	350K

## COMP

Compensation pin. For EL output capacitor application, the COMP pin connects R2 and C9 to ground for all condition; please refer the compensation table.

## ❖ APPLICATION INFORMATION

### Setting the Output Voltage

Application circuit item shows the basic application circuit with adjustable output version. The external resistor sets the output voltage according to the following equation:

$$V_{OUT} = 0.815V \times \left(1 + \frac{R1}{R4}\right)$$

Table 1 Resistor select for output voltage setting

V <sub>OUT</sub>	R4	R1
5V	1.1K	5.6K
3.3V	2.7K	8.2K

### Inductor Selection

For most designs, the different frequency can be reducing the inductor value; The AX3133 is suggested 22μH to 100μH for 350K to 50KHz frequencies. Please refer the below table to design.

L1 recommend value (V <sub>IN</sub> =8~32V, V <sub>OUT</sub> =5V, I <sub>OUT</sub> =3A)				
Frequency (Hz)	50K	150K	250K	350K
L1 Value (H)	100uH	68uH	33uH	22uH

Where is inductor Ripple Current. Large value inductors lower ripple current and small value inductors result in high ripple currents. Choose inductor ripple current approximately 20% of the maximum load current 3A,  $\Delta I_L=0.6A$ . The DC current rating of the inductor should be at least equal to the maximum load current plus half the ripple current to prevent core saturation ( $3A+0.3A$ ).

### Input Capacitor Selection

This capacitor should be located close to the IC using short leads and the voltage rating should be approximately 1.5 times the maximum input voltage. The RMS current rating requirement for the input capacitor of a buck regulator is approximately 1/2 the DC load current. A low ESR input capacitor sized for maximum RMS current must be used. A 470 $\mu$ F low ESR capacitor for most applications is sufficient.

### Output Capacitor Selection

The output capacitor is required to filter the output and provide regulator loop stability. The important capacitor parameters are; the 100 KHz Equivalent Series Resistance (ESR), the RMS ripples current rating, voltage rating, and capacitance value. For the output capacitor, the ESR value is the most important parameter. The ESR can be calculated from the following formula.

$$V_{RIPPLE} = \Delta I_L \times ESR = 0.6A \times 80m\Omega = 48mV$$

An aluminum electrolytic capacitor's ESR value is related to the capacitance and its voltage rating. In most case, higher voltage electrolytic capacitors have lower ESR values. Most of the time, capacitors with much higher voltage ratings may be needed to provide the low ESR values required for low output ripple voltage. It is recommended to replace this low ESR capacitor by using a 470 $\mu$ F low ESR values  $< 80m\Omega$ .

❖ TYPICAL CHARACTERISTICS

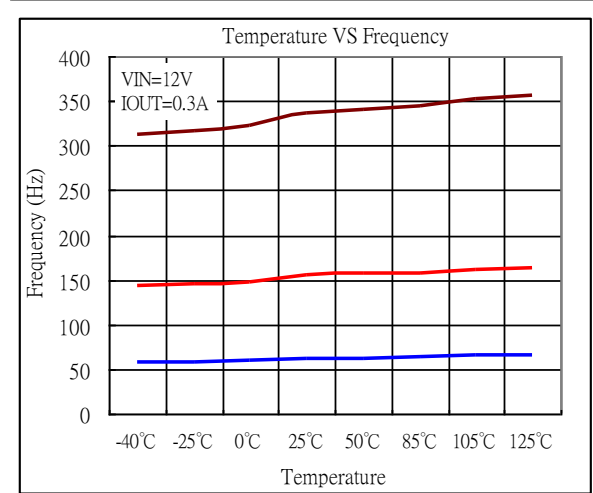
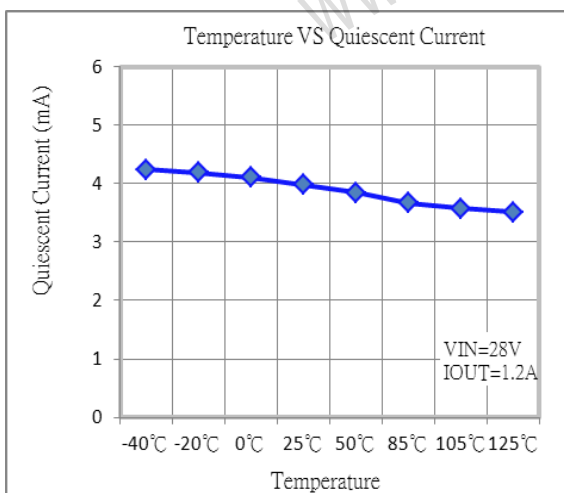
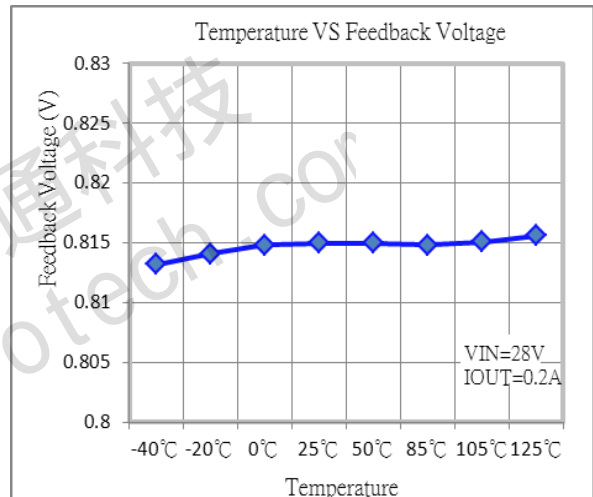
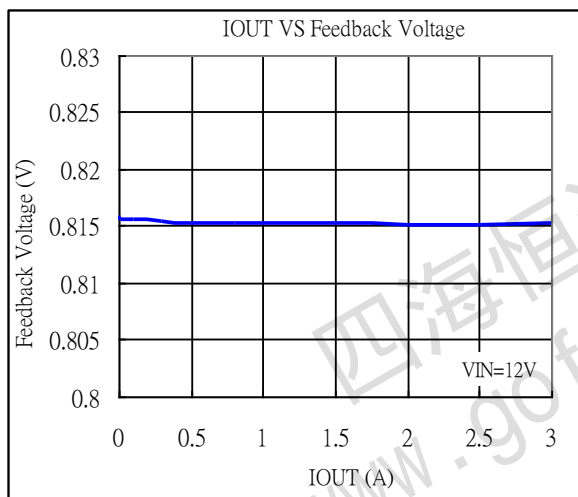
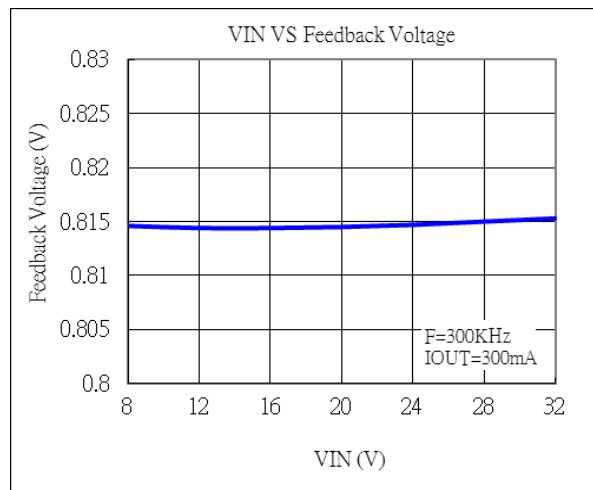
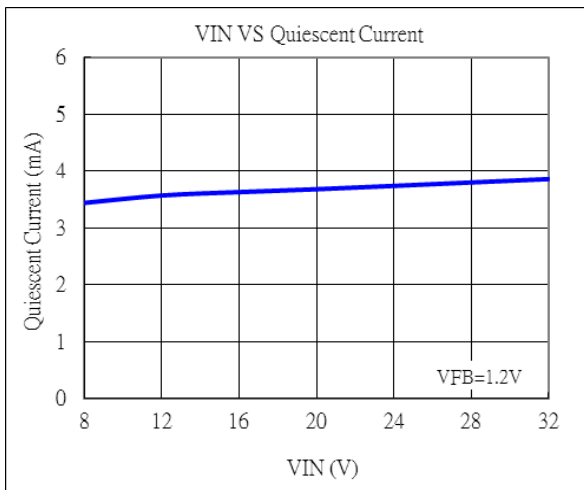



❖ TYPICAL CHARACTERISTICS (CONTINUOUS)

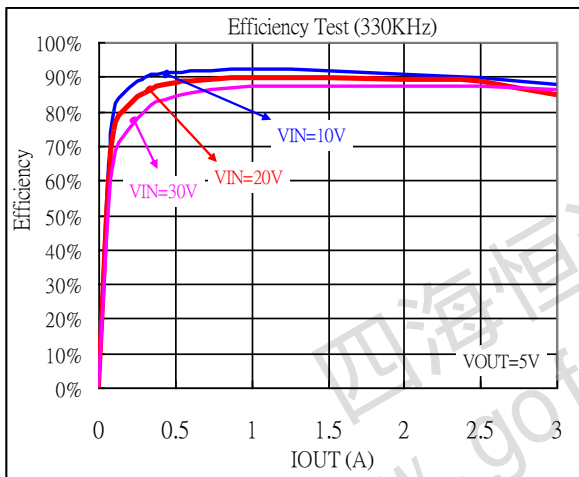
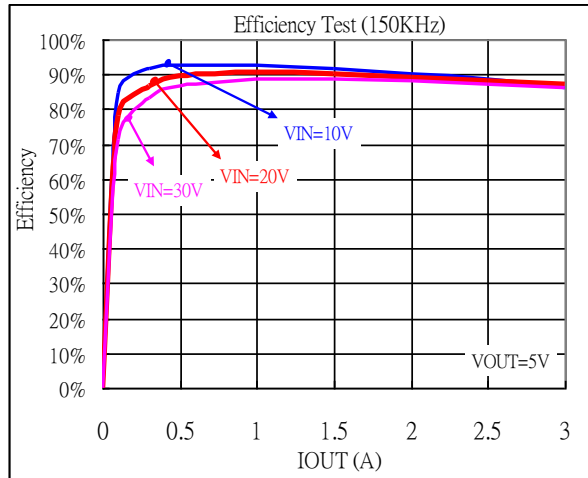
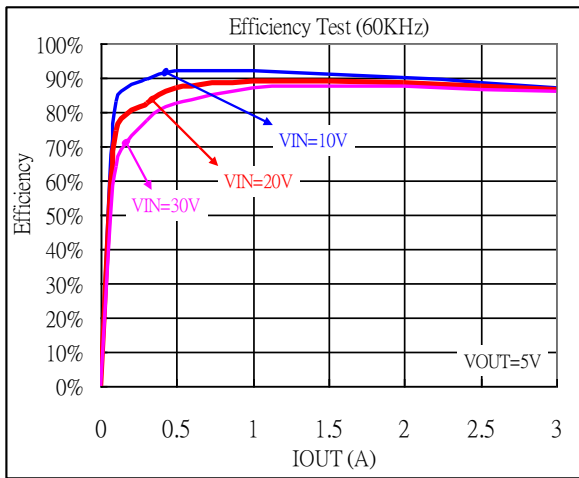

www.gototech.com

❖ **TYPICAL CHARACTERISTICS (CONTINUOUS)**

Power-ON Wave (F=60KHz)  
( $V_{IN}=12V, V_{OUT}=5V, Load=2A, C_{EN/SS}=0.1\mu F$ )

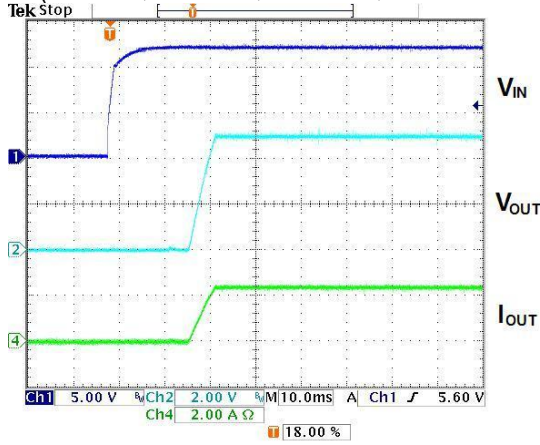

Power-ON Wave (F=60KHz)  
( $V_{IN}=24V, V_{OUT}=5V, Load=2A, C_{EN/SS}=0.1\mu F$ )

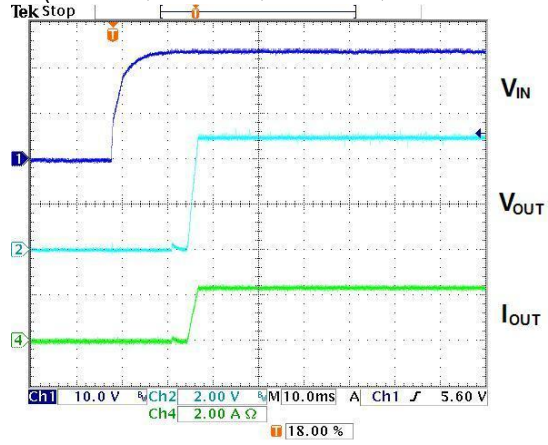

Enable-ON Wave (60KHz)  
( $V_{IN}=12V, V_{OUT}=5V, Load=2A, C_{EN/SS}=0.1\mu F$ )

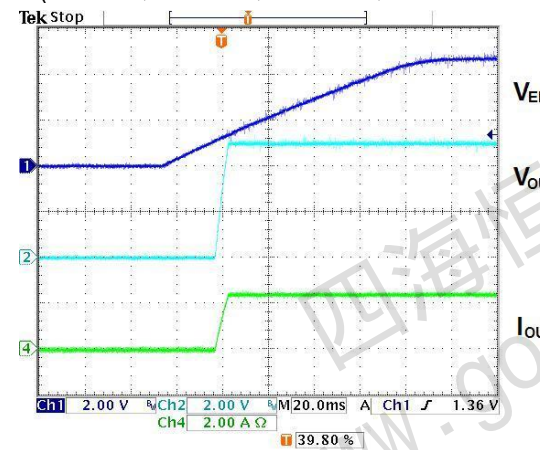

Enable-ON Wave (60KHz)  
( $V_{IN}=24V, V_{OUT}=5V, Load=2A, C_{EN/SS}=0.1\mu F$ )

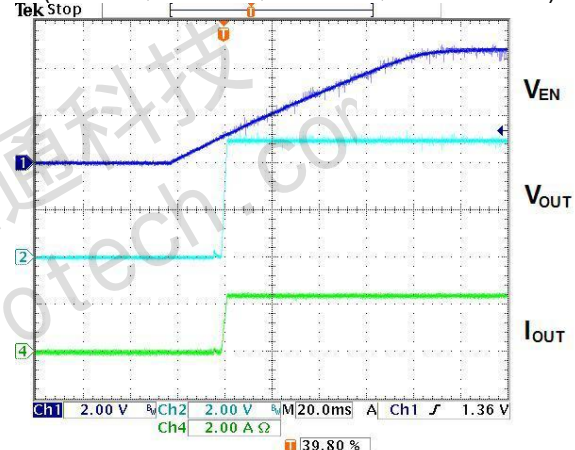

Load Transient (F=60KHz)  
( $V_{IN}=12V, V_{OUT}=5V, Load=0.3\sim 2.7A$ )

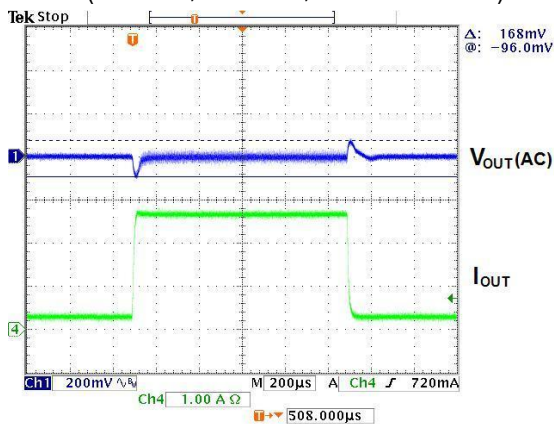

Load Transient (F=60KHz)  
( $V_{IN}=24V, V_{OUT}=5V, Load=0.3\sim 2.7A$ )

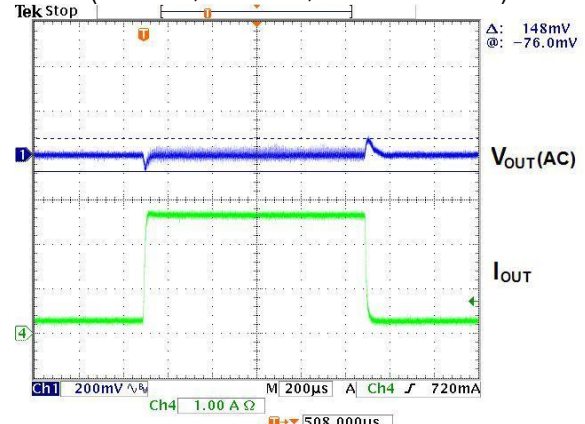

❖ PACKAGE OUTLINES

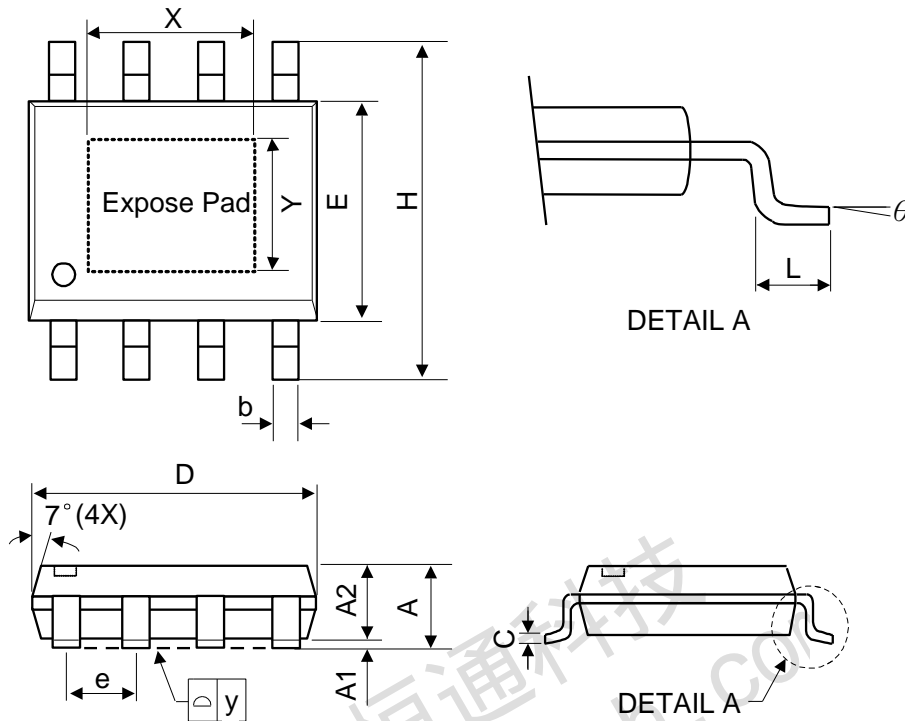

Symbol	Dimensions in Millimeters			Dimensions in Inches		
	Min.	Nom.	Max.	Min.	Nom.	Max.
A	-	-	1.75	-	-	0.069
A1	0	-	0.15	0	-	0.06
A2	1.25	-	-	0.049	-	-
C	0.1	0.2	0.25	0.0075	0.008	0.01
D	4.7	4.9	5.1	0.185	0.193	0.2
E	3.7	3.9	4.1	0.146	0.154	0.161
H	5.8	6	6.2	0.228	0.236	0.244
L	0.4	-	1.27	0.015	-	0.05
b	0.31	0.41	0.51	0.012	0.016	0.02
e	1.27 BSC			0.050 BSC		
y	-	-	0.1	-	-	0.004
X	-	2.34	-	-	0.092	-
Y	-	2.34	-	-	0.092	-
θ	0°	-	8°	0°	-	8°

Mold flash shall not exceed 0.25mm per side  
JEDEC outline: MS-012 BA